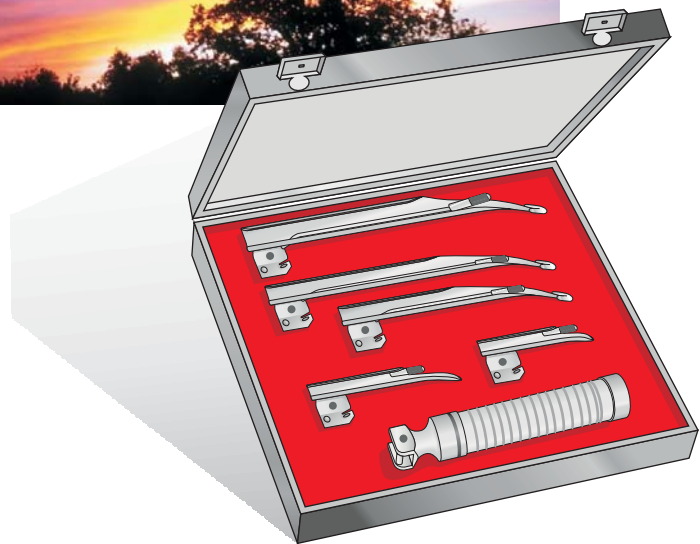


**Bmed**  
Chirurgische Instrumente



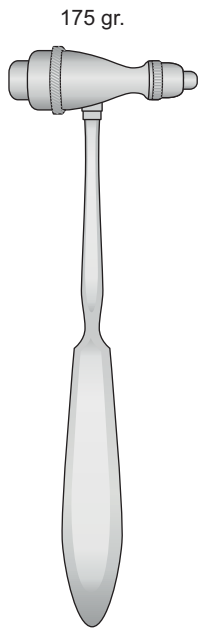




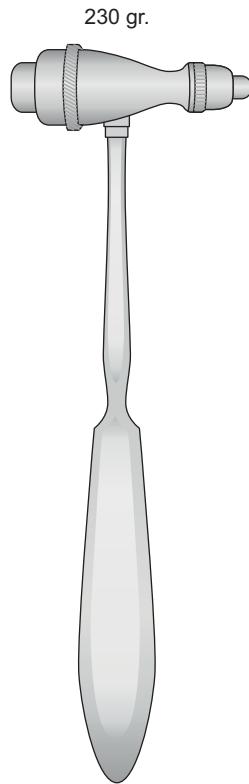
1

Diagnostica, Anestesia  
Diagnostics, Anesthesia  
Diagnostik, Anaesthesie  
Diagnostic, Anesthésie  
Diagnòstico, Anestesia

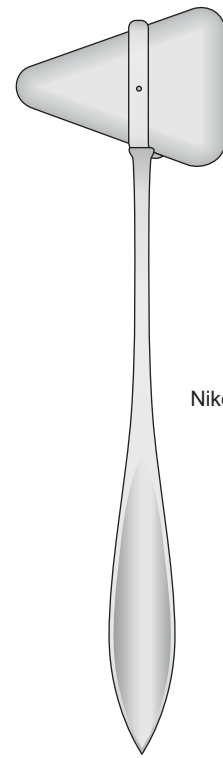




TROEMNER  
**AB-16**  
140 mm



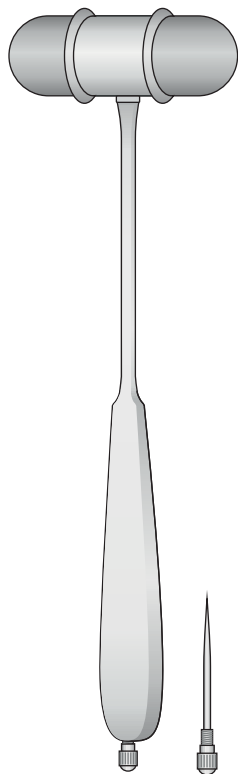
TROEMNER  
**AB-18**  
240 mm



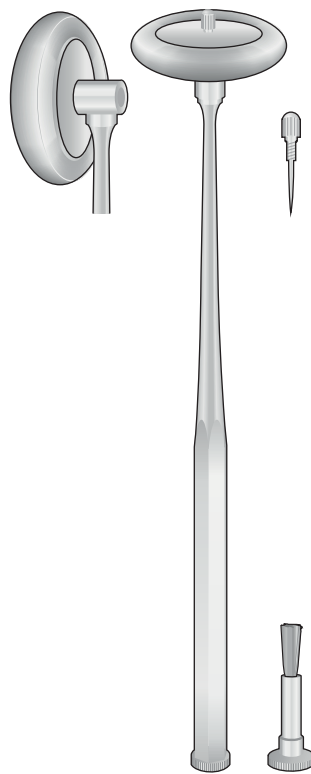
TAYLOR  
**AB-14**  
200 mm

Nikel-Chrom

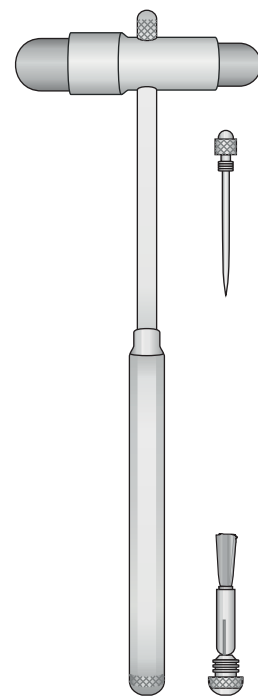
Con ago - With pin  
Mit Nadel - Avec aiguille  
Con aguja



DEJERINE  
**AB-10**  
200 mm



BABINSKY  
**AB-11**  
255 mm



BUCK  
**AB-12**  
180 mm



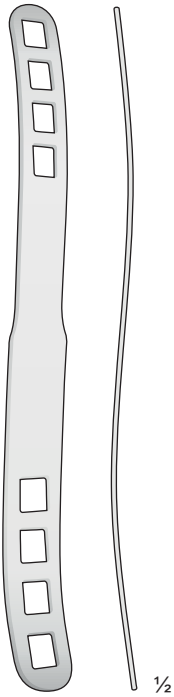
Abbassalingua

Tongue depressor

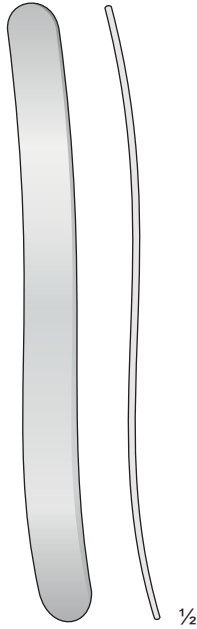
Zungenspatel

Abaisse-langues

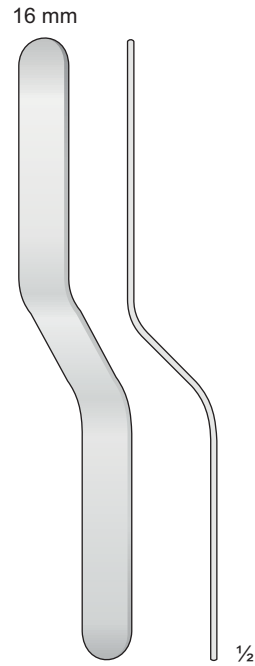
Bejalenguas



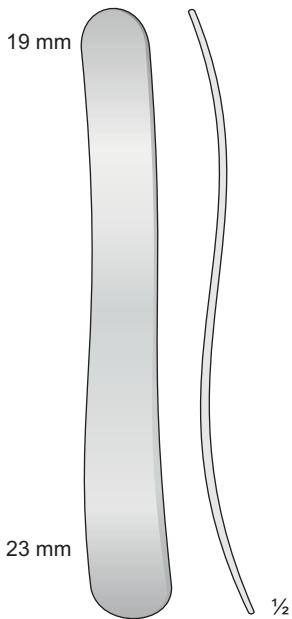
**BRUENINGS  
OM-04**  
190 mm



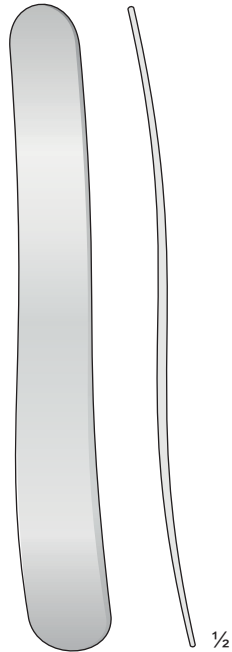
**OM-05**  
145 mm



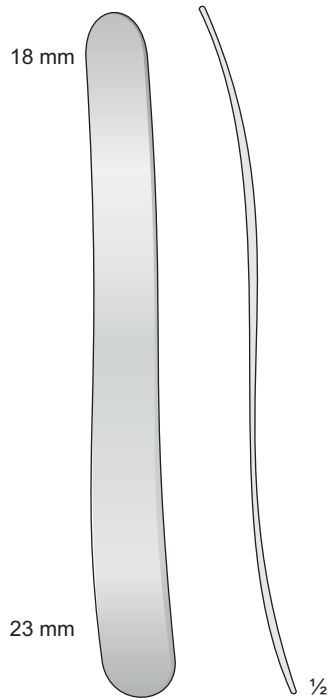
**OM-07**  
145 mm



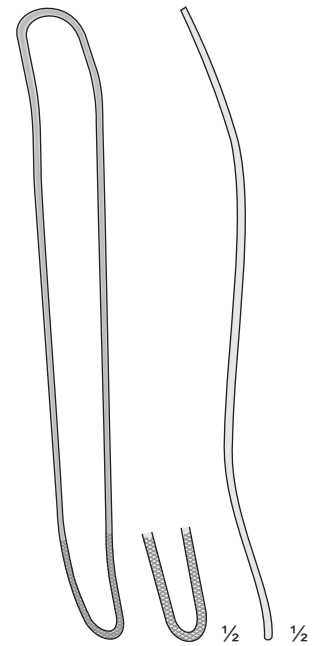
**KROENIG  
OM-16**  
150 mm



**MAYO  
OM-17**  
170 mm



**BUCHWALD  
OM-18**  
180 mm



**FRENZEL  
OM-19**  
165 mm

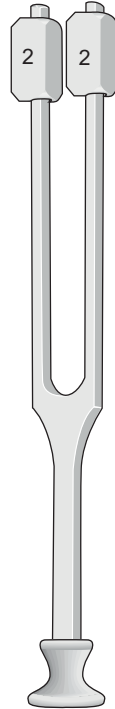


a<sup>1</sup> 440

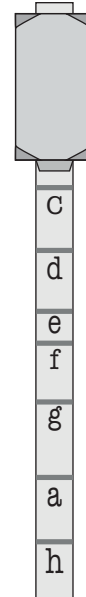


**AC-20**

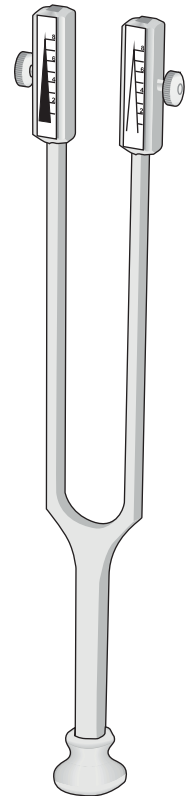
C 128



**LUCAE  
AC-30**



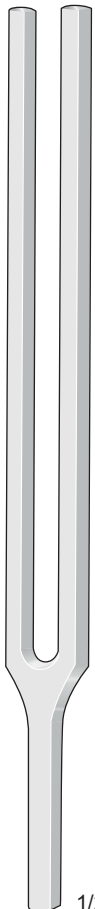
C 64 / C 128



**RYDEL-SEIFER  
AC-40**

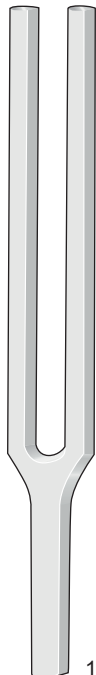
C 64  
Con smorzatore - With clamps  
Mit Dämpfer - Avec curseurs  
C 128  
Senza smorzatore - Without clamps  
Ohne Dämpfer - Sans curseurs

C 128



**HARTMANN  
AC-11**

C<sup>1</sup> 256



**HARTMANN  
AC-12**

C<sup>2</sup> 512



**HARTMANN  
AC-13**

C<sup>3</sup> 1024



**HARTMANN  
AC-14**

C<sup>4</sup> 2048

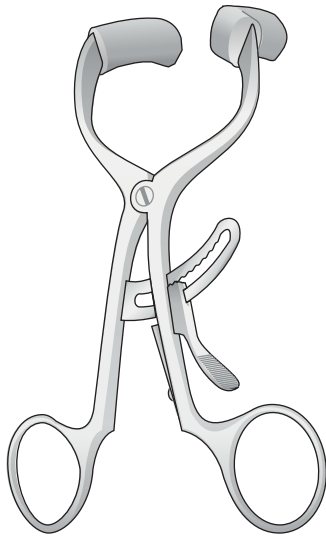


**HARTMANN  
AC-15**

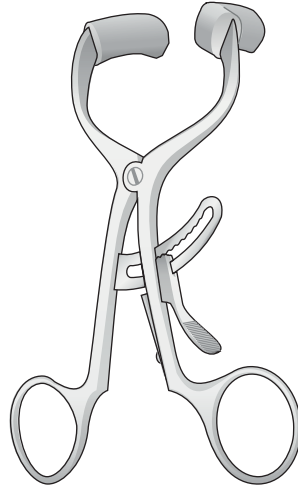
C<sup>5</sup> 4096



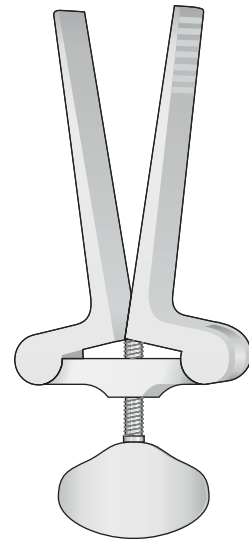
**HARTMANN  
AC-16**



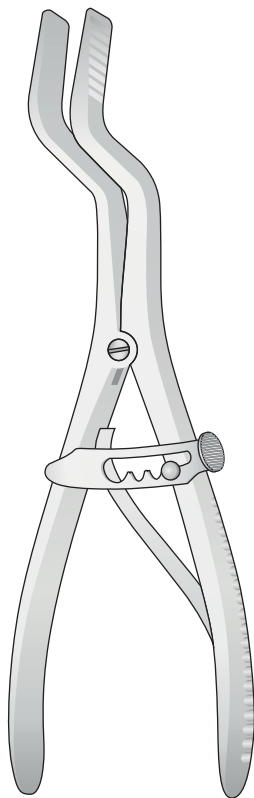
DOYEN-JANSEN  
**OM-41**  
140 mm



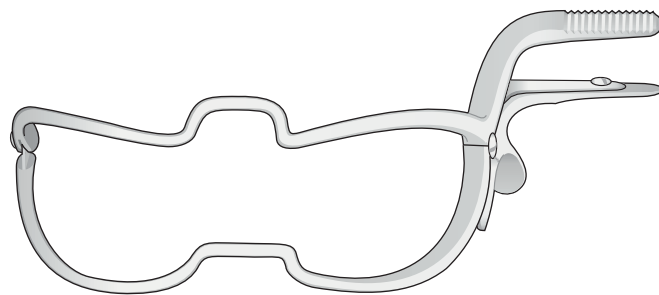
DOYEN-COLLIN  
**OM-40**  
120 mm



HEISTER  
**OM-62**  
135 mm



ROSER-KÖNIG  
**OM-60**  
185 mm



WHITEHEAD-JENNINGS  
**OM-136** 90 mm  
**OM-137** 110 mm  
**OM-138** 130 mm  
**OM-139** 150 mm





Pinze tiralingua

Tongueforceps

Zungenzangen

Pinces tire-langue

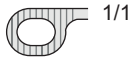
Pinzas tira-lengua

Anestesia - Anesthesia  
Anaesthesia - Anesthésie - Anestesia



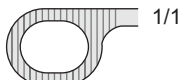
1/1

**OM-12**  
150 mm



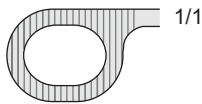
1/1

**OM-13**  
200 mm



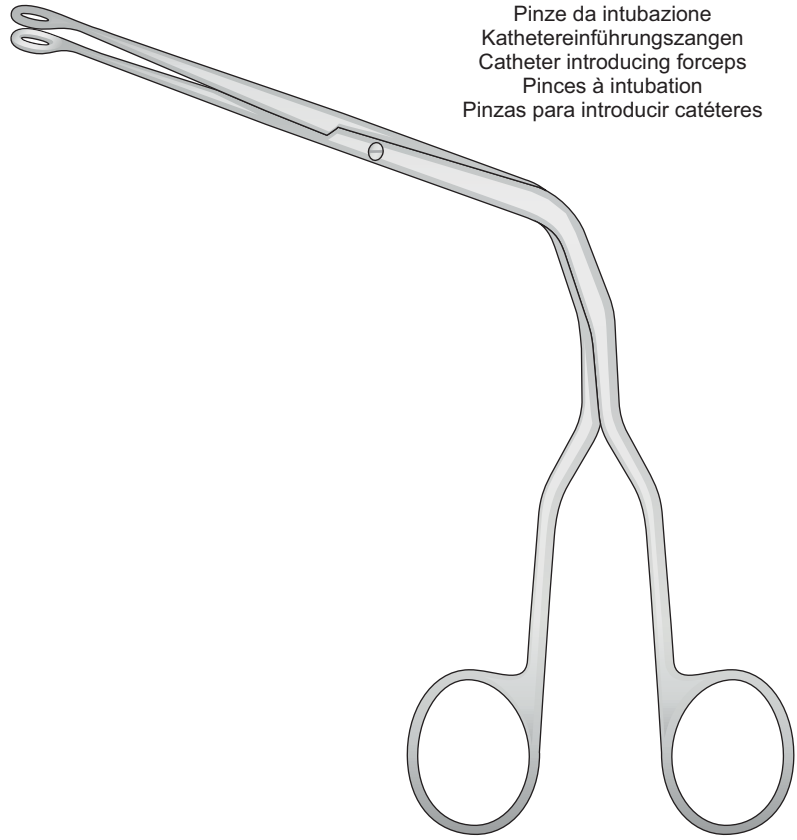
1/1

**OM-14**  
250 mm



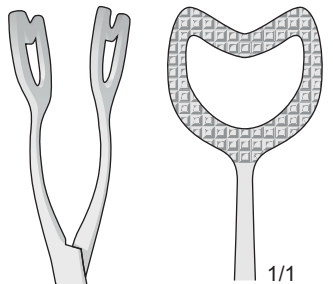
1/1

**OM-15**  
250 mm

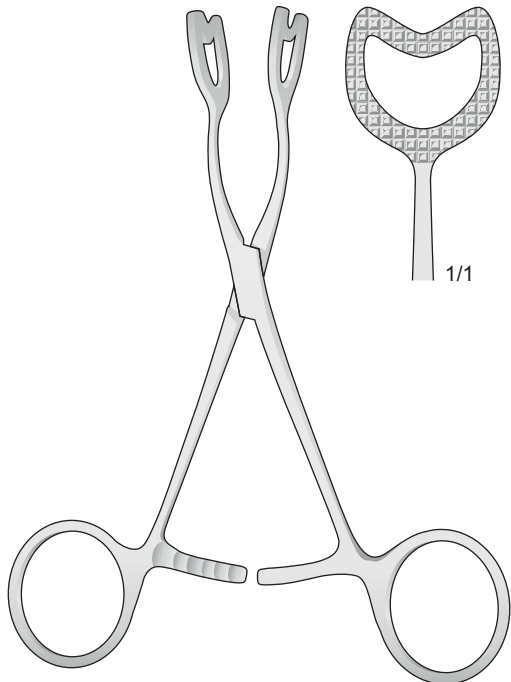


Pinze da intubazione  
Kathetereinführungszangen  
Catheter introducing forceps  
Pinces à intubation  
Pinzas para introducir catéteres

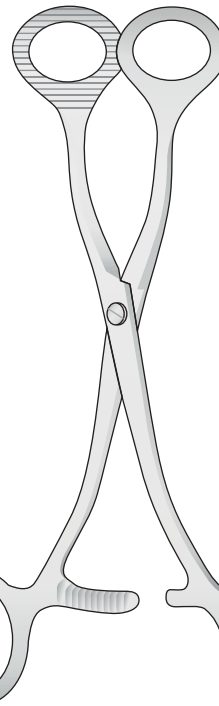
MAGILL  
**OM-12/OM-15**



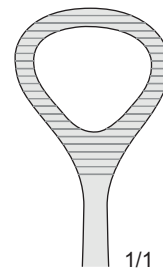
1/1



**OM-11**  
140 mm

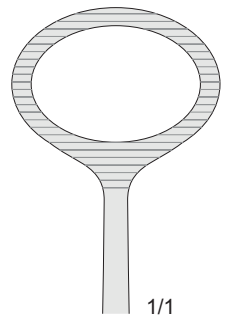


COLLIN  
**OM-10/OM-30**



1/1

**OM-30**  
165 mm

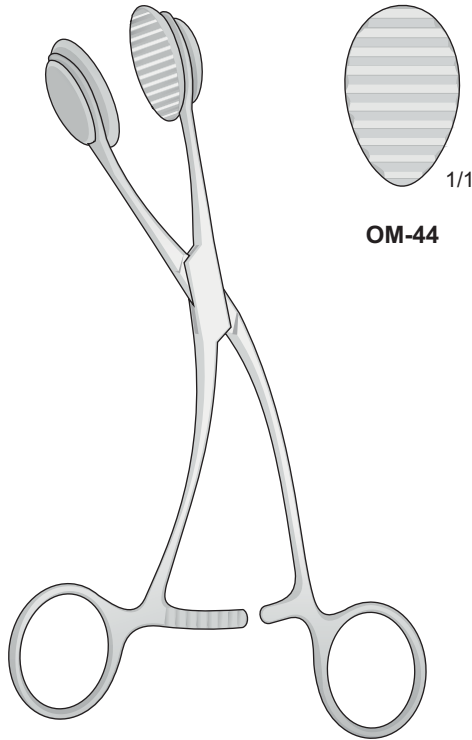


1/1

**OM-10**  
170 mm

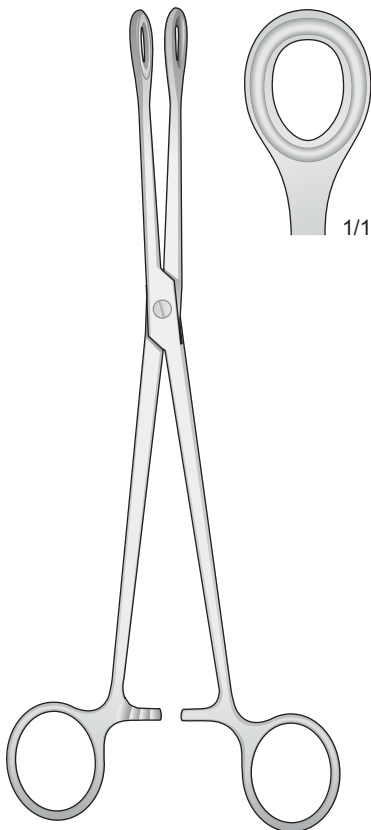


Gomini di ricambio 2 pezzi  
 1 Pair of rubber pads  
 1 Paar ersatzgummi  
 1 Paire de mors caoutchouc  
 1 Paar placas de caucho



**OM-44**

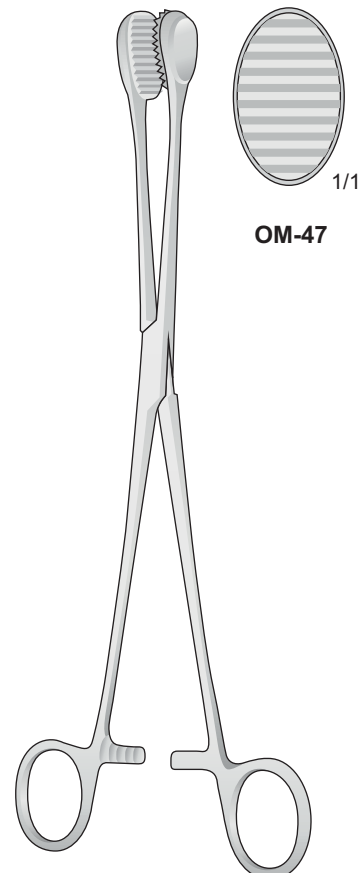
Pinza per batuffoli e tamponi  
 Cotton swab-Sponge holding forceps  
 Tupfer-Schwammzangen  
 Pincés à tampons et è ponges  
 Pinzas para tampones porta esponjas



**BF-16**  
230 mm

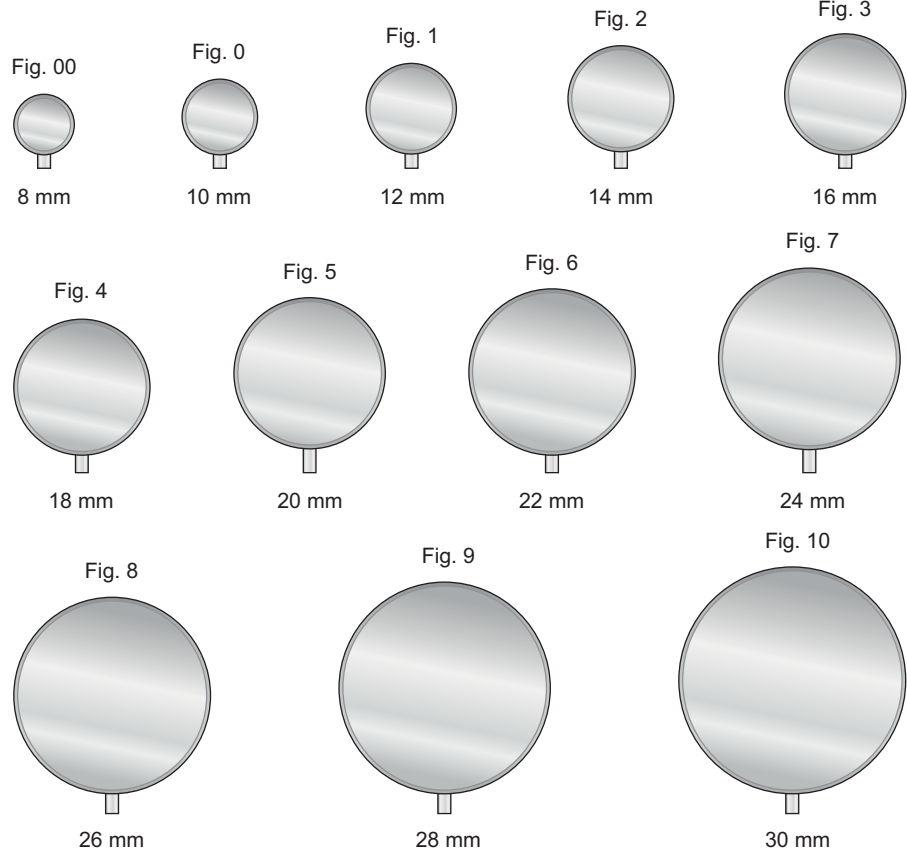
YOUNG  
**OM-45**  
 160 mm

Gomini di ricambio 2 pezzi  
 1 Pair of rubber pads  
 1 Paar ersatzgummi  
 1 Paire de mors caoutchouc  
 1 Paar placas de caucho



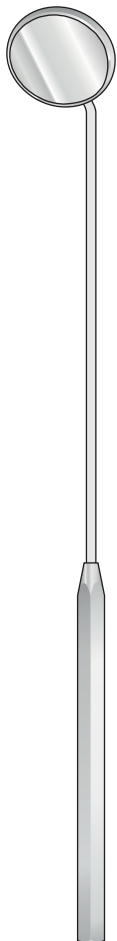
**OM-47**

CHILD  
**OM-46**  
 240 mm



Specchietto laringeo con manico esagonale  
 Kehlkopfspiegel mit Sechskantgriff  
 Laryngeal mirrors with hexagonal handle  
 Miroirs laryngiens avec manche hexagonal

Inox

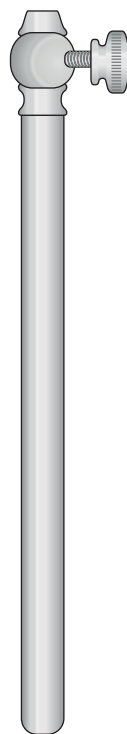


G-8/G-30  
180 mm

Diametro dello specchio - Diameter of mirrors - Spiegeldurchmesser  
 Diamètre des miroirs - Diámetro de los espejos

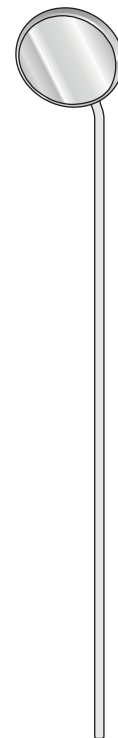
Manico per specchietti  
 Mirrors handle  
 Spiegelgriff  
 Manche à miroir  
 Manico para espejos

Nikel-Chrom



MA-6  
120 mm

Specchietto laringeo  
 Laryngeal mirrors  
 Kehlkopfspiegel  
 Miroirs laryngiens  
 Espejos laringeos



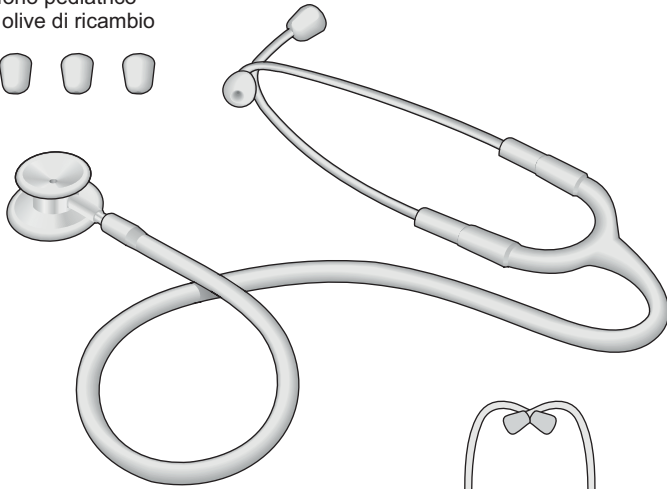
P-00/P-06  
120 mm

	Fig.
G- 8	00
G-10	0
G-12	1
G-14	2
G-16	3
G-18	4
G-20	5
G-22	6
G-24	7
G-26	8
G-28	9
G-30	10

	Fig.
P-00	00
P- 0	0
P-01	1
P-02	2
P-03	3
P-04	4
P-05	5
P-06	6

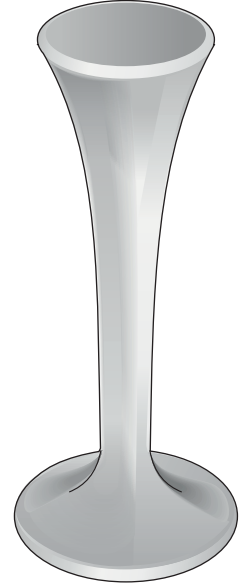


Duofono pediatrico  
Con 4 olive di ricambio

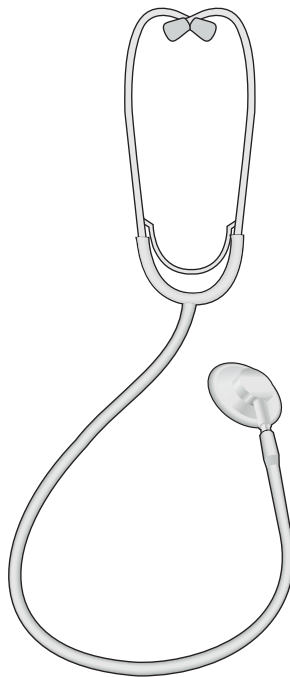


**AB-54**

In legno  
Of wood  
Aus Holz  
En bois  
De madera

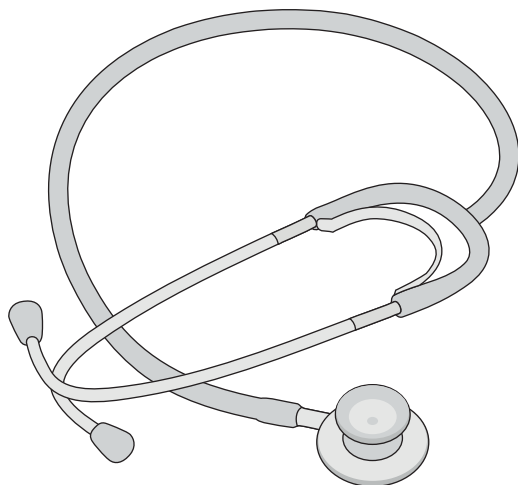


**AB-55**  
145 mm



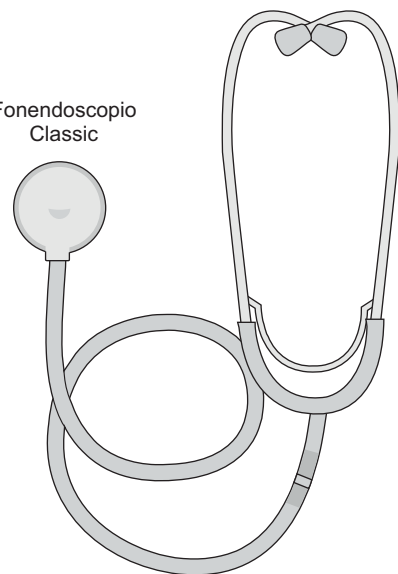
LEVIS - CLASSIC  
**AB-52**

Professional  
Con 4 olive di ricambio



**AB-50**

Fonendoscopio  
Classic



**AB-51**



Laringoscopio  
MC INTOSH



**AA-B100**

2,5 Volt  
300 mA

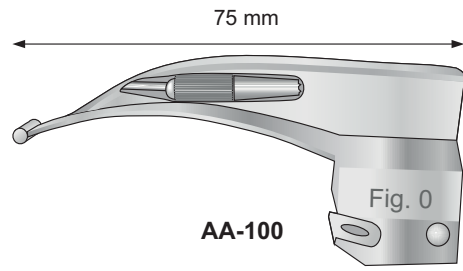
Per lama **AA-100**  
For blades **AA-100**  
Für Spatel **AA-100**  
Pour spatules **AA-100**  
Para hojas **AA-100**



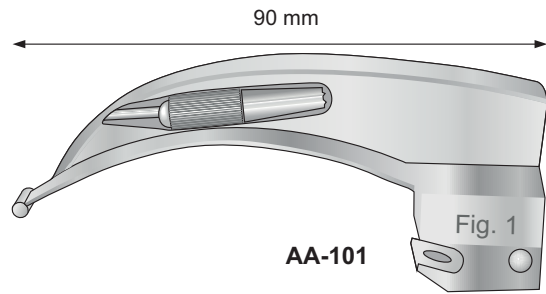
**AA-B101**

2,5 Volt  
300 mA

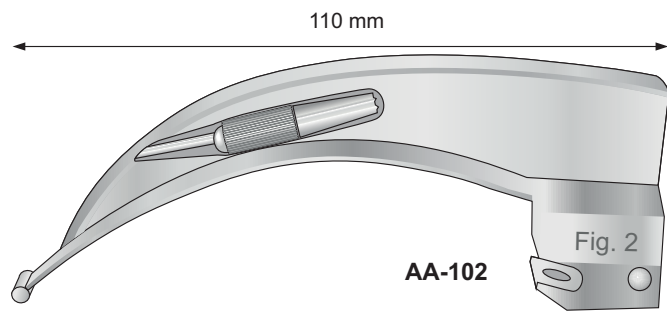
Per lame **AA-101 ÷ AA-104**  
For blades **AA-101 ÷ AA-104**  
Für Spatel **AA-101 ÷ AA-104**  
Pour spatules **AA-101 ÷ AA-104**  
Para hojas **AA-101 ÷ AA-104**



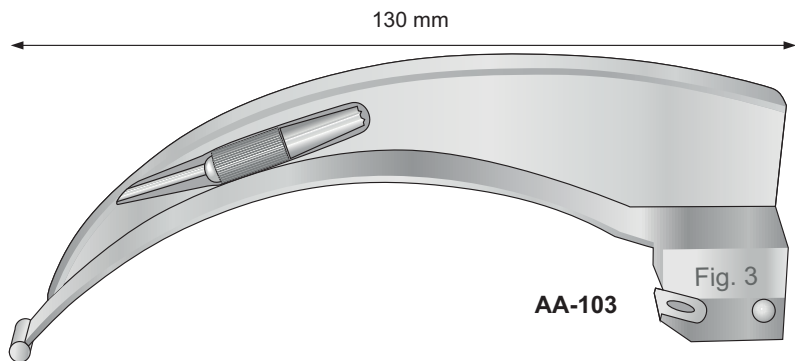
**AA-100**



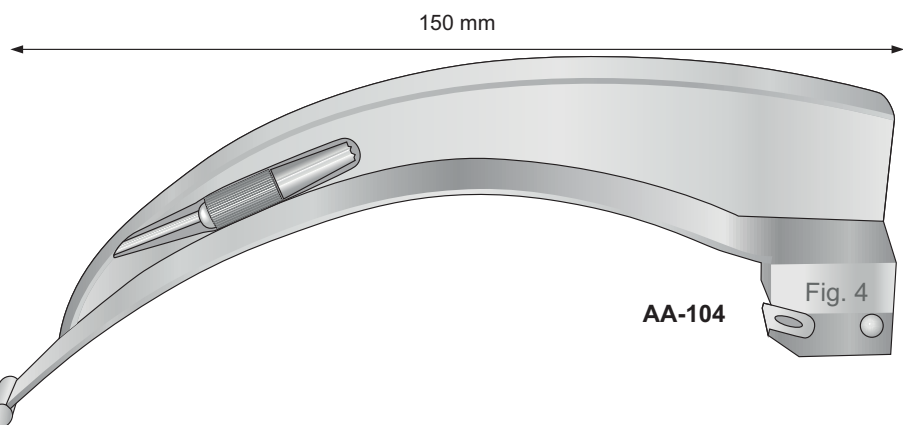
**AA-101**



**AA-102**



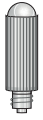
**AA-103**



**AA-104**



Laringoscopia  
**MILLER**



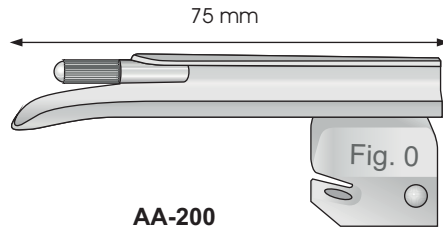
**AA-B100**  
2,5 Volt  
300 mA

Per lame **AA-200 + AA-203**  
For blades **AA-200 + AA-203**  
Für Spatel **AA-200 + AA-203**  
Pour spatules **AA-200 + AA-203**  
Para hojas **AA-200 + AA-203**

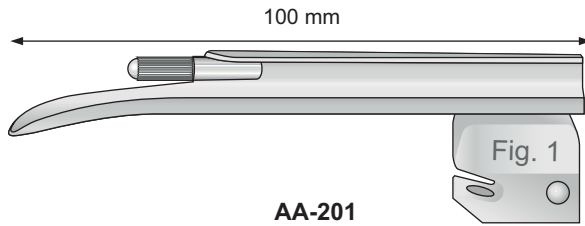


**AA-B101**  
2,5 Volt  
300 mA

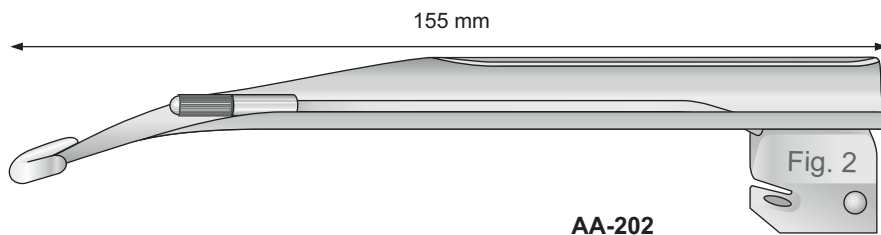
Per lama **AA-204**  
For blades **AA-204**  
Für Spatel **AA-204**  
Pour spatules **AA-204**  
Para hojas **AA-204**



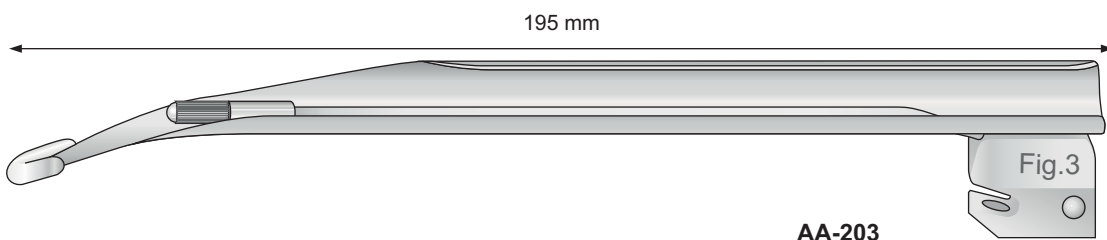
**AA-200**



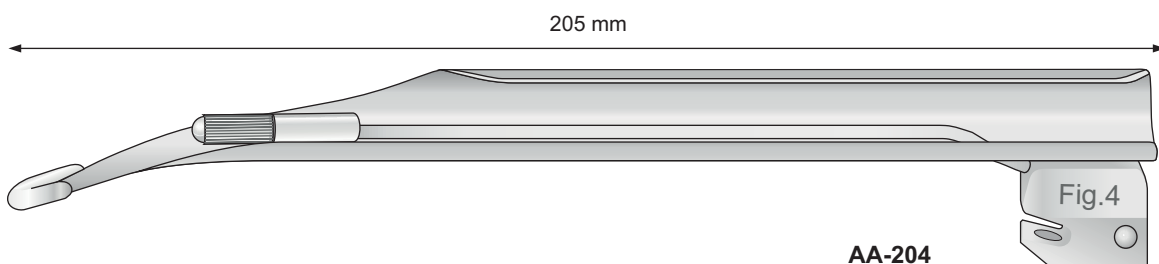
**AA-201**



**AA-202**



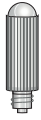
**AA-203**



**AA-204**



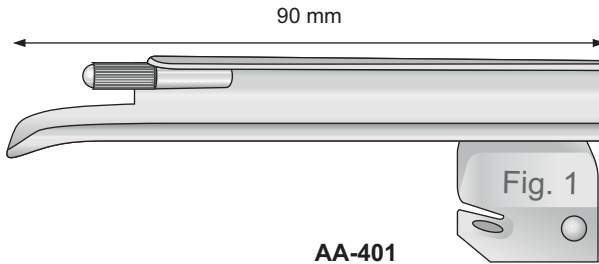
Laringoscopia  
**NEGUS - GUEDEL**



**AA-B100**

2,5 Volt  
300 mA

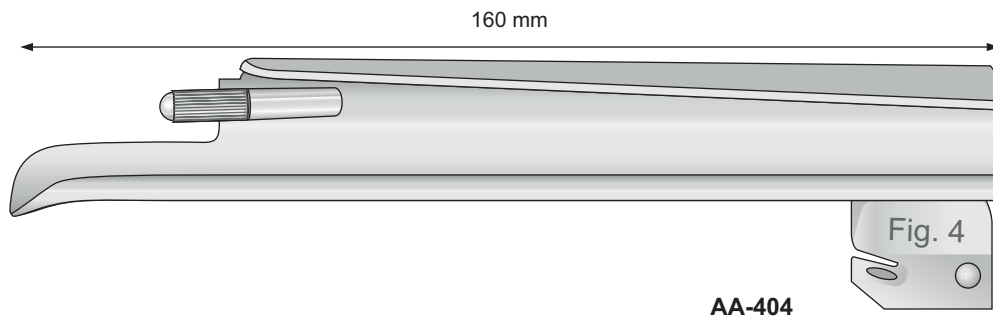
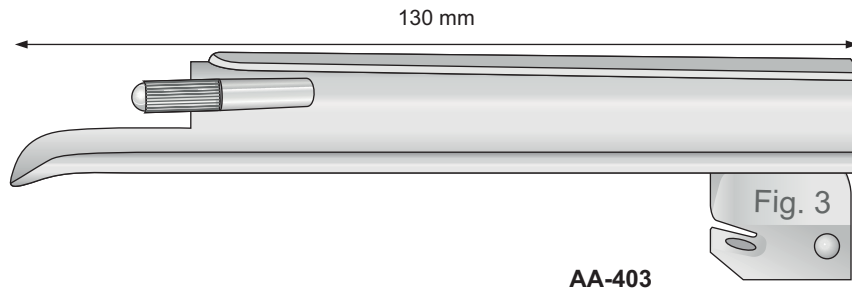
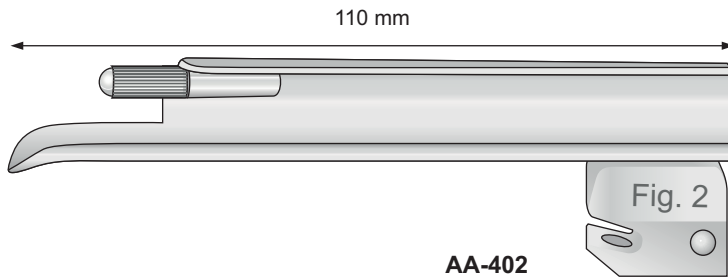
Per lama **AA-401**  
For blades **AA-401**  
Für Spatel **AA-401**  
Pour spatules **AA-401**  
Para hojas **AA-401**



**AA-B101**

2,5 Volt  
300 mA

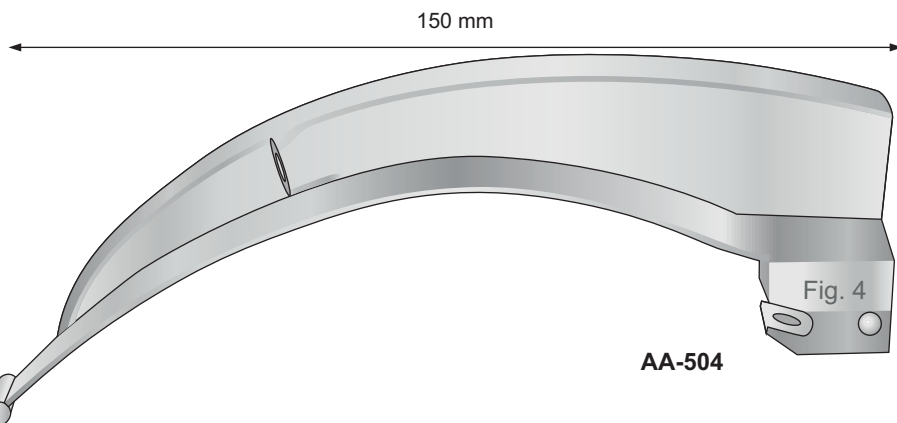
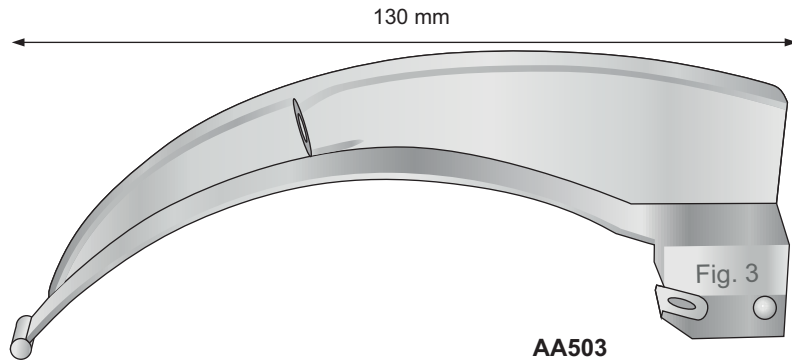
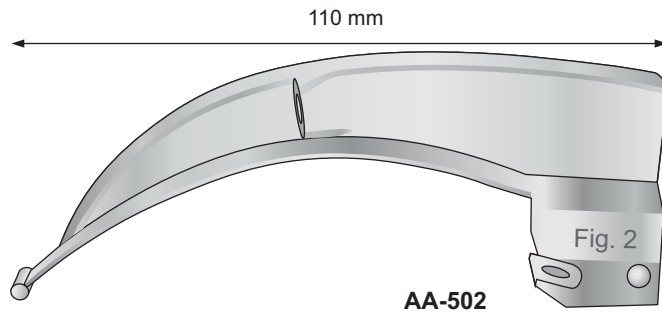
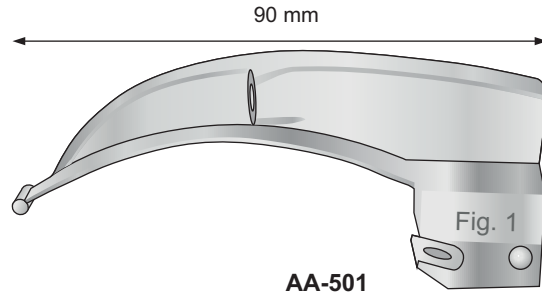
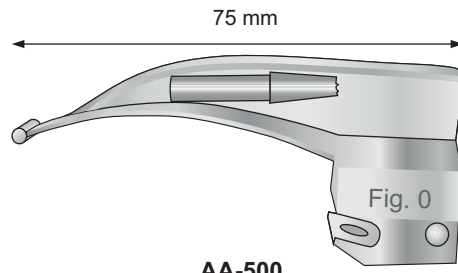
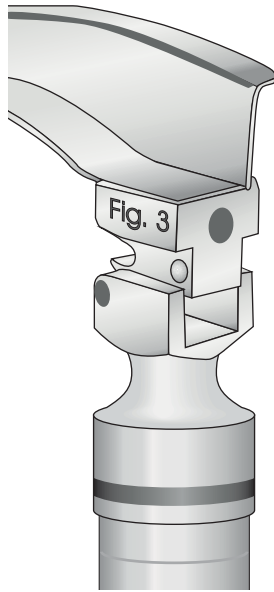
Per lame **AA-402 ÷ AA-404**  
For blades **AA-402 ÷ AA-404**  
Für Spatel **AA-402 ÷ AA-404**  
Pour spatules **AA-402 ÷ AA-404**  
Para hojas **AA-402 ÷ AA-404**





Laringoscopia  
**MC INTOSH**

Fibre ottiche  
Fiberoptic

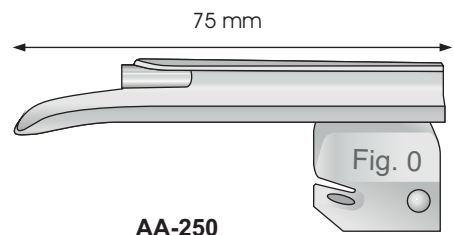




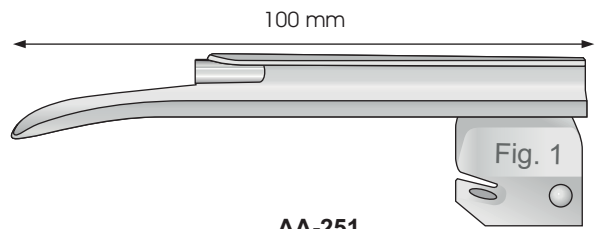


Laringoscopio  
**MILLER**

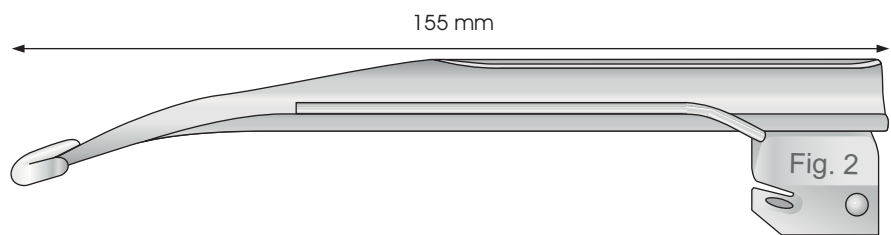
Fibre ottiche  
Fiberoptic



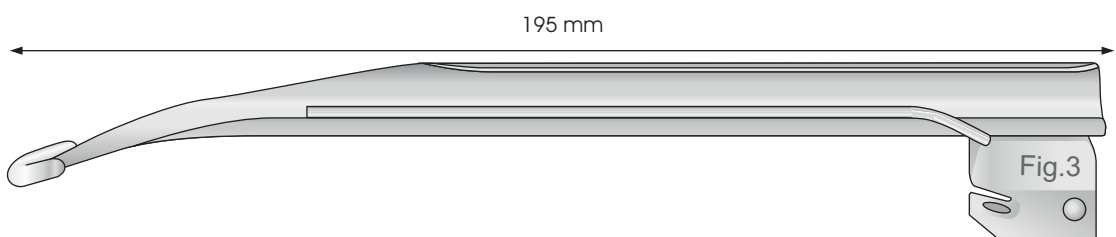
**AA-250**



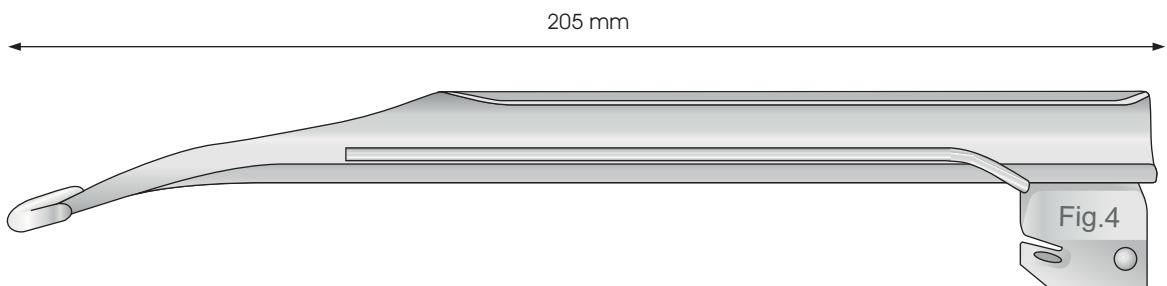
**AA-251**



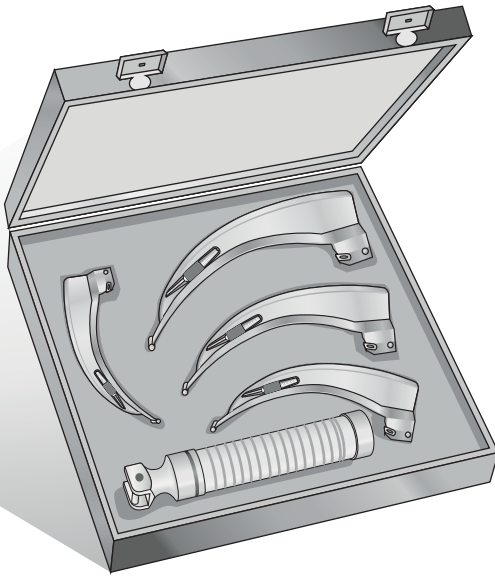
**AA-252**



**AA-253**



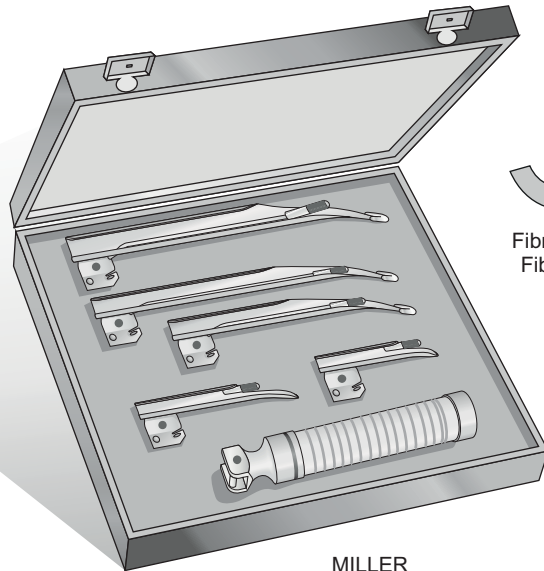
**AA-254**



Mc INTOSH  
**AA-S103** - Set 3 lame  
**AA-S104** - Set 4 lame  
**AA-S105** - Set 5 lame

MILLER  
**AA-S203** - Set 3 lame  
**AA-S204** - Set 4 lame  
**AA-S205** - Set 5 lame

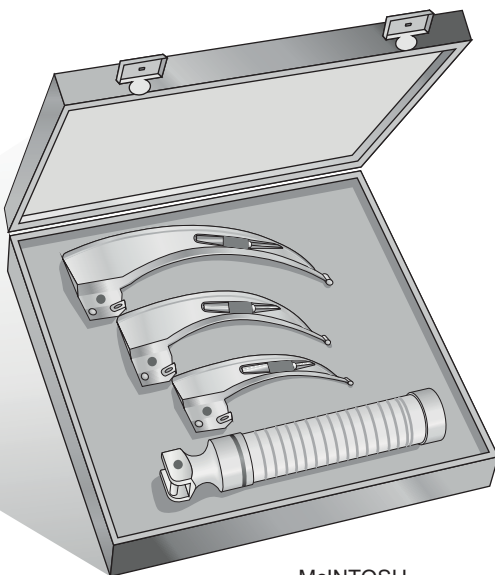
NEGUS-GUEDEL  
**AA-S403** - Set 3 lame  
**AA-S404** - Set 4 lame



Fibre ottiche  
Fiber optic

MILLER  
**AA-S255**

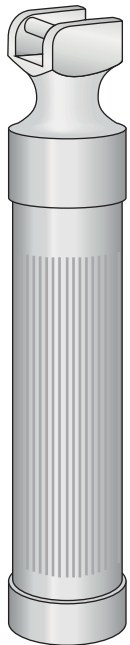
MILLER  
**Fibre ottiche**  
**AA-S253** - Set 3 lame  
**AA-S254** - Set 4 lame  
**AA-S255** - Set 5 lame



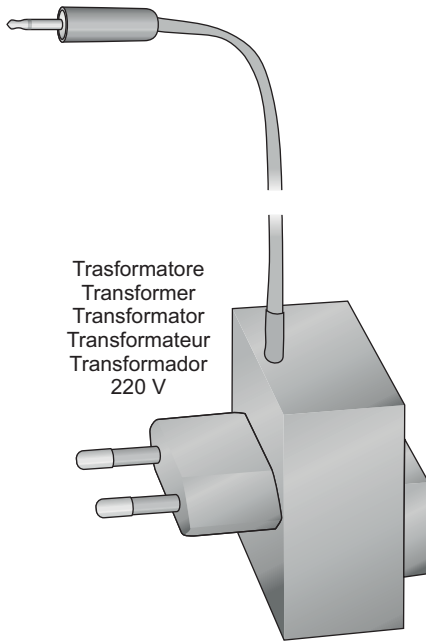
Fibre ottiche  
Fiber optic

McINTOSH  
**AA-S503**

Mc INTOSH  
**Fibre ottiche**  
**AA-S503** - Set 3 lame  
**AA-S504** - Set 4 lame  
**AA-S505** - Set 5 lame

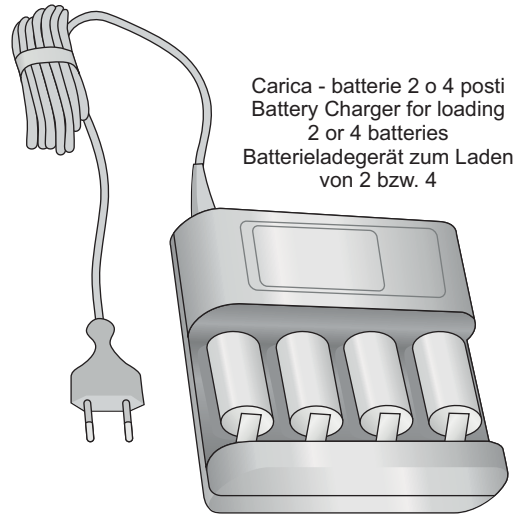


**AA-T60**  
Ø 30 mm



Trasformatore  
Transformer  
Transformator  
Transformateur  
Transformador  
220 V

**AA-151**



Carica - batterie 2 o 4 posti  
Battery Charger for loading  
2 or 4 batteries  
Batterieladegerät zum Laden  
von 2 bzw. 4

**AA-153**

Lampada alogene  
Halogen lamp  
Halogenlampe  
Lampe halogène  
Làmpara Houlógeno



**AA-130**  
640 mA

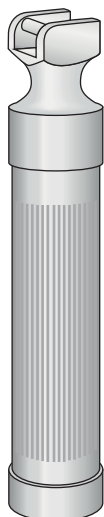


**AA-B100**  
2,5 Volt  
300 mA

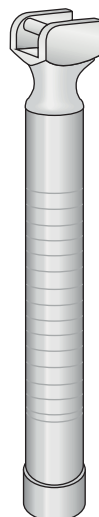


**AA-B101**  
2,5 Volt  
300 mA

Manico in Acciaio Inossidabile - Handles of stainless steel - Griffe aus Rostfreiem Edelstahl



**AA-70**  
Ø 30 mm

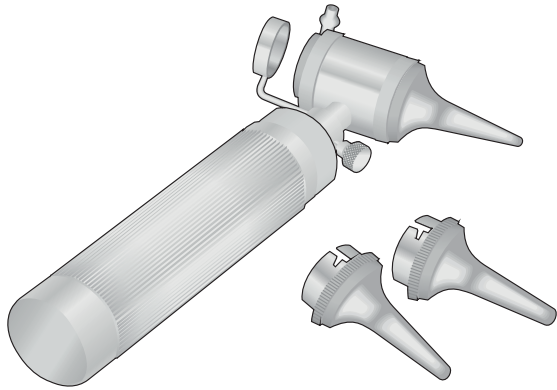


**AA-80**  
Ø 18 mm

Manico Fibre ottiche  
Fiberoptic Handle  
Kaltlichtgriff

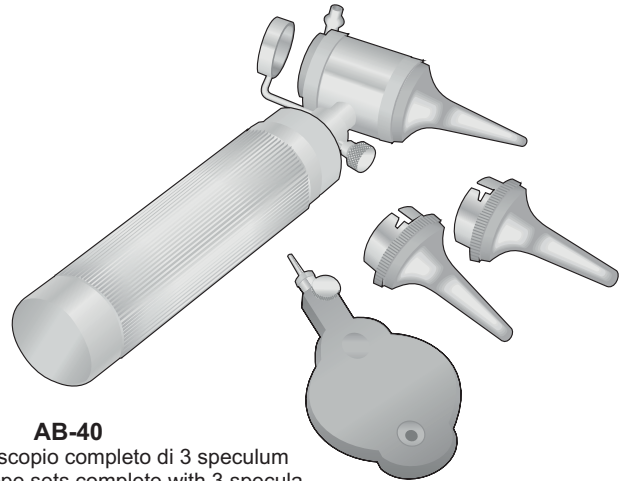


**AA-90H**  
Ø 30 mm



**AB-32**

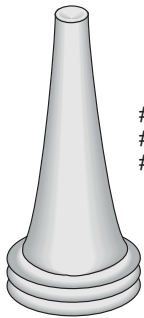
Otoscopio completo di 3 speculum e scatola  
 Otoloscope complete with 3 specula and box  
 Otoskop-Besteck komplett mit 3 Ohrtrichtern in Etui  
 Trousse à otoscopie complète avec  
 3 spéculums auriculaires en boîte



**AB-40**

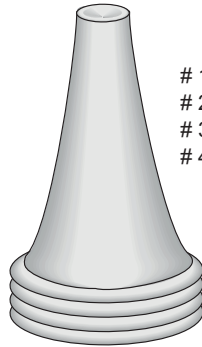
Set Oto-oftalmoscopio completo di 3 speculum  
 Oto-Ophthalmoscope sets complete with 3 specula  
 Oto-Ophthalmoskop mit 3 Ohrtrichtern  
 Trousse à oto-ophtalmoscopie avec  
 3 spéculums auriculaires

Speculum in Nylon  
 Nero - Black - Schwarz  
 Noir - Negro

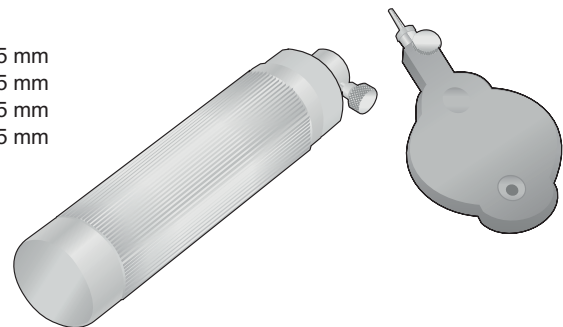


# 1 - Ø 3,0 mm  
 # 2 - Ø 4,5 mm  
 # 3 - Ø 5,5 mm

Speculum per adulti  
 Specula for adults  
 Spekulum für Erwachsene  
 Spéculum pour adultes  
 Especula para adultos



# 1 - **AB-04** - Ø 4,5 mm  
 # 2 - **AB-05** - Ø 5,5 mm  
 # 3 - **AB-06** - Ø 6,5 mm  
 # 4 - **AB-07** - Ø 7,5 mm



**AB-32R**

Set 3 pezzi  
 Set of 3  
 Satz zu 3  
 Jeu de 3  
 Juego de 3  
 Fig. 1-3

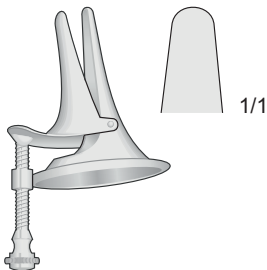
**HARTMANN**

**AB-09**

Set 4 pezzi  
 Set of 4  
 Satz zu 4  
 Jeu de 4  
 Juego de 4  
 Fig. 1-4

**AB-34**

Oftalmoscopio  
 Ophthalmoscope  
 Ophthalmoskop  
 Ophtalmoscopie



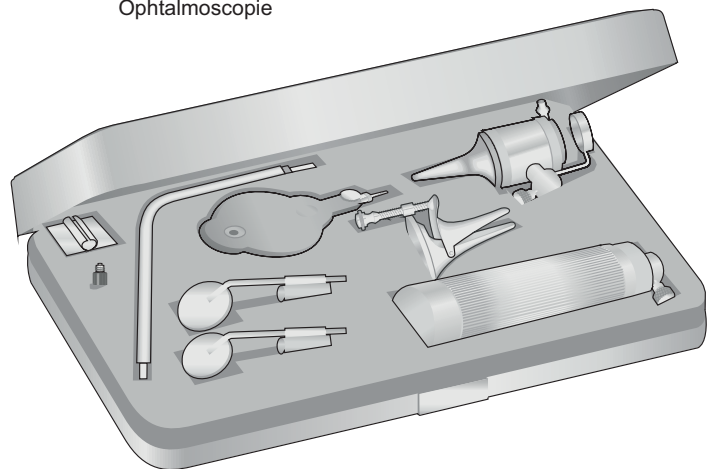
**DUPLAY**  
**AB-41R**

Speculum nasale  
 Nasal specula  
 Nasenspekulum  
 Spéculum nasal



**AB-38**

Lampadina per otoscopio  
 Lamp  
 Lampe  
 Lampe

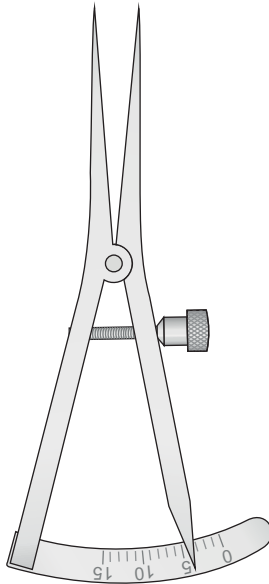


**AB-41**

Set oto-oftalmoscopio-speculum nasale e 2 specchietti laringei  
 Oto-Ophthalmoscope-Nasal specula and 2 Laryngeal mirror  
 Oto-Ophthalmoskop-Nasenspekulum und 2 Kehlkopfspiegel  
 Trousse à Otoscopie-Ophtalmoscopie-spéculum nasal avec 2 miroirs laryngiens

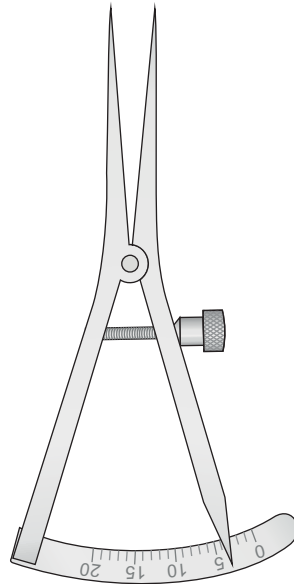


Campo di misura: 0 - 15 mm  
Measuring range: 0 - 15 mm  
Meßbereich: 0 - 15 mm  
Etendue de mesure: 0 - 15 mm  
Alcance de medición: 0 - 15 mm



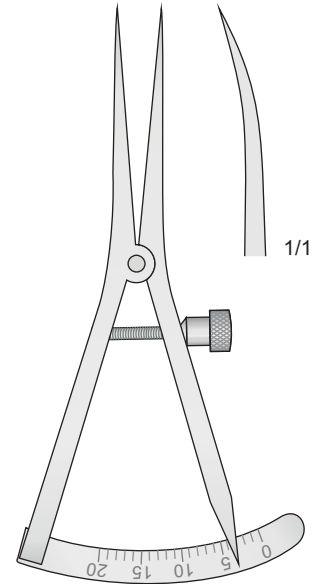
CASTROVIEJO  
**OR-15**  
90 mm

Campo di misura: 0 - 20 mm  
Measuring range: 0 - 20 mm  
Meßbereich: 0 - 20 mm  
Etendue de mesure: 0 - 20 mm  
Alcance de medición: 0 - 20 mm



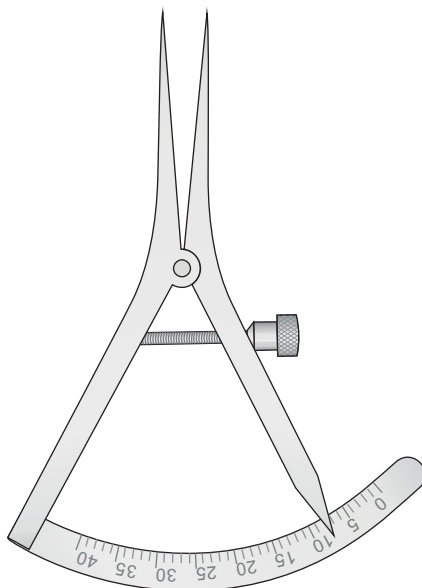
CASTROVIEJO  
**OR-17**  
90 mm

Campo di misura: 0 - 20 mm  
Measuring range: 0 - 20 mm  
Meßbereich: 0 - 20 mm  
Etendue de mesure: 0 - 20 mm  
Alcance de medición: 0 - 20 mm



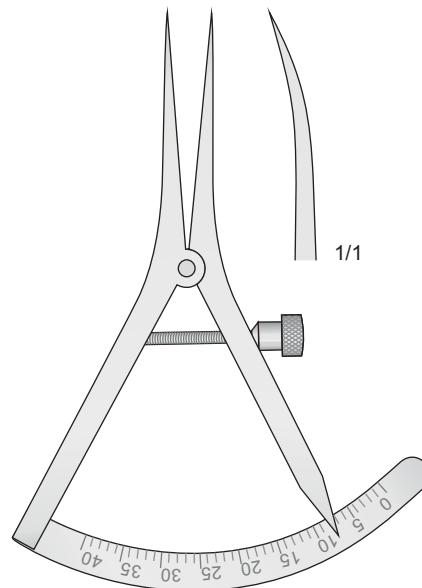
CASTROVIEJO  
**OR-19**  
90 mm

Campo di misura: 0 - 40 mm  
Measuring range: 0 - 40 mm  
Meßbereich: 0 - 40 mm  
Etendue de mesure: 0 - 40 mm  
Alcance de medición: 0 - 40 mm



CASTROVIEJO  
**OR-11**  
90 mm

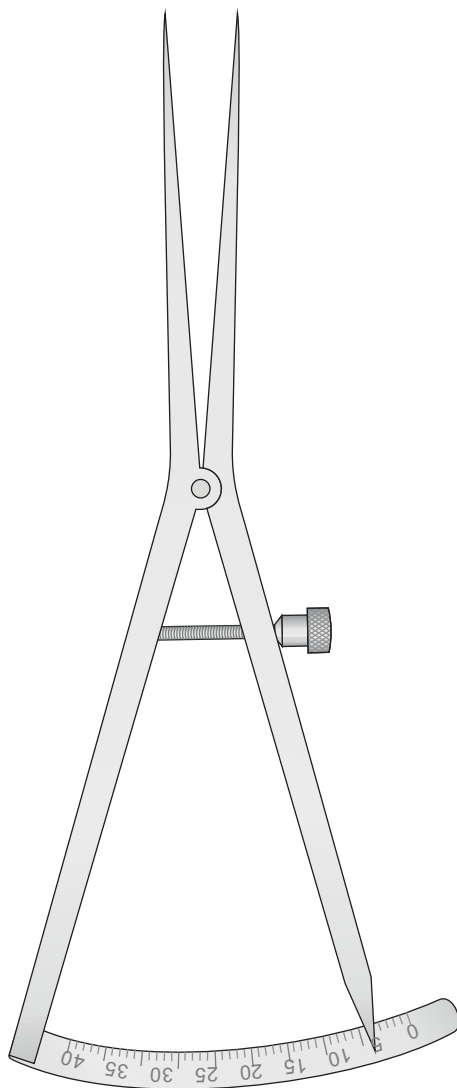
Campo di misura: 0 - 40 mm  
Measuring range: 0 - 40 mm  
Meßbereich: 0 - 40 mm  
Etendue de mesure: 0 - 40 mm  
Alcance de medición: 0 - 40 mm



CASTROVIEJO  
**OR-13**  
90 mm

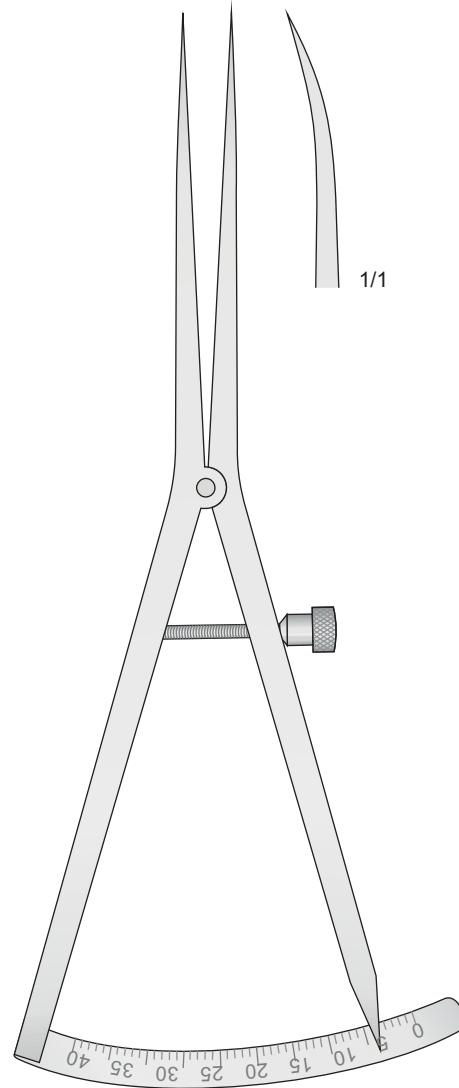


Campo di misura: 0 - 40 mm  
Measuring range: 0 - 40 mm  
Meßbereich: 0 - 40 mm  
Etendue de mesure: 0 - 40 mm  
Alcance de medición: 0 - 40 mm



**CASTROVIEJO**  
**OR-12**  
170 mm

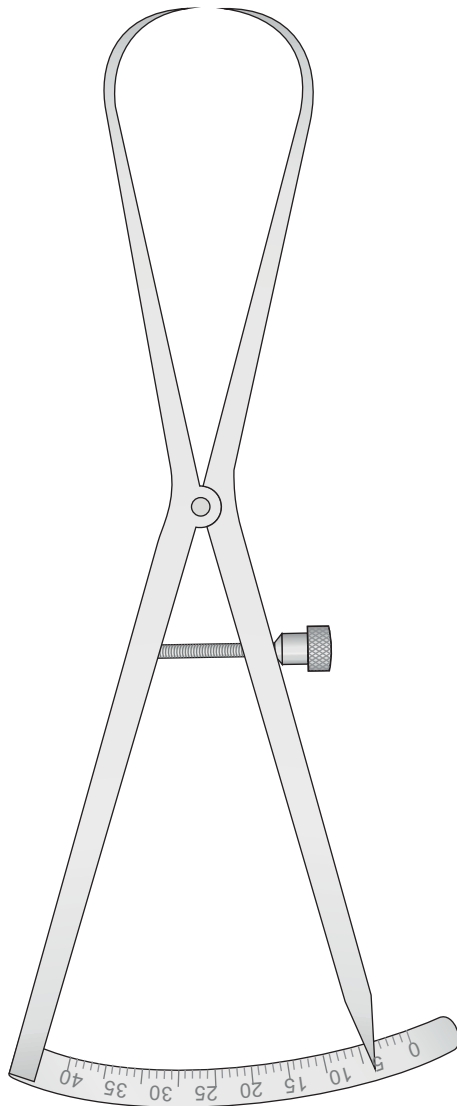
Campo di misura: 0 - 40 mm  
Measuring range: 0 - 40 mm  
Meßbereich: 0 - 40 mm  
Etendue de mesure: 0 - 40 mm  
Alcance de medición: 0 - 40 mm



**CASTROVIEJO**  
**OR-14**  
170 mm

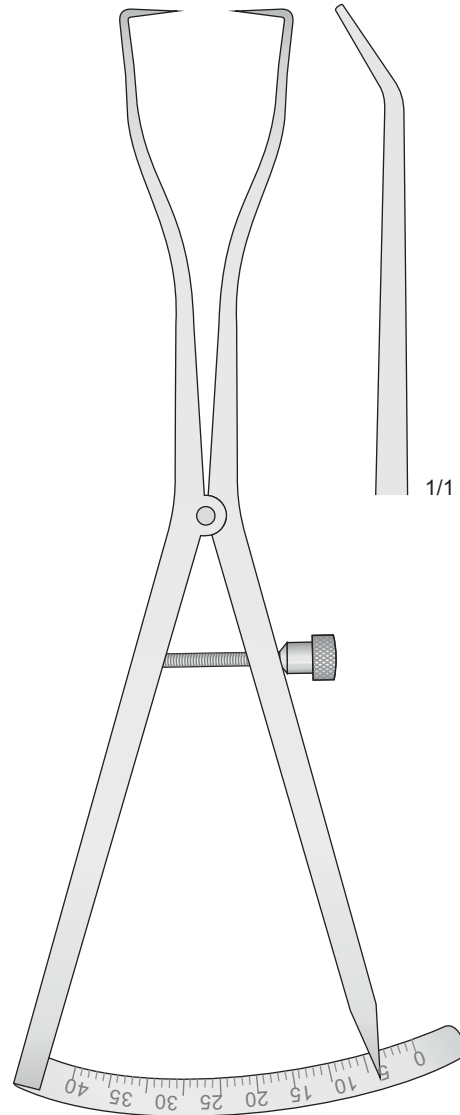


Campo di misura: 0 - 40 mm  
Measuring range: 0 - 40 mm  
Meßbereich: 0 - 40 mm  
Etendue de mesure: 0 - 40 mm  
Alcance de medición: 0 - 40 mm



CASTROVIEJO  
**OR-16**  
170 mm

Campo di misura: 0 - 40 mm  
Measuring range: 0 - 40 mm  
Meßbereich: 0 - 40 mm  
Etendue de mesure: 0 - 40 mm  
Alcance de medición: 0 - 40 mm



CASTROVIEJO  
**OR-18**  
170 mm

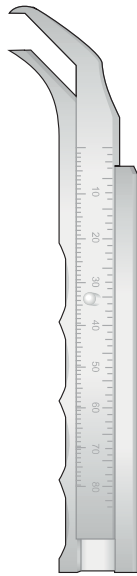


Campo di misura: 0 - 80 mm  
Measuring range: 0 - 80 mm  
Meßbereich: 0 - 80 mm  
Etendue de mesure: 0 - 80 mm  
Alcance de medición: 0 - 80 mm



**OR-40**  
125 mm

Campo di misura: 0 - 80 mm  
Measuring range: 0 - 80 mm  
Meßbereich: 0 - 80 mm  
Etendue de mesure: 0 - 80 mm  
Alcance de medición: 0 - 80 mm



**OR-42**  
120 mm

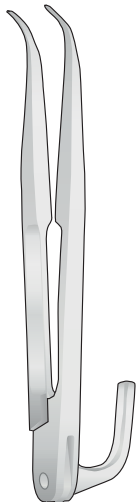
0,5 mm



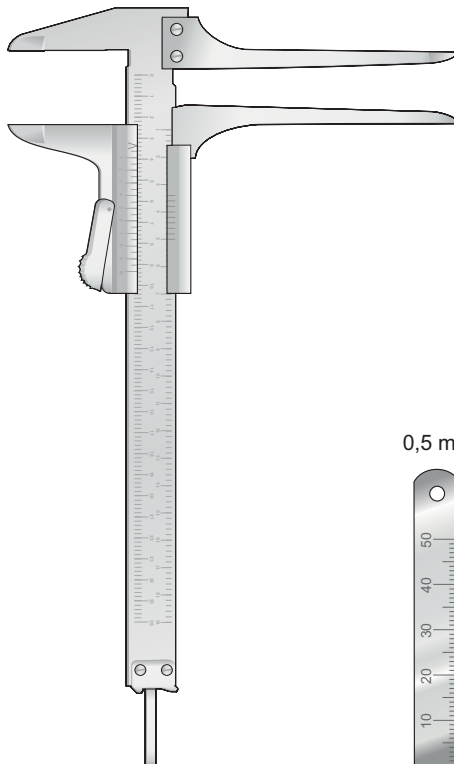
0,5 mm



Campo di misura: 180 mm - Measuring range: 180 mm  
Meßbereich: 180 mm - Etendue de mesure: 180 mm - Alcance de medición: 180 mm



**ZIELINSKY  
DP-725**  
110 mm



**CASPAR  
OR-25**

0,5 mm



**LS-07**  
50 mm

0,5 mm



**LS-08**  
100 mm

0,5 mm



**LS-09**  
150 mm

0,5 mm



**LS-06**  
300 mm

0,5 mm



**LS-05**  
500 mm





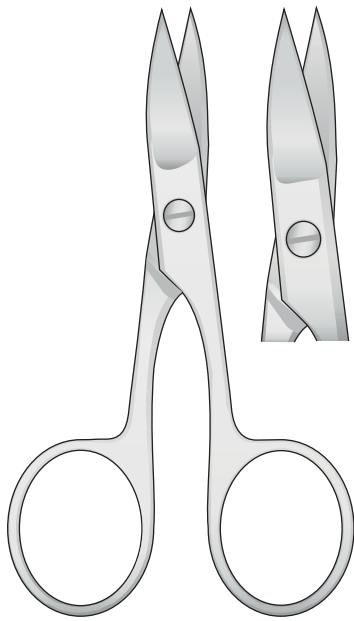
Preparazione  
Forbici per unghie

Preparation  
Nail scissors

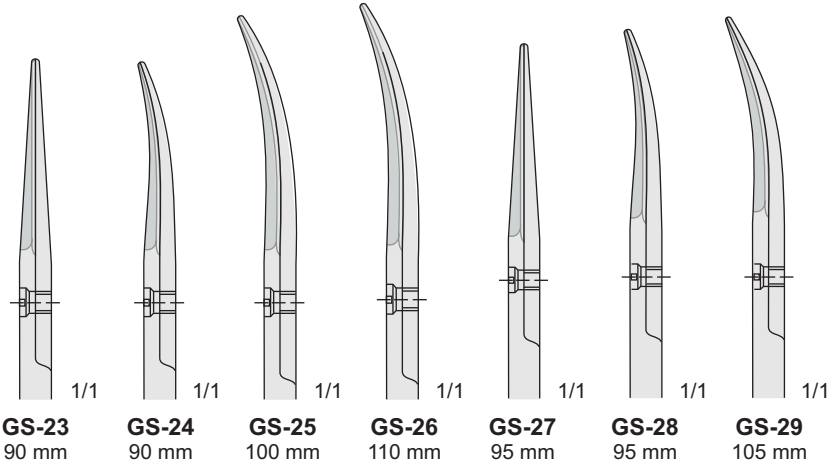
Vorbereitung  
Nagel scheren

Préparation  
Ciseaux à ongles

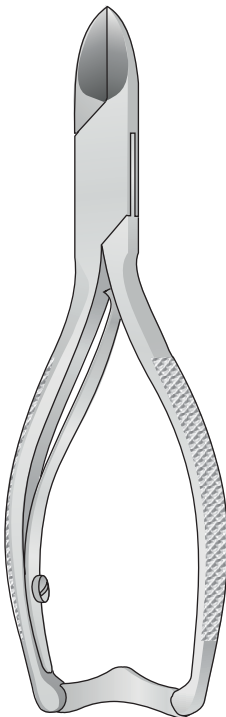
Preparacion  
Tijeras para uñas



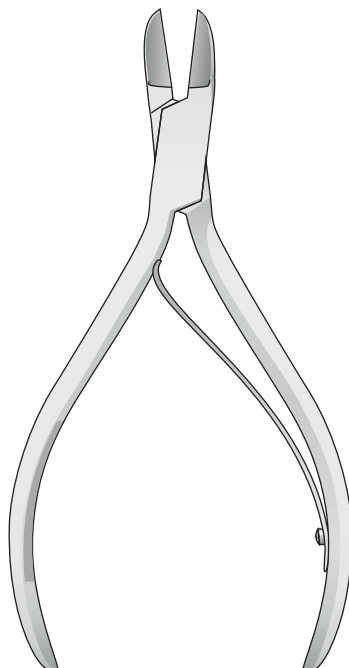
**GS-23/GS-29**



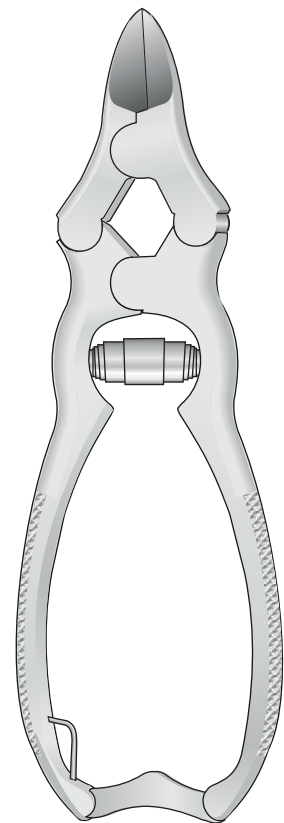
Tronchesi per unghie  
Nail cutters  
Nagelzangen  
Pince à ongles  
Pinzas para uña



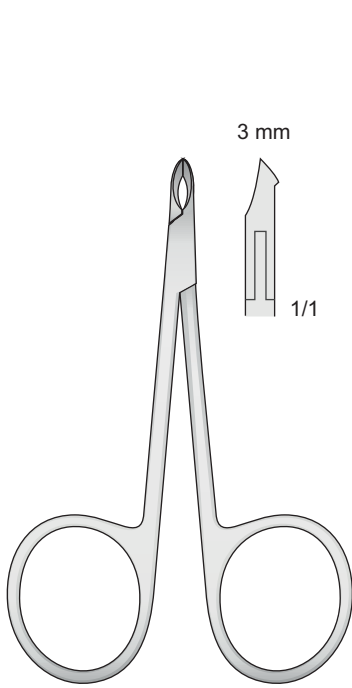
**GS-20**  
135 mm



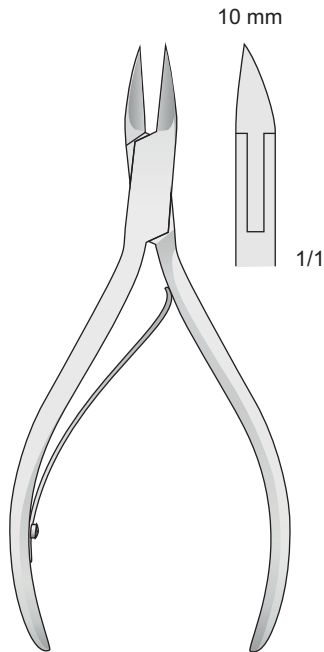
**GS-21**  
120 mm



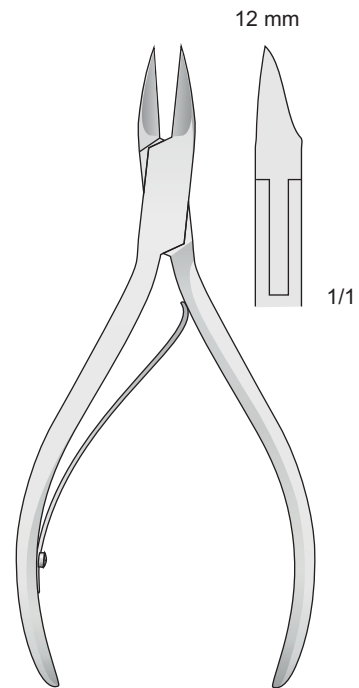
**GS-22**  
155 mm



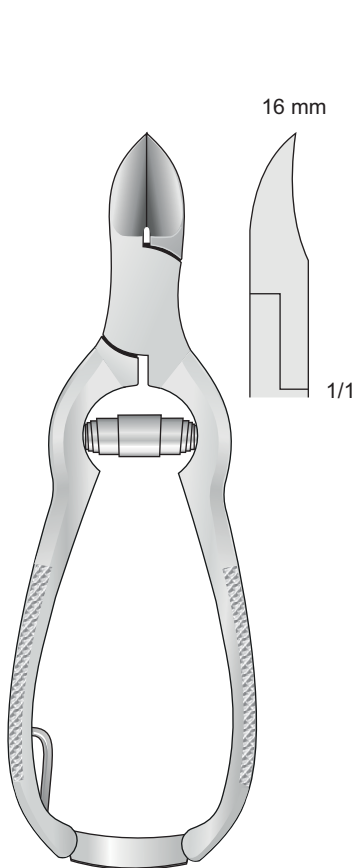
**GS-40**  
85 mm



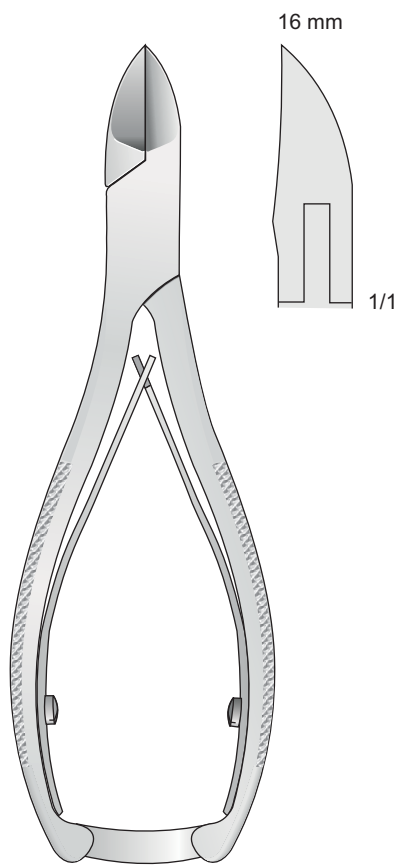
**GS-42**  
100 mm



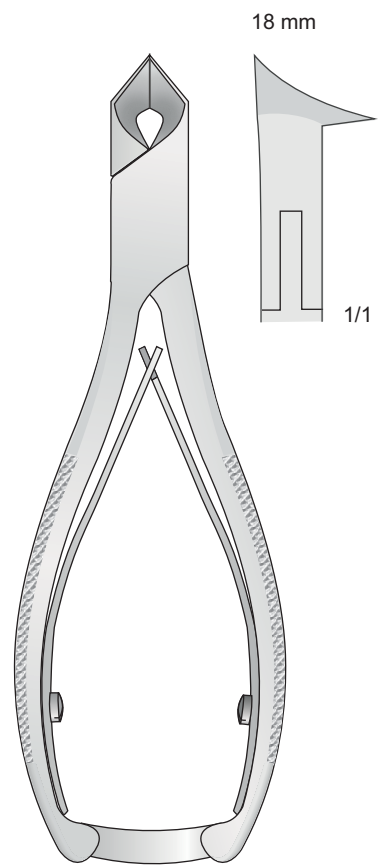
**GS-44**  
110 mm



**GS-46**  
120 mm



**GS-48**  
140 mm



**GS-50**  
135 mm



2

Bisturi e lame  
Knives and Scalpel blades  
Skalpellslingen  
Lames de bistouris  
Hojas de bisturias





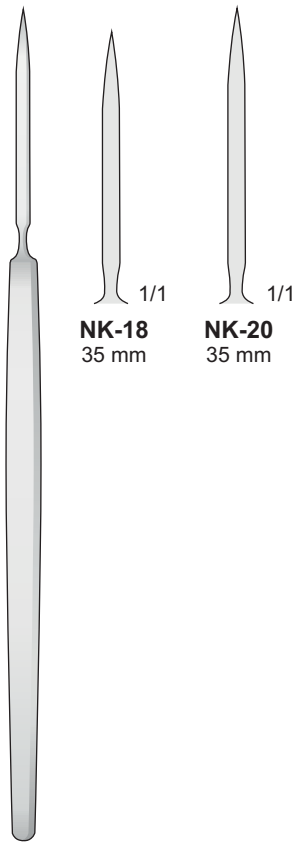
Bisturi

Knives

Skalpelle

Bistouris

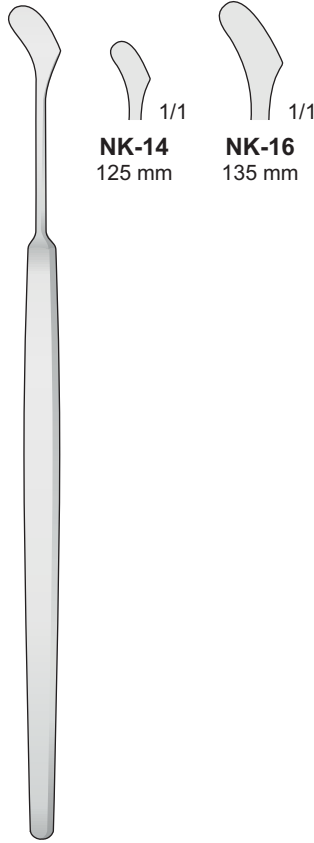
Bisturies



**NK-18**  
35 mm

**NK-20**  
35 mm

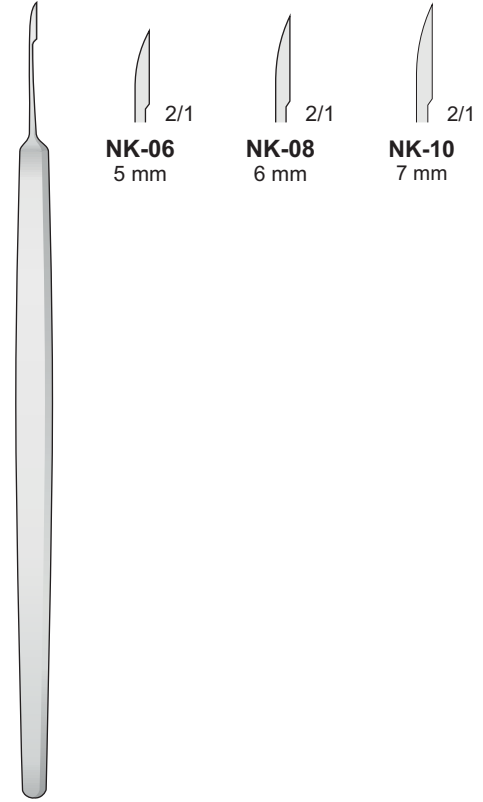
GRAEFE  
**NK-18/NK-20**  
140 mm



**NK-14**  
125 mm

**NK-16**  
135 mm

GRAEFE  
**NK-14/NK-16**

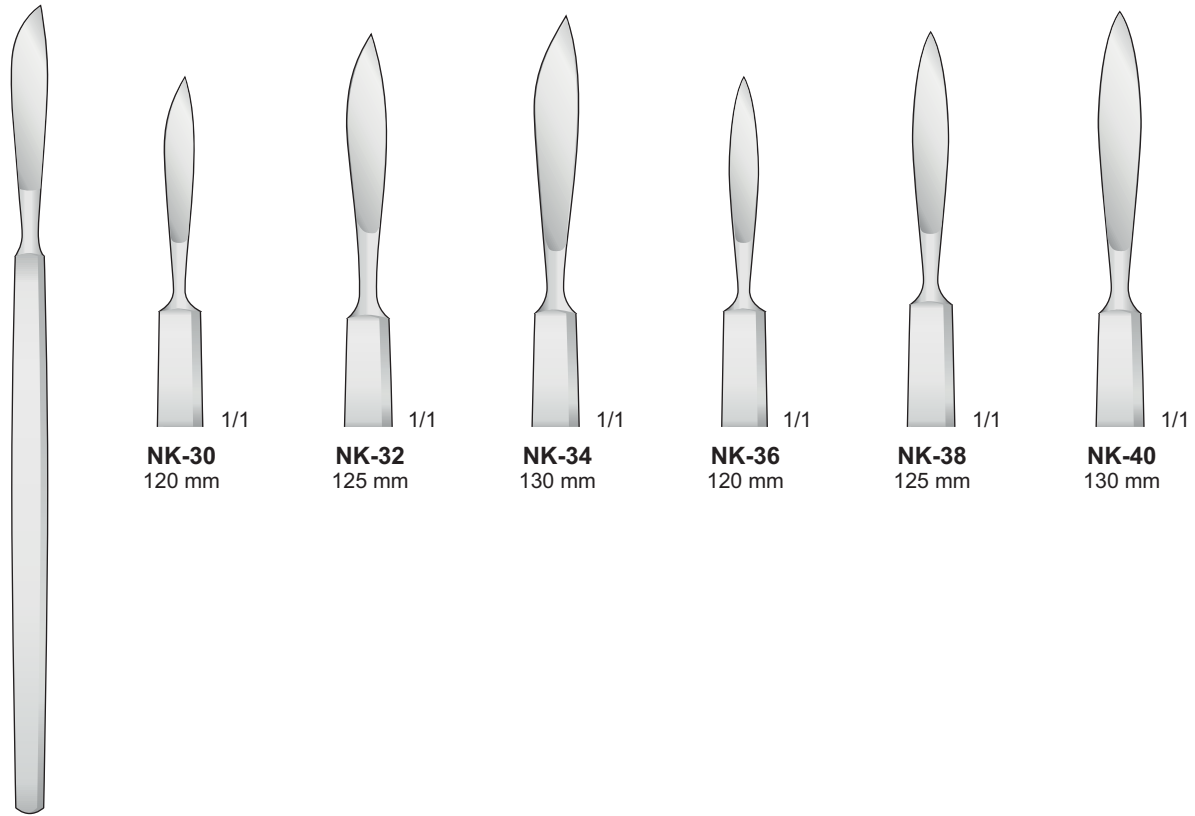


**NK-06**  
5 mm

**NK-08**  
6 mm

**NK-10**  
7 mm

ZIEGLER  
**NK-06/NK-10**  
115 mm



**NK-30**  
120 mm

**NK-32**  
125 mm

**NK-34**  
130 mm

**NK-36**  
120 mm

**NK-38**  
125 mm

**NK-40**  
130 mm

**NK-30/NK-40**



Punche da biopsia - Dermal punches  
Haut-Trephinen - Tréphines cutanées  
Trépanos cutâneos

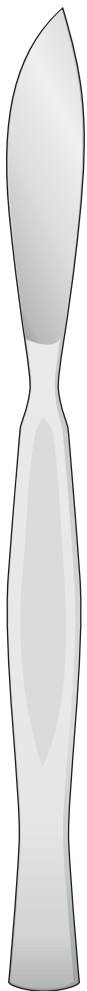


- 3 mm
- FL-150
- 4 mm
- FL-151
- 5 mm
- FL-152
- 6 mm
- FL-153

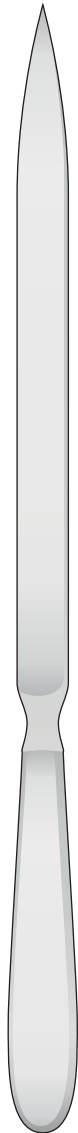
KEYES  
FL-150/FL-153  
100 mm

DESMARRES  
NK-95  
135 mm

DESMARRES  
NK-96  
135 mm



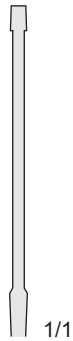
NK-90  
180 mm



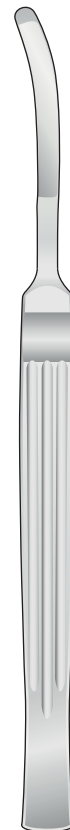
NK-91  
280 mm



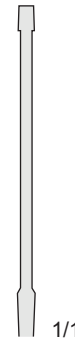
JOSEPH  
NK-100  
150 mm



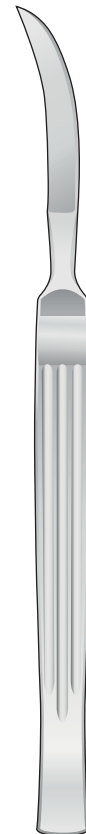
1/1



CONVERSE  
NK-101  
160 mm



1/1



NK-102  
160 mm



**NK-31/NK-57**



1/1

**NK-50**  
150 mm



1/1

**NK-51**  
155 mm



1/1

**NK-31**  
158 mm



1/1

**NK-52**  
160 mm



1/1

**NK-53**  
170 mm



1/1

**NK-35**  
175 mm



1/1

**NK-54**  
150 mm



1/1

**NK-55**  
155 mm



1/1

**NK-33**  
158 mm



1/1

**NK-56**  
160 mm



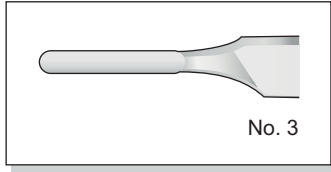
1/1

**NK-57**  
170 mm



1/1

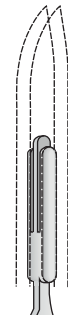
**NK-37**  
175 mm



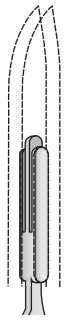
No. 3

1,5 mm

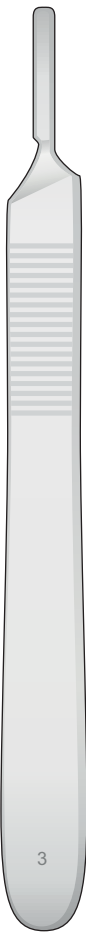
2,5 mm



MA-B8



MA-B9



MA-B3  
Fig. 3



MA-B3M  
Fig. 3M



MA-B7  
Fig. 7



MA-B7K  
Fig. 7k



MA-B1  
Fig. 5

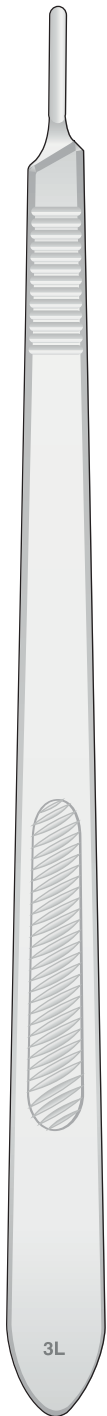
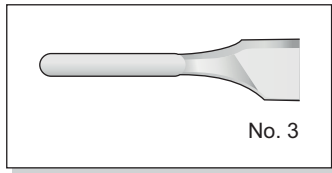


MA-B2  
Fig. 5a

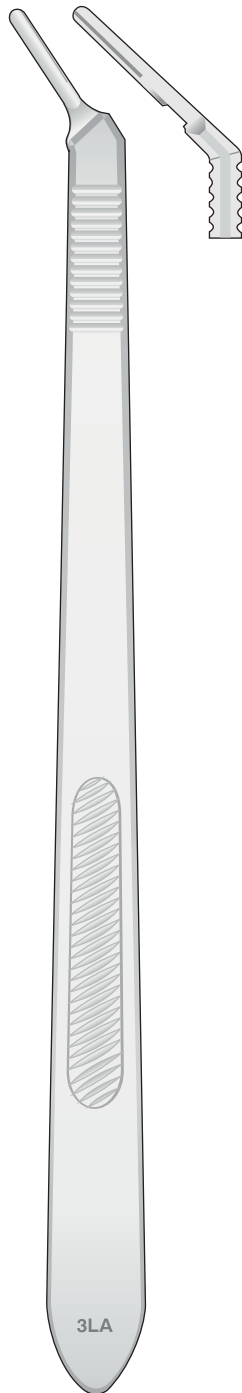


MA-B8/MA-B9  
155 mm





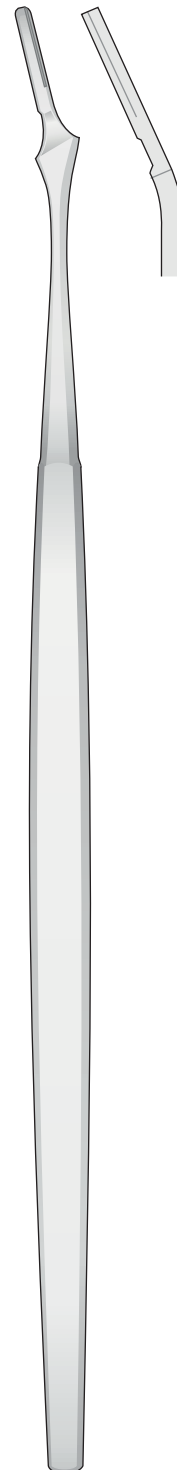
**MA-B3L**  
Fig. 3L



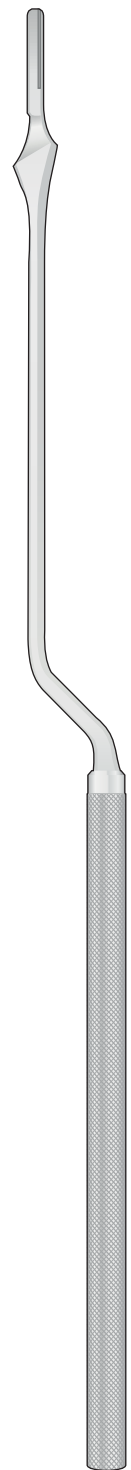
**MA-B5**  
Fig. 3LA



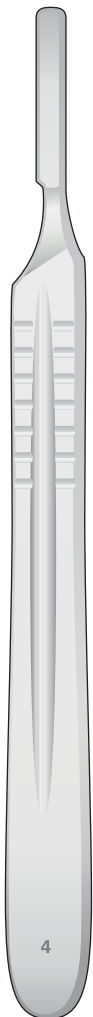
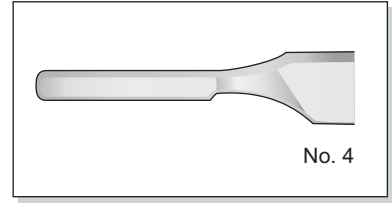
**MA-B11**  
210 mm



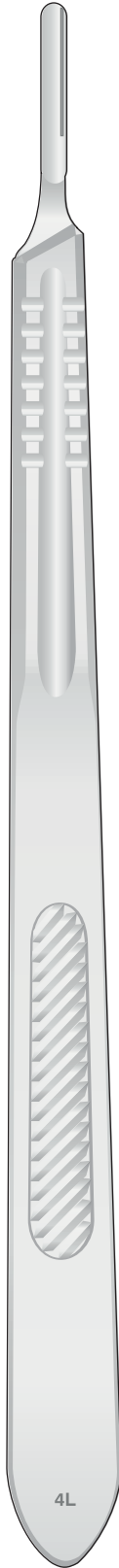
**MA-B12**  
210 mm



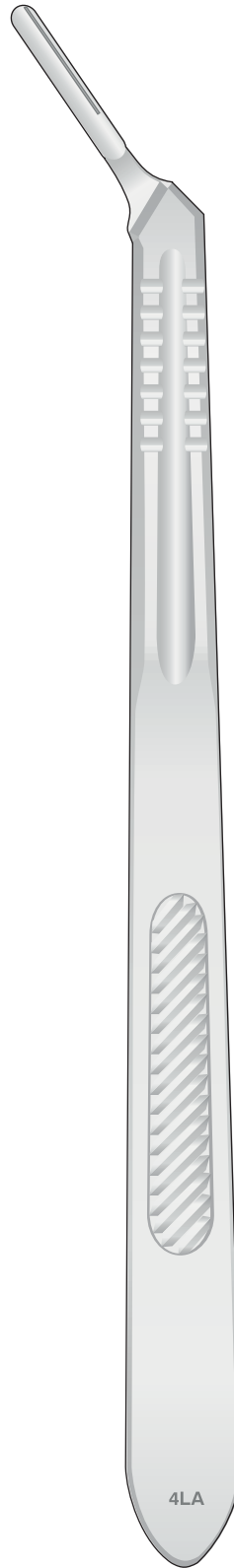
**MA-B15**  
210 mm



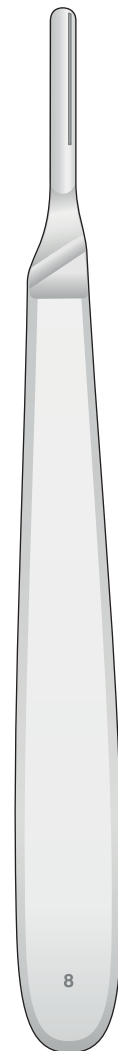
**MA-B4**  
Fig. 4



**MA-B4L**  
Fig. 4L



**MA-B6**  
Fig. 4LA

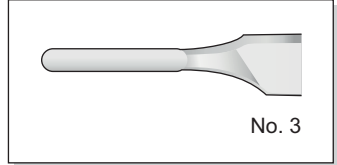


**MA-B10**  
Fig. 8



Scatole da 100 pezzi  
Packungen à 100  
Packages of 100 ea  
Boîtes de 100 pièces  
Cajas de 100 c/u

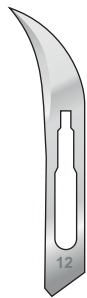
Doppio taglio  
Double cutting  
Doppelschneidig  
Deux tranchants  
Doble corta



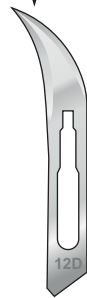
**LB-10**  
Fig. 10



**LB-11**  
Fig. 11



**LB-12**  
Fig. 12



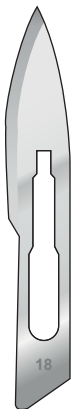
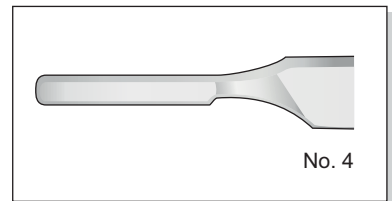
**LB-12D**  
Fig. 12D



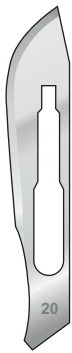
**LB-13**  
Fig. 13



**LB-15**  
Fig. 15



**LB-18**  
Fig. 18



**LB-20**  
Fig. 20



**LB-21**  
Fig. 21



**LB-22**  
Fig. 22



**LB-23**  
Fig. 23



**LB-24**  
Fig. 24



**LB-25**  
Fig. 25



**LB-36**  
Fig. 36



**LB-361**  
Conf. 10 pz.



**LB-362**  
Conf. 10 pz.



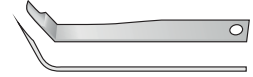
**LB-363**  
Conf. 1 pz.



**LB-364**  
Conf. 10 pz.



**LB-365**  
Conf. 10 pz.



**LB-366**  
Conf. 1 pz.



**LB-367**  
Conf. 10 pz.



**LB-368**  
Conf. 10 pz.



**LB-369**  
Conf. 1 pz.



**NK-1**  
100 mm



**NK-2**  
150 mm



**BB-46**  
135 mm



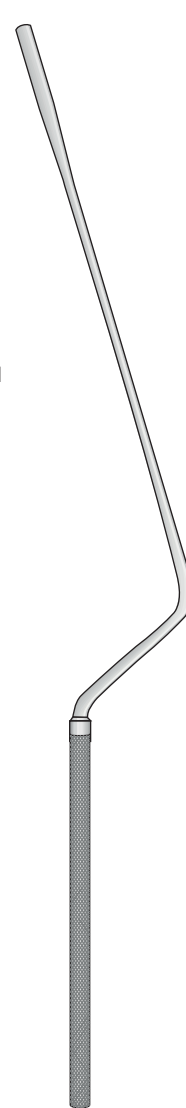
**BB-48** - 155 mm  
**BB-50** - 180 mm  
**BB-52** - 200 mm



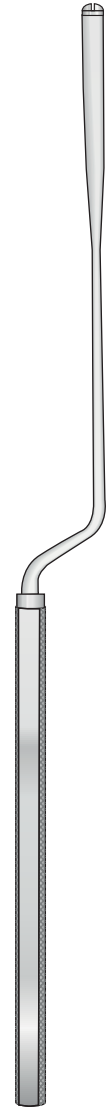
CASPAR  
**BB-50**



**BB-52**



LANDOLT  
**BB-38**  
210 mm



LANDOLT  
**BB-40**  
250 mm



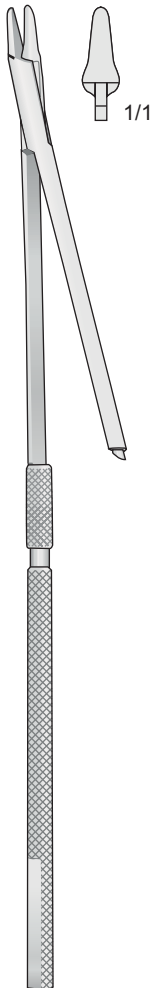
Pinze togli lame  
per bisturi

Scalpel blade  
removing forceps

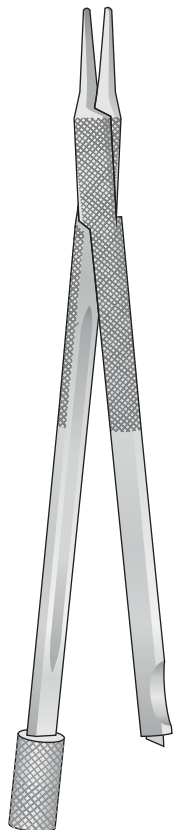
Klingenbrecher  
Rasierklingen

Pinces pour enlever  
les lames de bistouris

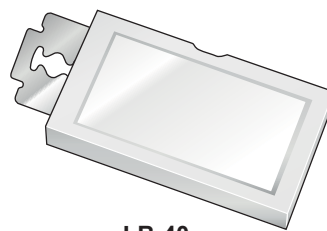
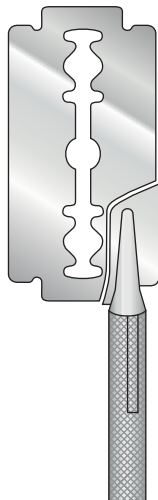
Pinza para quitar  
hojas de bisturias



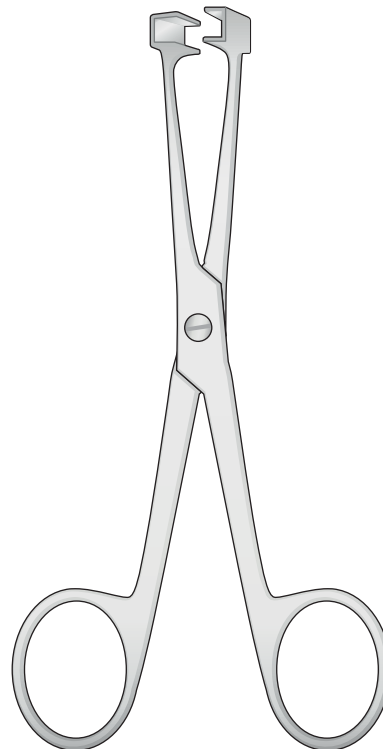
**NK-85**  
180 mm



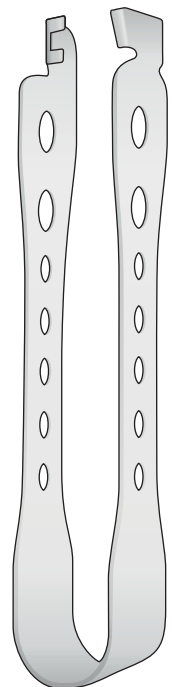
**NK-12**  
120 mm



**LB-40**  
Scatola da 10 lame  
Package 10 blades  
Packung 10 Klingen  
Boite de 10 lames  
Cajita de 10 hojas

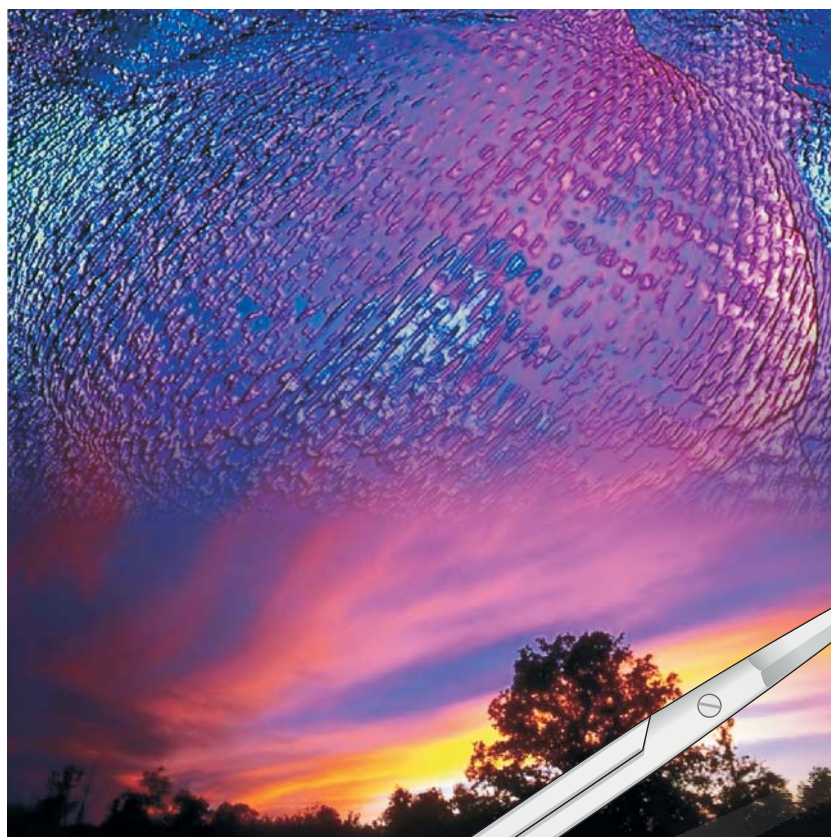


**GS-18**  
135 mm



**GS-16**  
115 mm





3

Forbici  
Scissors  
Scheren  
Ciseaux  
Tijeras







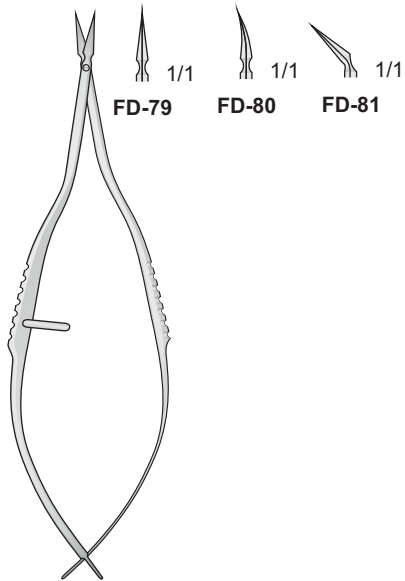
Micro forbici

Micro scissors

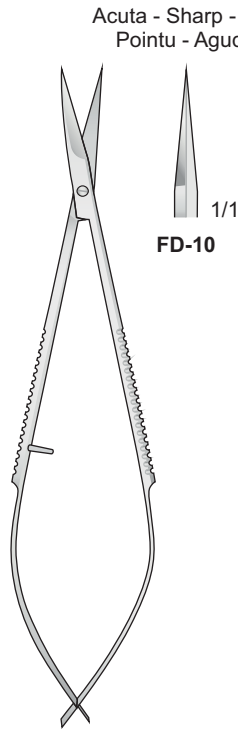
Micro Scheren

Micro ciseaux

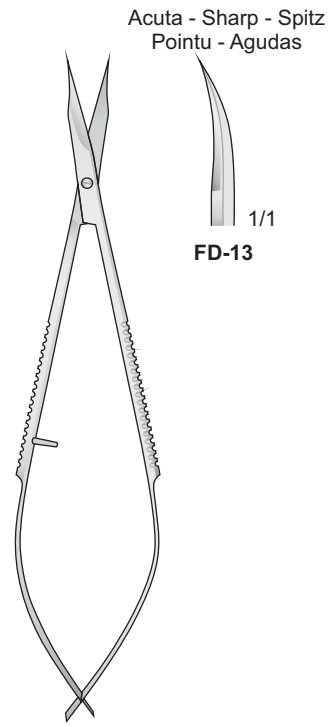
Micro tijeras



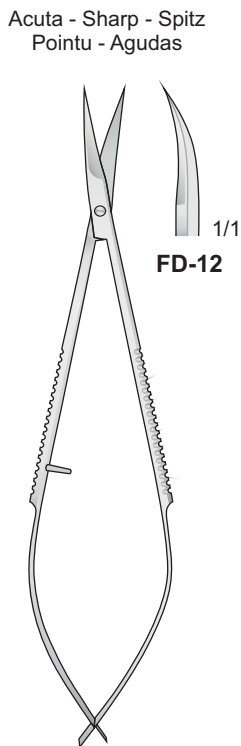
VANNAS  
FD-79/FD-81  
85 mm



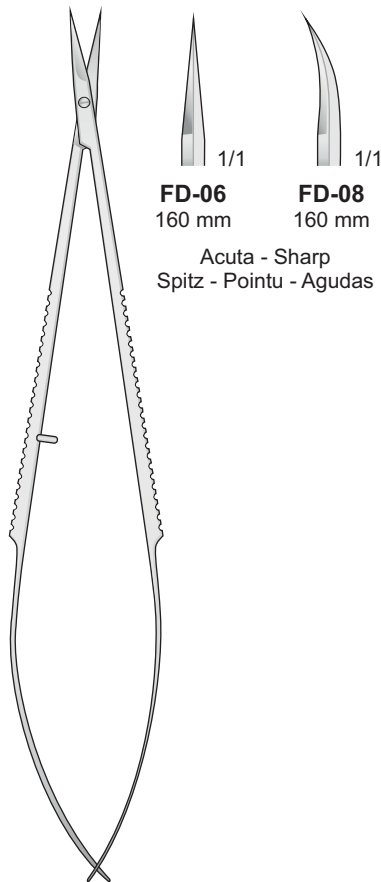
NOYES  
FD-10  
120 mm



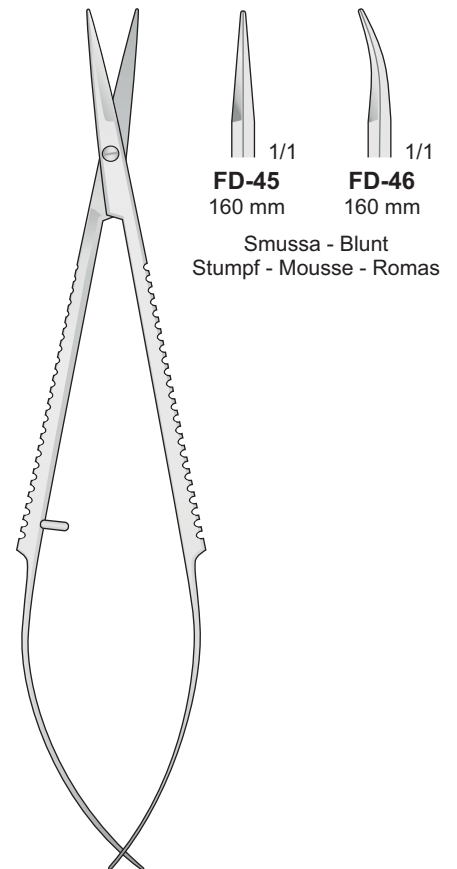
WESTCOTT  
FD-13  
120 mm



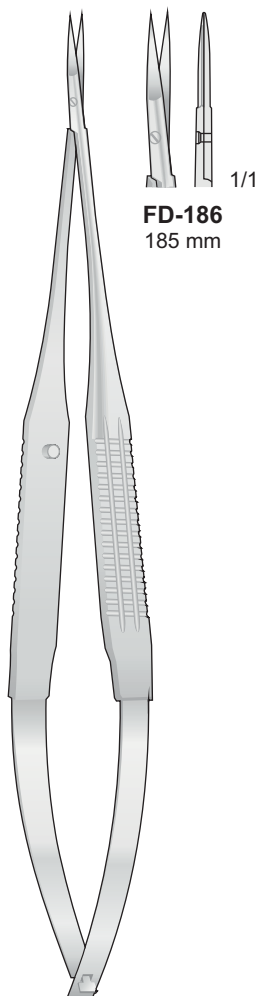
NOYES  
FD-12  
120 mm



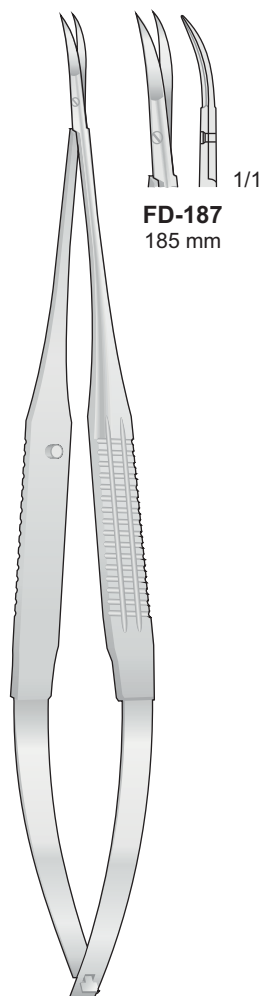
FD-06/FD-08  
160 mm



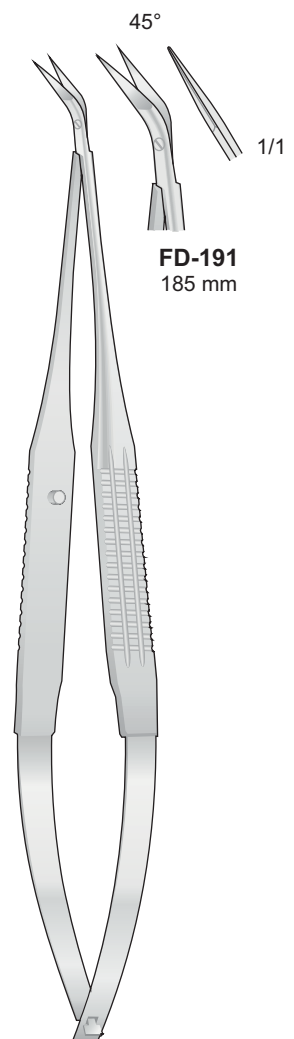
FD-45/FD-46  
160 mm



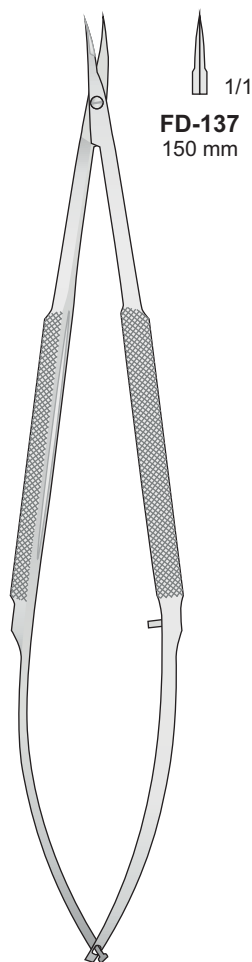
YASARGIL  
**FD-186**  
185 mm



JACOBSON  
**FD-187**  
185 mm



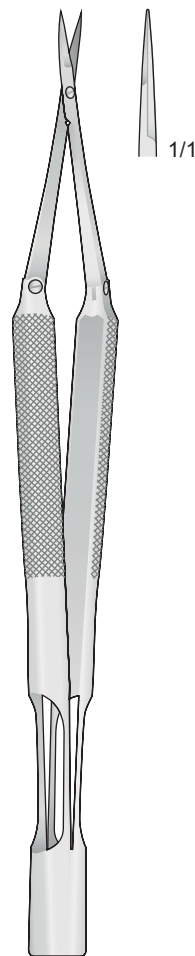
POTTS-YASARGIL  
**FD-191**  
185 mm



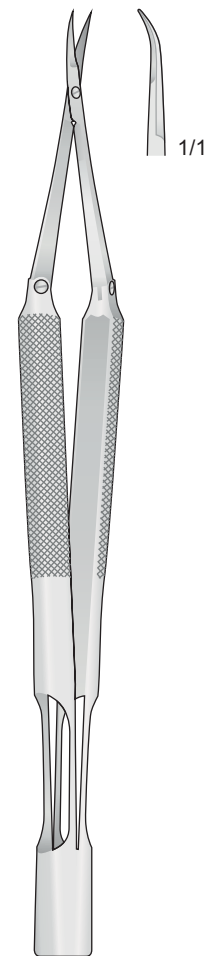
**FD-137**  
150 mm

**FD-138**  
150 mm

**FD-137/FD-138**  
150 mm



**BROCK**  
**FD-221**  
150 mm



**BROCK**  
**FD-223**  
150 mm



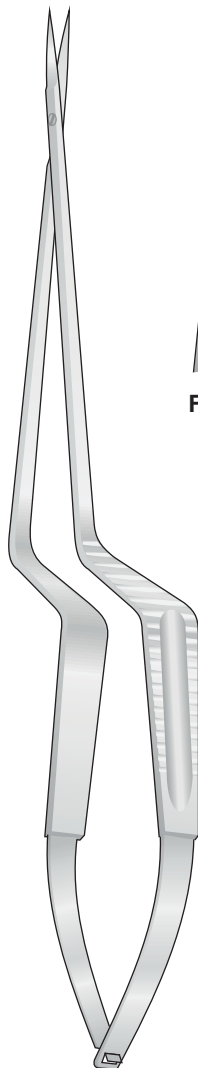
Micro forbici  
a baionetta

Micro scissor  
bayonet-shared

Micro-Federscheren  
Bayonettförmig

Micro ciseaux  
baionette

Micro tijeras  
Bajonet



FD-306/FD-311  
190 mm



FD-306



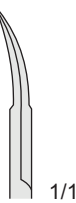
FD-307



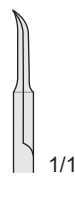
FD-310



FD-311



1/1



1/1



Micro forbici  
a baionetta

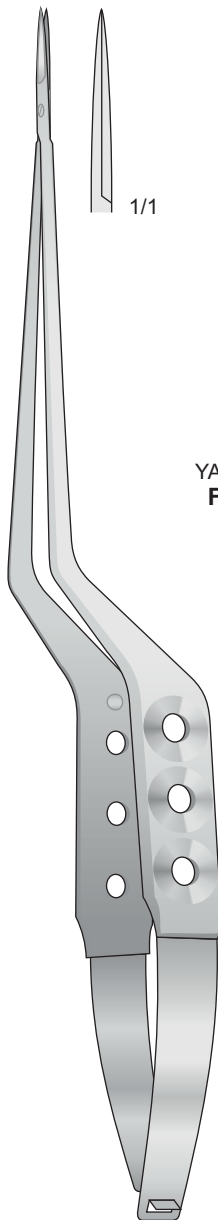
Micro scissor  
bayonet-shared

Micro-Federscheren  
Bayonettförmig

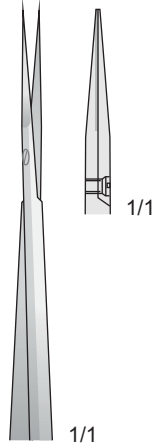
Micro ciseaux  
baionette

Micro tijeras  
Bajonet

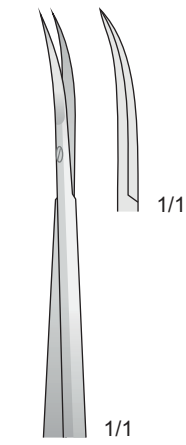
Dentellata  
Sawedge  
Gezahnt  
Dentelés  
Dentadas



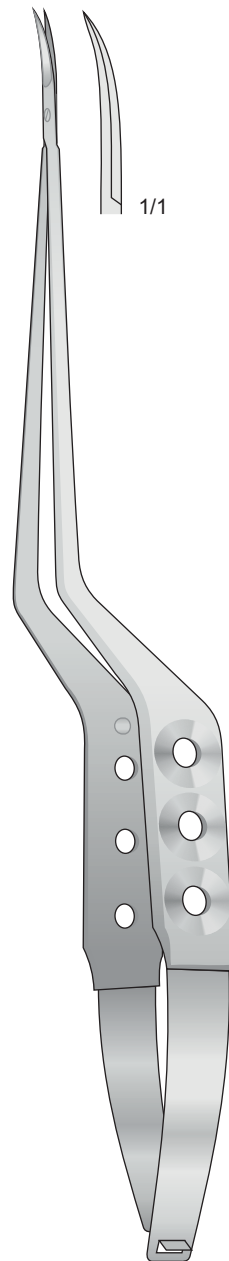
YASARGIL  
**FD-408**  
225 mm



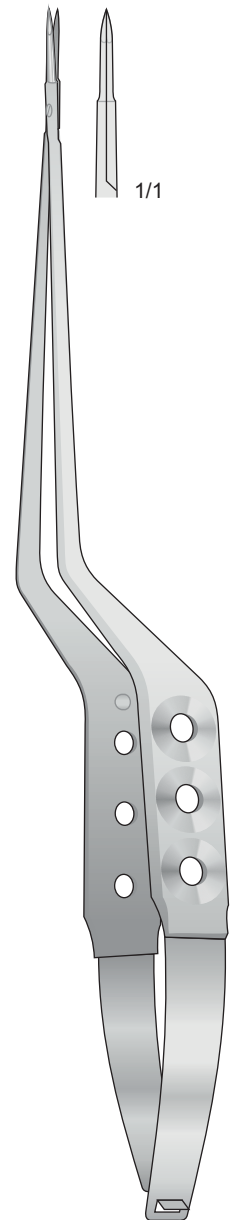
YASARGIL  
**FD-409**



YASARGIL  
**FD-411**



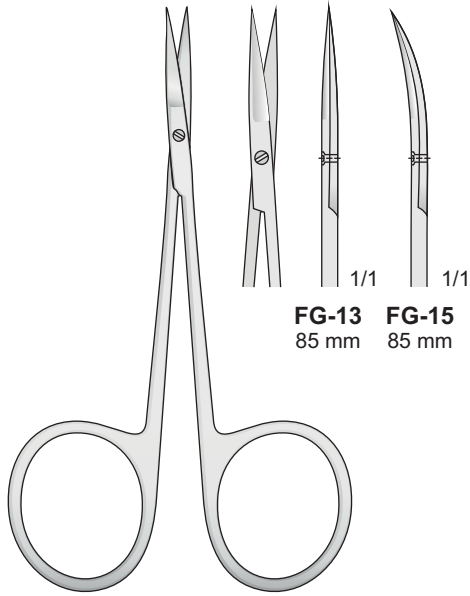
YASARGIL  
**FD-412**  
245 mm



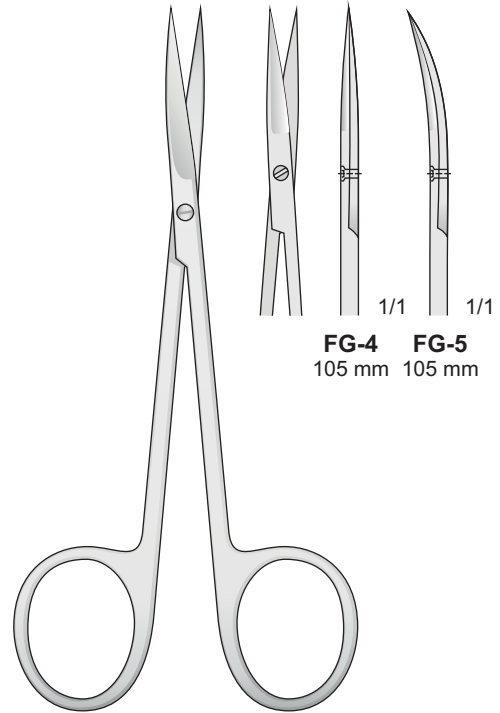
VANNAS  
**FD-410**  
225 mm



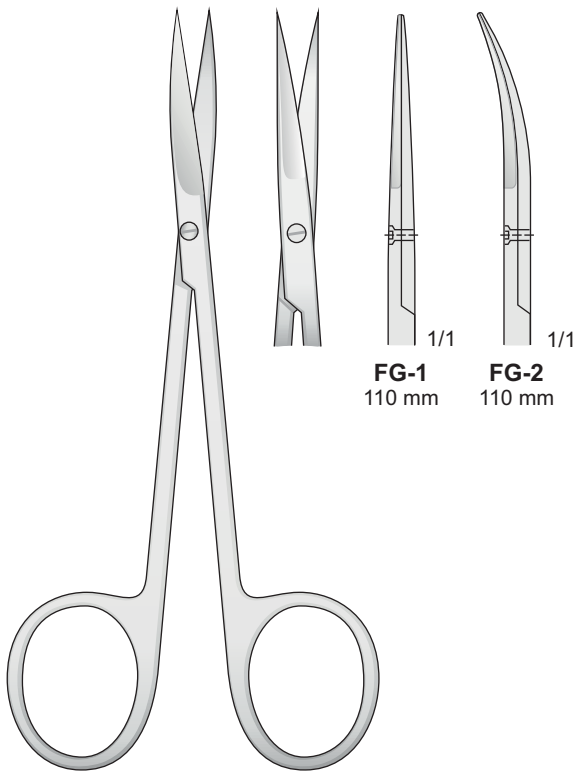
Acute  
Pointed  
Spitz  
Pointus  
Agudas



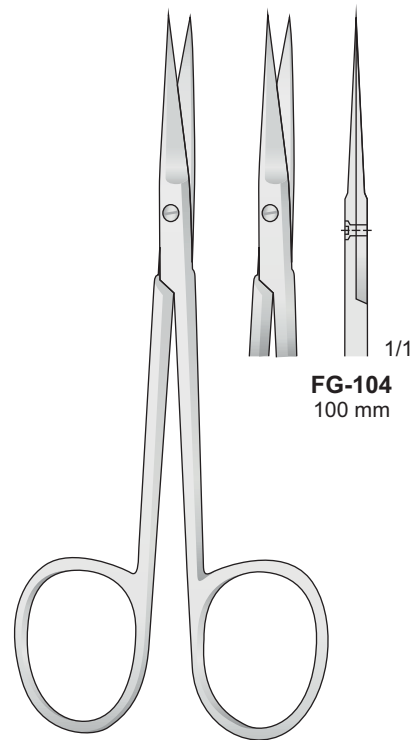
MICRO-IRIS  
FG-13/FG-15  
85 mm



FG-4/FG-5  
105 mm



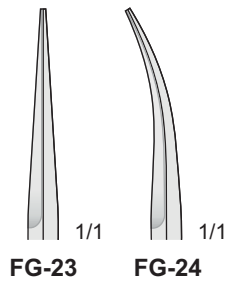
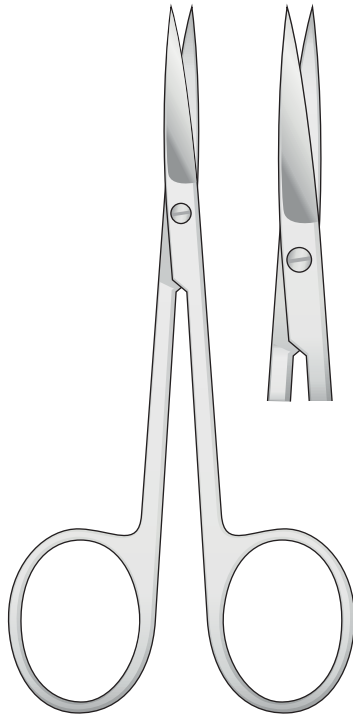
IRIS  
FG-1/FG-2  
110 mm



FG-104  
100 mm



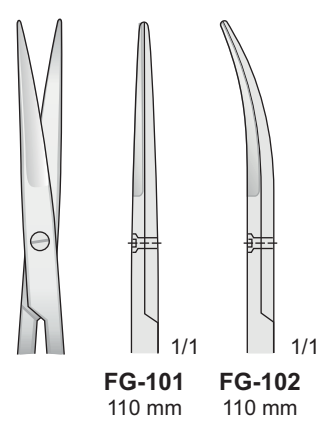
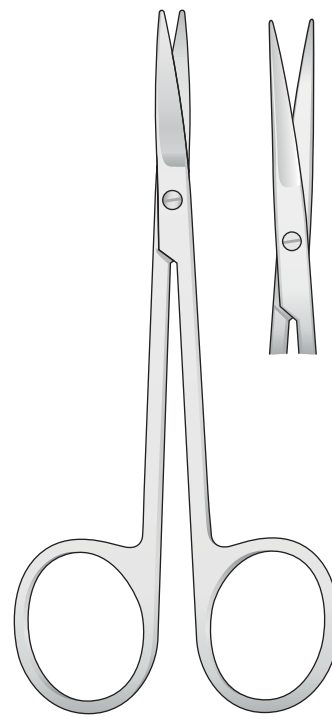
Smussa - Blunt  
Stumpf - Émoussé - Romo



FG-23

FG-24

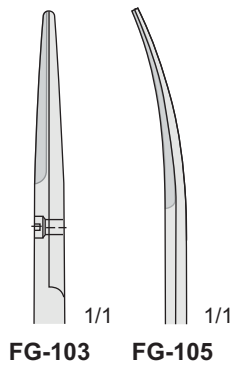
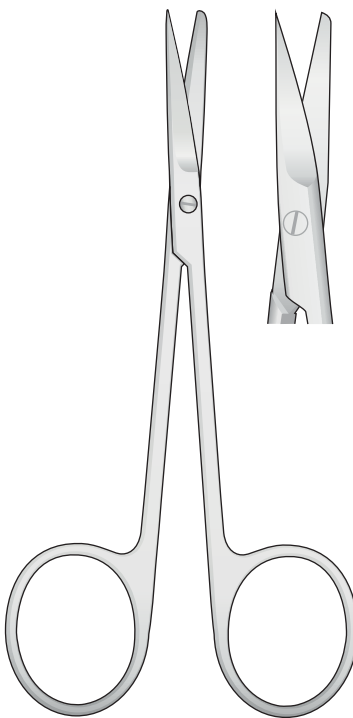
FG-23/FG-24  
110 mm



FG-101  
110 mm

FG-102  
110 mm

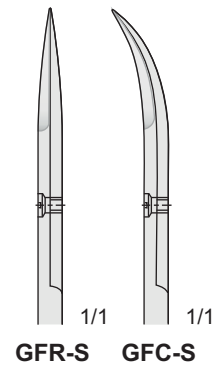
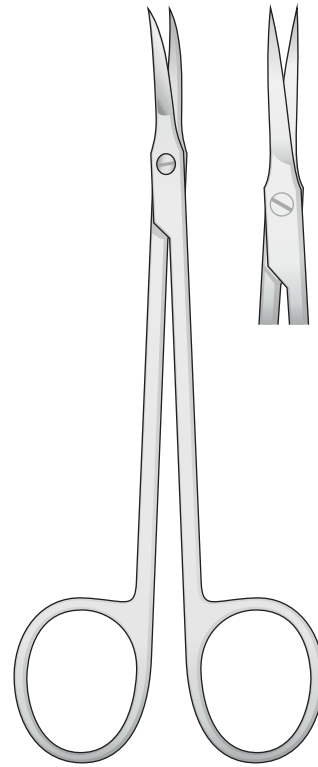
FG-101/FG-102  
110 mm



FG-103

FG-105

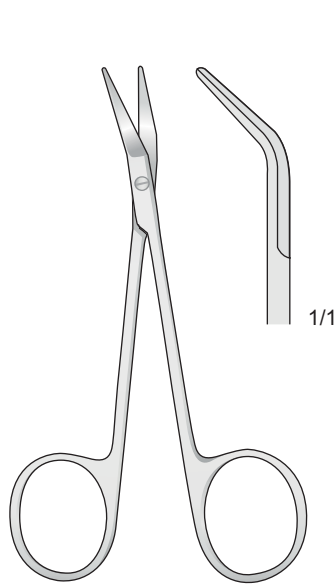
FG-103/FG-105  
110 mm



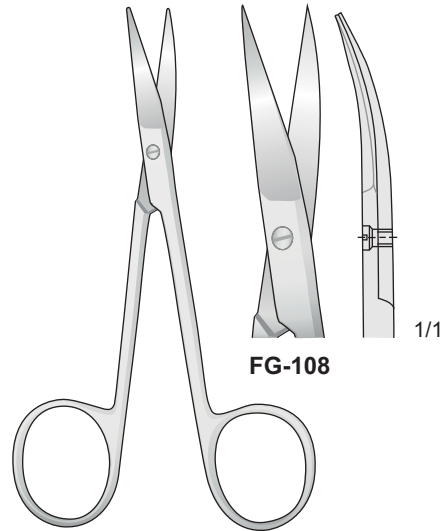
GFR-S

GFC-S

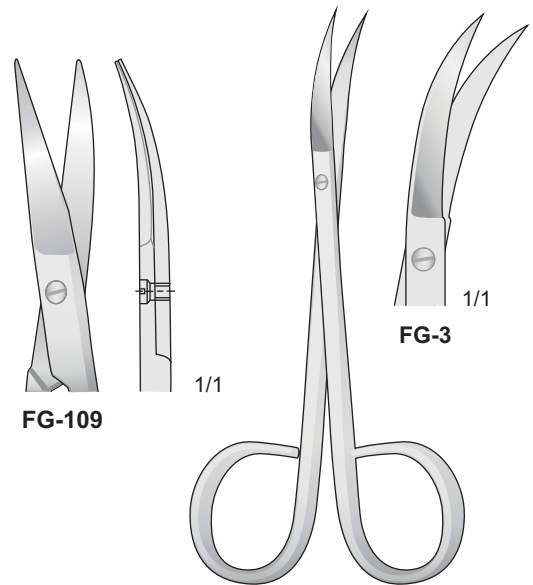
GFR-S/GFC-S  
120 mm



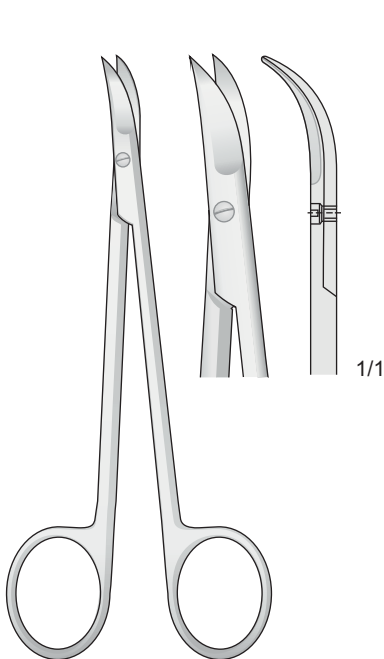
GRAEFE  
**FG-30**  
100 mm



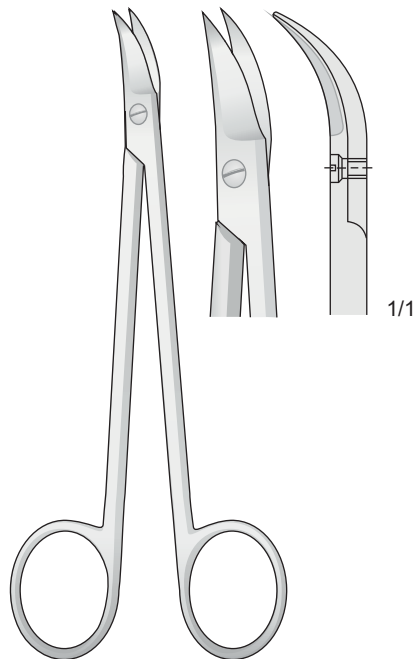
COTTLE-MASING  
**FG-108/FG-109**  
105 mm



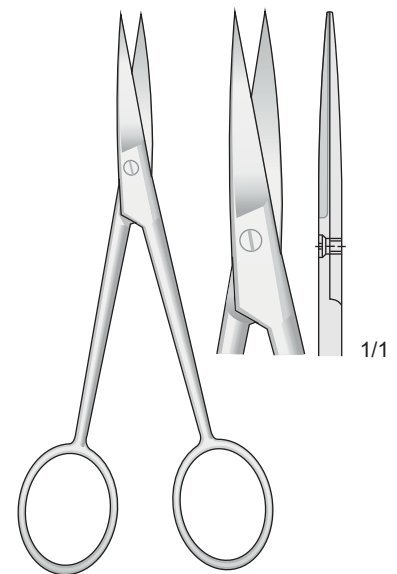
**FG-3**  
115 mm



CHADWICK  
**FG-39**  
115 mm

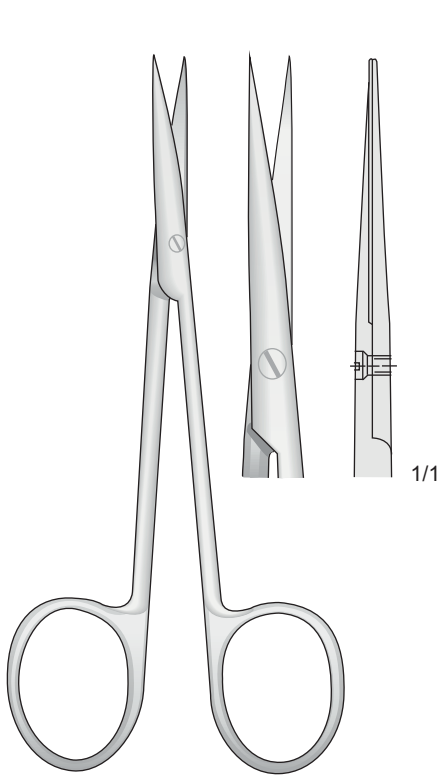


QUINBY  
**FG-38**  
130 mm

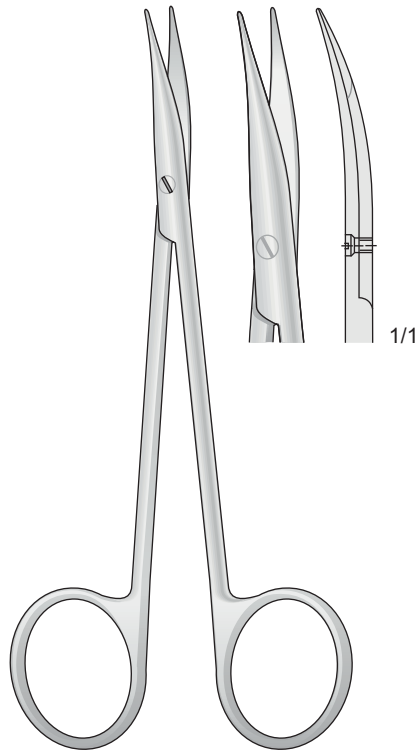


**FG-119**  
110 mm

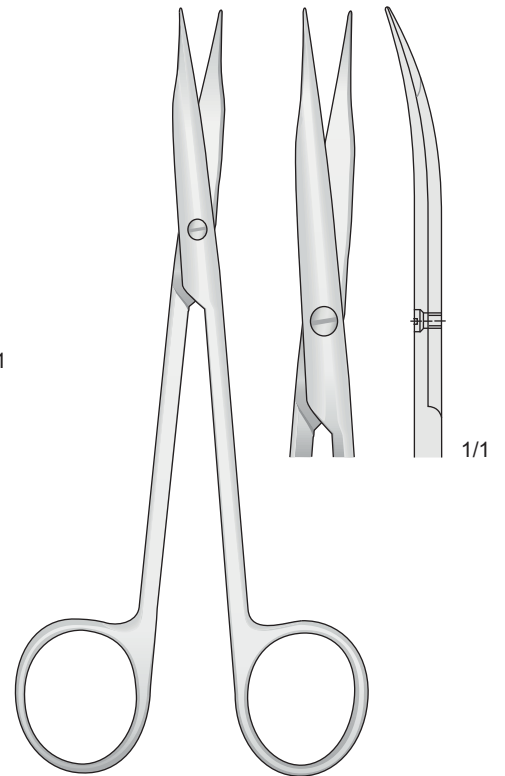




KILNER  
FG-58  
115 mm

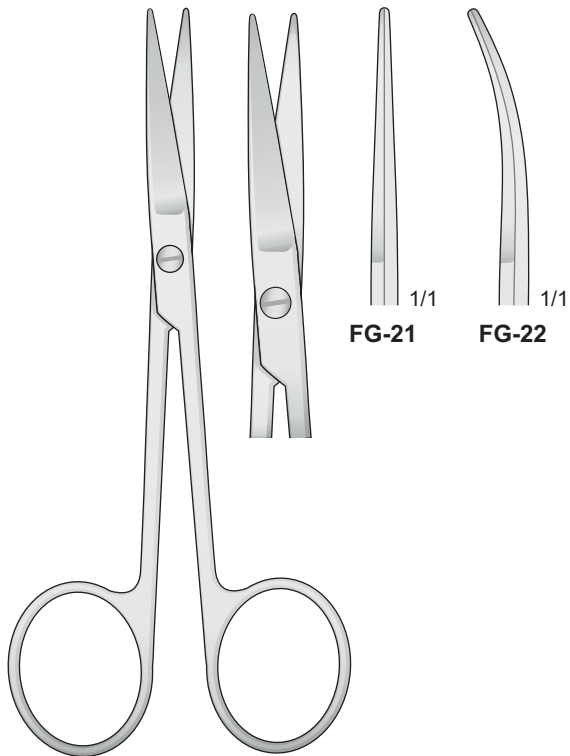


JAMESON-WERBER  
FG-123  
130 mm



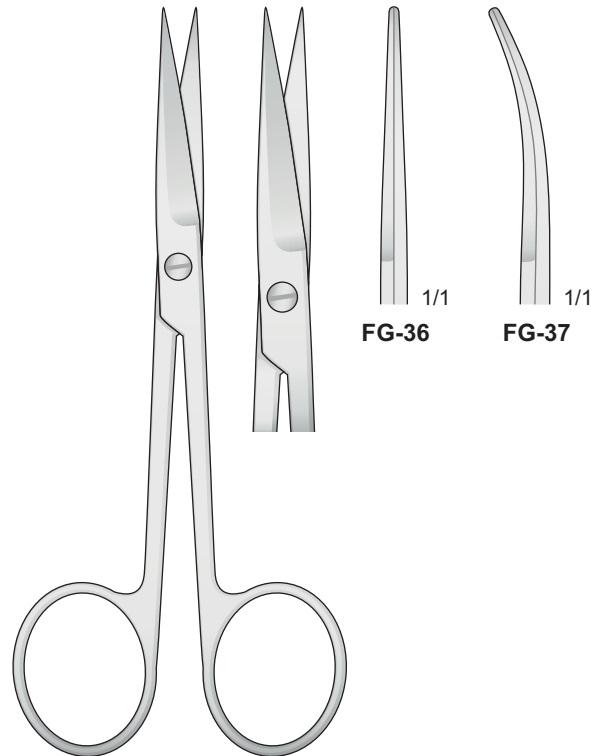
JAMESON  
FG-124  
145 mm

Smussa - Blunt  
Stumpf - Émoussé - Romo

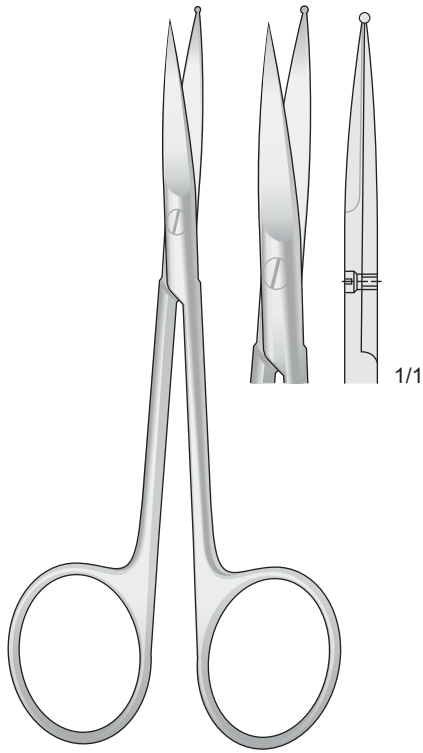


FG-21/FG-22  
115 mm

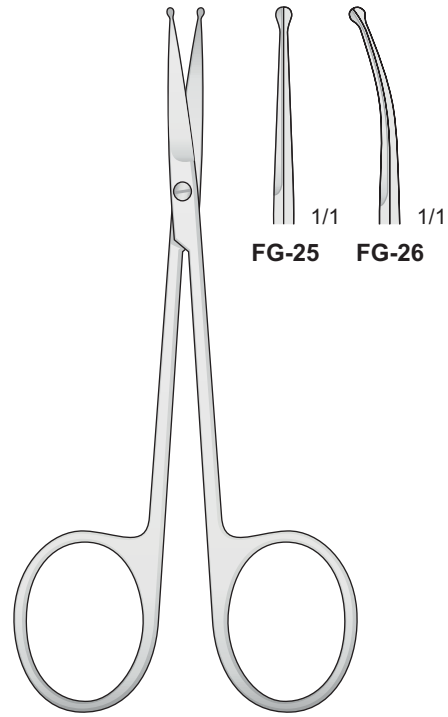
Acuta - Sharp  
Spitz - Aigu - Agudo



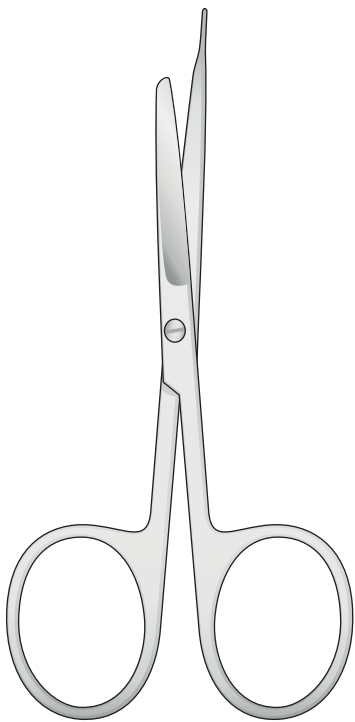
FG-36/FG-37  
115 mm



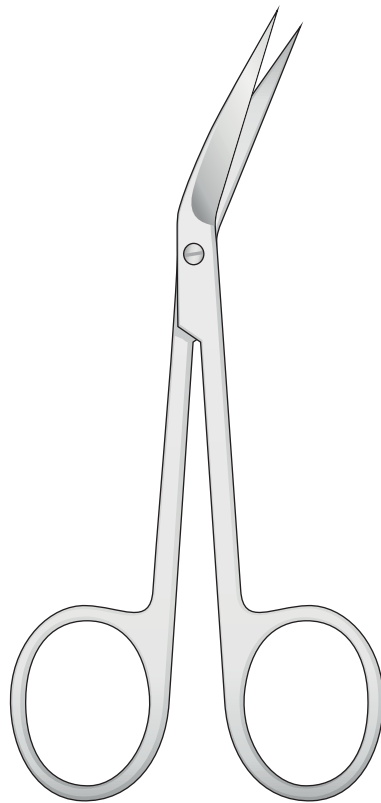
**FG-131**  
120 mm



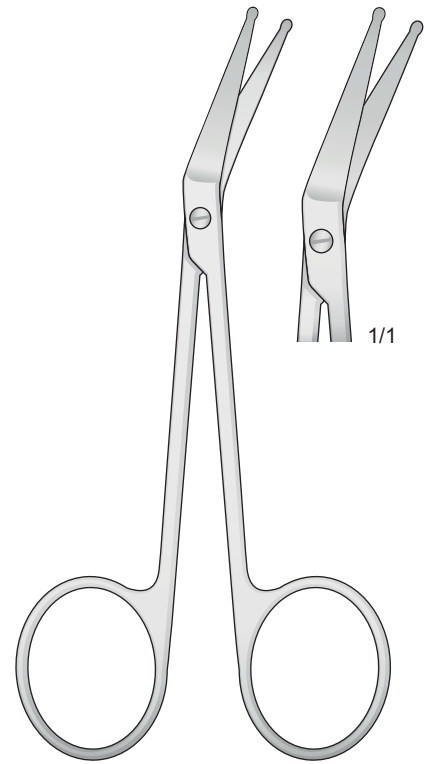
**FG-25/FG-26**  
110 mm



**FG-27**  
100 mm



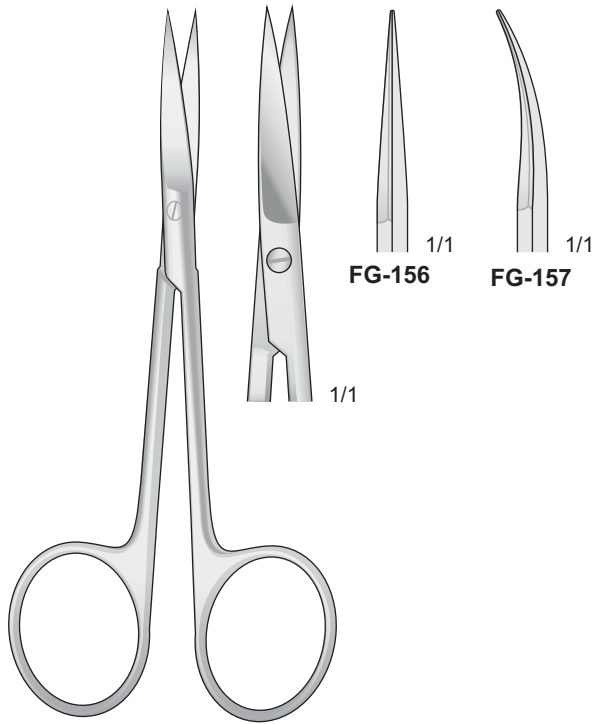
**LK-1**  
115 mm



**LOCKLIN MOD.**  
**LK-3**  
110 mm

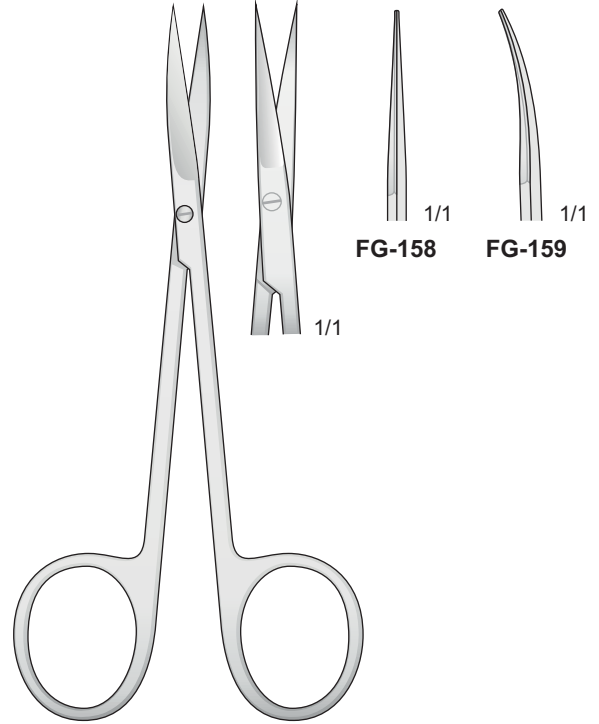


Dentellata - Sawedge - Gezahnt - Dentelé - Dentadas



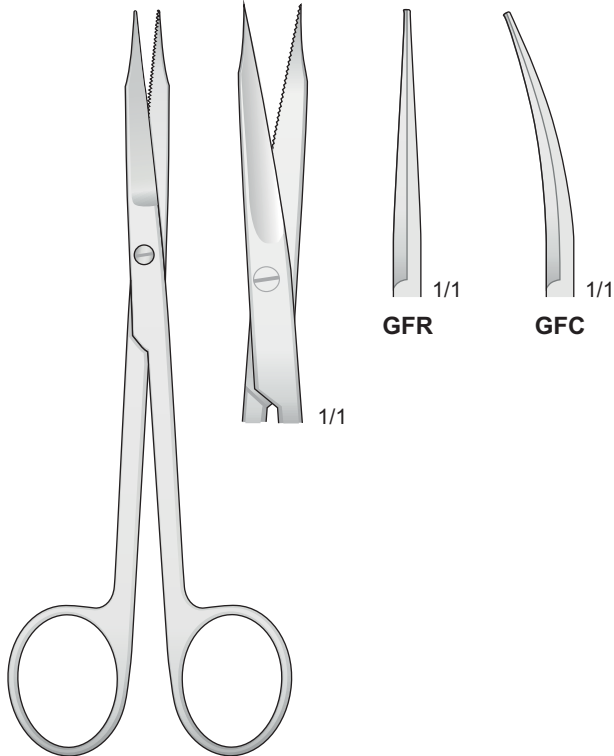
**FG-156/FG-157**  
110 mm

Dentellata - Sawedge - Gezahnt - Dentelé - Dentadas



**FG-158/FG-159**  
110 mm

Dentellata - Sawedge - Gezahnt - Dentelé - Dentadas



**GOLDMAN-FOX**  
**GFR/GFC**  
120 mm



Forbici delicate

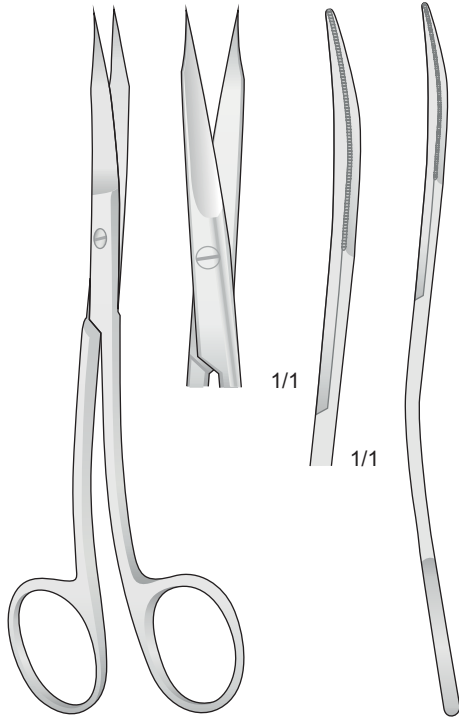
Delicate scissors

Feine Scheren

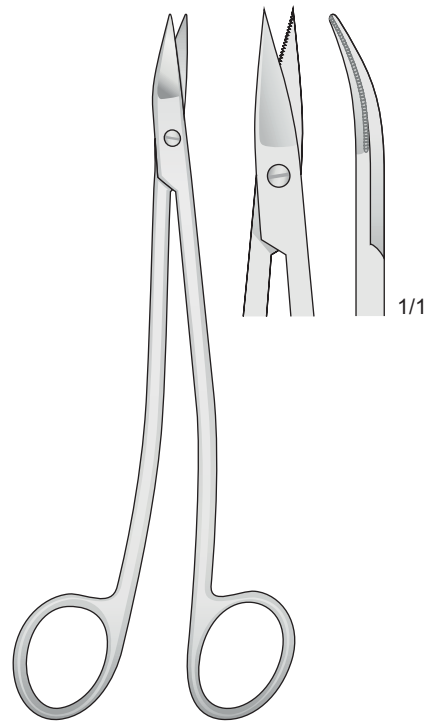
Ciseaux délicate

Tijeras finas

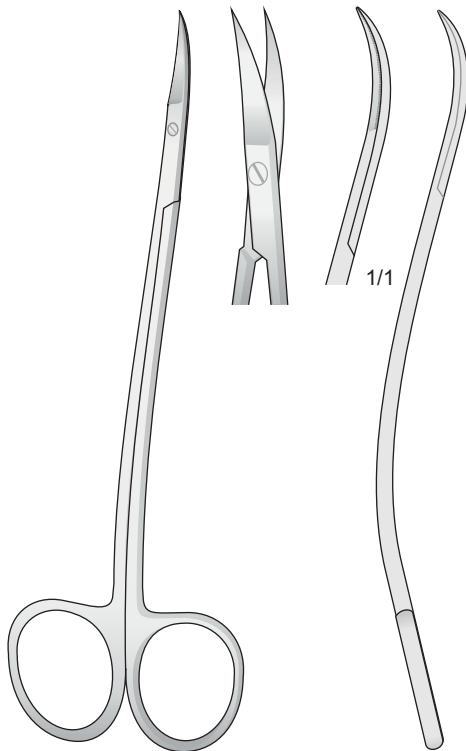
Dentellate  
Saw edge  
Gezahnt  
Dentelé  
Dentadas



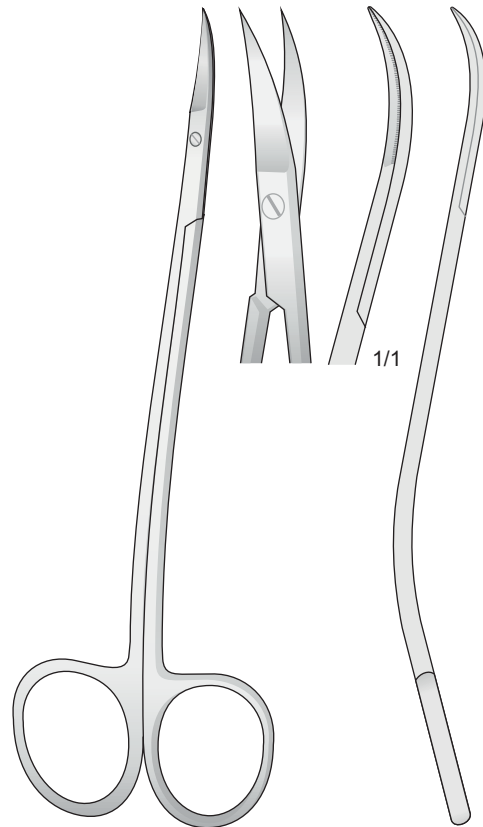
GOLDMAN-FOX S FORM  
**GFS**  
130 mm



NEUMANN  
**FG-20**  
130 mm



LA GRANGE  
**LG-1**  
115 mm

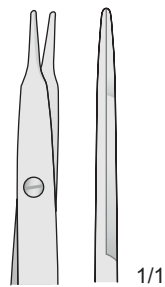
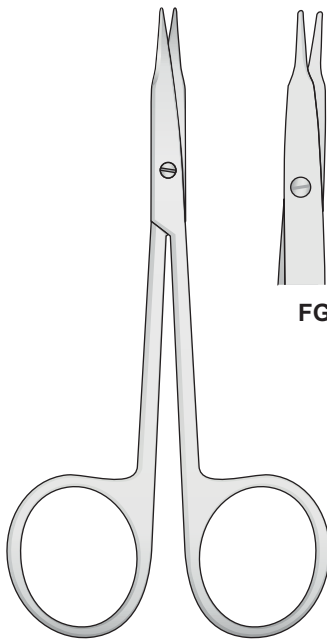


LA GRANGE  
**LG-6**  
155 mm

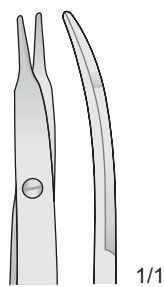


Smusse - Blunt - Stumpf - Mousses - Romas

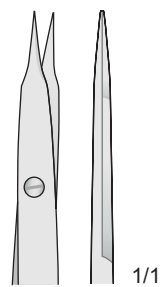
Acute - Pointed - Spitz - Pointus - Agudas



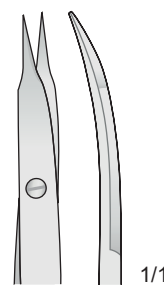
FG-50



FG-51



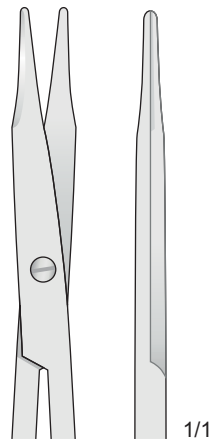
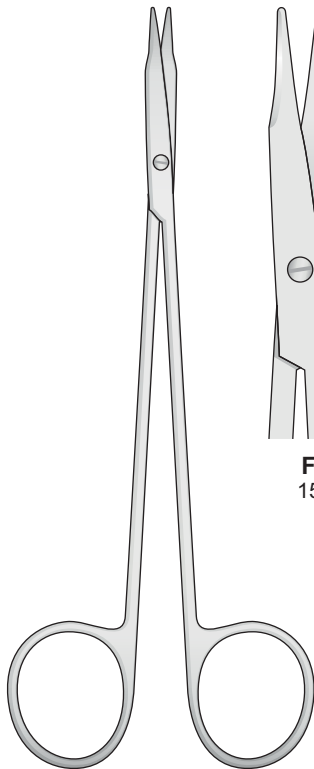
FG-52



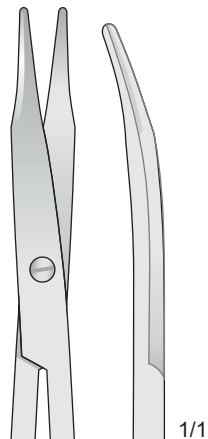
FG-53

STEVENS  
FG-50/FG-53  
110 mm

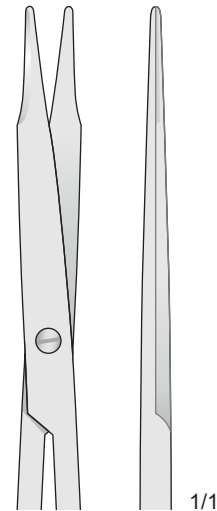
Smussa - Blunt - Stumpf  
Mousse - Romas



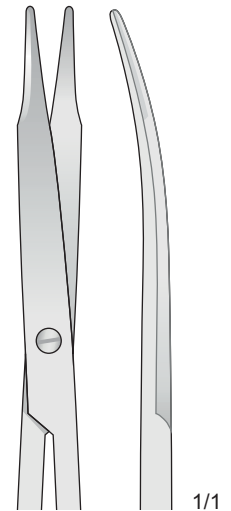
FG-54  
150 mm



FG-55  
150 mm

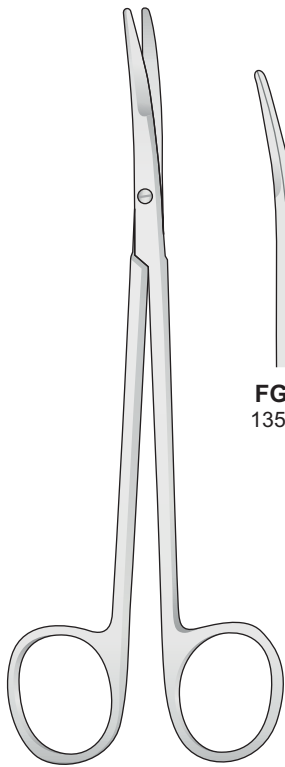


FG-56  
180 mm

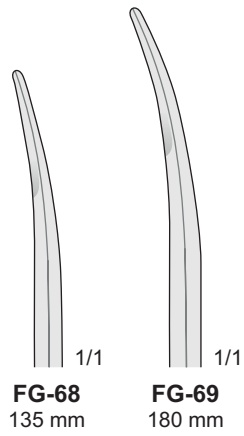


FG-57  
180 mm

REYNOLDS  
FG-54/FG-57

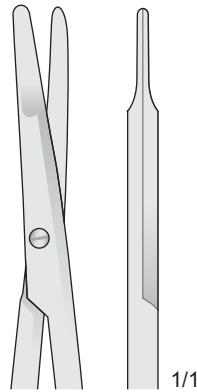


GLASSMAN  
FG-68/FG-69

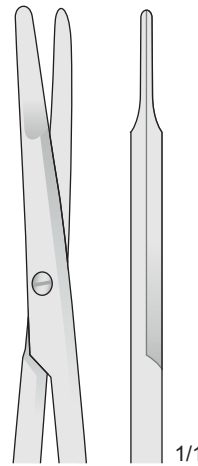


FG-68  
135 mm

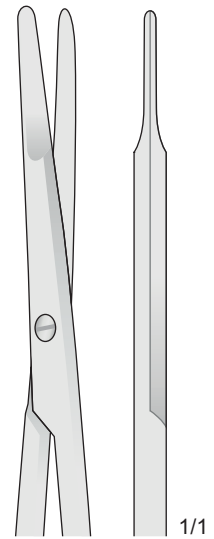
FG-69  
180 mm



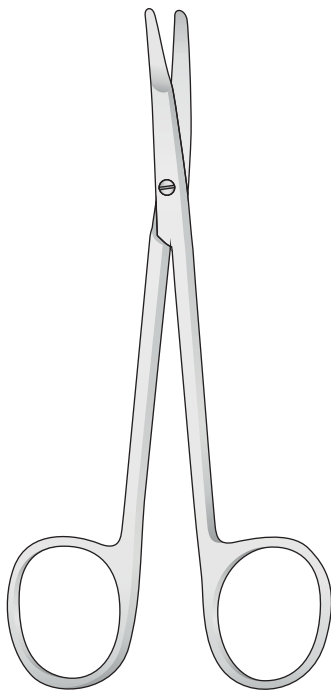
FG-66  
120 mm



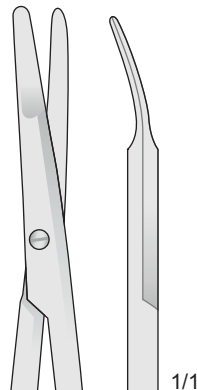
FG-19R  
135 mm



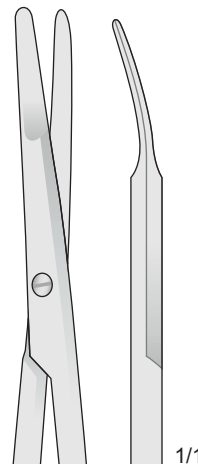
FG-6R  
150 mm



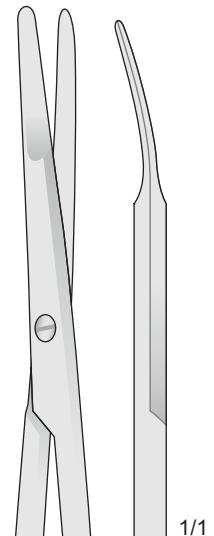
KILNER  
FG-6C/FG-66



FG-67  
120 mm



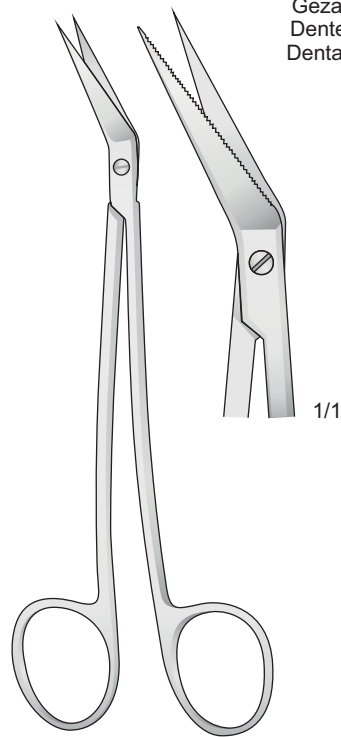
FG-19C  
135 mm



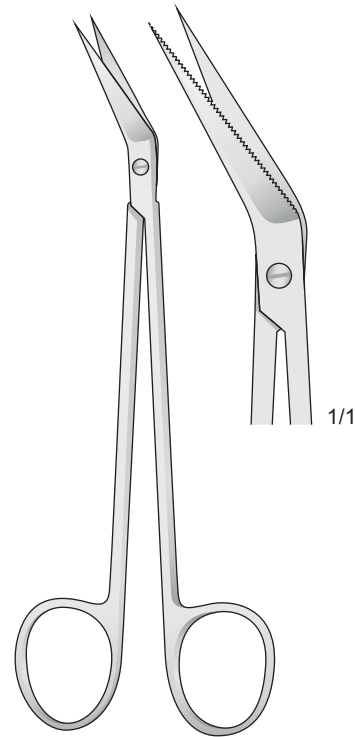
FG-6C  
150 mm



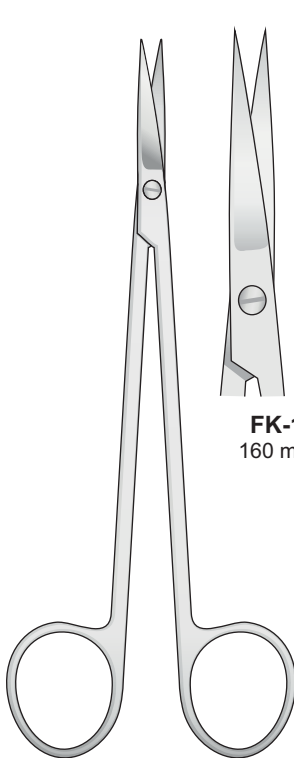
Dentellate  
Saw edge  
Gezahnt  
Dentelés  
Dentadas



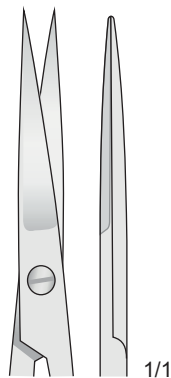
LOCKLIN  
**LK-2**  
160 mm



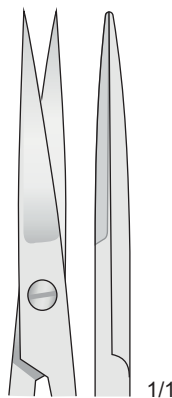
LOCKLIN  
**LK-4**  
160 mm



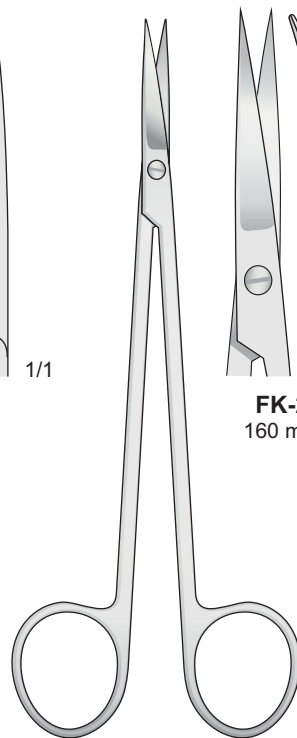
KELLY  
**FK-1/FK-87**



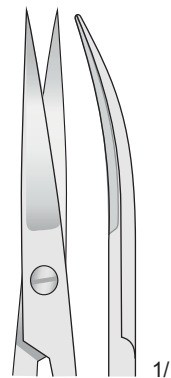
**FK-1**  
160 mm



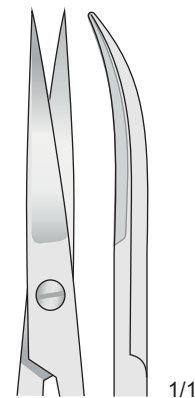
**FK-87**  
180 mm



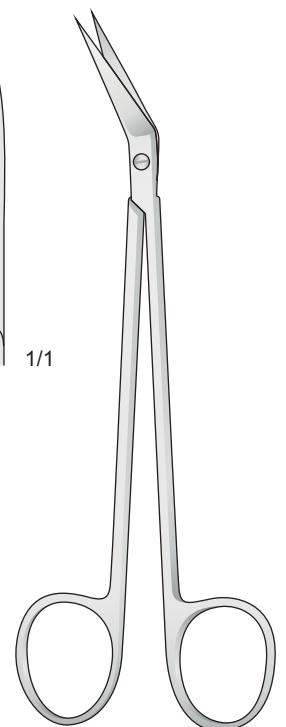
KELLY  
**FK-2/FK-88**



**FK-2**  
160 mm



**FK-88**  
180 mm

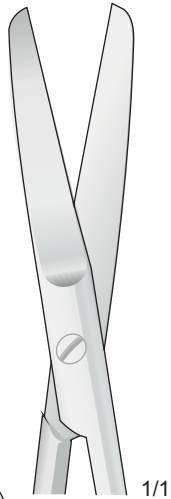
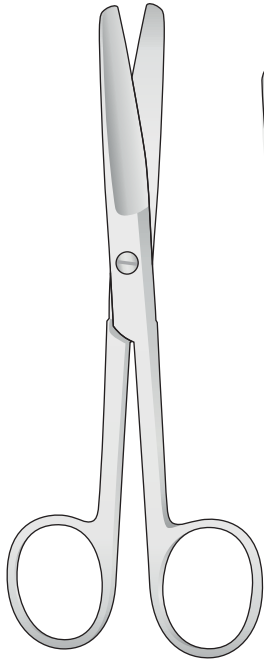


KELLY  
**FK-10**  
160 mm

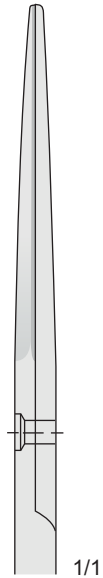


Standard

Smusse  
Blunt  
Stumpf  
Mousses  
Romas

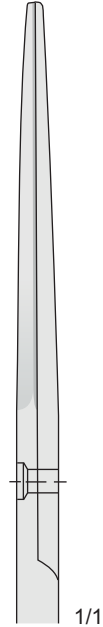


1/1



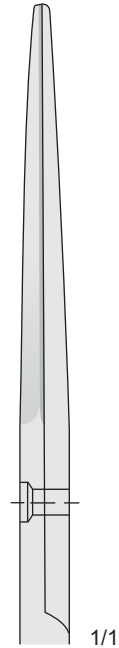
1/1

**FM-35**  
130 mm



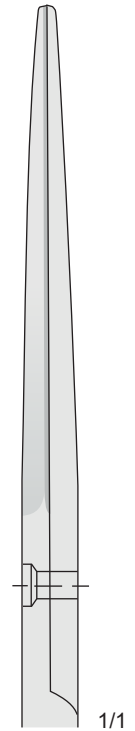
1/1

**FM-9**  
145 mm



1/1

**FM-37**  
165 mm

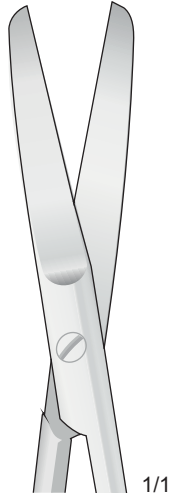
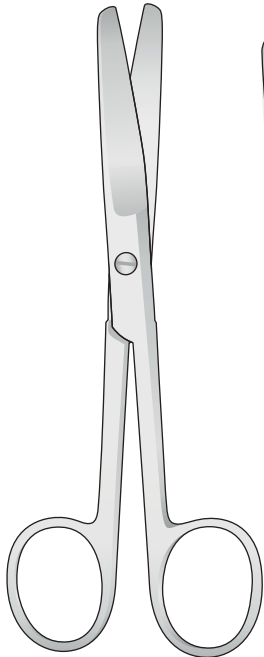


1/1

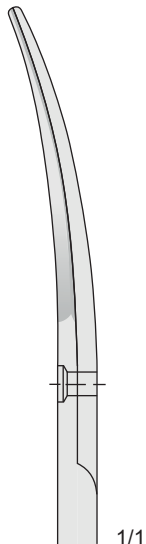
**FM-39**  
185 mm

**FM-9/FM-39**

Smusse - Blunt  
Stumpf - Mousses  
Romas

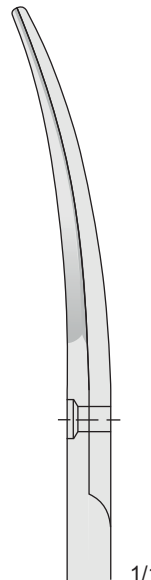


1/1



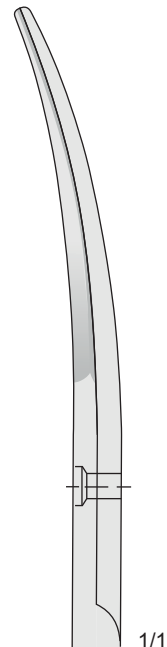
1/1

**FM-36**  
130 mm



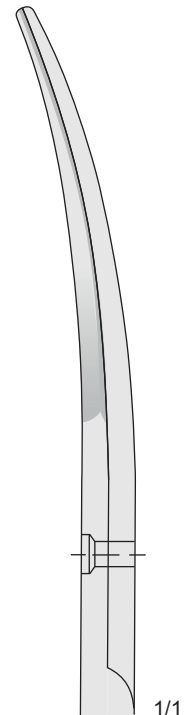
1/1

**FM-10**  
145 mm



1/1

**FM-38**  
165 mm



1/1

**FM-40**  
185 mm

**FM-10/FM-40**

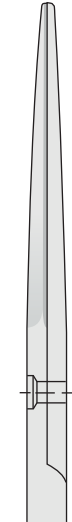




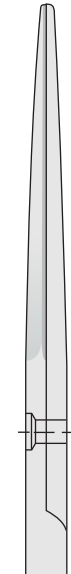
Standard



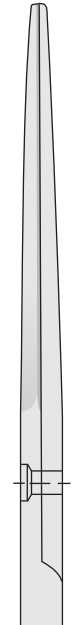
1/1



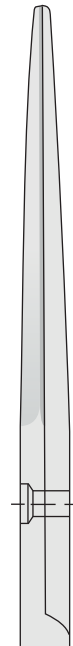
1/1



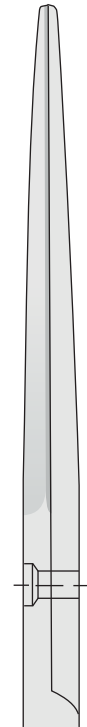
1/1



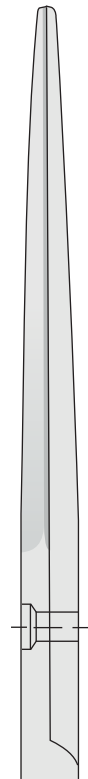
1/1



1/1



1/1



1/1

**FM-49**  
115 mm

**FM-27**  
130 mm

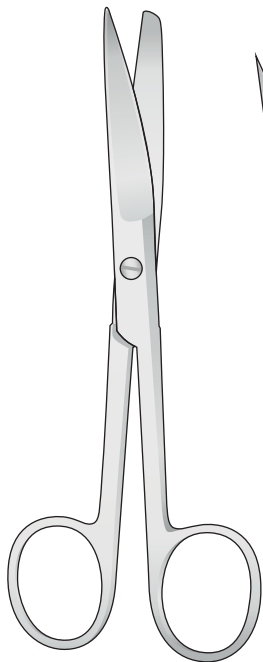
**FM-29**  
145 mm

**FM-31**  
165 mm

**FM-33**  
185 mm

**FM-62**  
200 mm

**FM-27/FM-62**



1/1



1/1



1/1



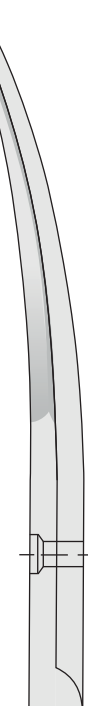
1/1



1/1



1/1



1/1

**FM-63**  
115 mm

**FM-28**  
130 mm

**FM-30**  
145 mm

**FM-32**  
165 mm

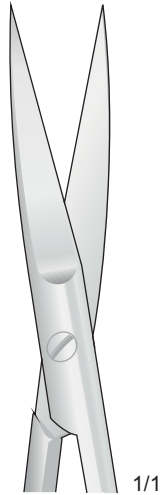
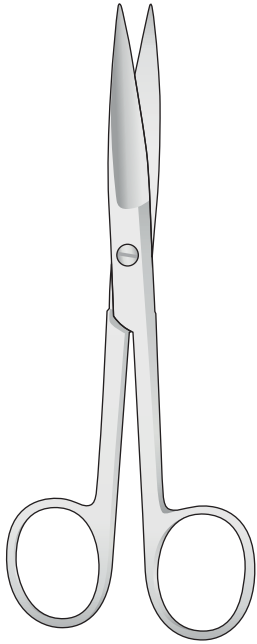
**FM-34**  
185 mm

**FM-28/FM-63**

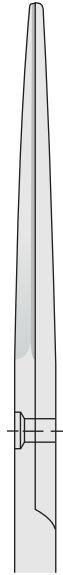


Standard

Acuta - Sharp  
Spitz - Aigu - Agudo



1/1



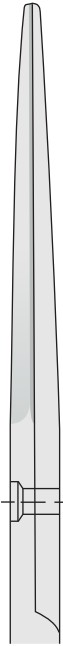
1/1

**FM-41**  
130 mm



1/1

**FM-7**  
145 mm



1/1

**FM-43**  
165 mm



1/1

**FM-45**  
185 mm

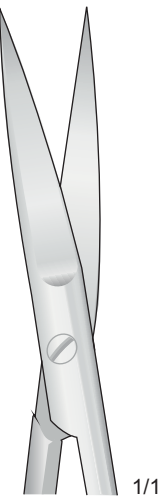
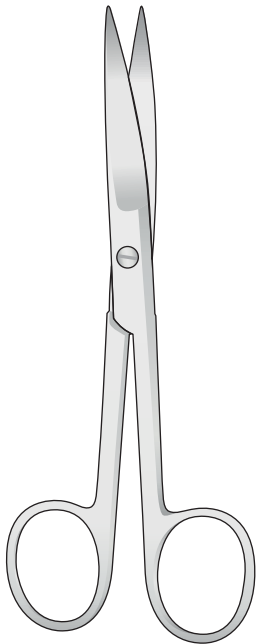


1/1

**FM-72**  
200 mm

**FM-41/FM-72**

Acuta - Sharp  
Spitz - Aigu - Agudo



1/1



1/1

**FM-42**  
130 mm



1/1

**FM-8**  
145 mm



1/1

**FM-44**  
165 mm



1/1

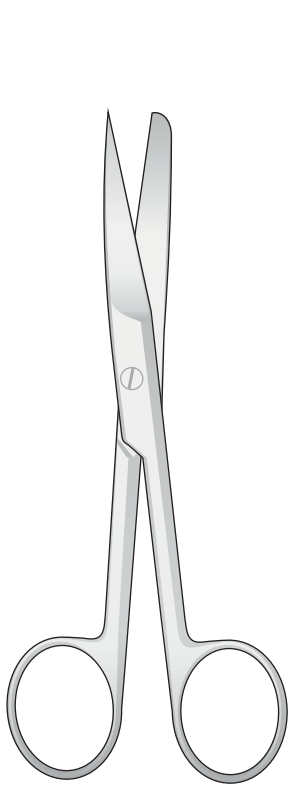
**FM-46**  
185 mm



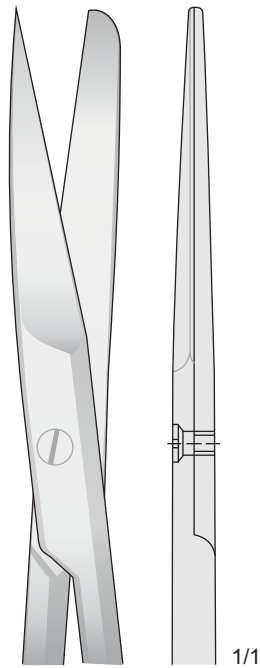
1/1

**FM-73**  
200 mm

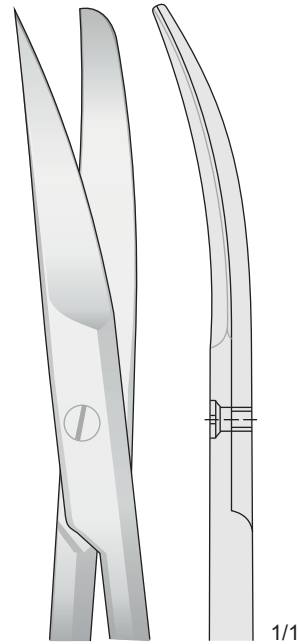
**FM-8/FM-73**



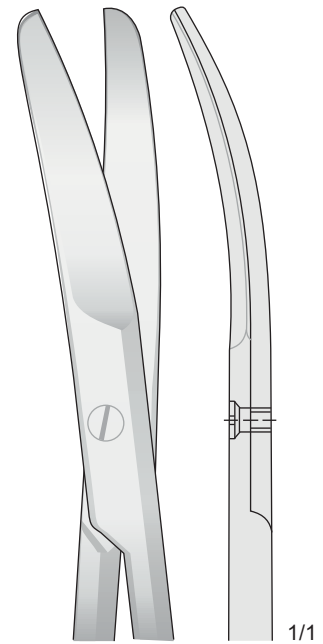
DEAVER  
**FG-47/FG-49**  
145 mm



**FG-47**  
145 mm

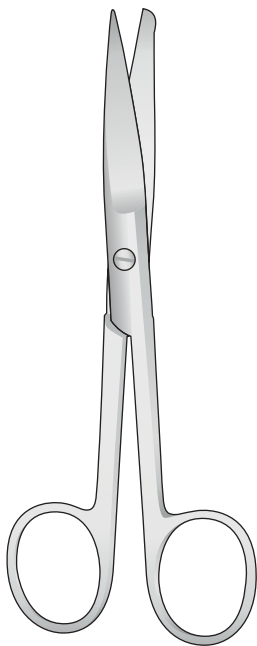


**FG-48**  
145 mm

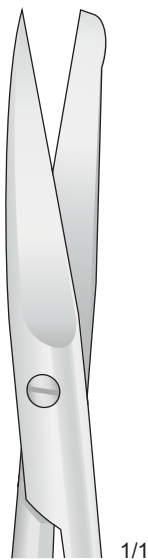


**FG-49**  
145 mm

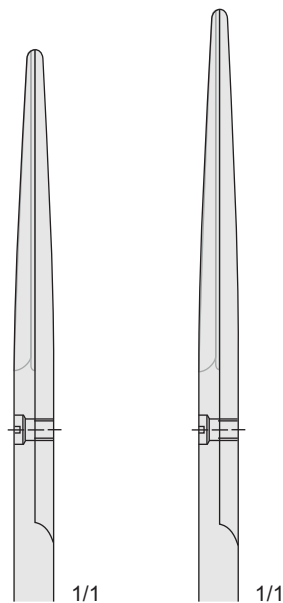
Forbici da incisione - Incision scissors  
Inzisionscheren - Ciseaux à incision  
Tijeras para incisión



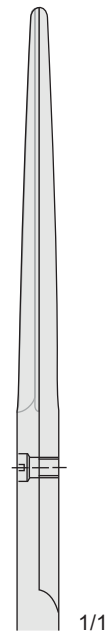
**FG-16/FG-18**



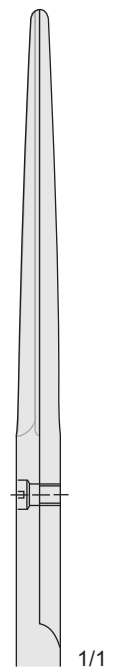
**FG-16**  
130 mm



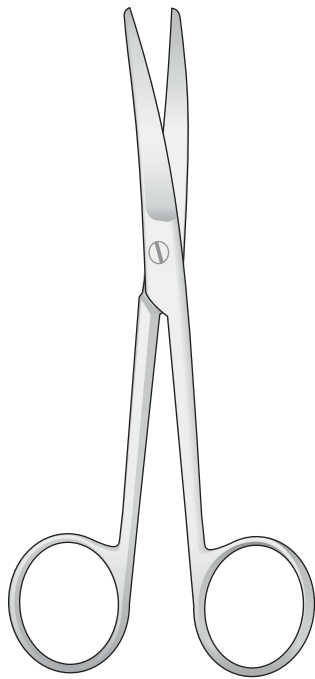
**FG-17**  
145 mm



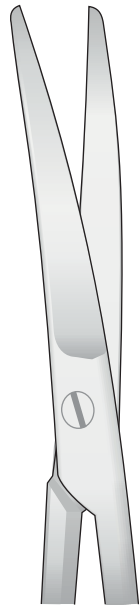
**FG-117**  
165 mm



**FG-18**  
185 mm



WERTHEIM  
FG-140/FG-142



1/1



1/1

FG-140  
145 mm



1/1

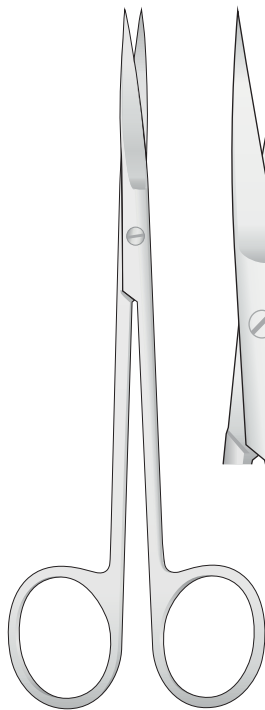
FG-141  
200 mm



1/1

FG-142  
230 mm

Con una lama dentellata  
With one blade serrated  
Mit eine Schneide gezahnt  
Avec lame dentèle  
Con una hoja dentada



JOSEPH  
FG-147/FG-148  
150 mm



FG-147  
150 mm



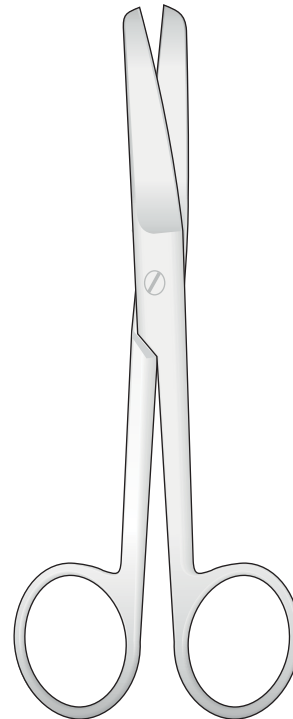
1/1



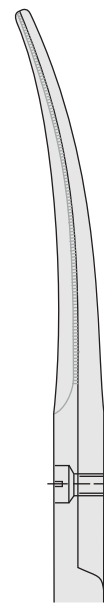
FG-148  
150 mm



1/1



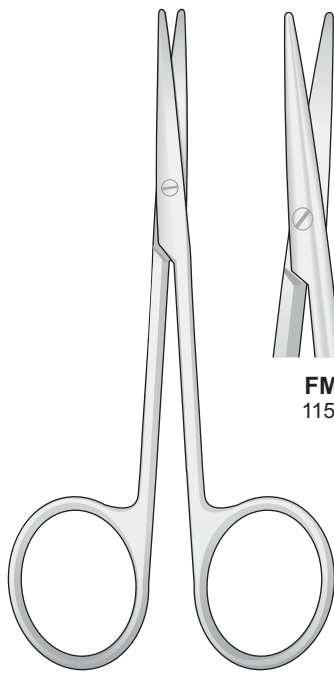
FG-116  
165 mm



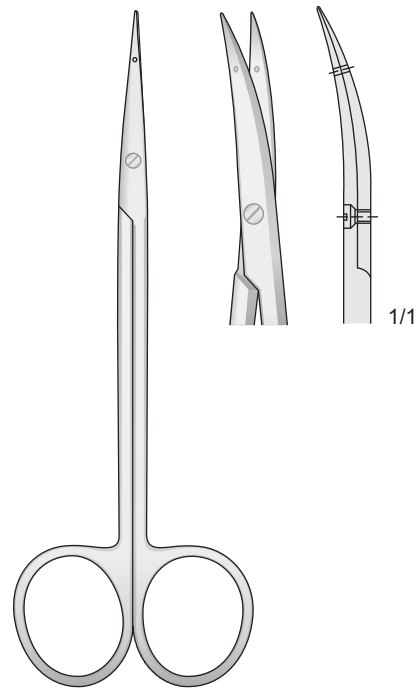
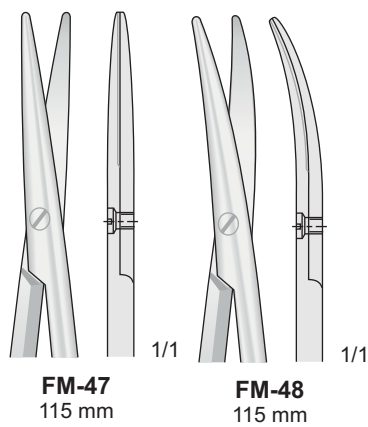
1/1



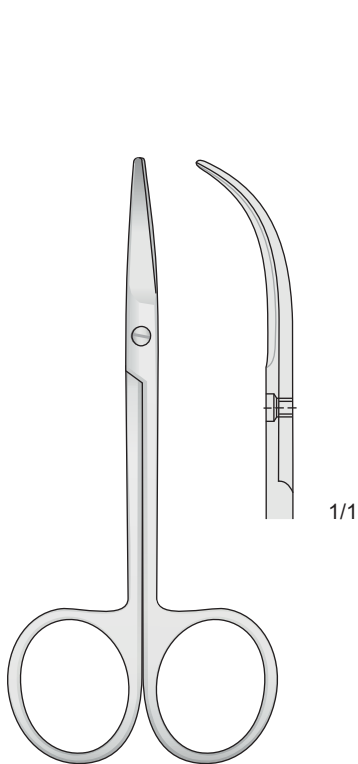
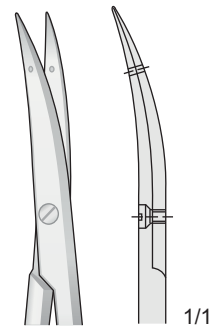
Con occhiello per sutura - With eye for suture  
Mit faden boh rung - Avec oeil pour les sutures  
Tijeras para ligaduras



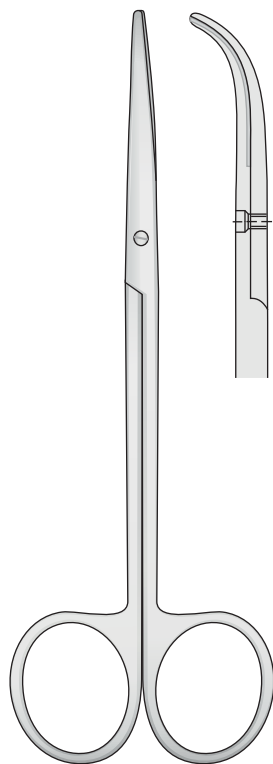
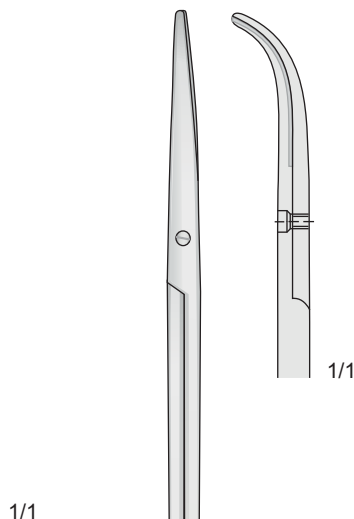
BABY - METZENBAUM  
FM-47/FM-48  
115 mm



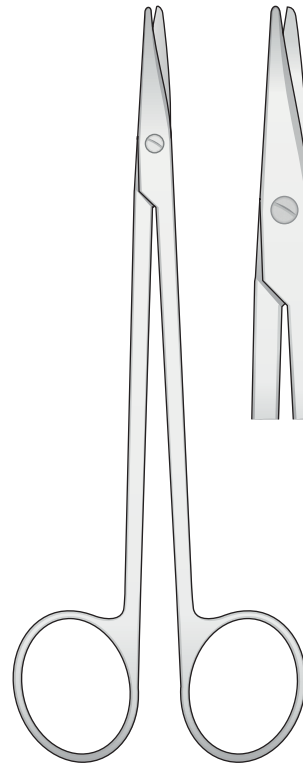
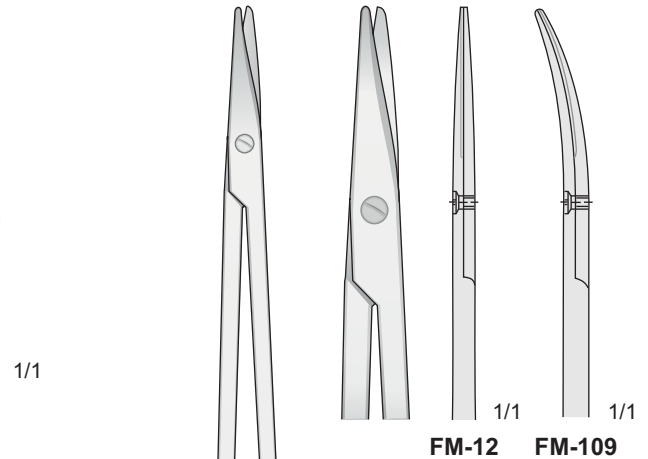
LITTLER  
FG-100  
120 mm



FOMON  
FG-43  
110 mm



METZENBAUN  
FM-12/FM-109  
140 mm

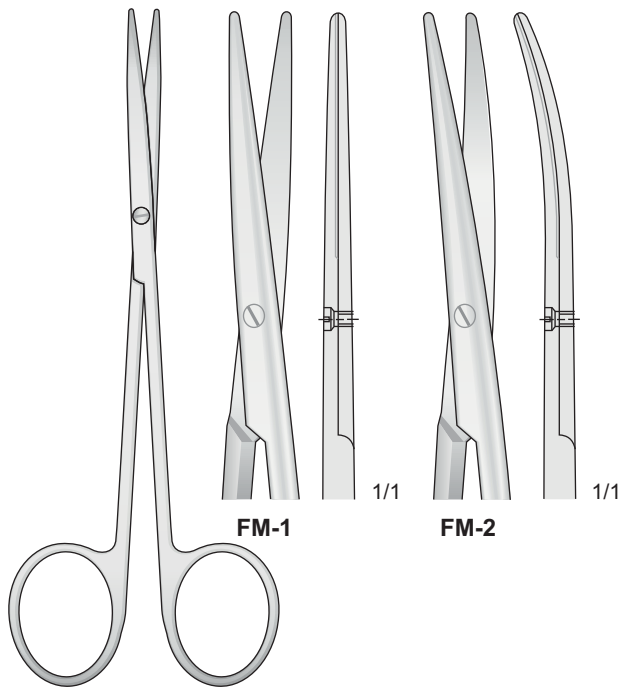


METZENBAUN  
FM-12/FM-109  
150 mm

FM-12 FM-109



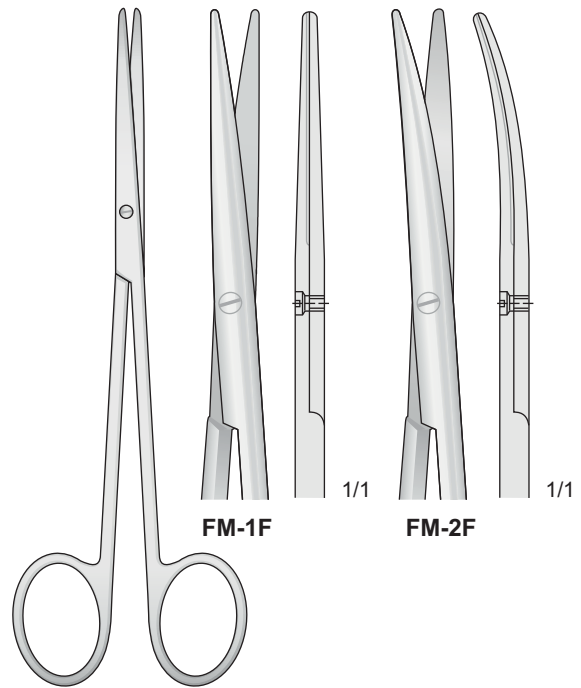
Forbici per dissezione - Dissecting Scissors  
Präparierscheren - Ciseaux à dissection - Tijeras para preparaciones



**FM-1**

**FM-2**

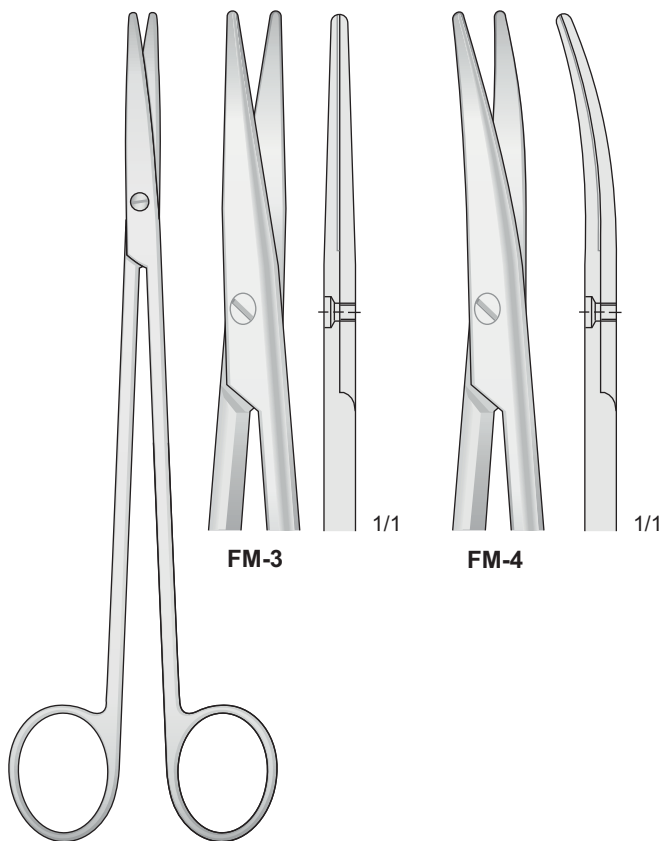
**METZENBAUM**  
**FM-1/FM-2**  
145 mm



**FM-1F**

**FM-2F**

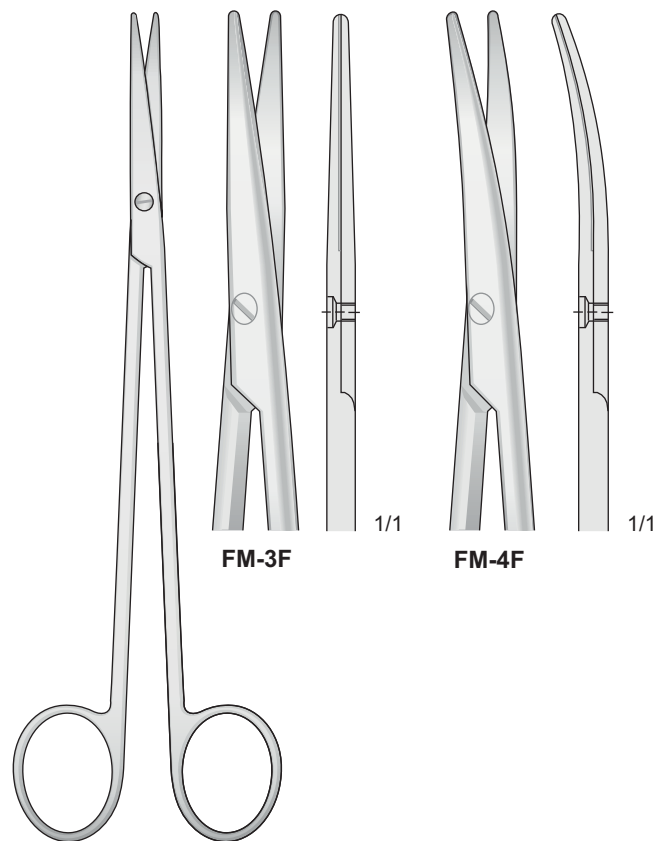
**METZENBAUM-FINE**  
**FM-1F/FM-2F**  
145 mm



**FM-3**

**FM-4**

**METZENBAUM**  
**FM-3/FM-4**  
185 mm



**FM-3F**

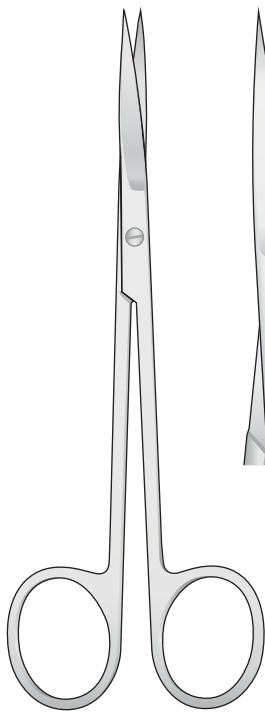
**FM-4F**

**METZENBAUM-FINE**  
**FM-3F/FM-4F**  
185 mm



Forbici per dissezione - Dissecting Scissors  
Präparierscheren - Ciseaux à dissection - Tijeras para preparaciones

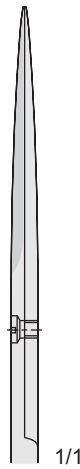
Acuta - Sharp  
Spitz - Aigu - Agudo



METZENBAUM  
FG-28/FG-14  
145 mm



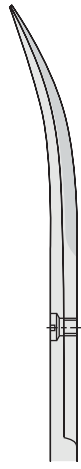
FG-28



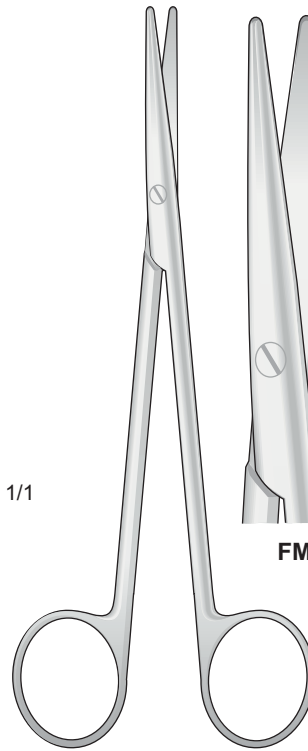
1/1



FG-14



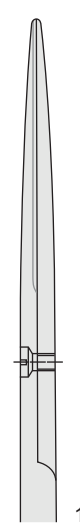
1/1



METZENBAUM  
FM-74/FM-75  
160 mm



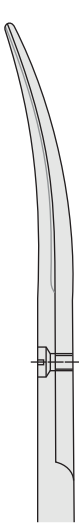
FM-74



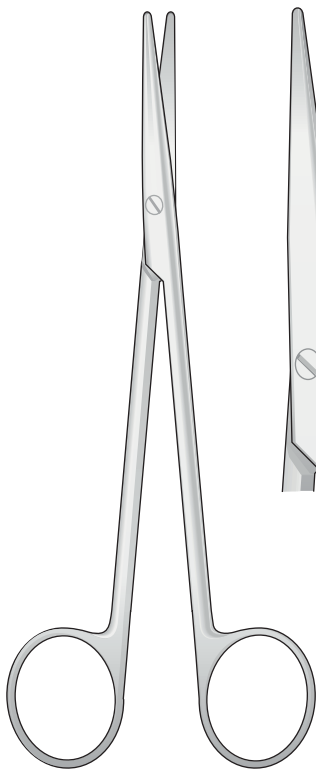
1/1



FM-75



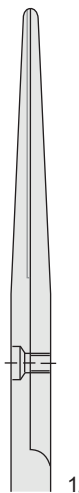
1/1



METZENBAUM  
FM-70/FM-71  
200 mm



FM-70



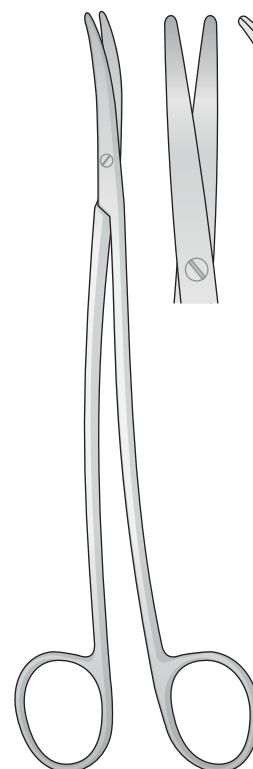
1/1



FM-71



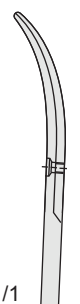
1/1



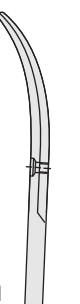
METZENBAUM-FINO  
FM-120 - 180 mm  
FM-121 - 200 mm  
FM-122 - 230 mm

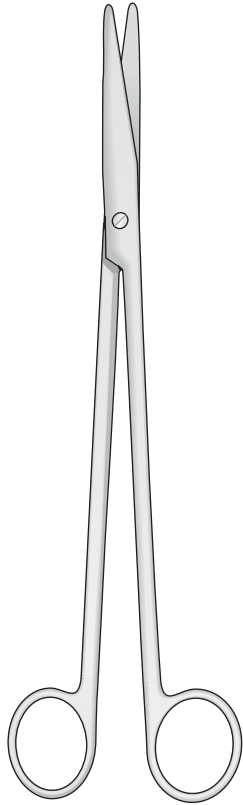


1/1

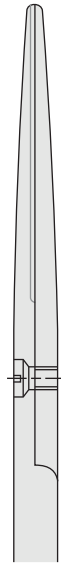
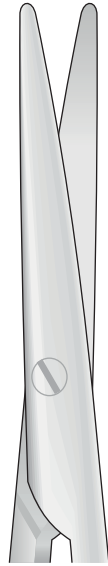


1/1

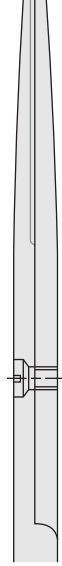




NELSON-METZENBAUM  
**FM-11/FM-114**



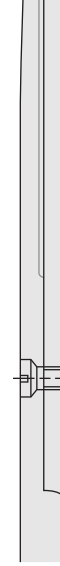
**FM-11**  
230 mm



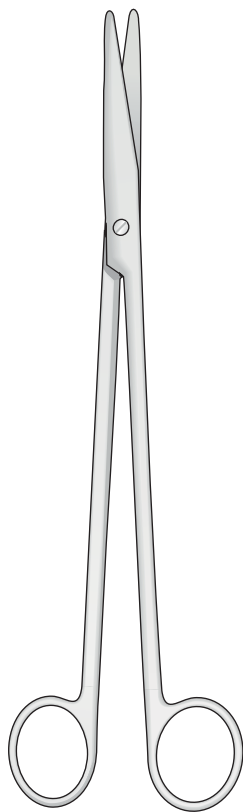
**FM-112**  
250 mm



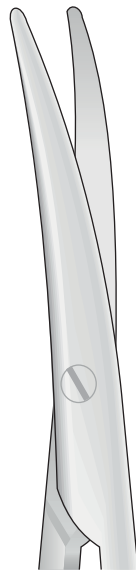
**FM-113**  
280 mm



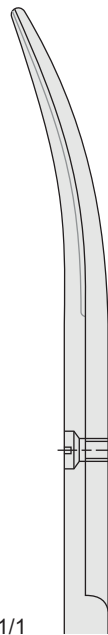
**FM-114**  
305 mm



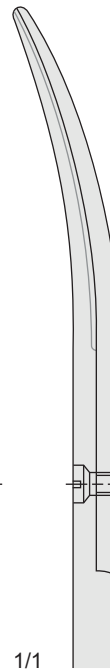
NELSON-METZENBAUM  
**FM-13/FM-117**



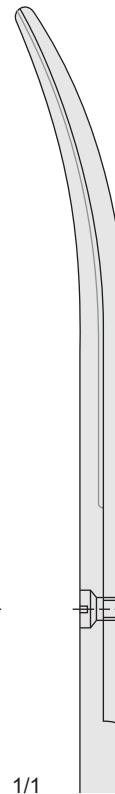
**FM-13**  
230 mm



**FM-115**  
250 mm



**FM-116**  
280 mm

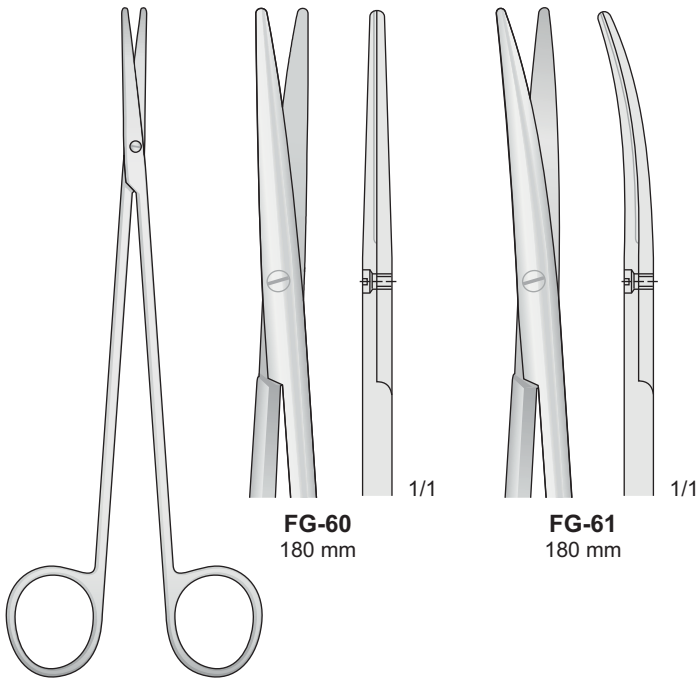


**FM-117**  
305 mm





Fine - Delicate - Fein - Fins - Finas

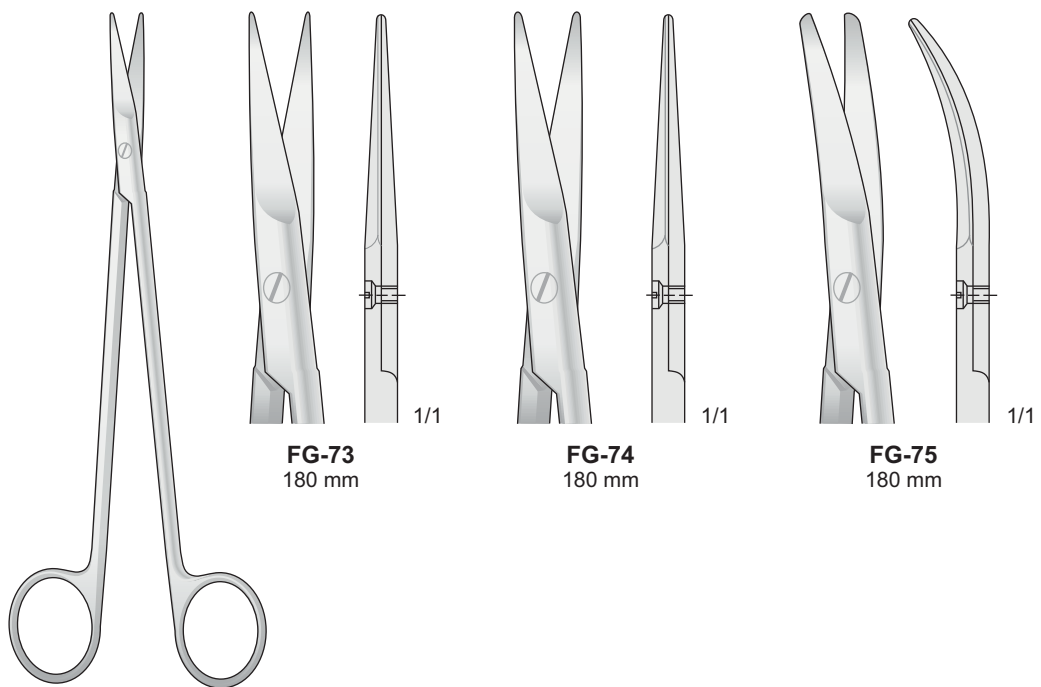


**FG-60**  
180 mm

**FG-61**  
180 mm

**TOENNIS-ADSON**  
**FG-60/FG-61**  
180 mm

Fine - Delicate - Fein - Fins - Finas



**FG-73**  
180 mm

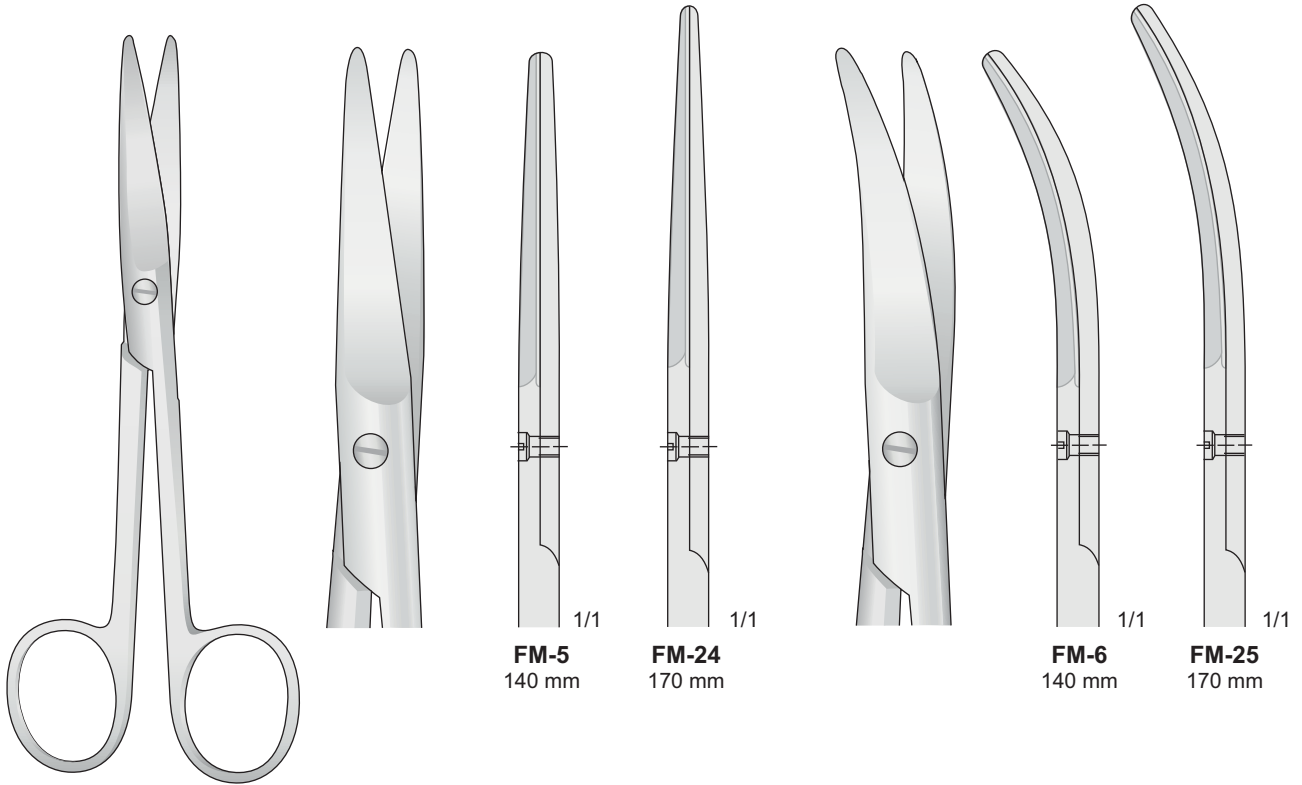
**FG-74**  
180 mm

**FG-75**  
180 mm

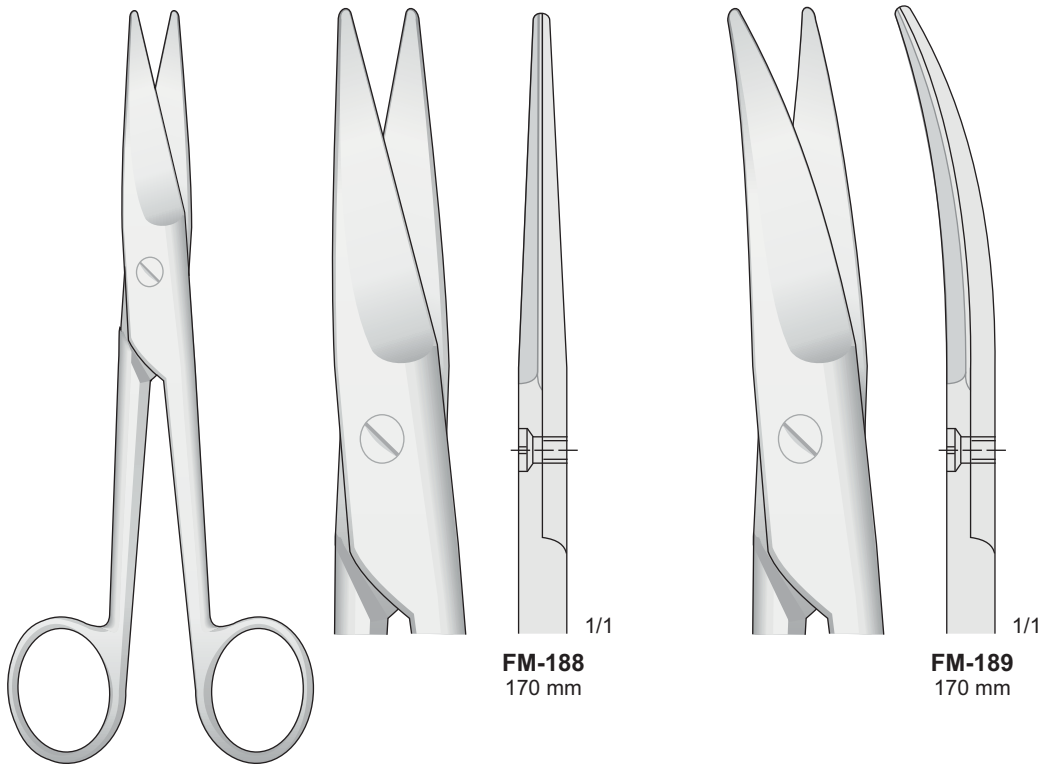
**TOENNIS**  
**FG-73/FG-75**  
180 mm



Forbici per dissezione - Dissecting scissors - Präparierscheren - Ciseaux à dissection - Tijeras para preparaciones



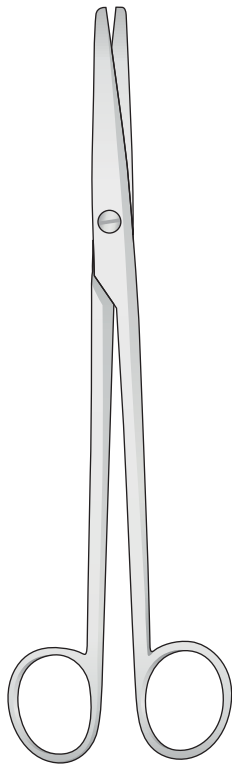
MAYO  
FM-5/FM-25



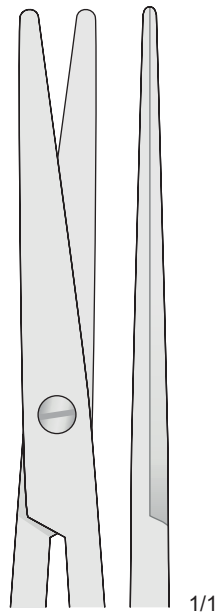
MAYO-NOBLE  
FM-188/FM-189



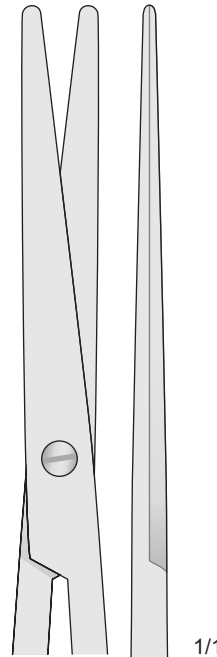
Forbici per dissezione - Dissecting scissors - Präparierscheren - Ciseaux à dissection - Tijeras para preparaciones



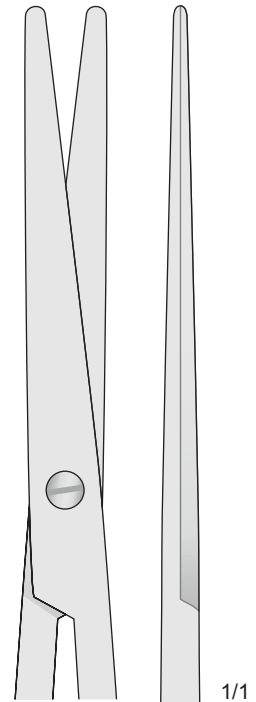
MAYO  
FM-80/FM-82



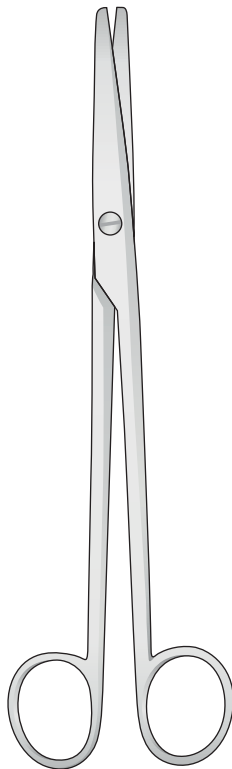
FM-80  
160 mm



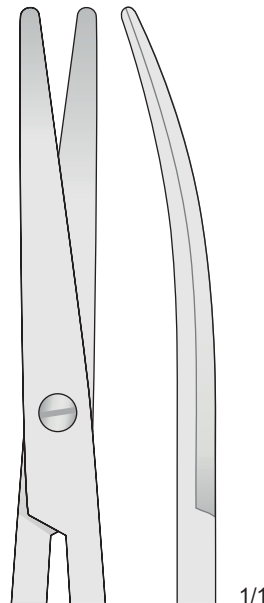
FM-81  
190 mm



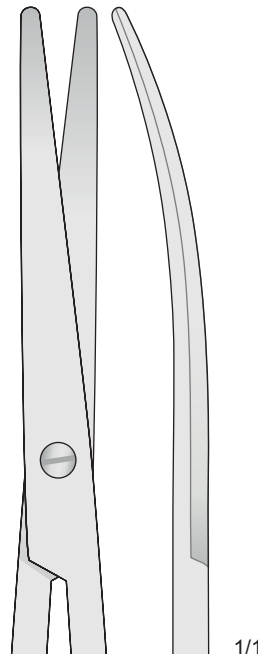
FM-82  
210 mm



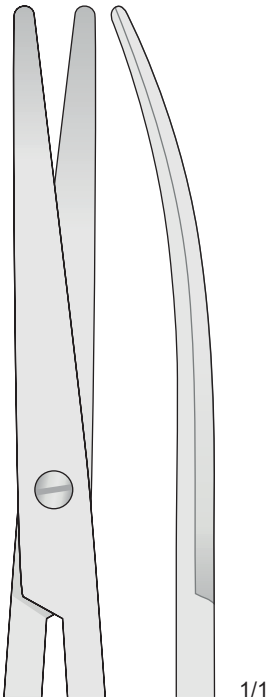
MAYO  
FM-83/FM-85



FM-83  
160 mm



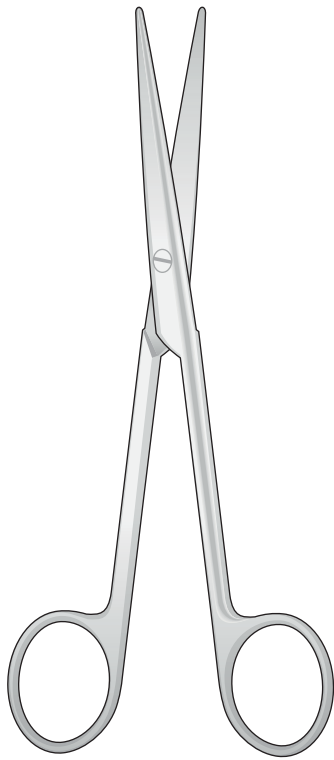
FM-84  
190 mm



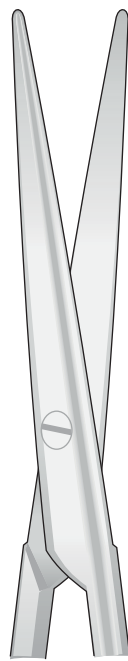
FM-85  
210 mm



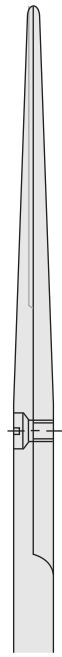
Fine - Delicate - Fein - Fins - Finas



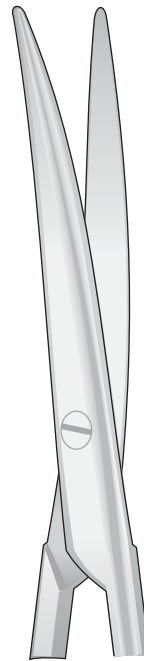
LEXER  
FM-180/FM-181  
165 mm



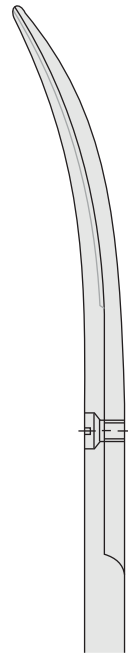
FM-180



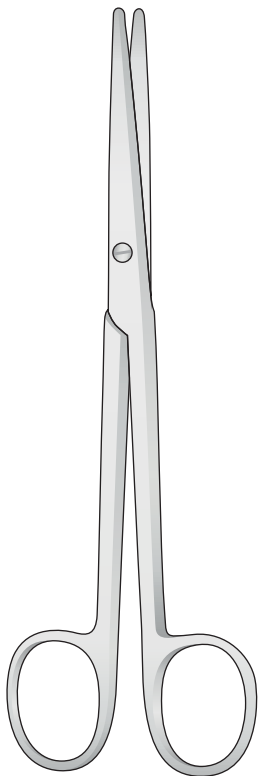
1/1



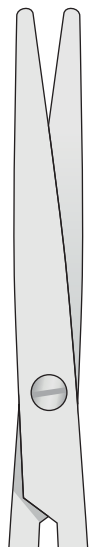
FM-181



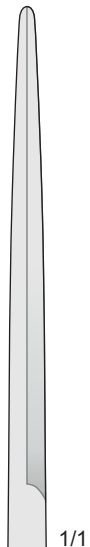
1/1



LEXER  
FM-86/FM-89



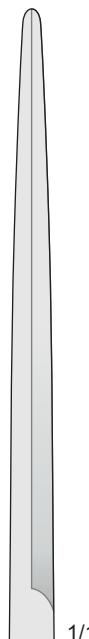
FM-86  
160 mm



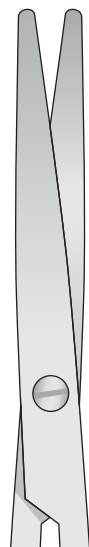
1/1



FM-87  
210 mm



1/1



FM-88  
160 mm



1/1



FM-89  
210 mm



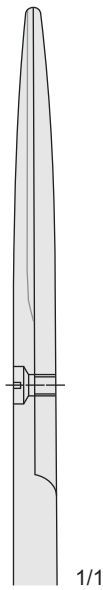
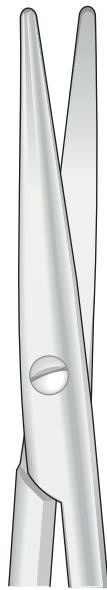
1/1



Forbici per dissezione - Dissecting Scissors - Präparierscheren - Ciseaux à dissection - Tijeras para preparaciones



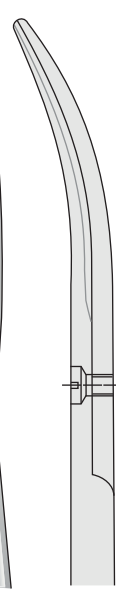
**FM-110**  
150 mm



1/1

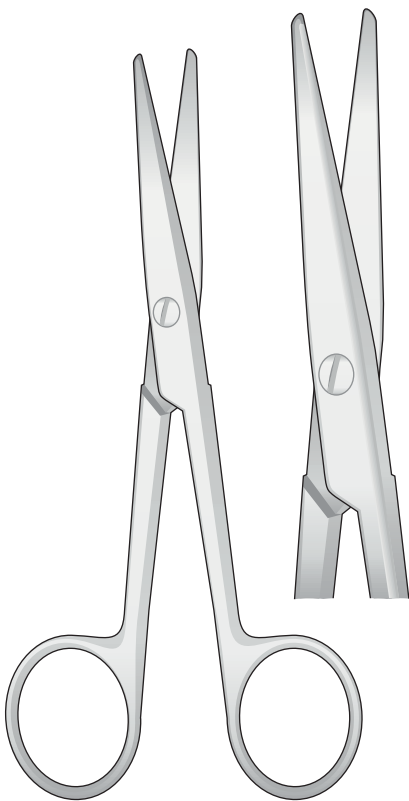


**FM-111**  
150 mm

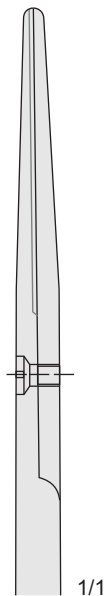


1/1

STILLE  
**FM-110/FM-111**  
150 mm

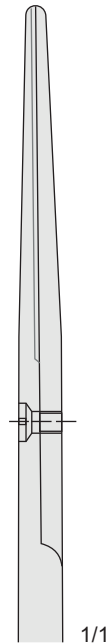


**FM-76**  
140 mm

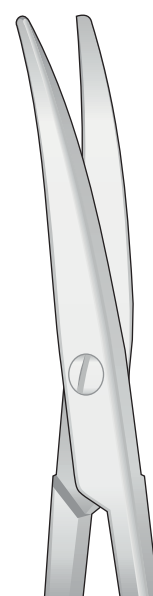


1/1

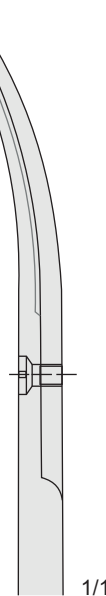
**FM-77**  
170 mm



1/1

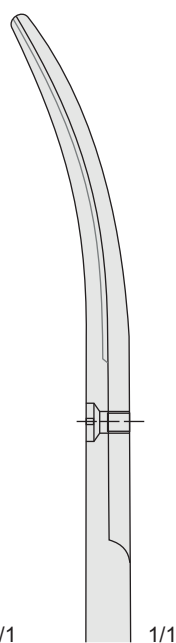


**FM-78**  
140 mm



1/1

**FM-79**  
170 mm

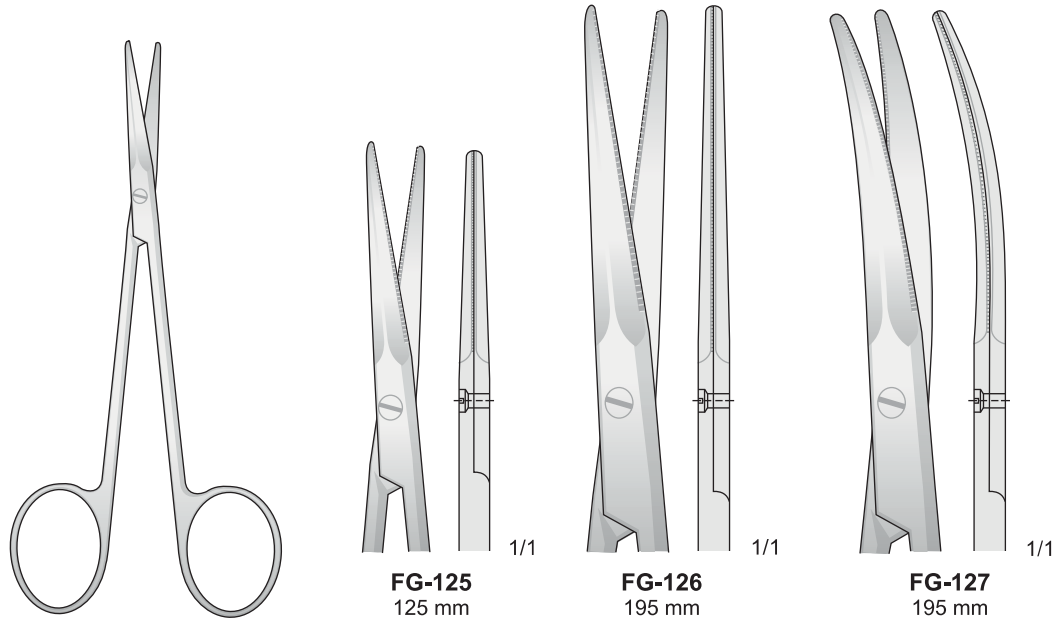


1/1

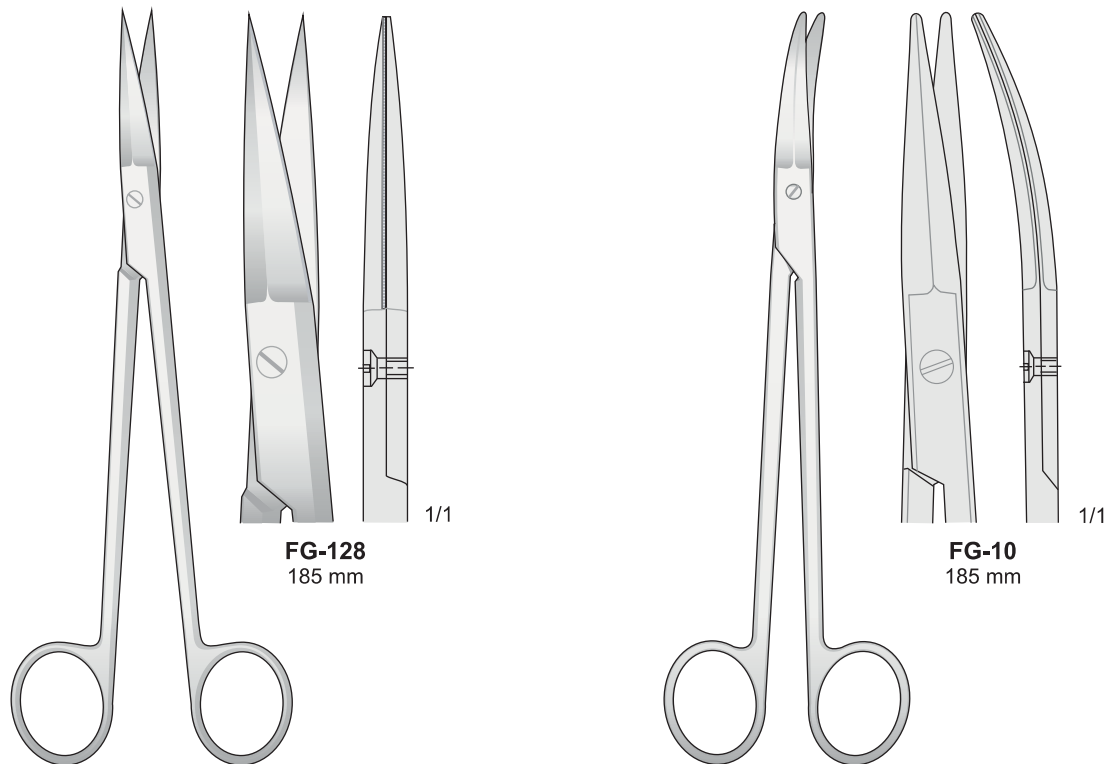
MAYO-STILLE  
**FM-76/FM-79**



Forbici per dissezione a taglio bilaterale - Bilateral Dissecting Scissors  
Präparierscheren - Ciseaux à dissection - Tijeras para preparaciones

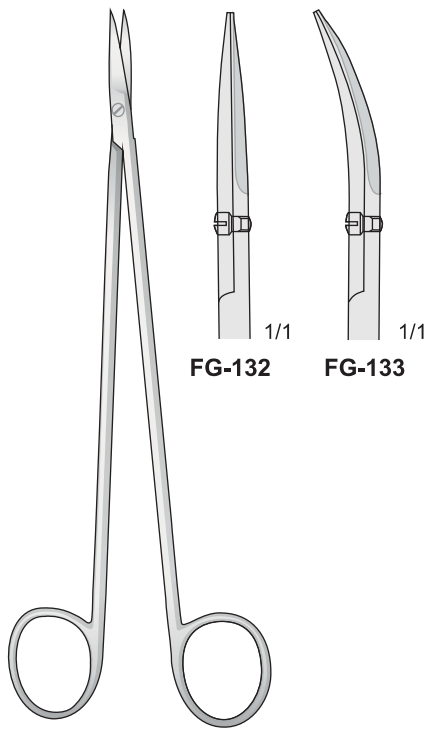


GORNEY  
FG-125/FG-127



FG-128  
185 mm

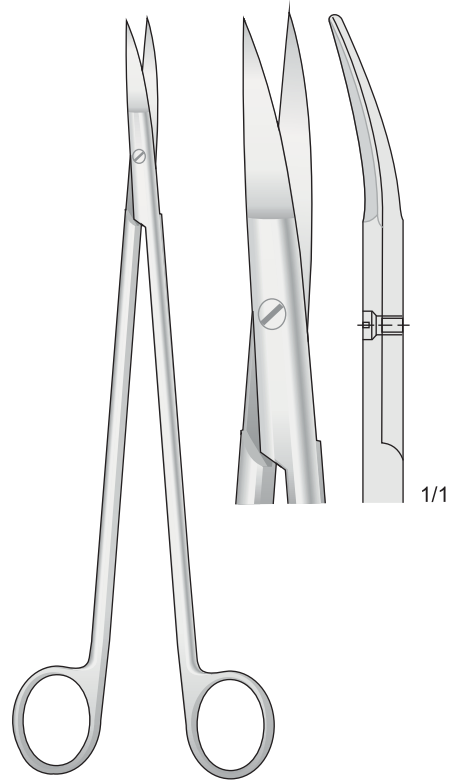
FG-10  
185 mm



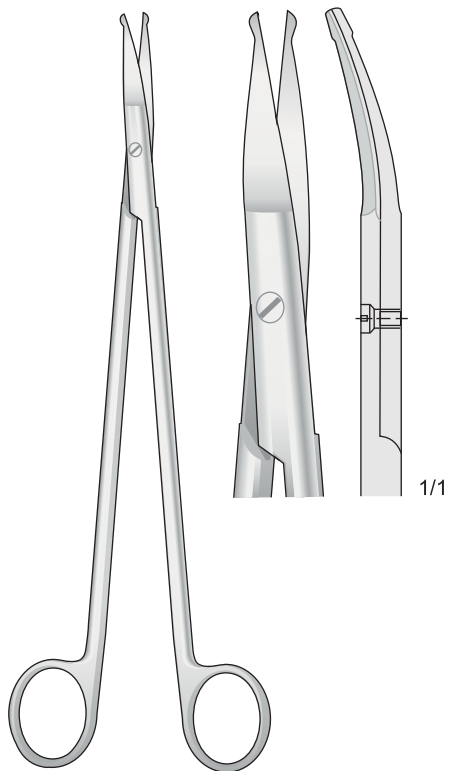
**FG-132**

**FG-133**

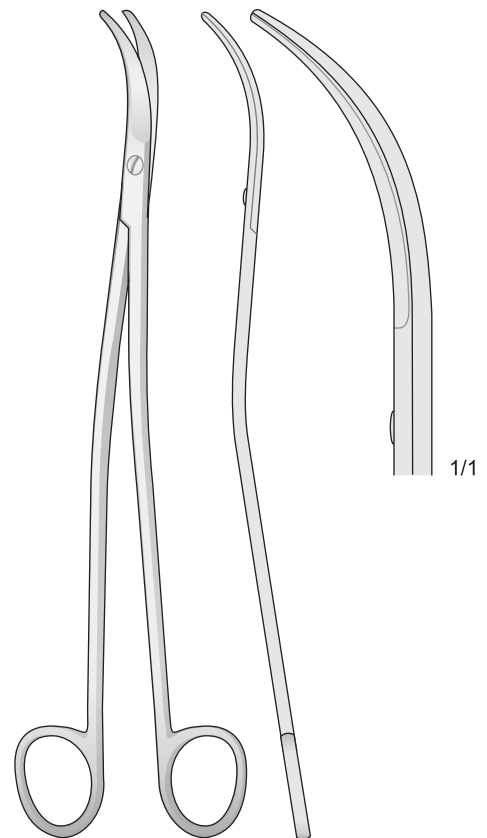
**FG-132/FG-133**  
190 mm



**STRULLY**  
**FG-106**  
220 mm



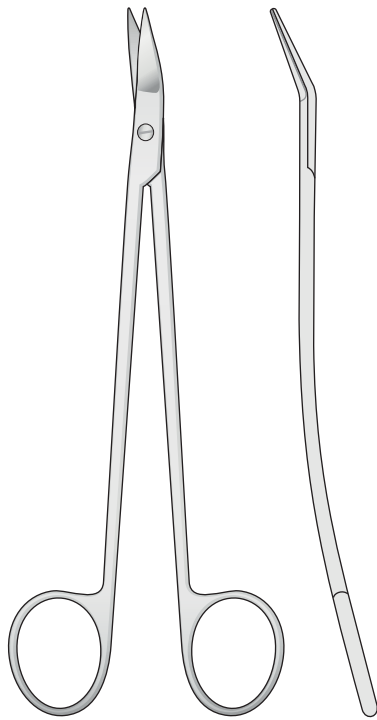
**STRULLY**  
**FG-107**  
220 mm



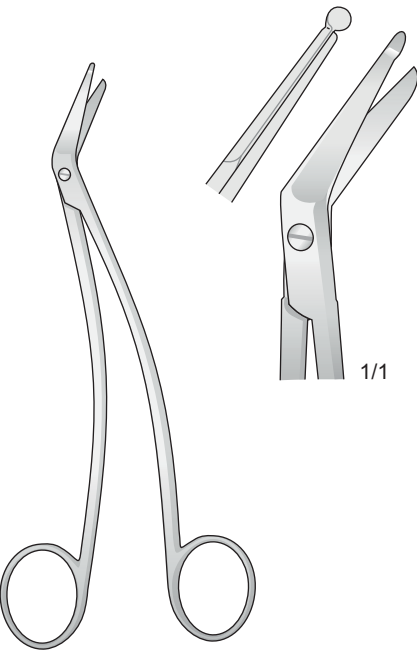
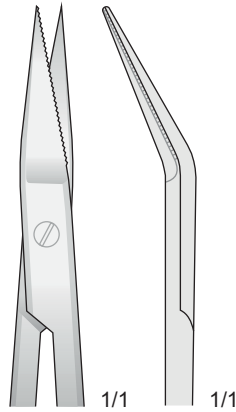
**SATINSKY**  
**FG-88**  
245 mm



Dentellata - Serrated - Gezahnt - Dentelé - Dentadas

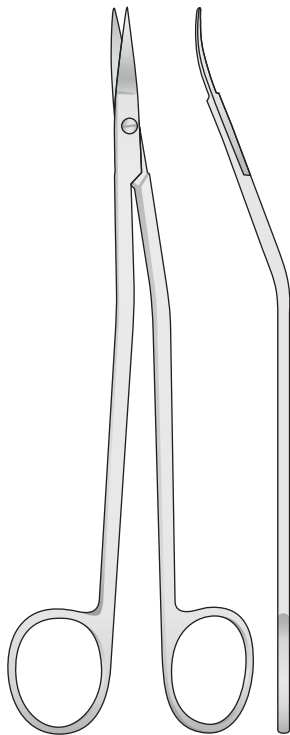


DEAN  
**DEAN**  
180 mm

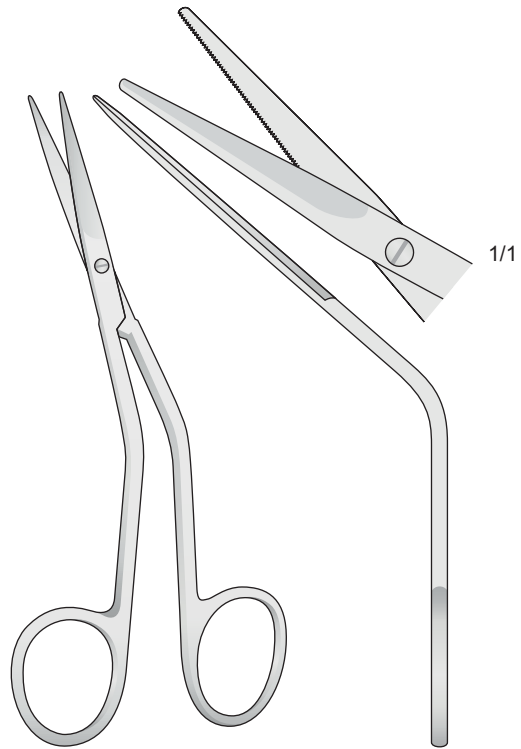


SCHMIEDEN-TAYLOR  
**FG-152**  
155 mm

Dentellata - Serrated - Gezahnt - Dentelé - Dentadas



DANDY  
**FG-42**  
175 mm

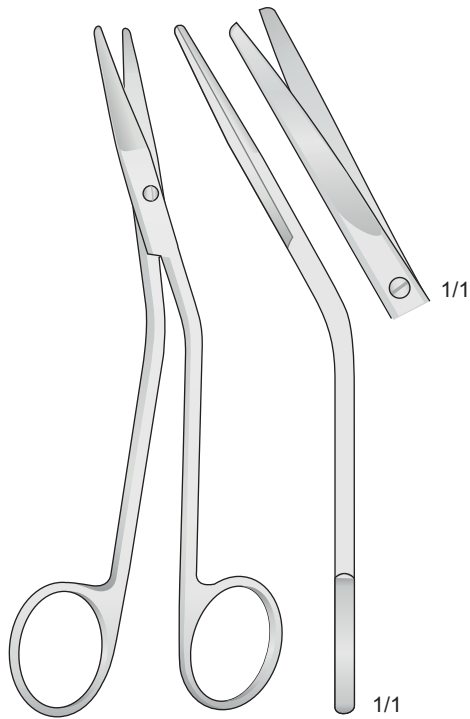


FOMON  
**FG-41**  
135 mm





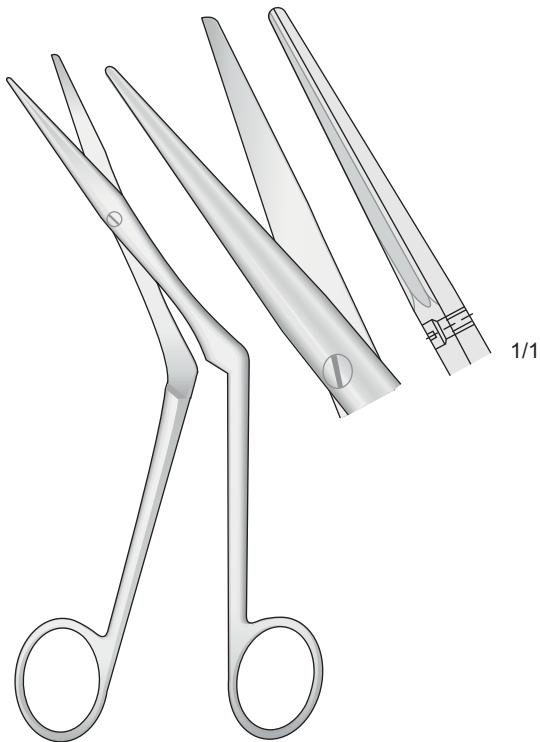
Forbici nasali - Nasal Scissors - Nasenscheren - Ciseaux nasaux - Tijeras nasales



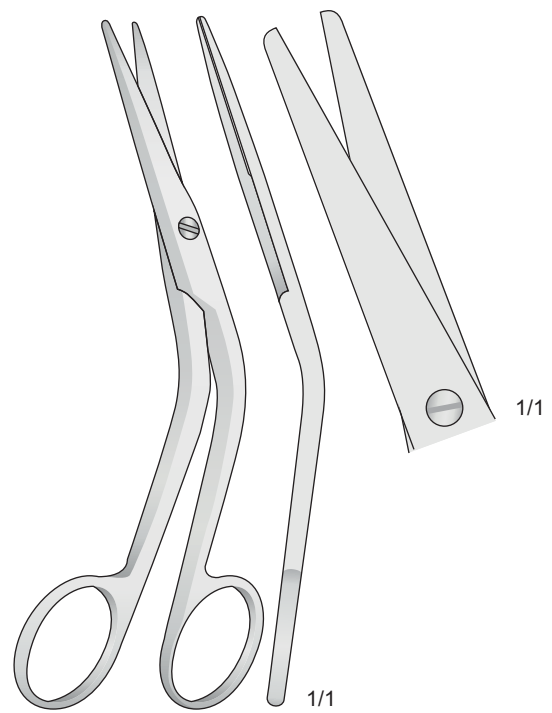
FOMON  
FG-7  
150 mm



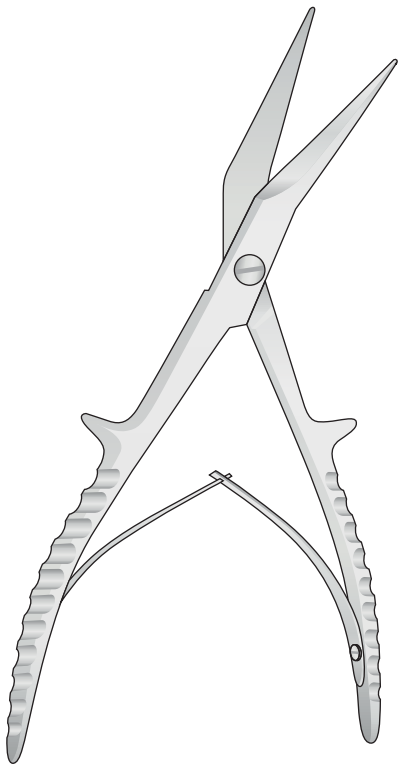
HEYMANN  
FG-8  
180 mm



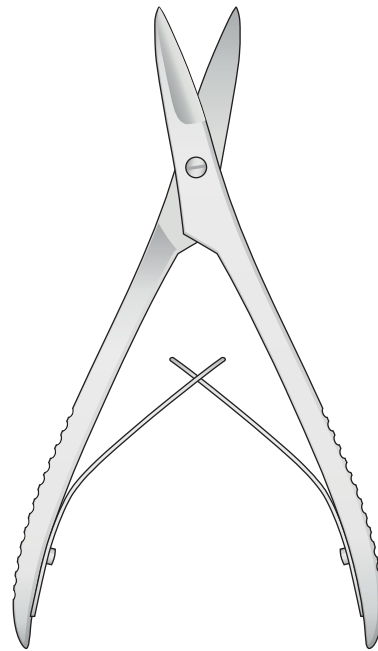
HEYMANN-KNIGHT  
FG-99  
175 mm



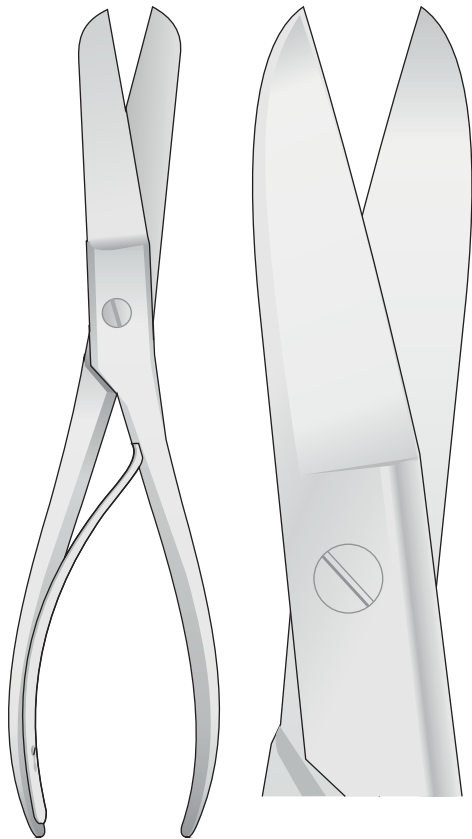
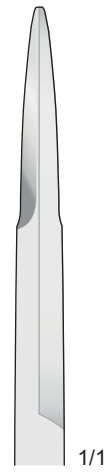
COTTLE  
FG-9  
160 mm



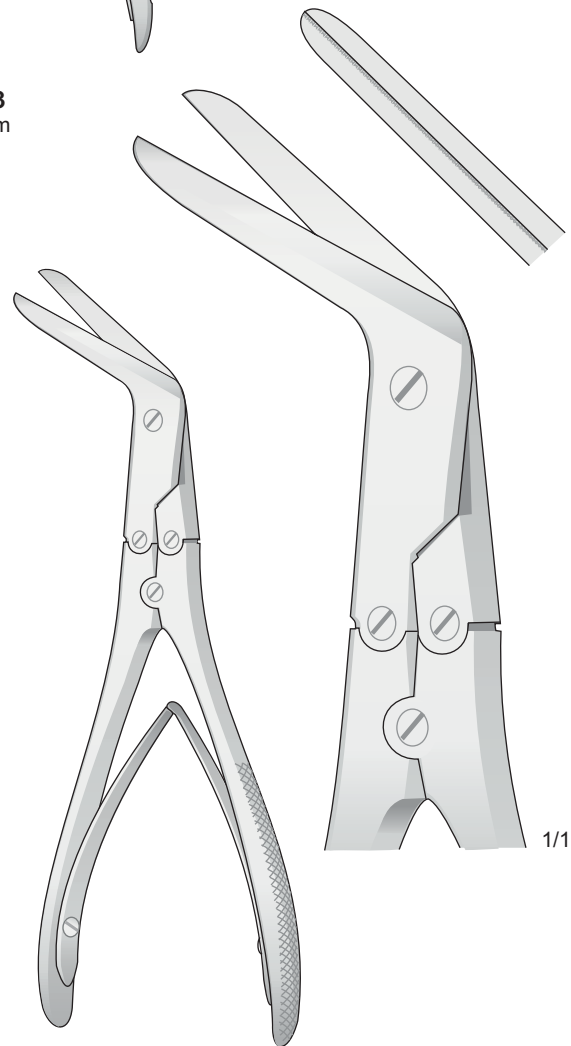
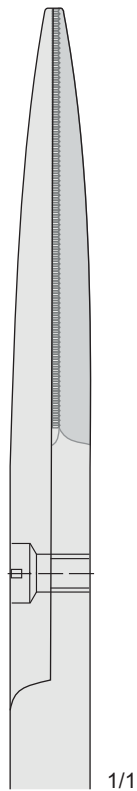
**FG-110**  
195 mm



**FO-63**  
160 mm

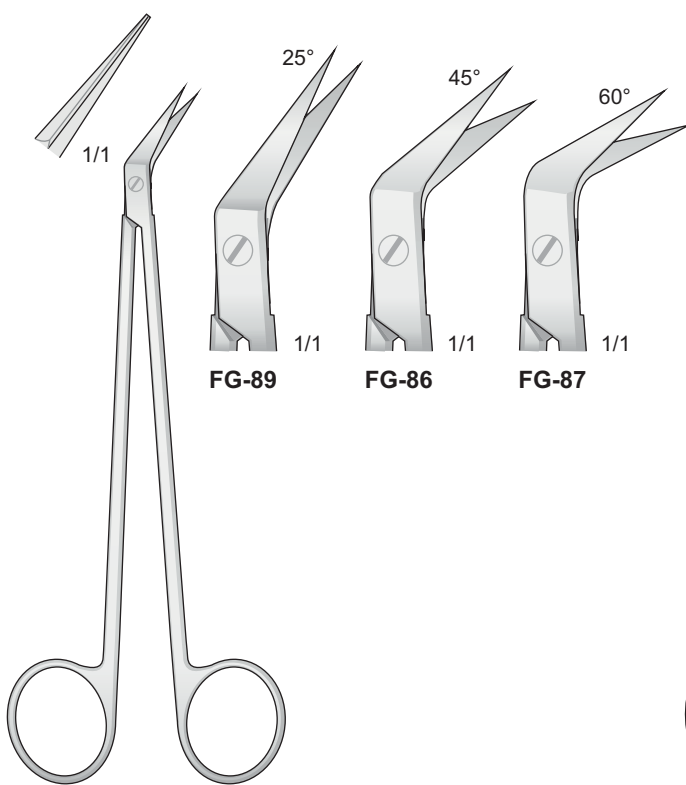


**FG-40**  
230 mm

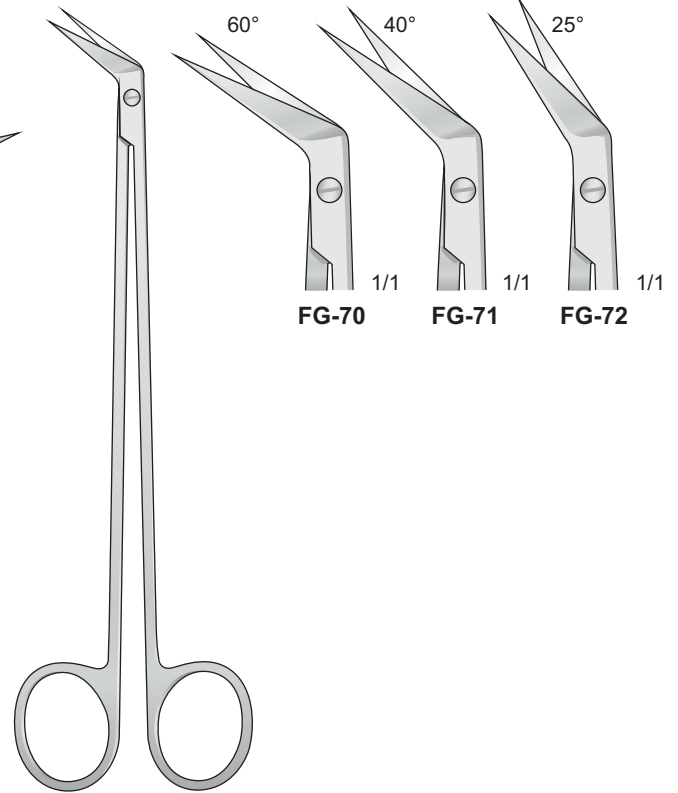


**KILLIAN**  
**FO-143**  
210 mm

1/1

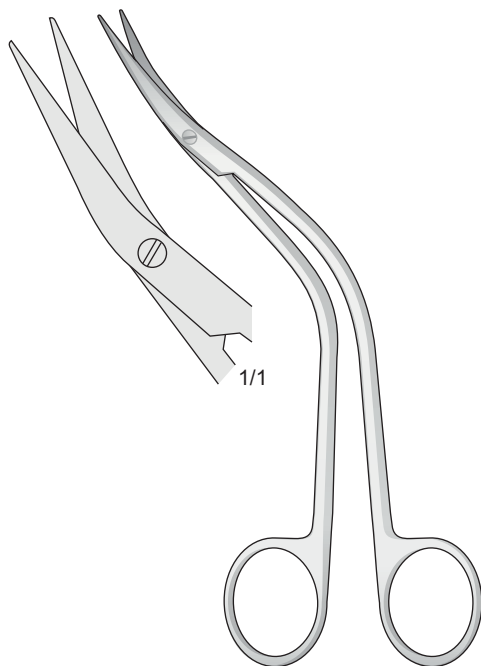


DE BAKEY (POTTS-SMITH)  
**FG-86/FG-89**  
160 mm



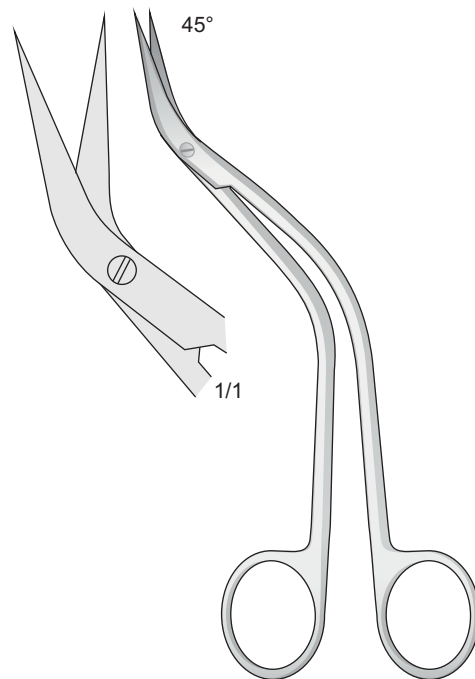
POTTS-SMITH  
**FG-70/FG-72**  
190 mm

Smussa - Blunt - Stumpf  
Mousse - Romas

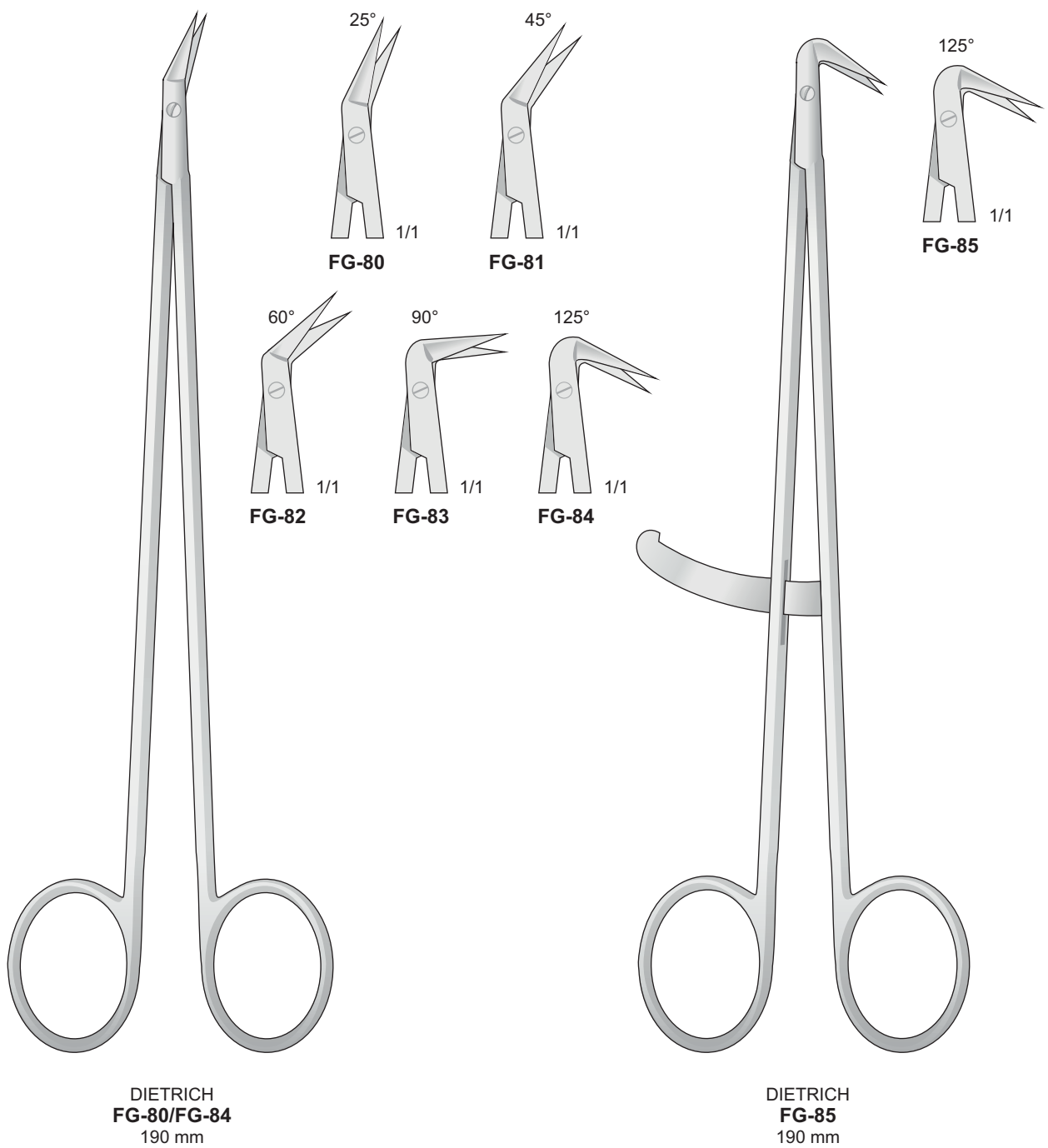


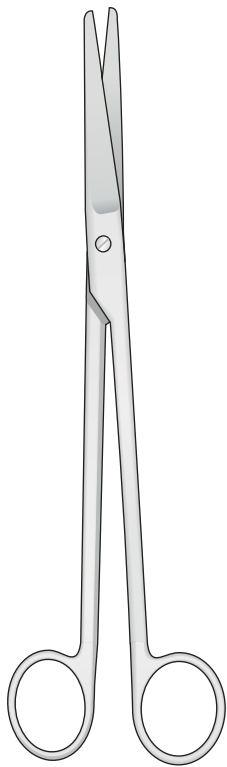
DE BAKEY  
**FG-78**  
155 mm

Acuta - Sharp - Spitz  
Pointu - Agudas

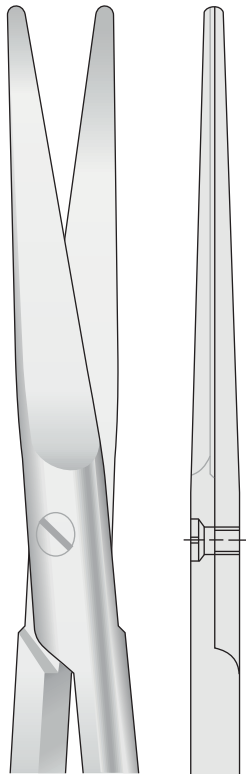


DE BAKEY  
**FG-79**  
155 mm



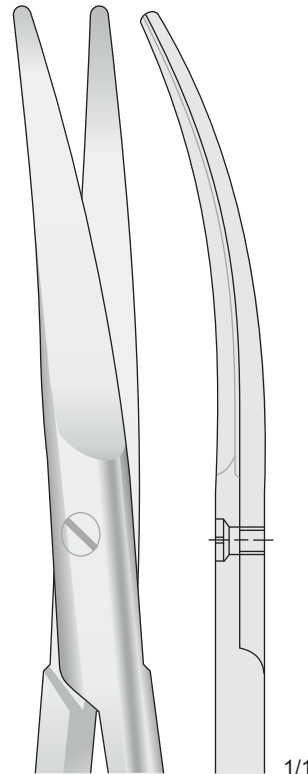


MAYO-HARRINGTON  
FM-18/FM-19  
230 mm



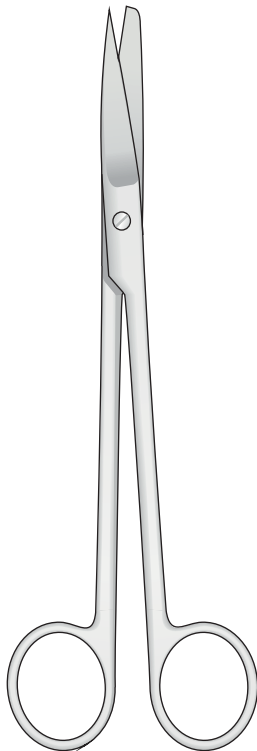
FM-18  
230 mm

1/1

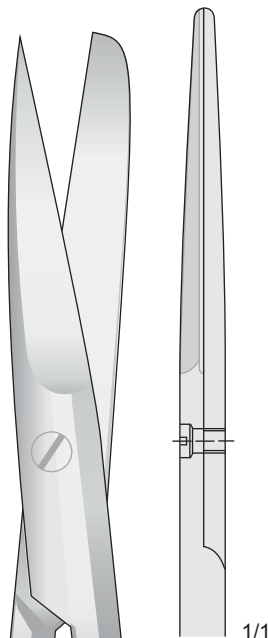


FM-19  
230 mm

1/1

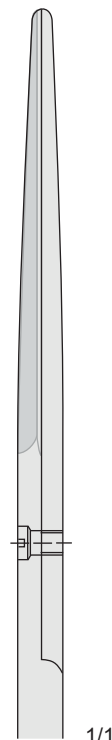


SIMS  
FM-14/FM-17



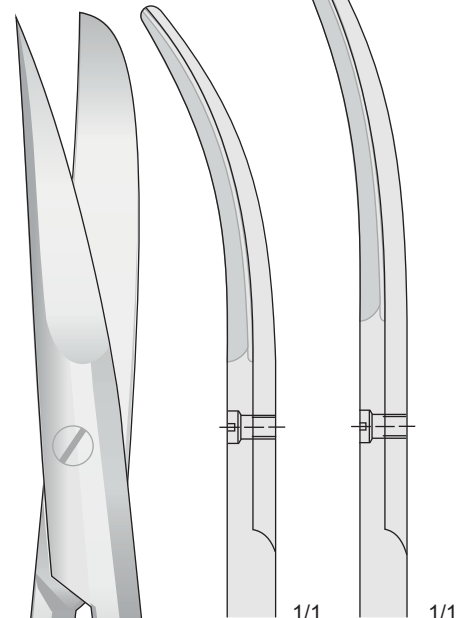
FM-14  
200 mm

1/1



FM-16  
230 mm

1/1



FM-15  
200 mm

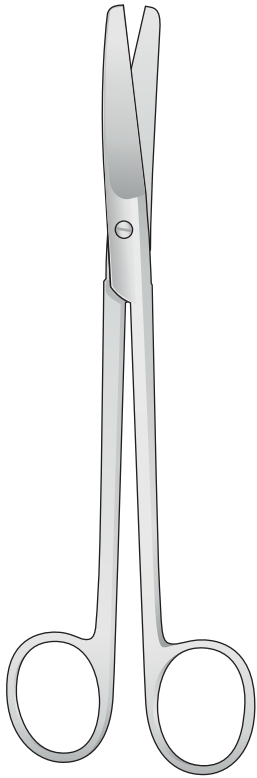
1/1

FM-17  
230 mm

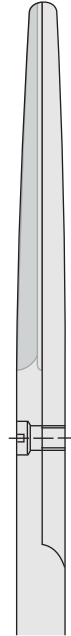
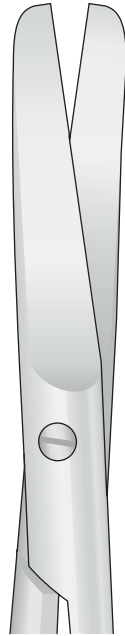
1/1



Punte smusse

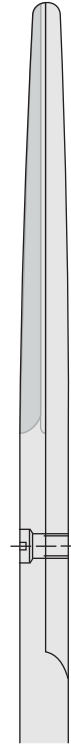


SIMS  
FM-20/FM-23



1/1

FM-20  
200 mm



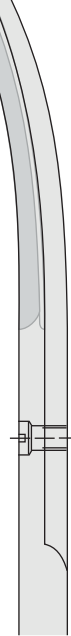
1/1

FM-22  
230 mm



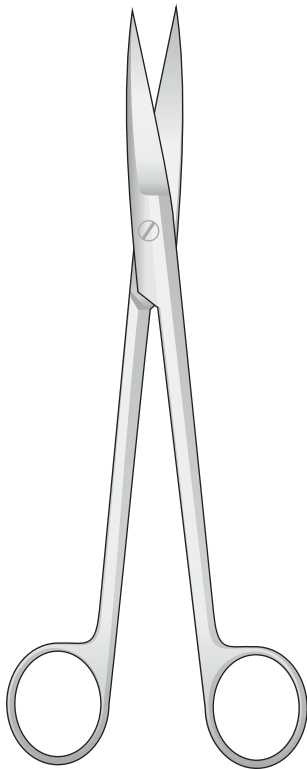
1/1

FM-21  
200 mm

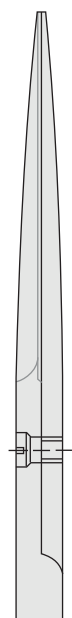


1/1

FM-23  
230 mm

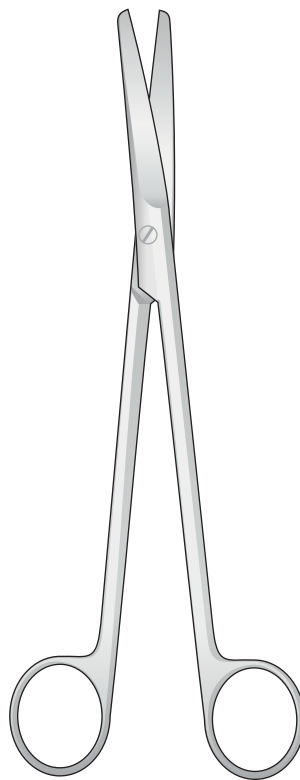


SIMS  
FG-138  
200 mm

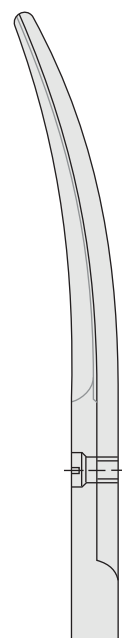
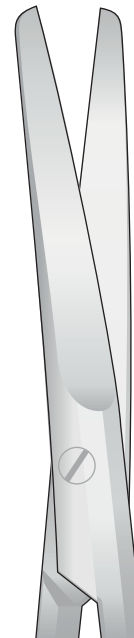


1/1

FG-138  
200 mm



SIMS  
FG-139  
210 mm

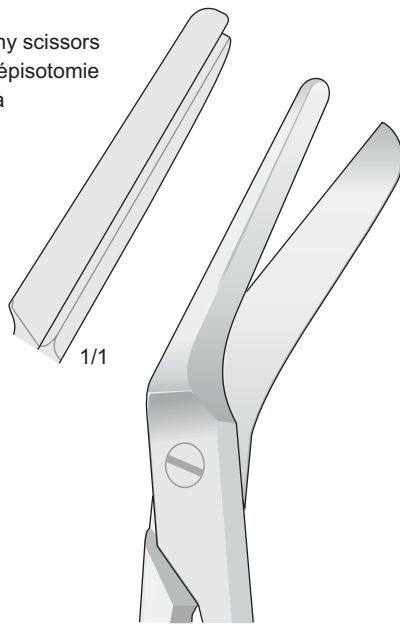
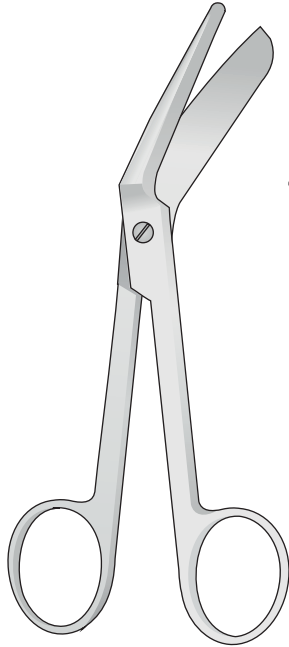


1/1

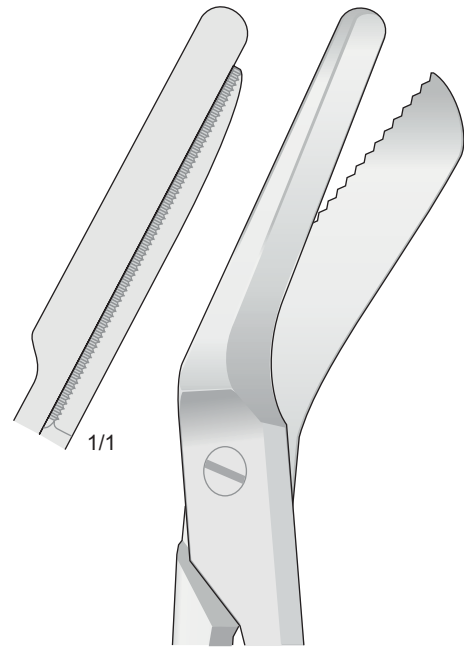
FG-139  
210 mm



Forbici per episiotomia - Episotomy scissors  
Episotomie-Scheren - Ciseaux à épisotomie  
Tijeras para episiotomia



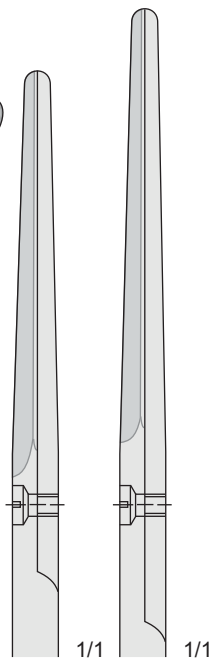
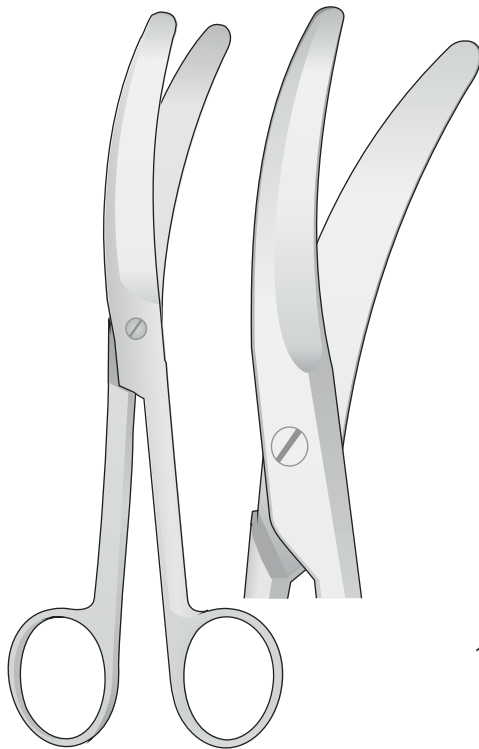
**FG-34**  
145 mm



**FG-96**  
200 mm

**BRAUN-STADLER**  
**FG-34/FG-96**

Forbici per cordone ombelicale - Umbilical cord scissors  
Nabelschnur Scheren - Ciseaux à cordon ombilical  
Tijeras umbilicales

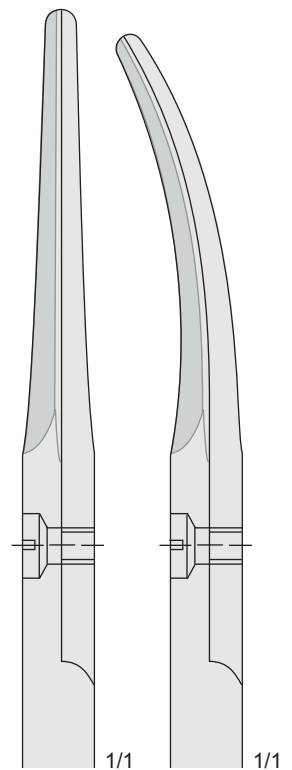


**FG-97**  
135 mm

**FG-35**  
160 mm

**FG-35/FG-97**

Forbici per cefalotomia - Cephalotomy scissors  
Kephalotomie Scheren - Ciseaux à cèphalotomie  
Tijeras para cefalotomia



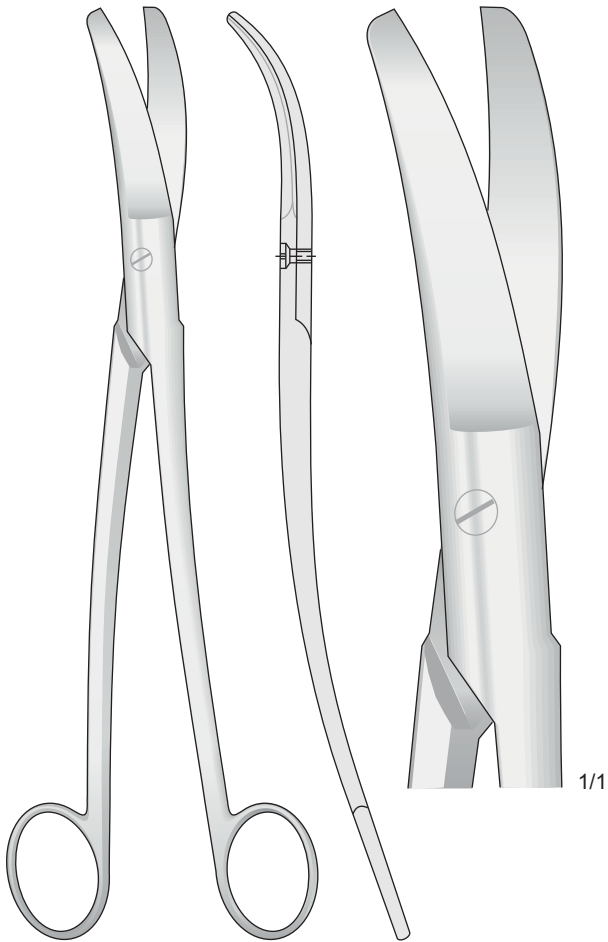
**FM-26**  
270 mm

**FM-175**  
270 mm

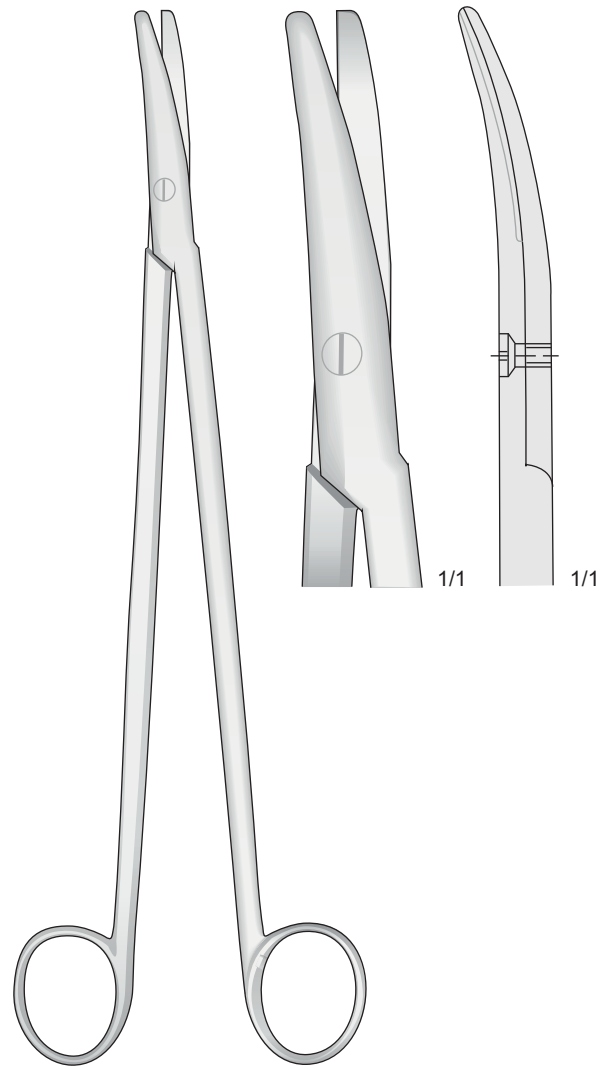
**DUBOIS**  
**FM-26/FM-175**



Forbici per utero  
Uterine scissors  
Uterusschere  
Ciseaux utérins  
Tijeras para útero



SIEBOLD  
FG-144  
245 mm



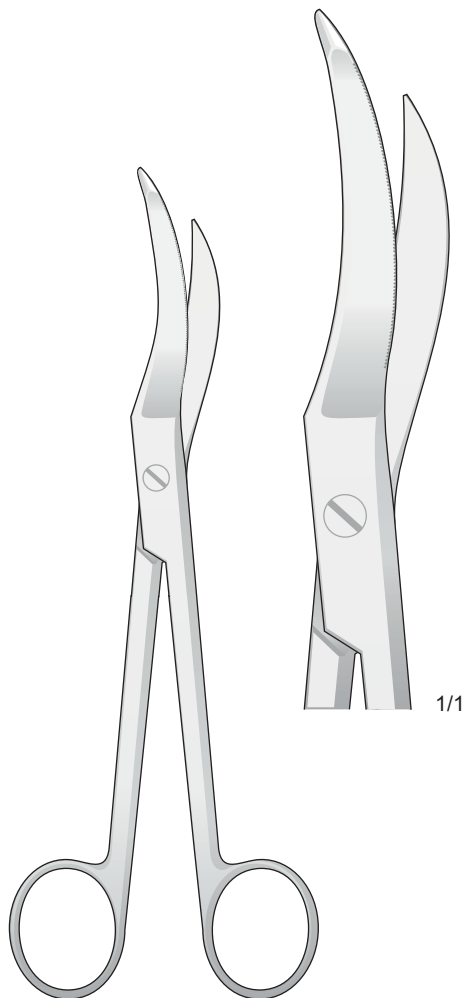
WELLER  
FG-129  
280 mm



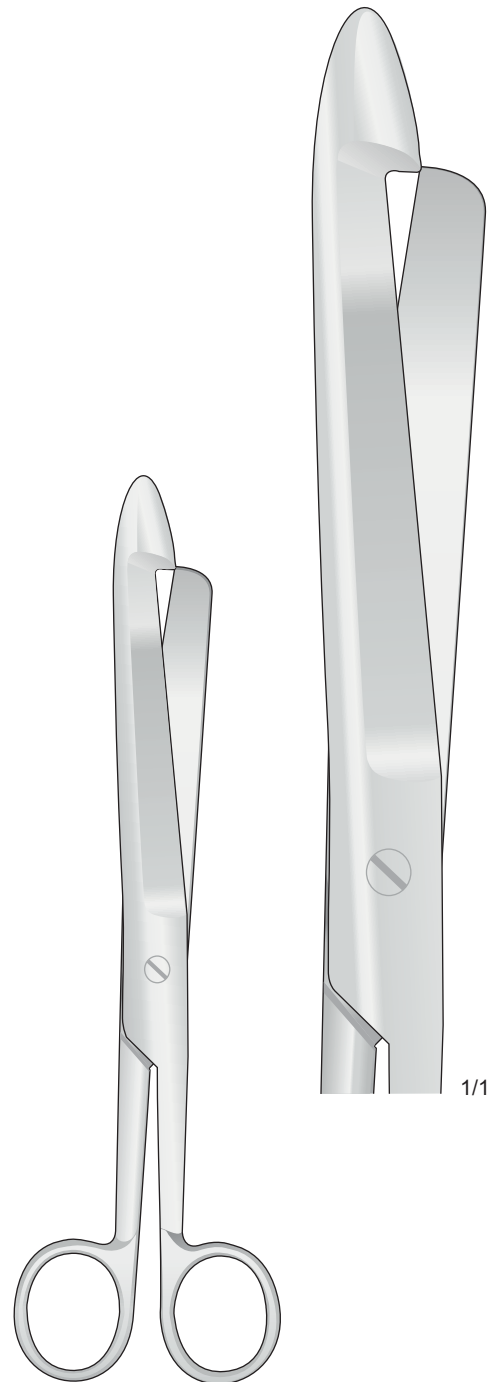


Forbici per Enterotomia  
Bowel Scissors  
Darmscheren  
Ciseaux-Entérotomes  
Enterótomos

Forbici per Episiotomia  
Episiotomy Scissors  
Episiotomie-Scheren  
Ciseaux à épisiotomie  
Tijeras para Episiotomia



WALDMANN  
FG-149  
180 mm

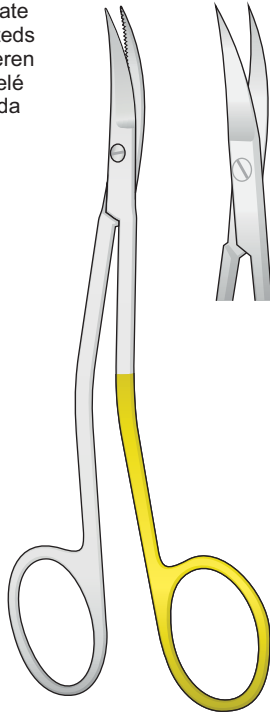


FG-180  
210 mm



Forbici "super-cut" estremamente taglienti per tessuti con riduzione del trauma - "Super-cut" scissors for gripping tissue and cutting interproximally  
 "Super-cut" scheren micro-schliff für tissue atrauma - Ciseaux "super cut" coupe les tissus en réduisant les risques de traumatisme  
 Tijeras "super cortes" para cortar tissue-atrauma

Forbici Dentellate  
 Scissors Serrateds  
 Gezahnte Scheren  
 Ciseaux Dentelé  
 Tijeras Dentada

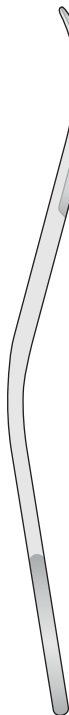


LA GRANGE  
**LG-1SC/LG-2SC**  
 115 mm



1/1

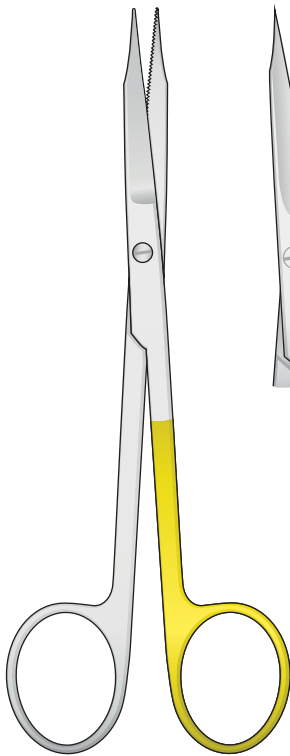
LA GRANGE  
**LG-1SC**



LA GRANGE  
**LG-2SC**

Acute  
 Sharp  
 Spitz  
 Pointu  
 Agudas

Smusse  
 Blunt  
 Stumpf  
 Mousse  
 Romas

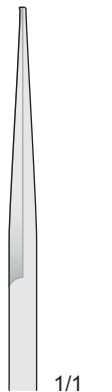


GOLDMAN-FOX  
**GFR-SC/GFC-SC**  
 135 mm



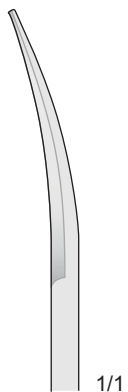
1/1

**GFR-SC**

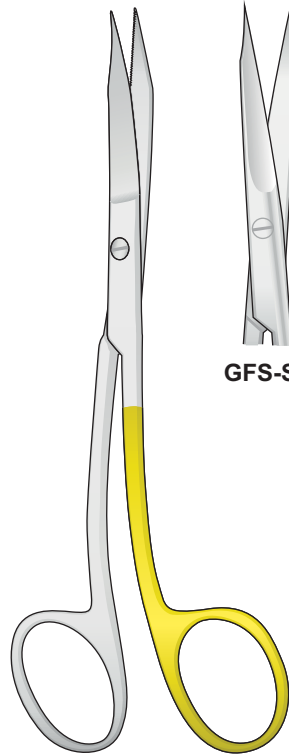


1/1

**GFC-SC**



1/1

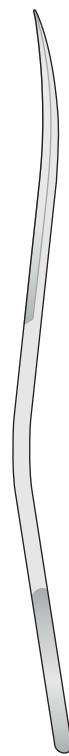


GOLDMAN-FOX S FORM  
**GFS-SC**  
 130 mm



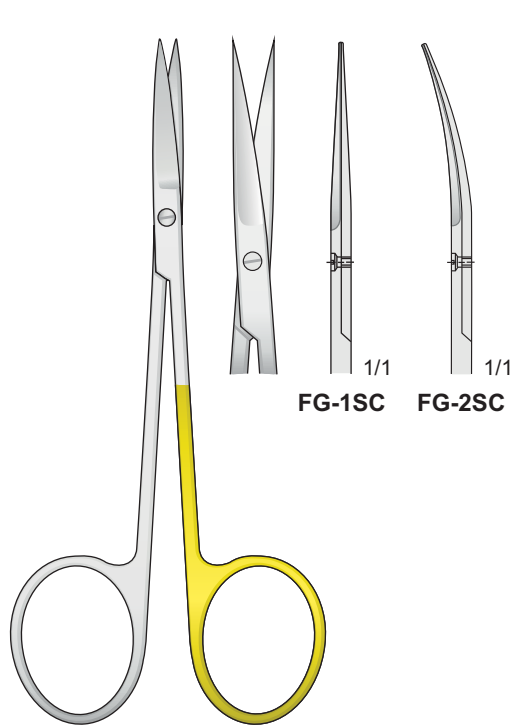
1/1

**GFS-SC**

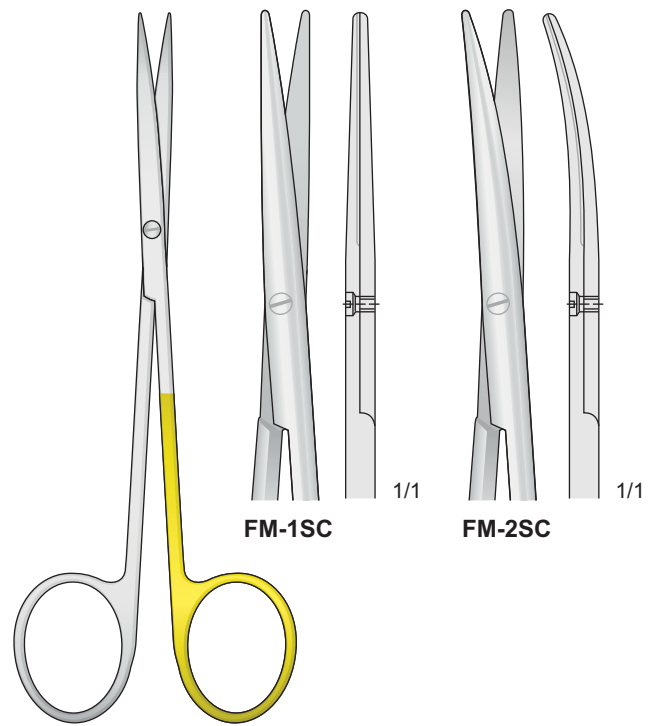




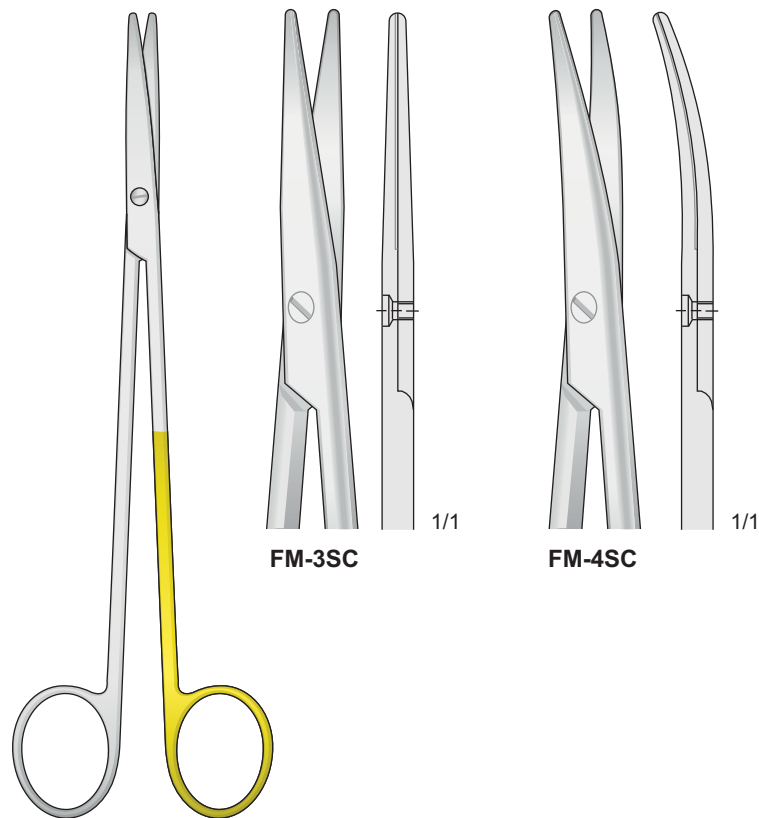
Forbici "super-cut" estremamente taglienti per tessuti con riduzione del trauma - "Super-cut" scissors for gripping tissue and cutting interproximally  
"Super-cut" scheren micro-schliff für tissue atrauma - Ciseaux "super cut" coupe les tissus en reduisant les risques de traumatisme  
Tijeras "super cortes" para cortar tissue-atrauma



IRIS  
FG-1SC/FG-2SC  
110 mm



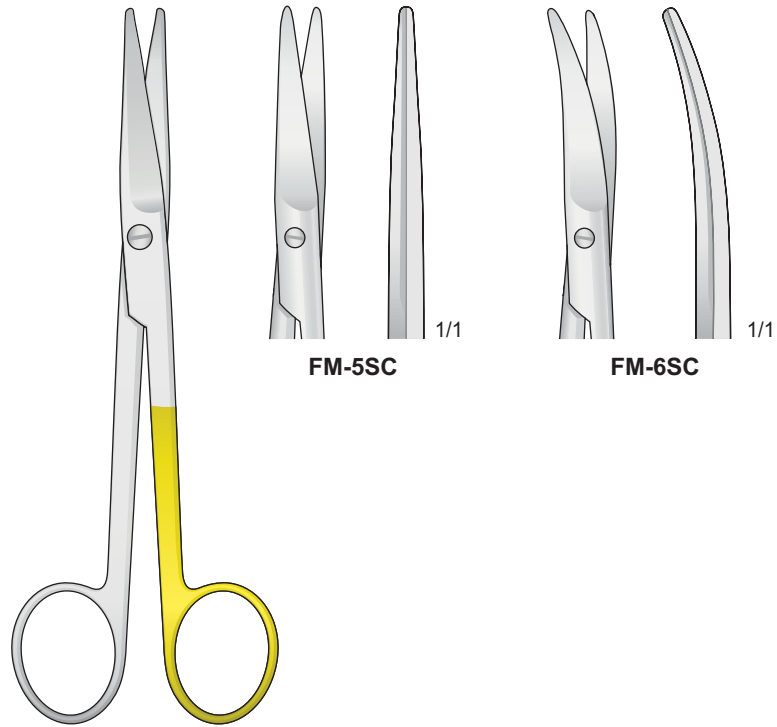
METZENBAUM  
FM-1SC/FM-2SC  
145 mm



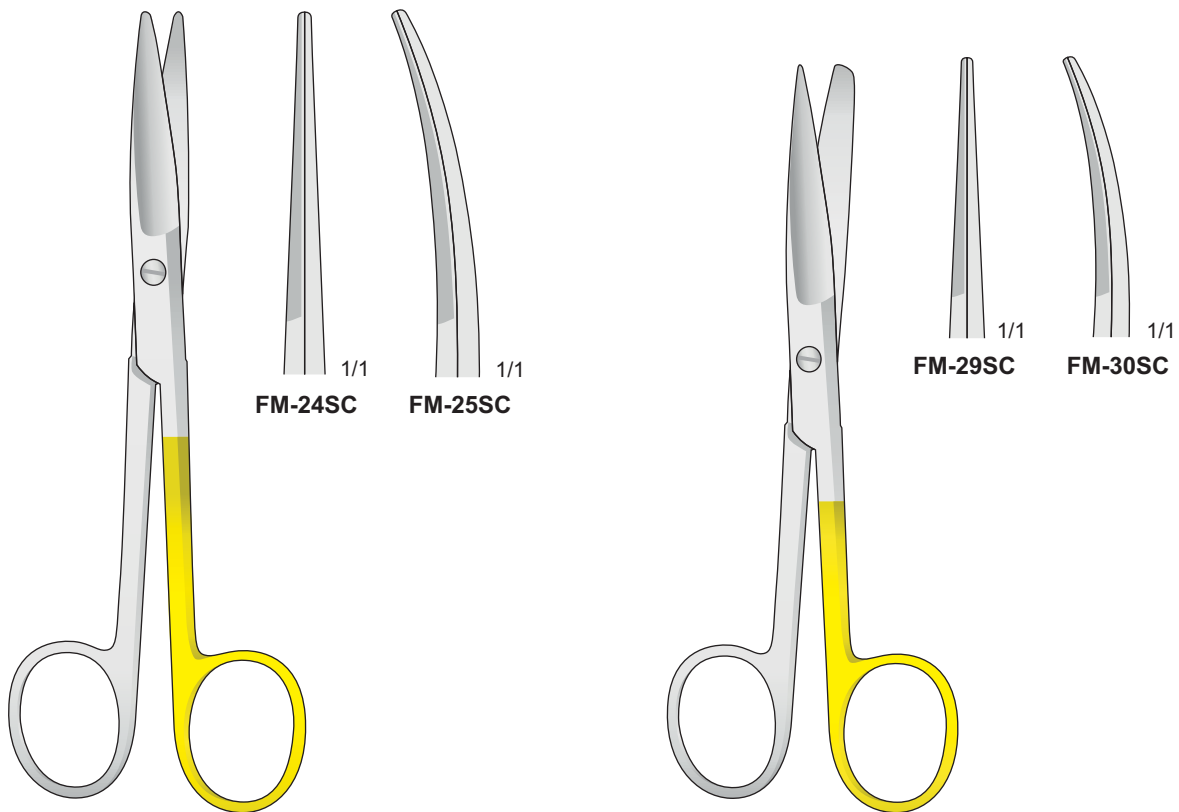
METZENBAUM  
FM-3SC/FM-4SC  
185 mm



Forbici "super-cut" estremamente taglienti per tessuti con riduzione del trauma - "Super-cut" scissors for gripping tissue and cutting interproximally  
 "Super-cut" scheren micro-schliff für tissue atrauma - Ciseaux "super cut" coupe les tissus en réduisant les risques de traumatisme  
 Tijeras "super cortes" para cortar tissue-atrauma



MAYO  
**FM-5SC/FM-6SC**  
 140 mm

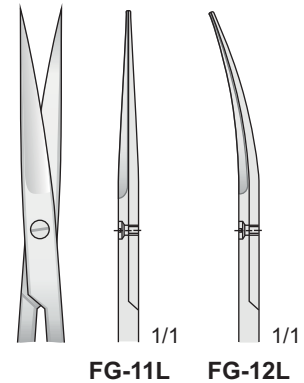
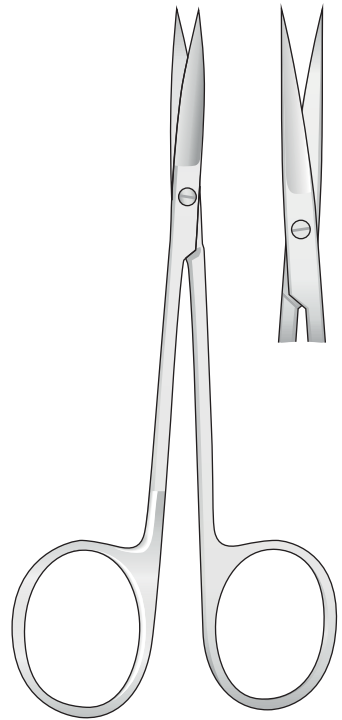


MAYO  
**FM-24SC/FM-25SC**  
 170 mm

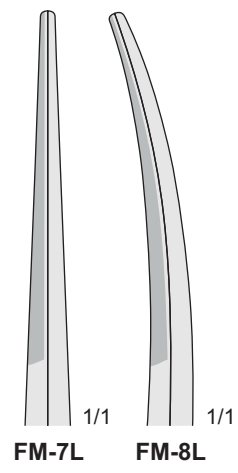
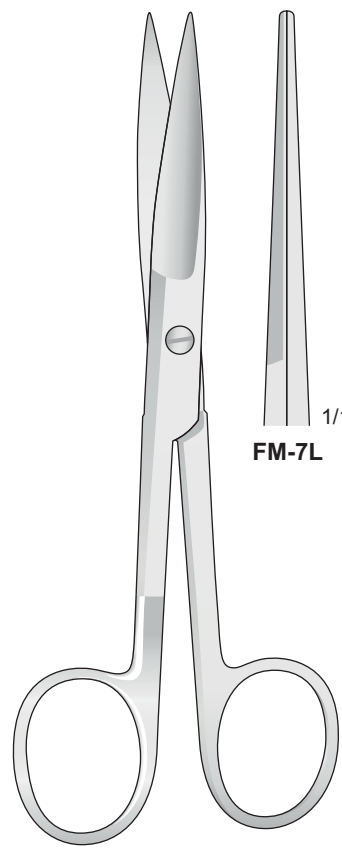
**FM-29SC/FM-30SC**  
 145 mm



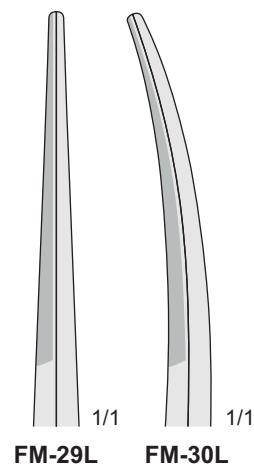
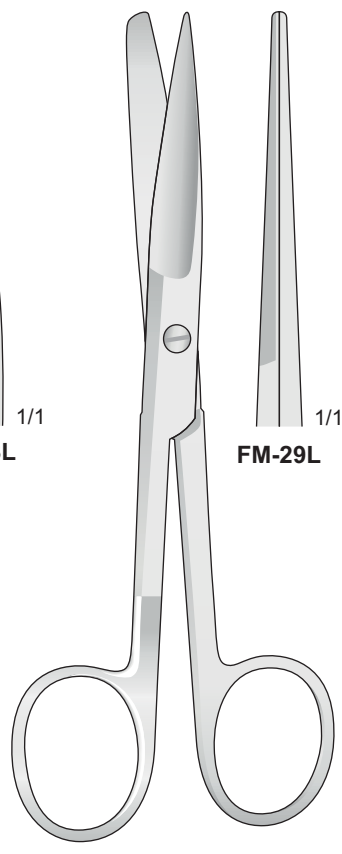
L = mancini  
 left  
 links  
 gauche  
 izquierda



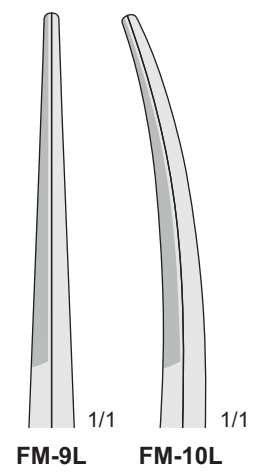
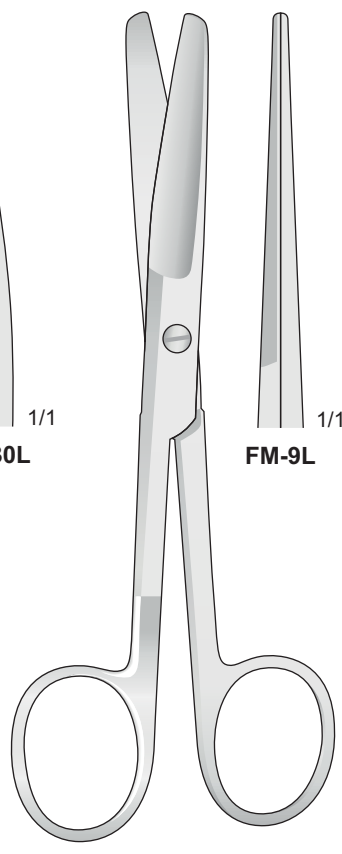
IRIS  
**FG-11L/FG-12L**  
 110 mm



**FM-7L/FM-8L**  
 145 mm



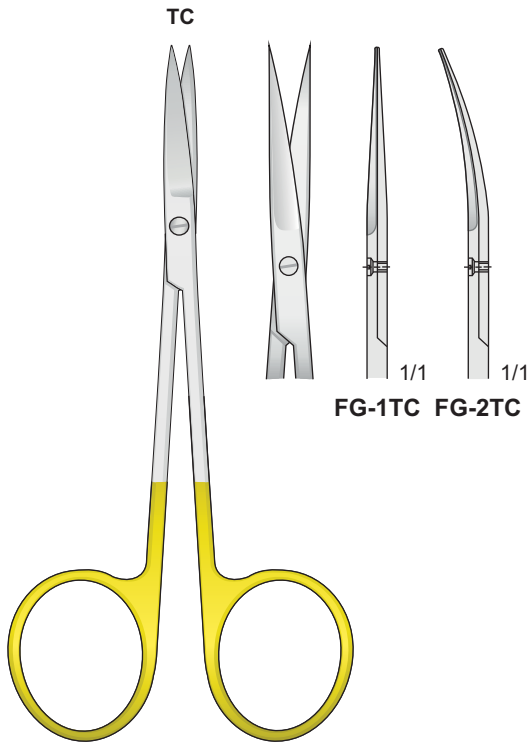
**FM-29L/FM-30L**  
 145 mm



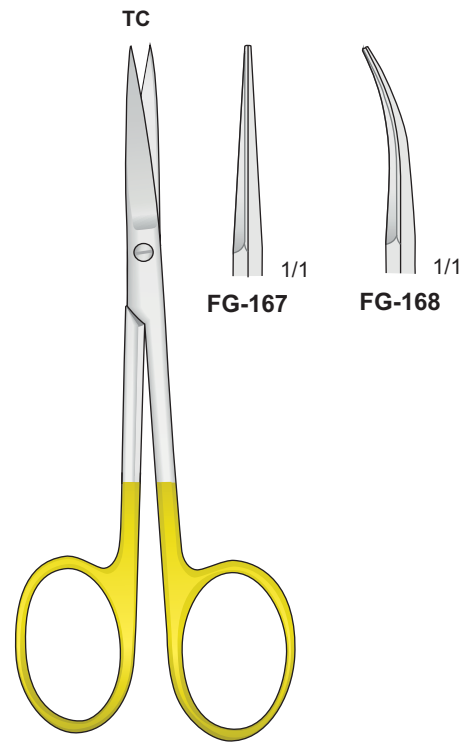
**FM-9L/FM-10L**  
 145 mm



Con punta al carburo di tungsteno - Tungsten-carbide scissors  
 Mit Hartmetalleinsätzen - Avec plaquettes en carbure de tungstène - Tijeras de tungsteno

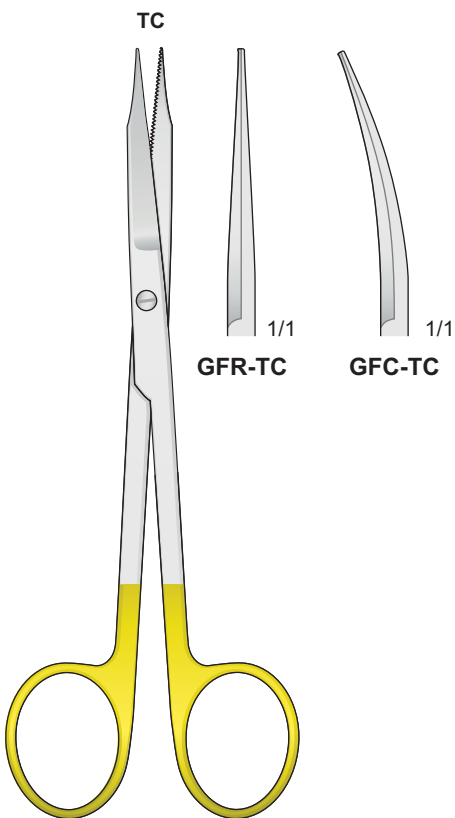


IRIS  
**FG1-TC/FG2-TC**  
 115 mm

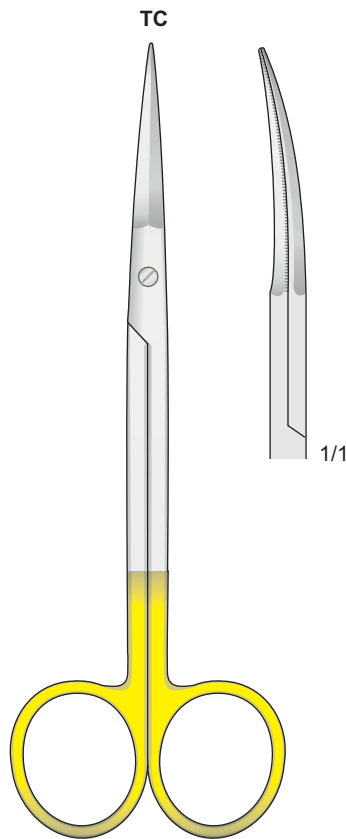


**FG-167/FG-168**  
 110 mm

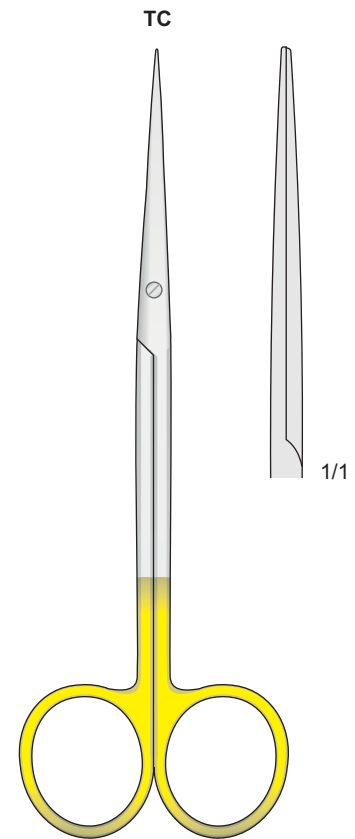
Dentellata  
 Serrated  
 Gezahnt  
 Dentée  
 Dentadas



GOLDMAN-FOX  
**GFR-TC/GFC-TC**  
 135 mm



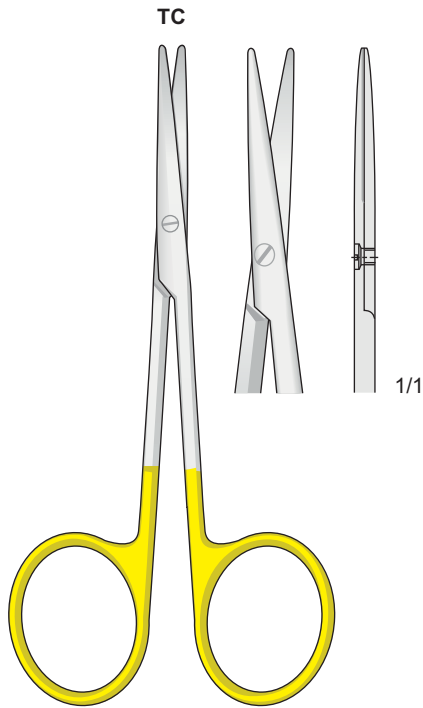
PECK-JOSEPH  
**FG-92**  
 140 mm



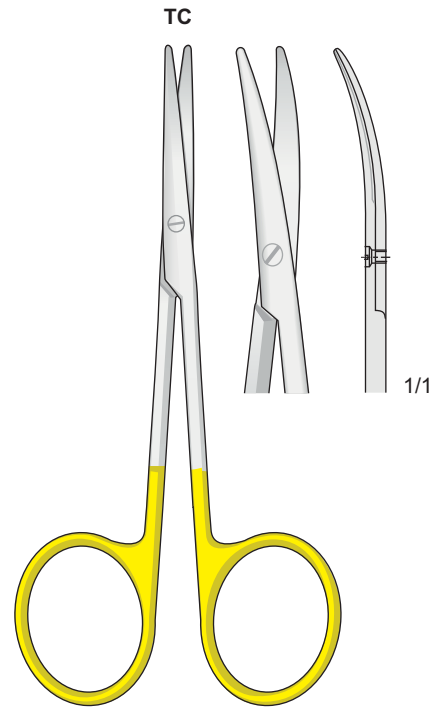
METZENBAUM-FINO  
**FM-96**  
 140 mm



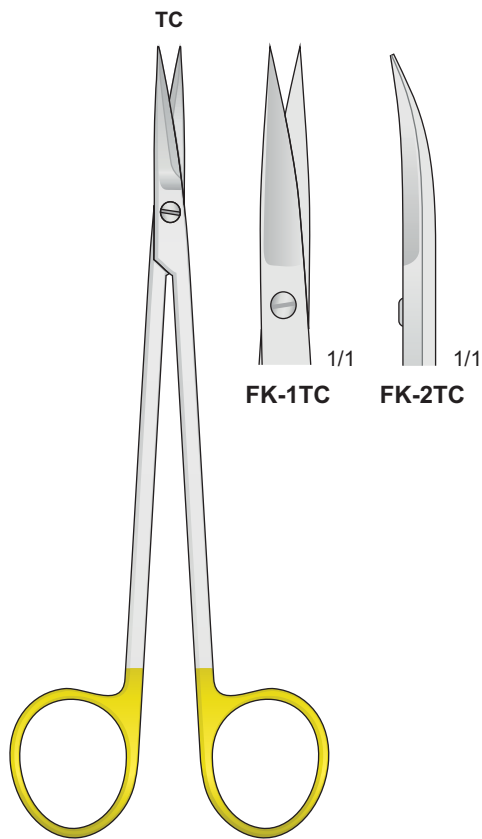
Con punta al carburo di tungsteno - Tungsten-carbide scissors  
Mit Hartmetalleinsätzen - Avec plaquettes en carbure de tungstène - Tijeras de tungsteno



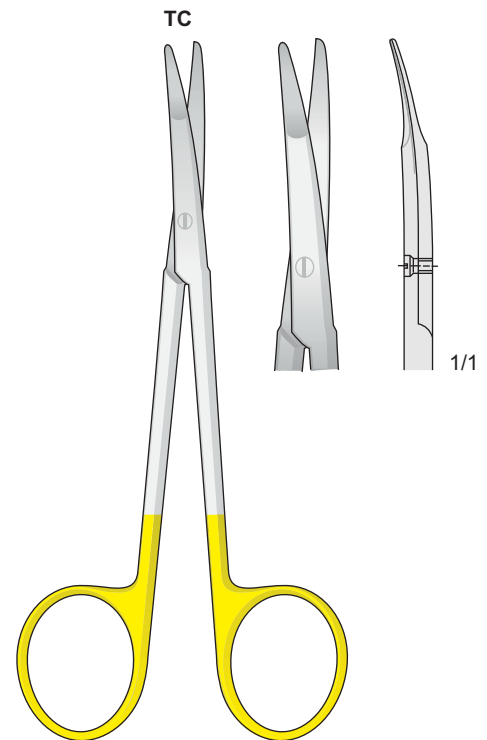
**FM-118**  
115 mm



**FM-119**  
115 mm



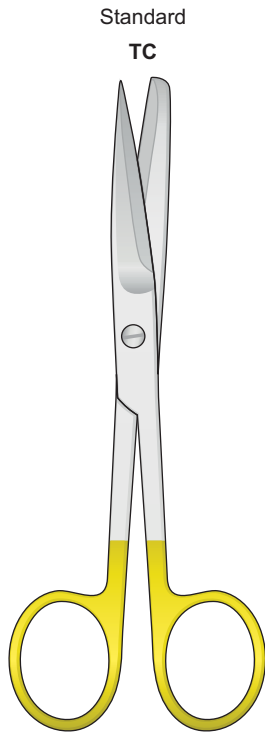
**KELLY**  
**FK-1TC/FK-2TC**  
160 mm



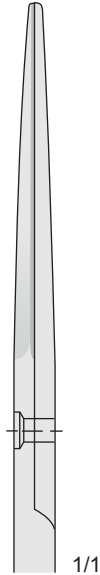
**KILNER (RAGNELL)**  
**FM-350**  
125 mm



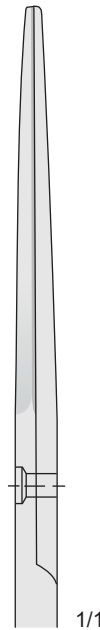
Con punta al carburo di tungsteno - Tungsten-carbide scissors  
Mit Hartmetalleinsätzen - Avec plaquettes en carbure de tungstène - Tijeras de tungsteno



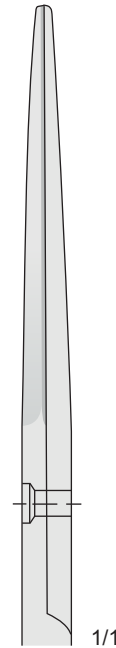
FM-50/FM-53



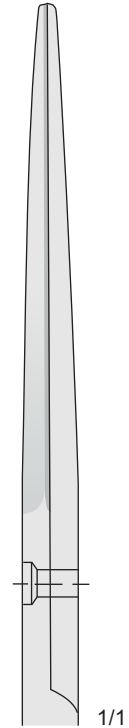
FM-50  
130 mm



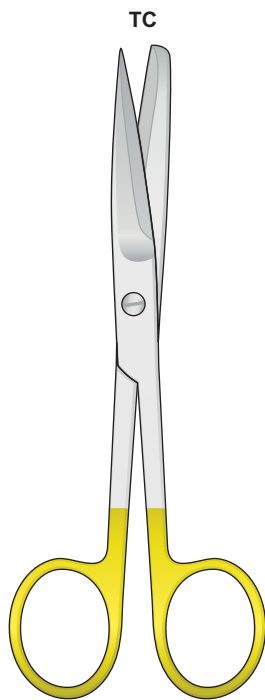
FM-51  
145 mm



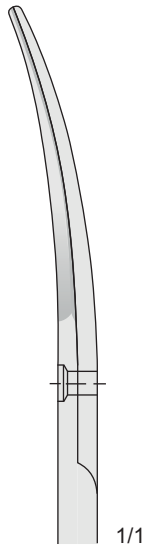
FM-52  
165 mm



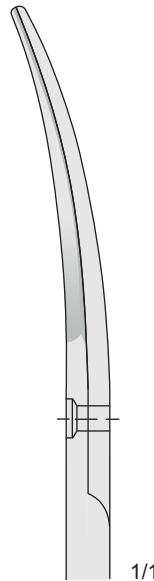
FM-53  
185 mm



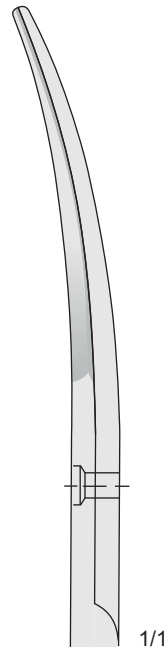
FM-148/FM-150



FM-148  
130 mm



FM-149  
145 mm



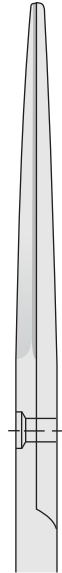
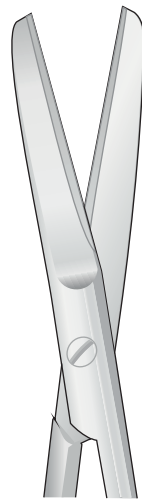
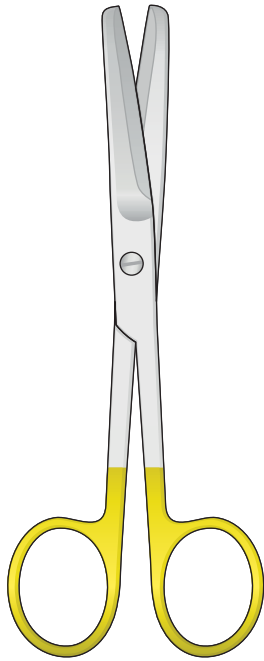
FM-150  
165 mm



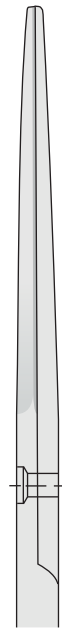


Con punta al carburo di tungsteno - Tungsten-carbide scissors  
Mit Hartmetalleinsätzen - Avec plaquettes en carbure de tungstène - Tijeras de tungsteno

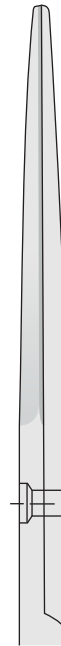
Standard  
TC



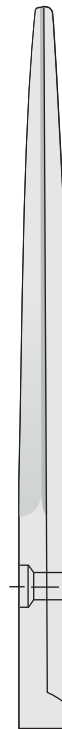
**FM-54**  
130 mm



**FM-55**  
145 mm



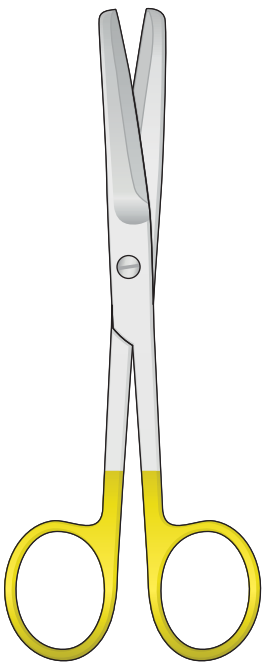
**FM-56**  
165 mm



**FM-57**  
185 mm

**FM-54/FM-57**

TC



**FM-151**  
130 mm



**FM-152**  
145 mm



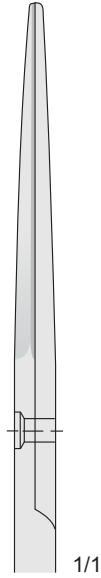
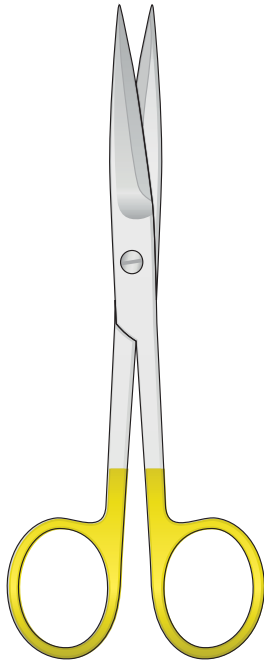
**FM-153**  
165 mm

**FM-151/FM-153**

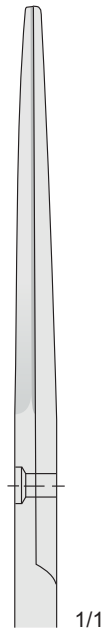


Con punta al carburo di tungsteno - Tungsten-carbide scissors  
Mit Hartmetalleinsätzen - Avec plaquettes en carbure de tungstène - Tijeras de tungsteno

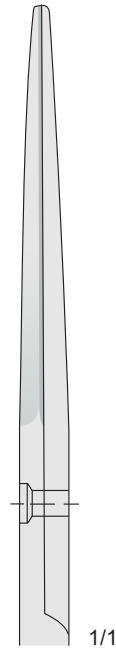
Standard  
TC



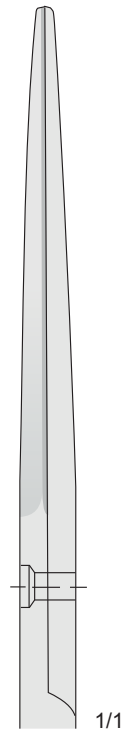
**FM-58**  
130 mm



**FM-59**  
145 mm



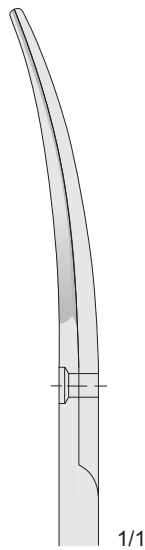
**FM-60**  
165 mm



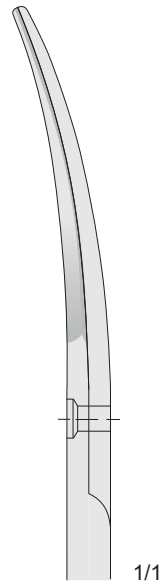
**FM-61**  
185 mm

**FM-58/FM-61**

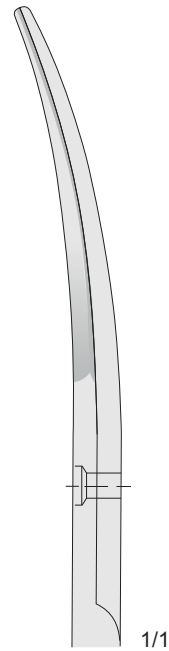
TC



**FM-145**  
130 mm



**FM-146**  
145 mm



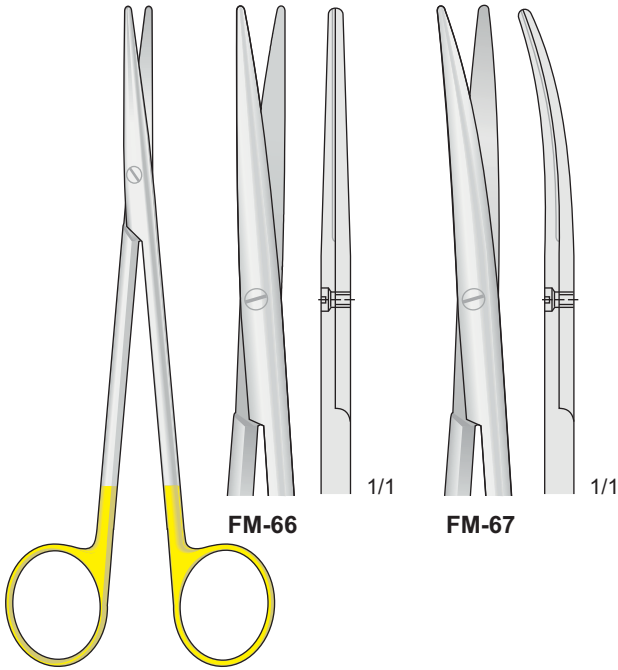
**FM-147**  
165 mm

**FM-145/FM-147**



Con punta al carburo di tungsteno - Tungsten-carbide scissors  
Mit Hartmetalleinsätzen - Avec plaquettes en carbure de tungstène - Tijeras de tungsteno

TC

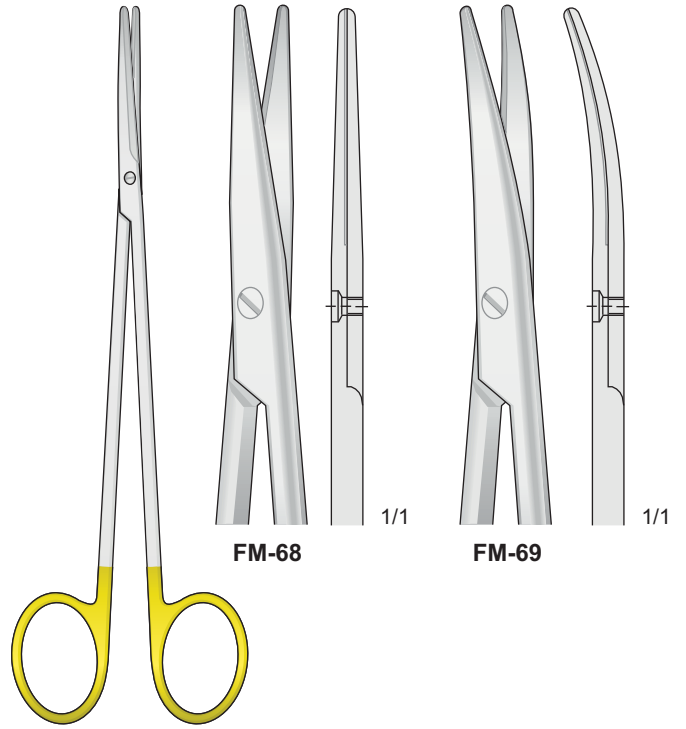


FM-66

FM-67

METZENBAUM  
FM-66/FM-67  
145 mm

TC

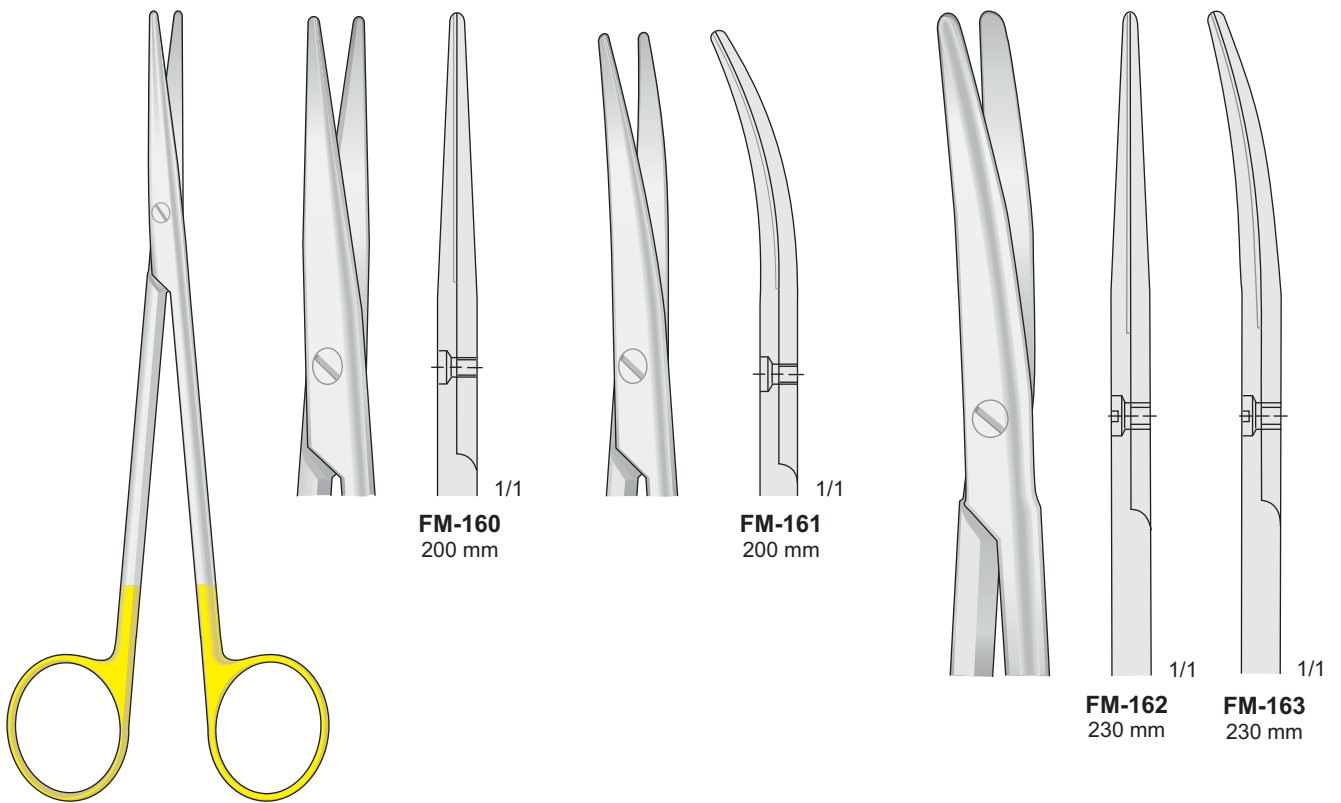


FM-68

FM-69

METZENBAUM  
FM-68/FM-69  
185 mm

TC



FM-160  
200 mm

FM-161  
200 mm

FM-162  
230 mm

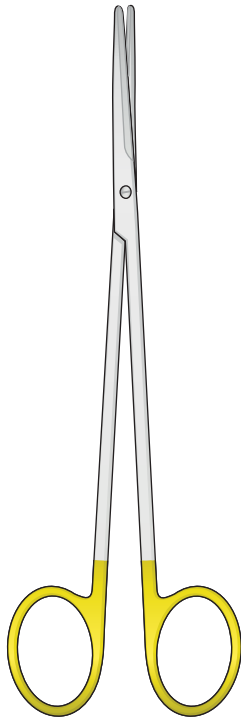
FM-163  
230 mm

METZENBAUM  
FM-160/FM-163

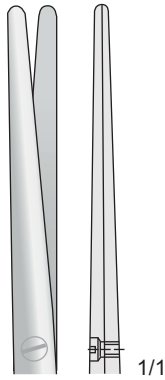


Con punta al carburo di tungsteno - Tungsten-carbide scissors  
Mit Hartmetalleinsätzen - Avec plaquettes en carbure de tungstène - Tijeras de tungsteno

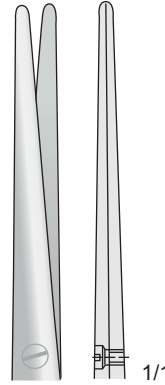
TC



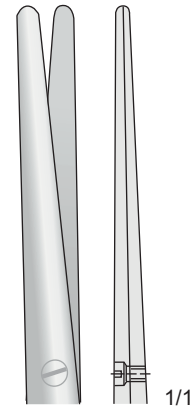
METZENBAUM-FINO  
FM-201/FM-205



**FM-201**  
140 mm

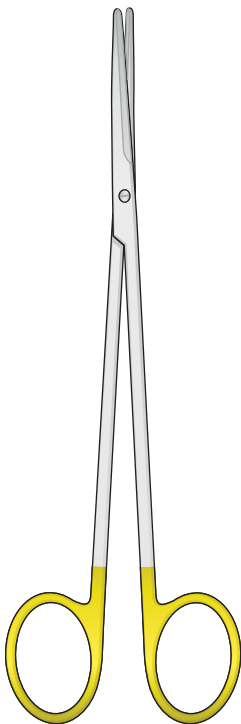


**FM-203**  
180 mm

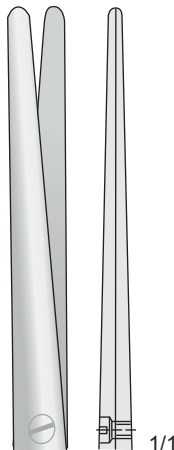


**FM-205**  
200 mm

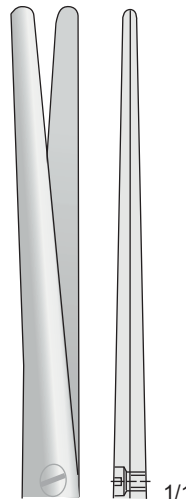
TC



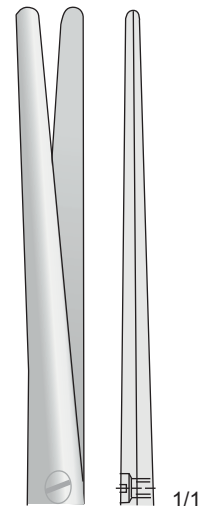
METZENBAUM-FINO  
FM-207/FM-211



**FM-207**  
230 mm



**FM-209**  
250 mm

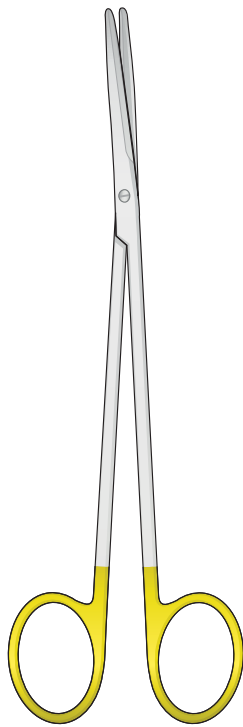


**FM-211**  
280 mm

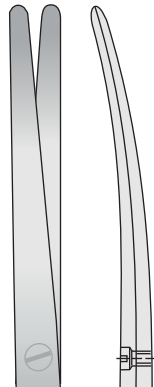


Con punta al carburo di tungsteno - Tungsten-carbide scissors  
Mit Hartmetalleinsätzen - Avec plaquettes en carbure de tungstène - Tijeras de tungsteno

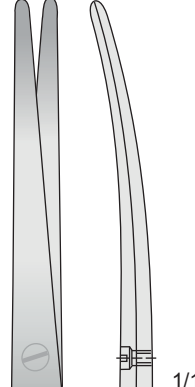
TC



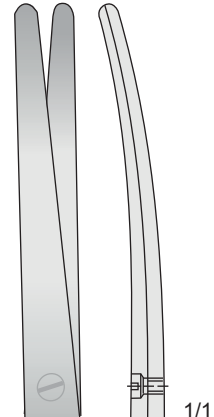
METZENBAUM-FINO  
FM-202/FM-206



FM-202  
140 mm

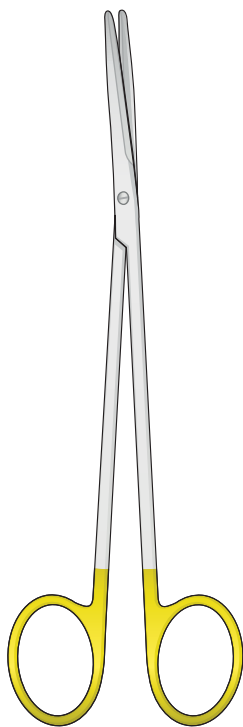


FM-204  
180 mm

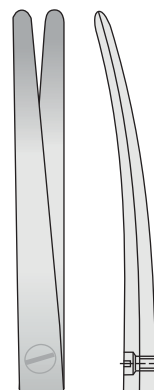


FM-206  
200 mm

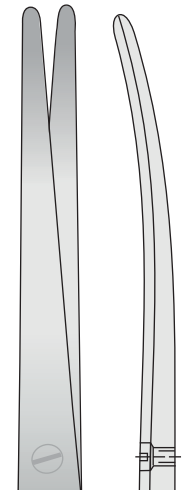
TC



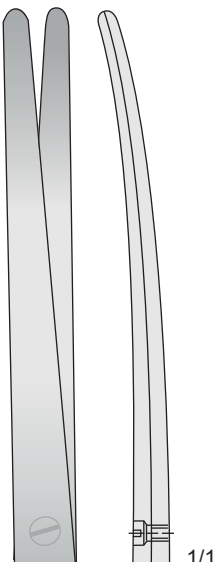
METZENBAUM-FINO  
FM-208/FM-212



FM-208  
230 mm



FM-210  
250 mm

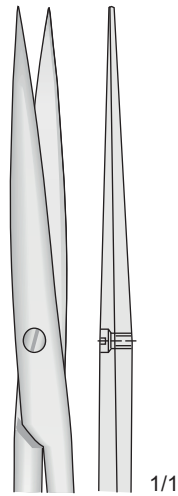
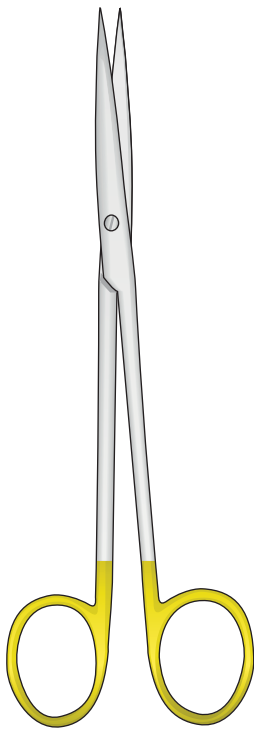


FM-212  
280 mm

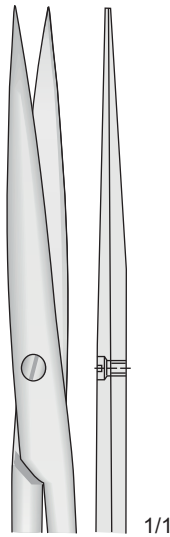


Con punta al carburo di tungsteno - Tungsten-carbide scissors  
 Mit Hartmetalleinsätzen - Avec plaquettes en carbure de tungstène - Tijeras de tungsteno

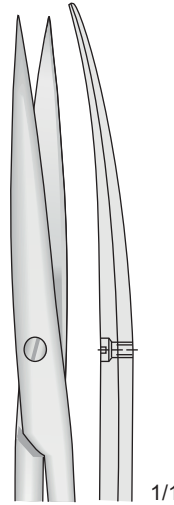
TC



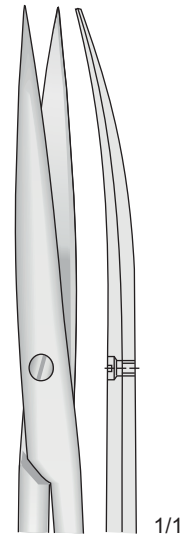
**FM-96**  
140 mm



**FM-97**  
180 mm



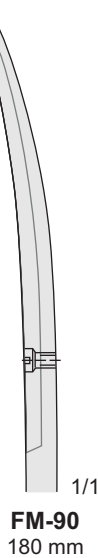
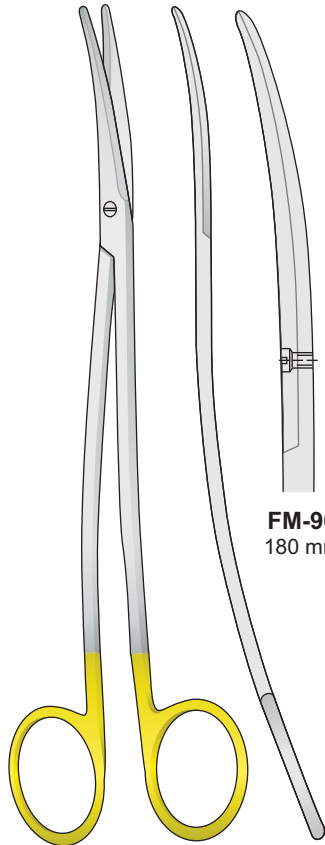
**FM-98**  
140 mm



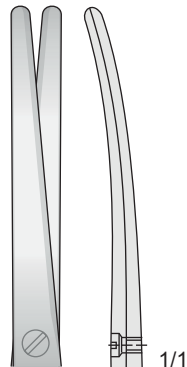
**FM-99**  
180 mm

METZENBAUM-FINO  
**FM-96/FM-99**

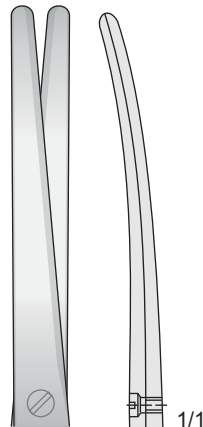
TC



**FM-90**  
180 mm



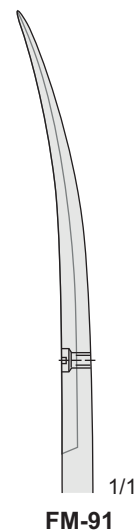
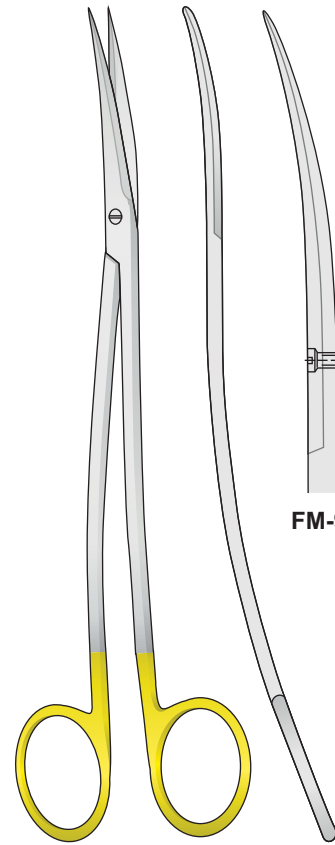
**FM-92**  
200 mm



**FM-94**  
230 mm

METZENBAUM-FINO  
**FM-90/FM-94**

TC



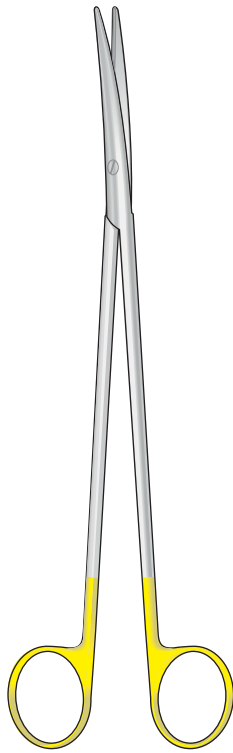
**FM-91**

METZENBAUM-FINO  
**FM-91**  
180 mm

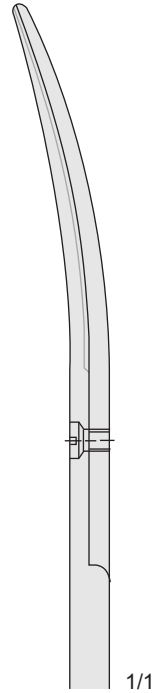
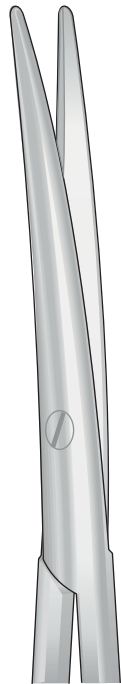


Con punta al carburo di tungsteno - Tungsten-carbide scissors  
Mit Hartmetalleinsätzen - Avec plaquettes en carbure de tungstène  
Tijeras de tungsteno

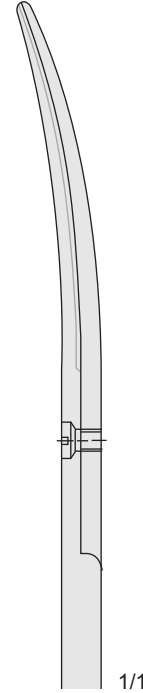
TC



NELSON-METZENBAUM  
FM-154/FM-155

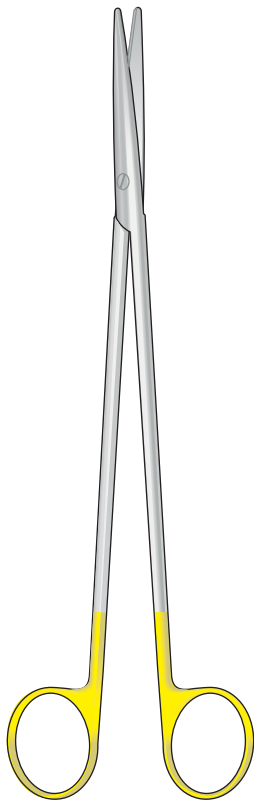


FM-154  
260 mm

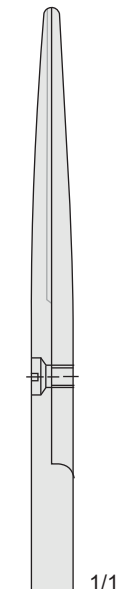


FM-155  
280 mm

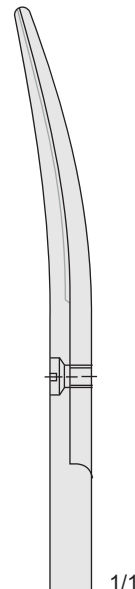
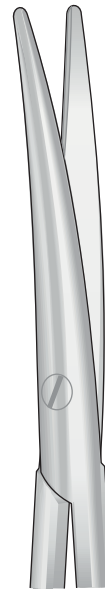
TC



NELSON-METZENBAUM  
FM-156/FM-159



FM-156  
230 mm



FM-157  
230 mm



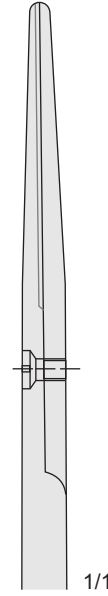
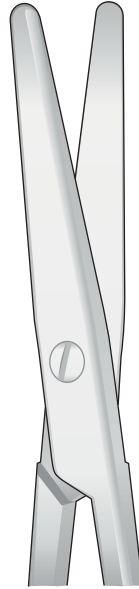
FM-159  
300 mm



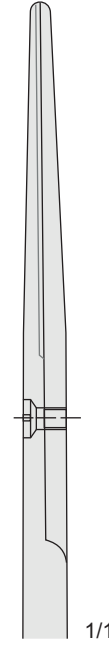
TC    Con punta al carburo di tungsteno - Tungsten-carbide scissors  
Mit Hartmetalleinsätzen - Avec plaquettes en carbure de tungstène - Tijeras de tungsteno



MAYO-STILLE  
FM-130/FM-131

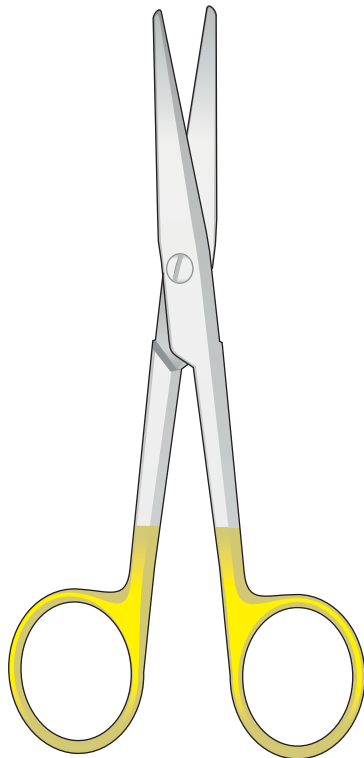


FM-130  
140 mm

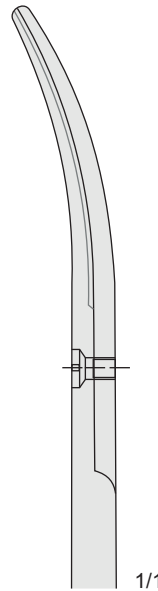
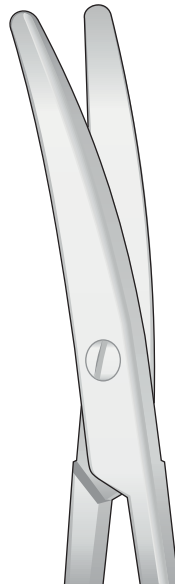


FM-131  
170 mm

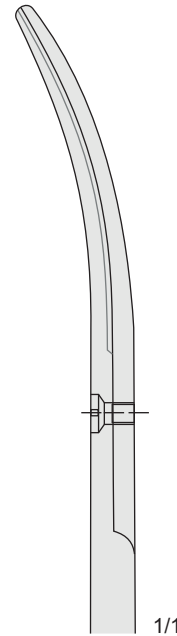
TC



MAYO-STILLE  
FM-132/FM-133



FM-132  
140 mm



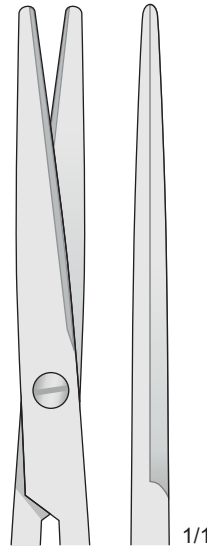
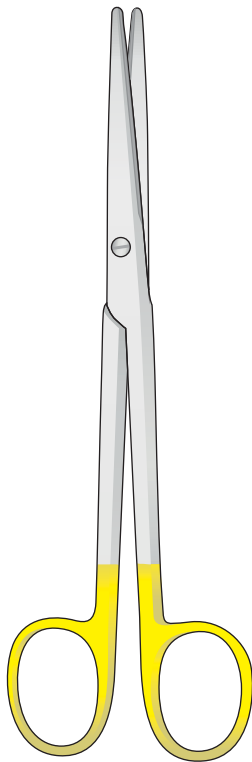
FM-133  
170 mm



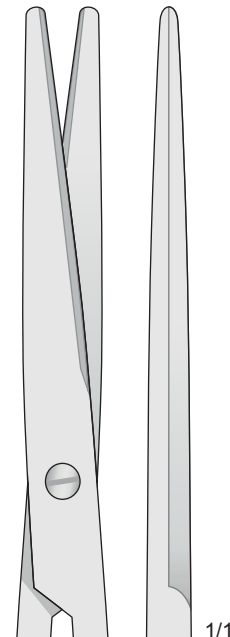


TC

Con punta al carburo di tungsteno - Tungsten-carbide scissors  
Mit Hartmetalleinsätzen - Avec plaquettes en carbure de tungstène - Tijeras de tungsteno



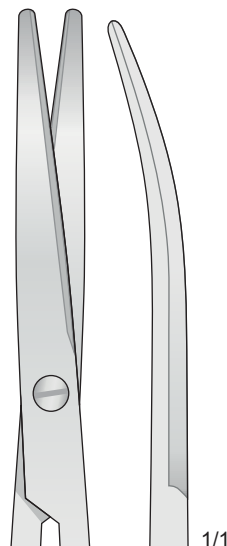
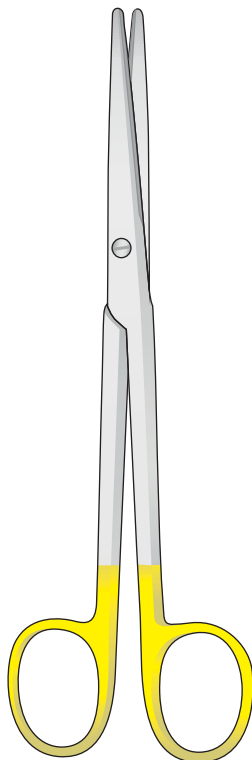
**FM-134**  
160 mm



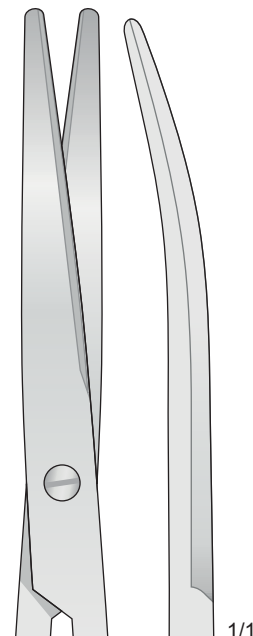
**FM-135**  
210 mm

LEXER  
**FM-134/FM-135**

TC



**FM-136**  
160 mm

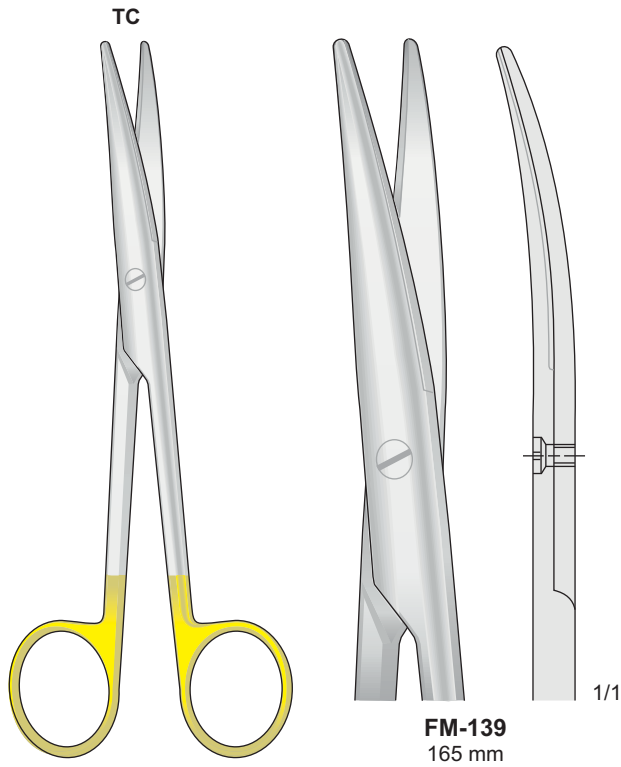


**FM-137**  
210 mm

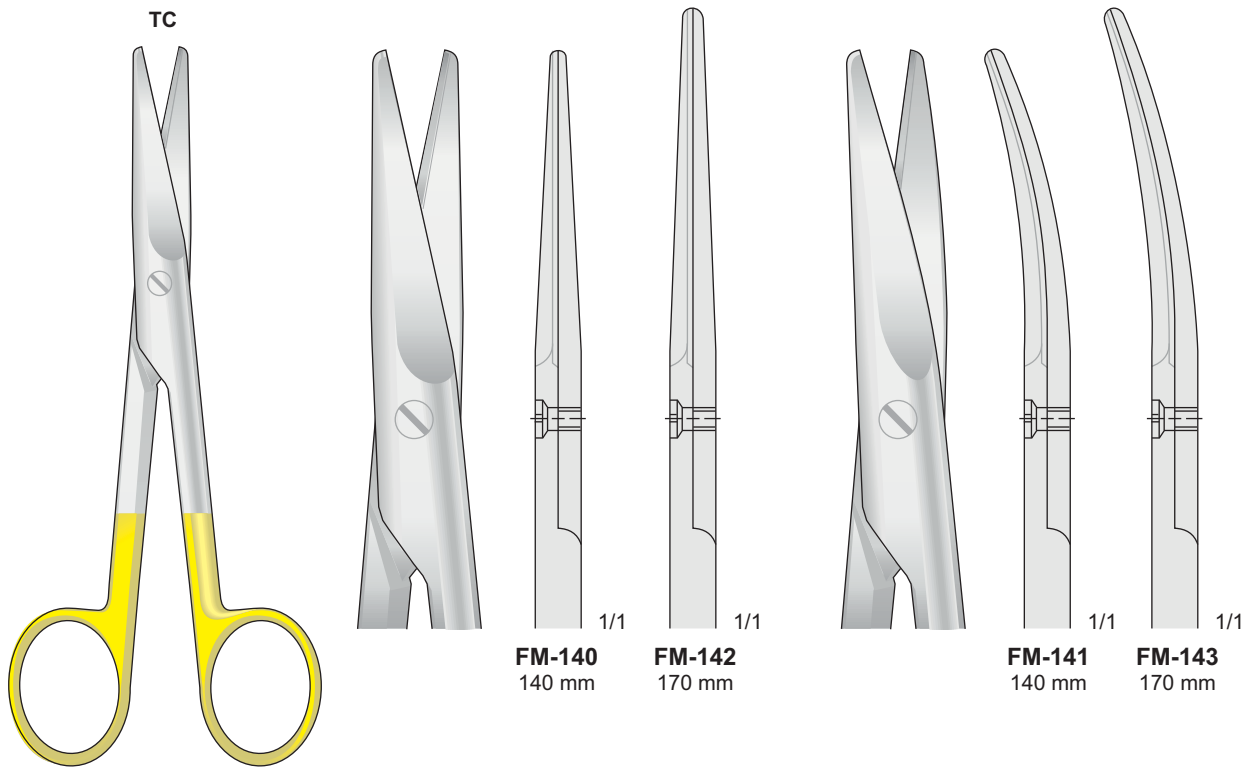
LEXER  
**FM-136/FM-137**



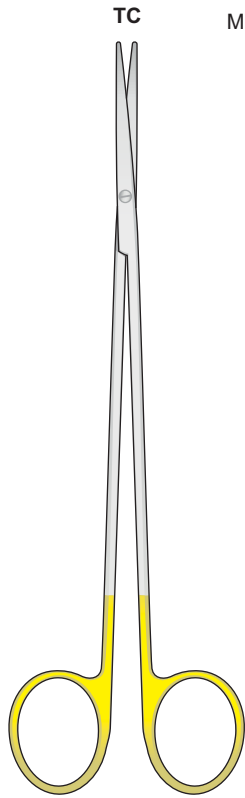
Con punta al carburo di tungsteno - Tungsten-carbide scissors  
 Mit Hartmetalleinsätzen - Avec plaquettes en carbure de tungstène - Tijeras de tungsteno



MAYO-LEXER  
**FM-139**  
165 mm

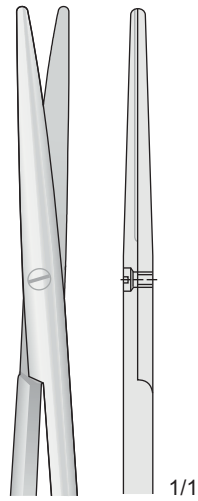


MAYO  
**FM-140/FM-143**

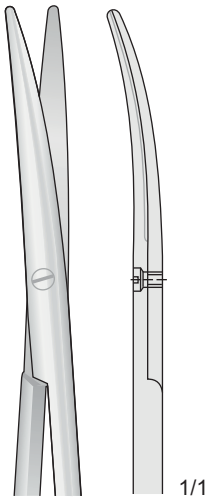


TOENNIS-ADSON  
**FG-63/FG-64**  
180 mm

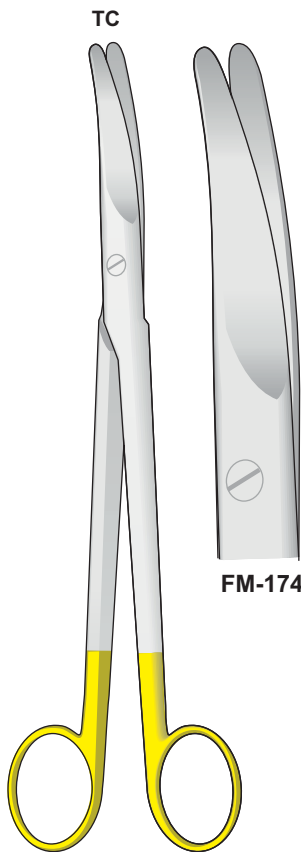
TC  
Con punta al carburo di tungsteno - Tungsten-carbide scissors  
Mit Hartmetalleinsätzen - Avec plaquettes en carbure de tungstène - Tijeras de tungsteno



**FG-63**



**FG-64**

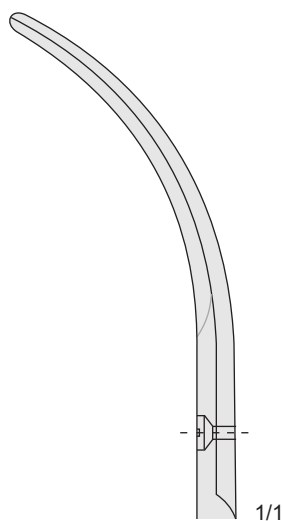


PARAMETRIUM-PARAMETRIO  
**FM-174**  
225 mm

TC



**FM-174**



1/1



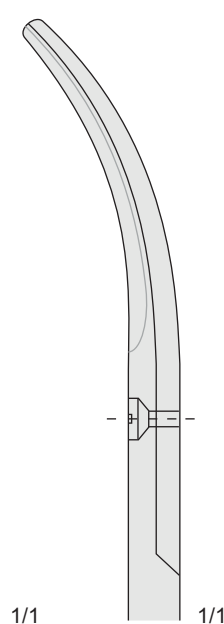
**FM-193**  
250 mm

TC

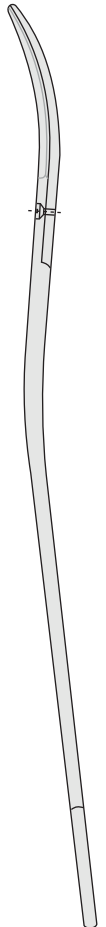
Forbice per isterectomia - Hysterectomy Scissors  
Hysterectomie Scheren - Ciseaux à Hystérectomie  
Tijera para Histerectomia



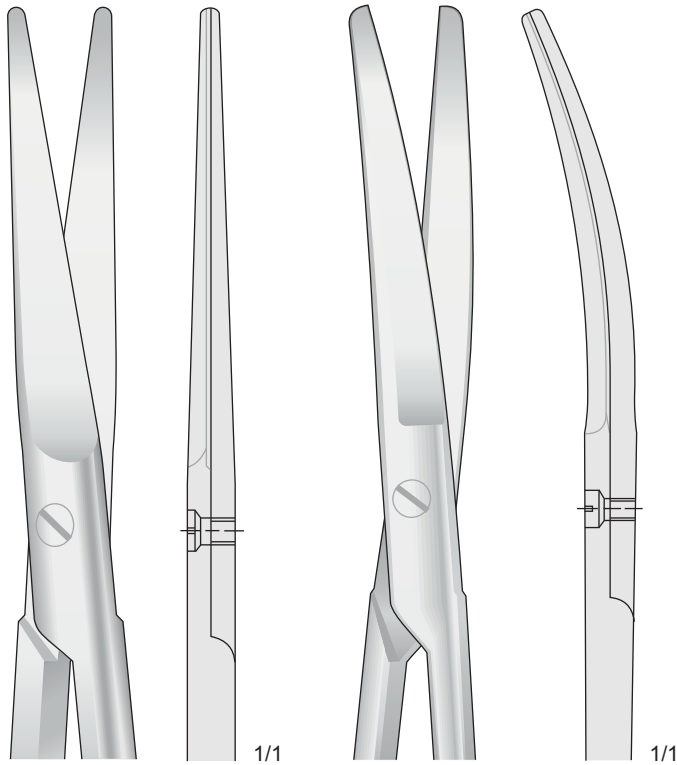
**FM-193**



1/1



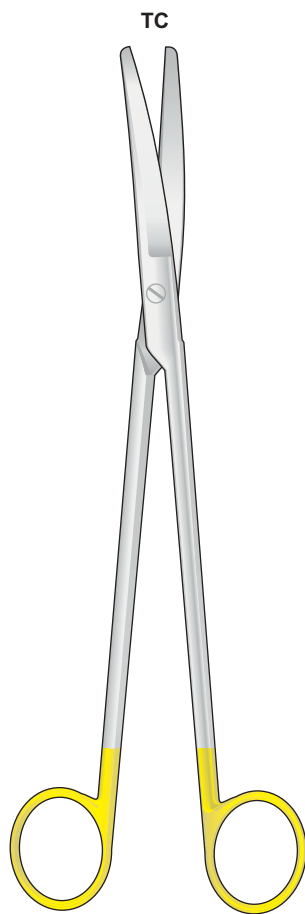
1/1



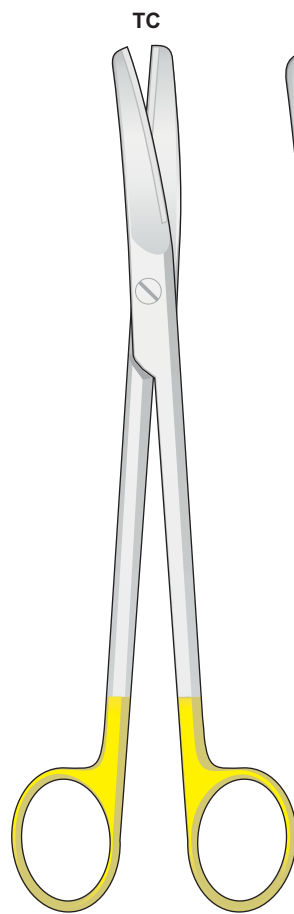
FM-190

FM-194

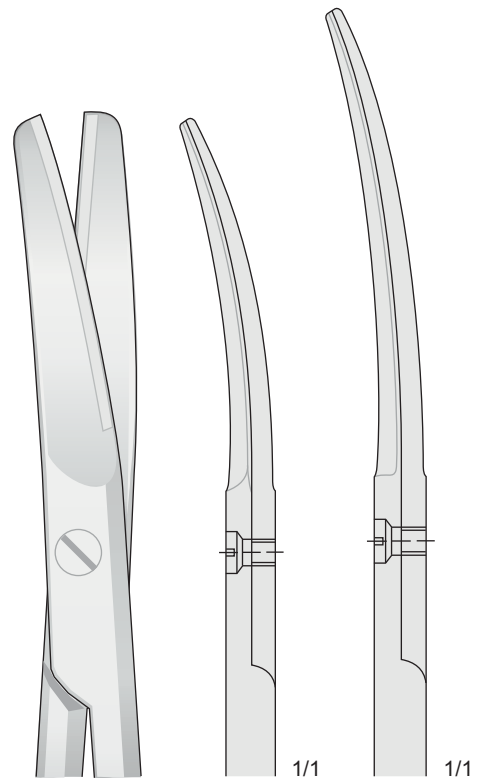
Con punta al carburo di tungsteno  
Tungsten-carbide scissors  
Mit Hartmetalleinsätzen  
Avec plaquettes en carbure de tungstène  
Tijeras de tungsteno



WERTHEIM  
FM-190/FM-194  
230 mm



SIMS  
FM-191/FM-192

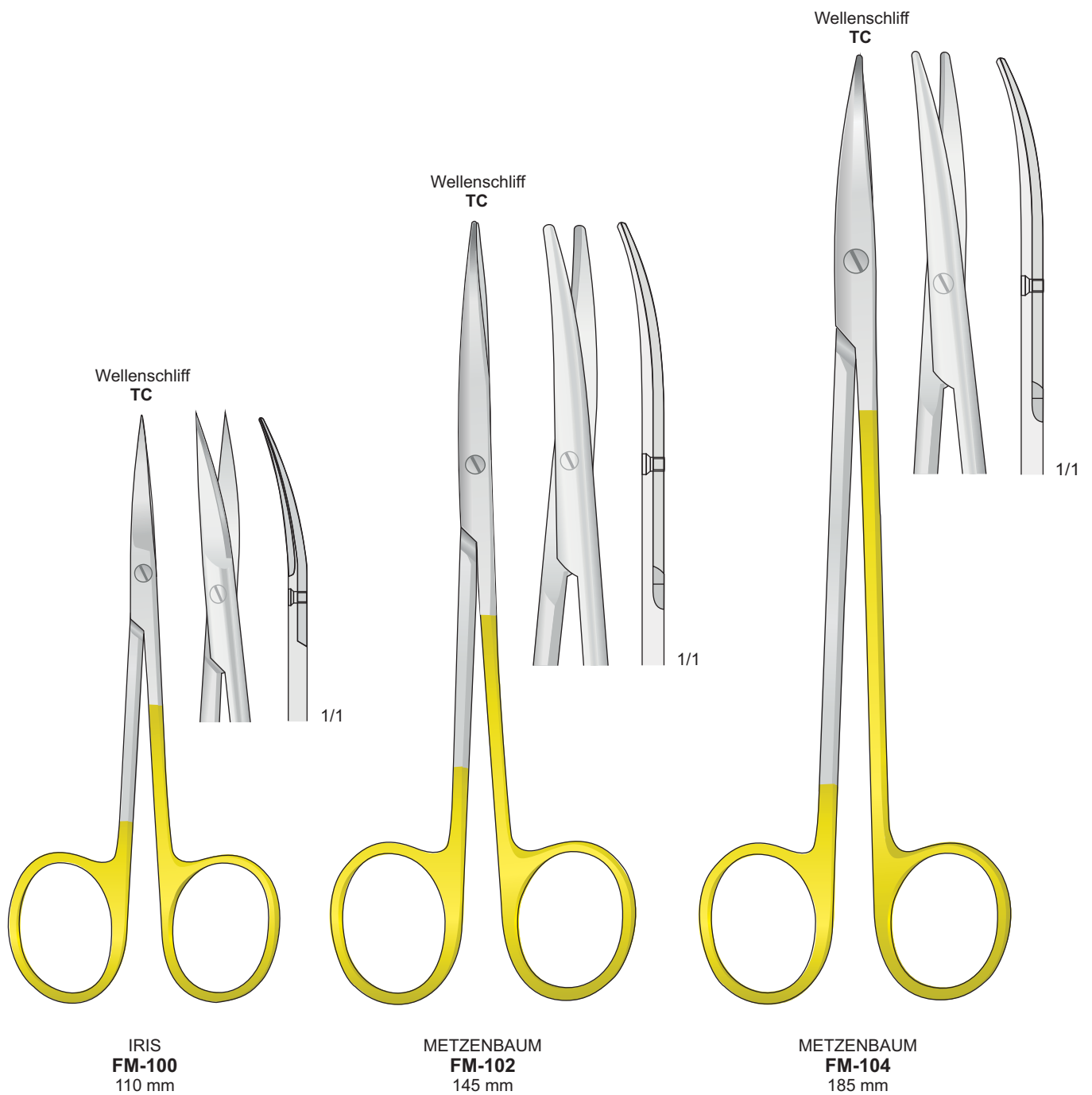


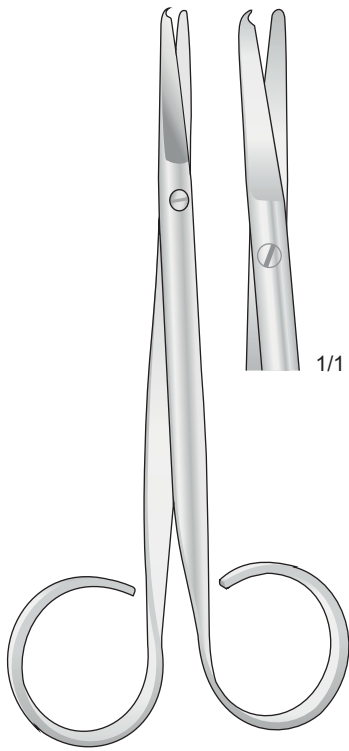
FM-191  
200 mm

FM-192  
230 mm

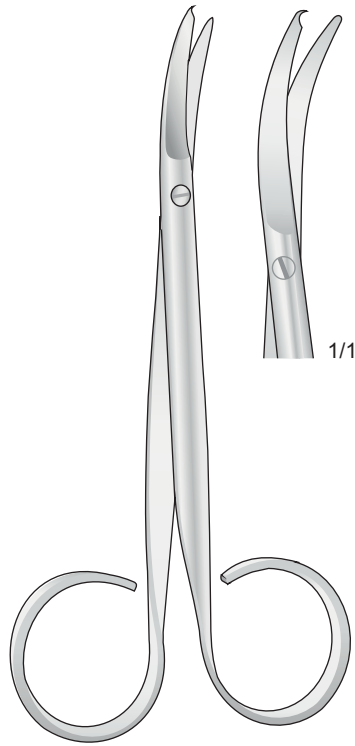


Forbici con taglio ondulato su una lama  
Scissors cut one serrated cutting edge  
Scheren mit wellenschliff auf einer Schnittfläche  
Ciseaux avec affutage spécial ont une lame dentée

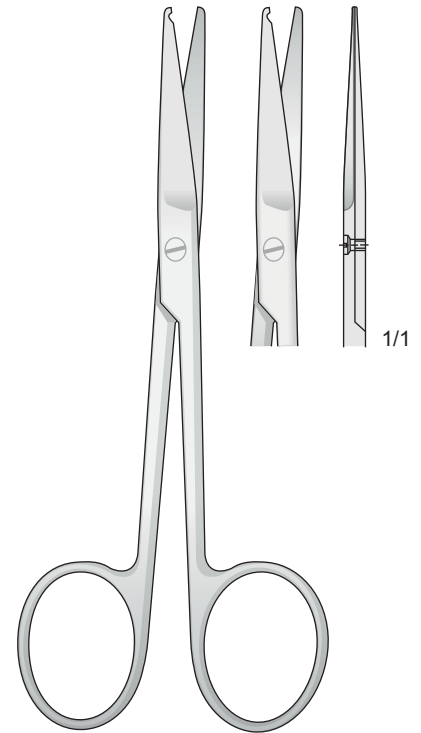




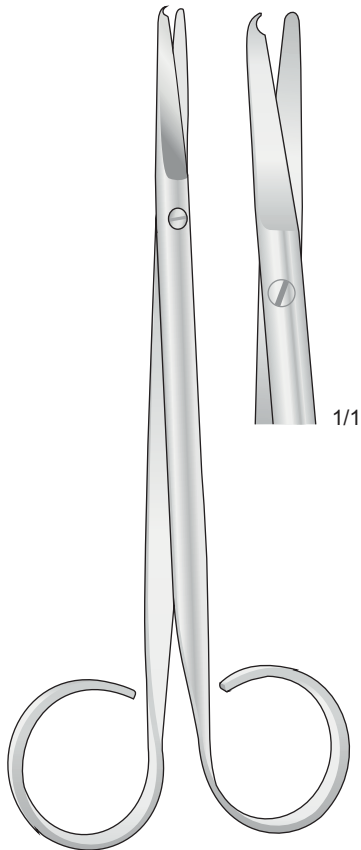
SPENCER  
**SC-1**  
110 mm



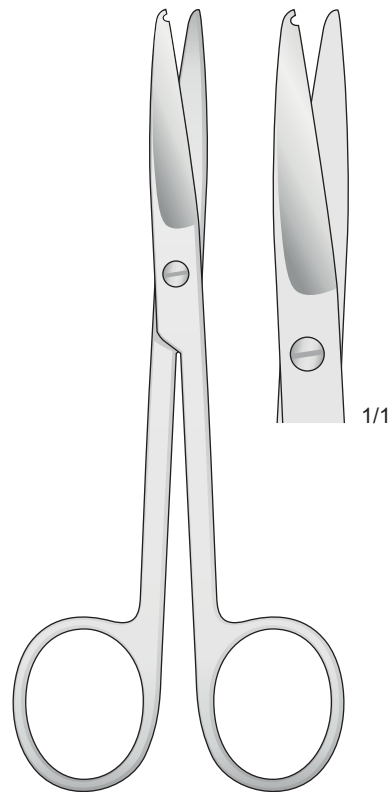
SPENCER  
**SC-5**  
110 mm



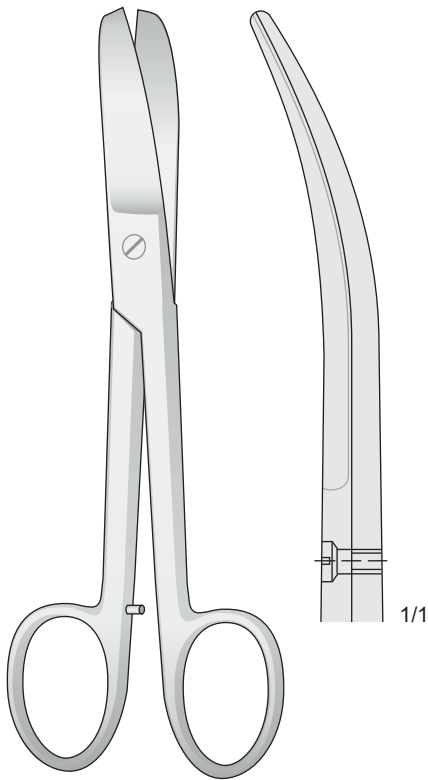
**SC-12**  
115 mm



SPENCER  
**SC-2**  
145 mm



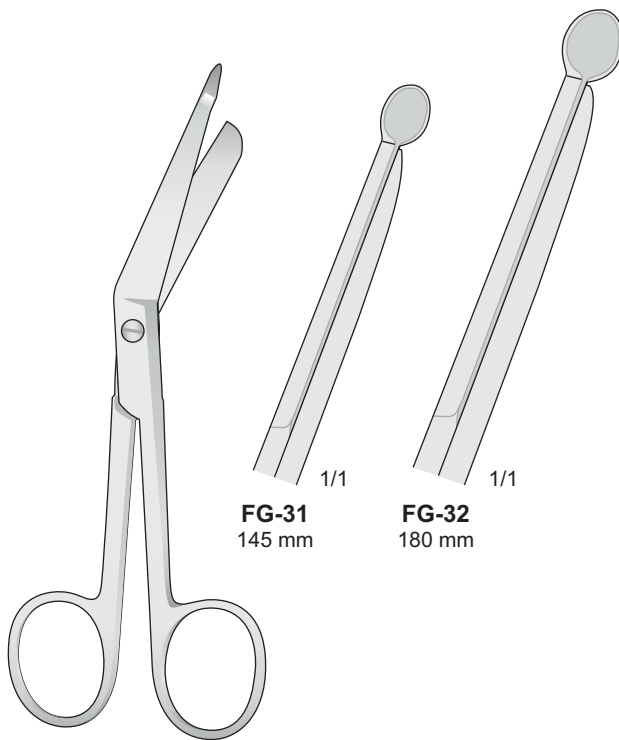
SPENCER  
**SC-10**  
135 mm



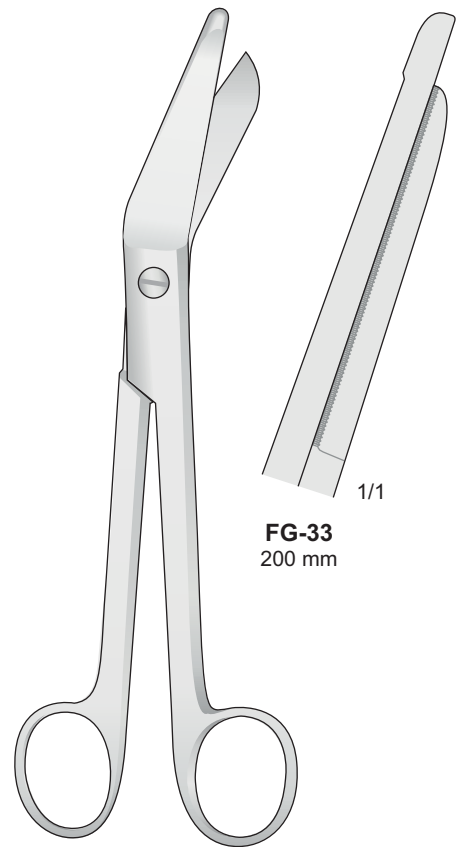
LORENZ  
FG-150  
230 mm



BRUNS  
FG-181  
240 mm



LISTER  
FG-31/FG-32



ESMARCH  
FG-33



Forbici per  
fili metallici

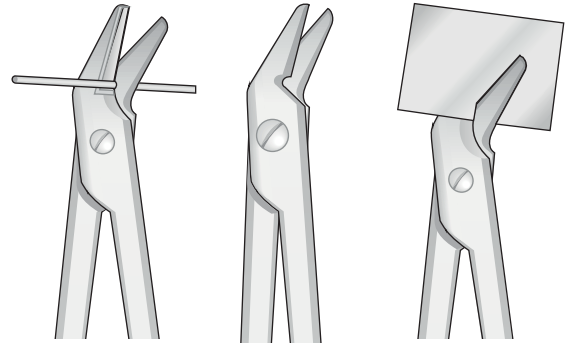
Wire and plate  
cutting scissors

Draht und  
Blehscheren

Ciseaux coupe-fils  
métalliques

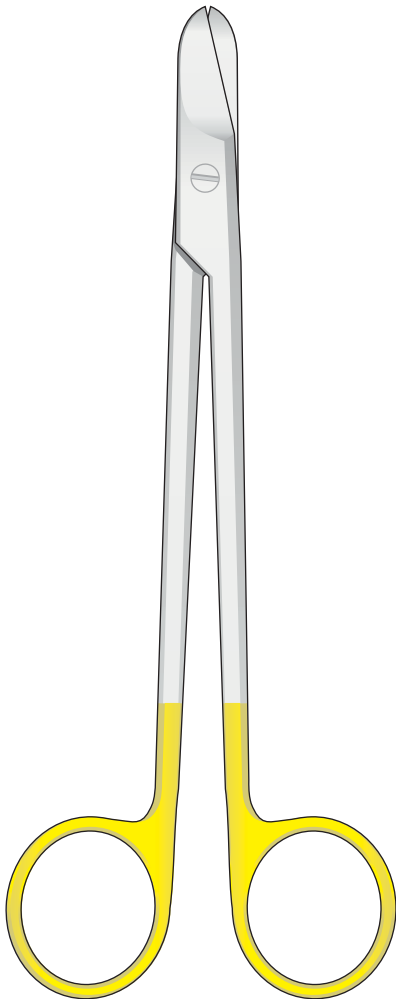
Tijeras para  
cortar alambre

Forbice universale dentellata  
Draht- und Blehschere gezahnt  
Wire cutting scissor serrated  
Coupe-fils dentelés  
Tijeras para cortar hilo de acero dentadas



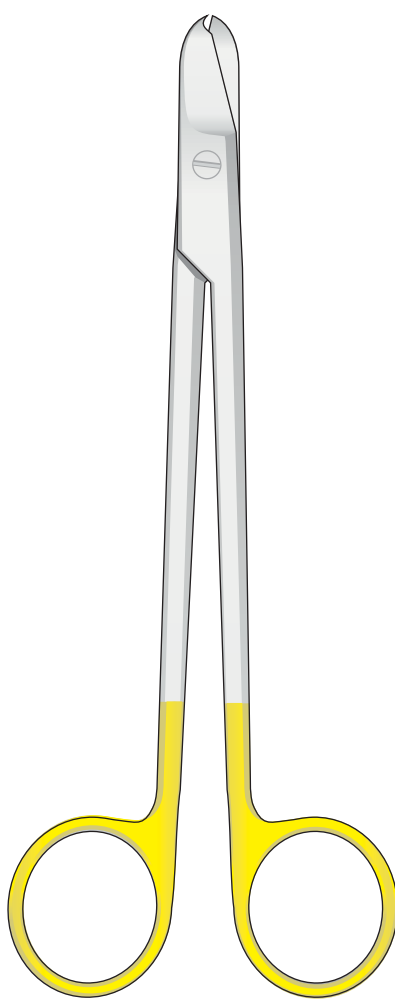
Con punta al carburo di tungsteno  
Tungsten-carbide scissors  
Mit Hartmetalleinsätzen  
Avec plaquettes en carbure de tungstène  
Tijeras de tungsteno

Wire Cutter  
TC



SMITH  
FG-160  
160 mm

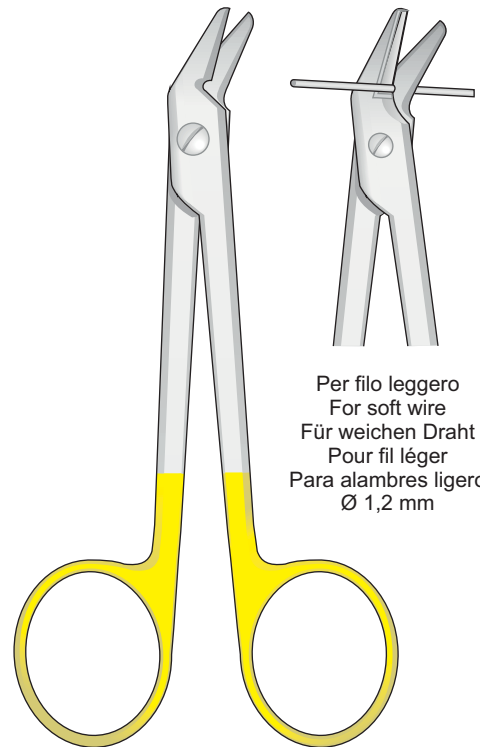
Wire Cutter  
TC



SMITH  
FG-161  
160 mm

DP-90  
120 mm

TC



DP-120  
120 mm

Per filo leggero  
For soft wire  
Für weichen Draht  
Pour fil léger  
Para alambres ligero  
Ø 1,2 mm



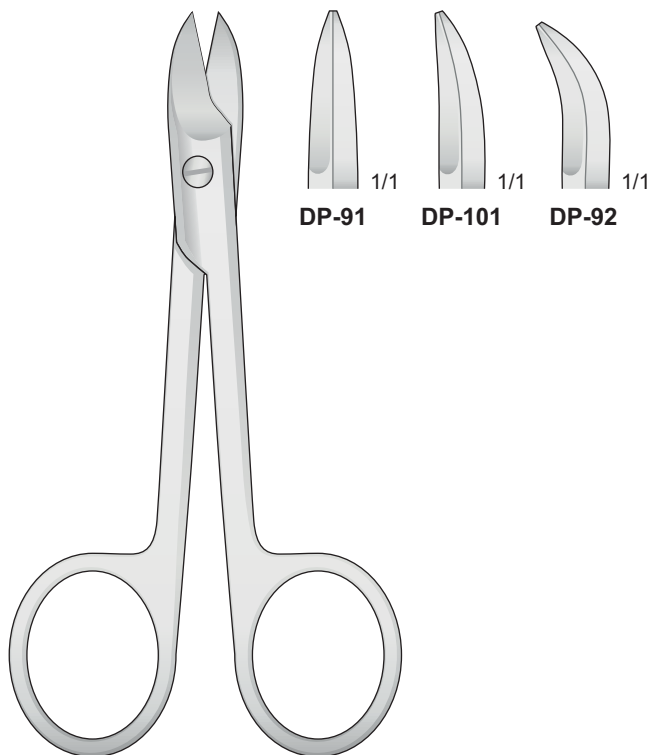


Smusse - Blunt - Stumpf - Mousse - Romas

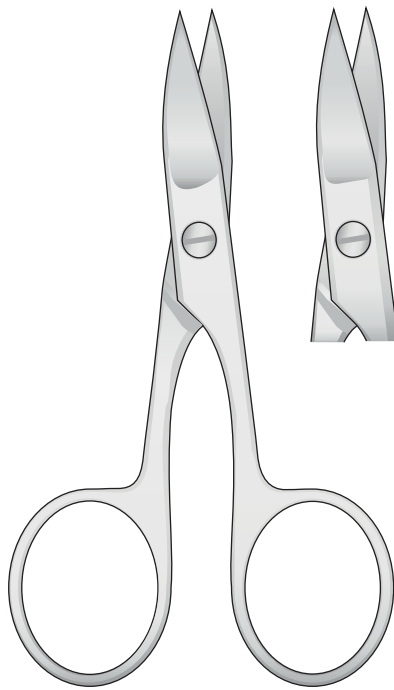


BEEBE  
DP-102/DP-105  
110 mm

Acute - Sharp - Spitz - Pointus - Agudas



BEEBE  
DP-91/DP-101  
110 mm



**GS-23/GS-26**



1/1

**GS-23**  
90 mm



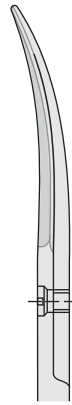
1/1

**GS-24**  
90 mm



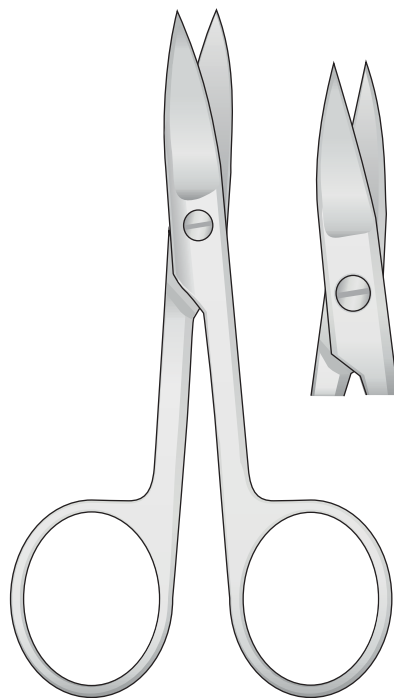
1/1

**GS-25**  
100 mm

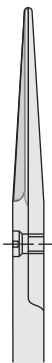


1/1

**GS-26**  
110 mm

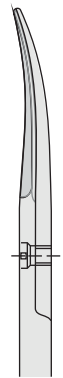


**GS-27/GS-29**



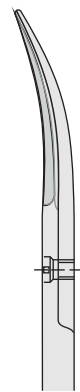
1/1

**GS-27**  
95 mm



1/1

**GS-28**  
95 mm



1/1

**GS-29**  
105 mm



4

Pinzette  
Tissue forceps  
Pinzetten  
Pincés  
Pinzas





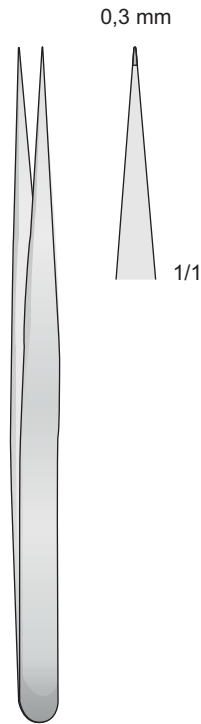
Micro pinzette

Delicate forceps

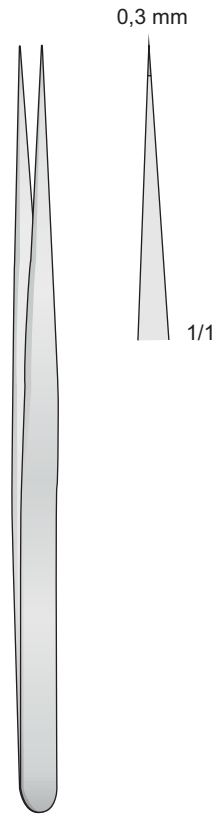
Micro Pinzetten

Micro pinces

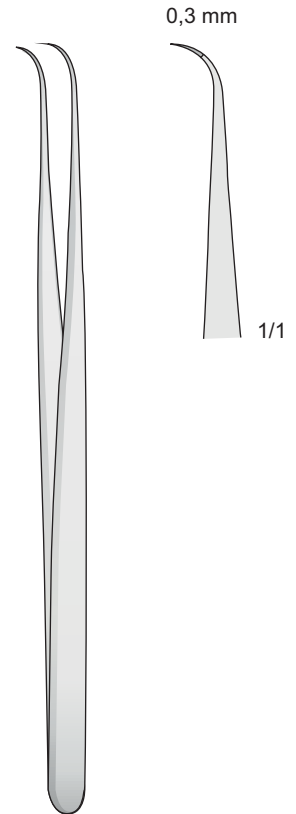
Pinzas finos



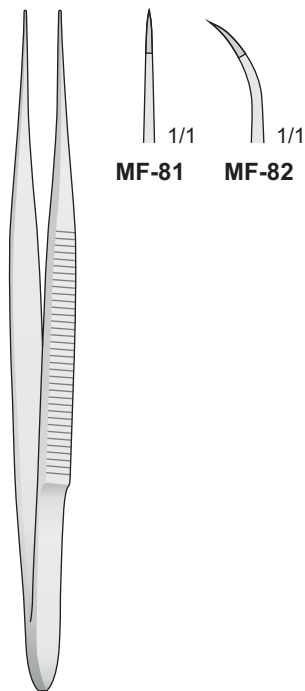
**BD-235**  
120 mm



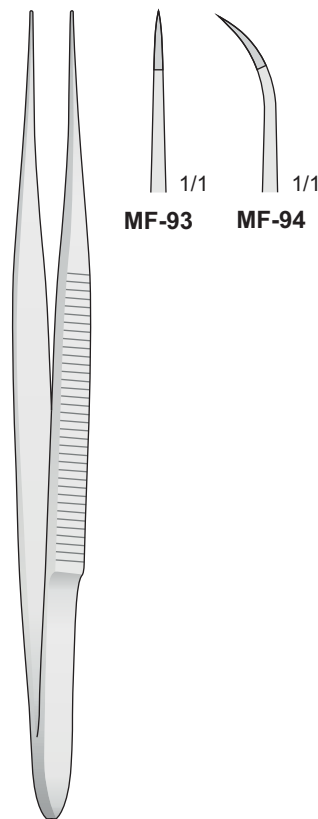
**VISE**  
**BD-236**  
135 mm



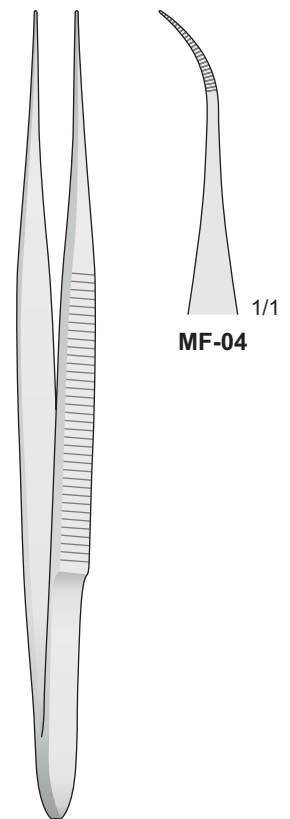
**VISE**  
**BD-237**  
135 mm



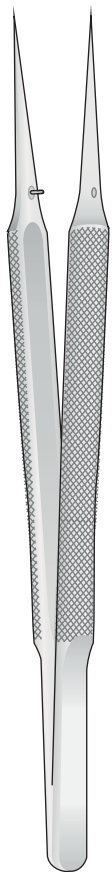
**MF-81/MF-82**  
125 mm



**MF-93/MF-94**  
150 mm

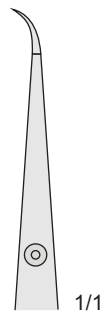


**MF-04**  
150 mm



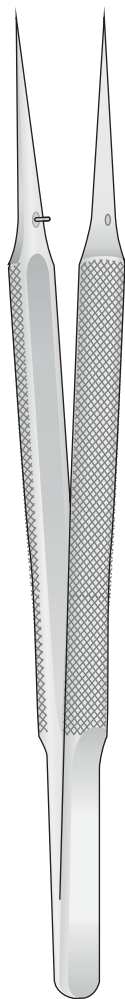
**MF-110**

1/1



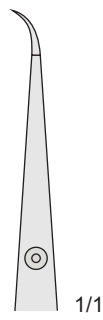
**MF-111**

1/1



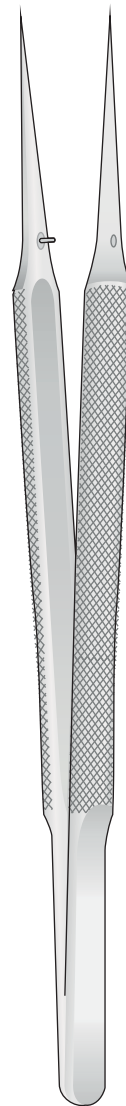
**MF-112**

1/1



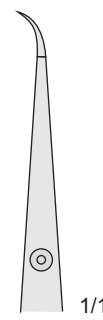
**MF-113**

1/1



**MF-114**

1/1



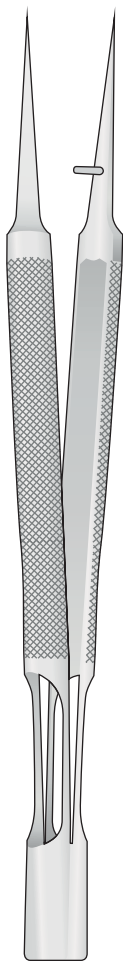
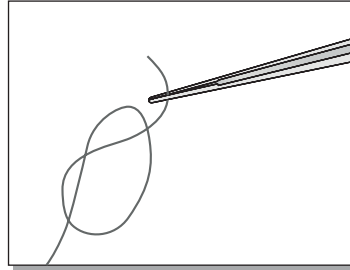
**MF-115**

1/1

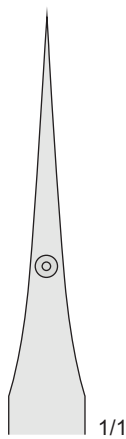
**MF-110/MF-111**  
120 mm

**MF-112/MF-113**  
150 mm

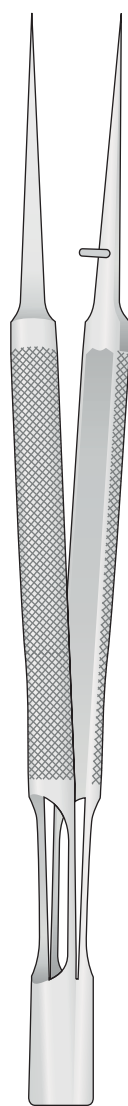
**MF-114/MF-115**  
180 mm



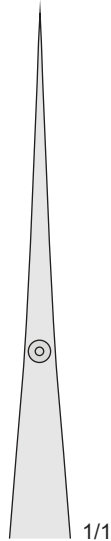
**BROCK  
FD-201**  
130 mm



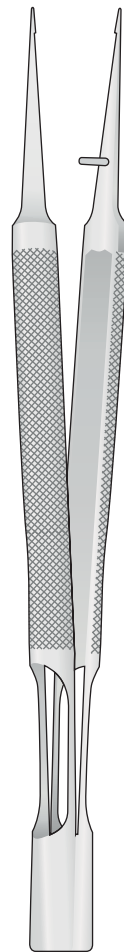
1/1



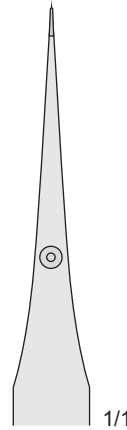
**BROCK  
FD-202**  
150 mm



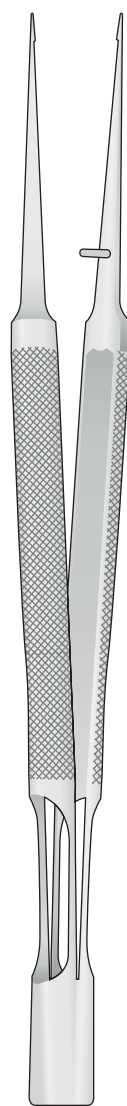
1/1



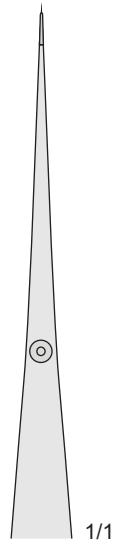
**BROCK  
FD-203**  
130 mm



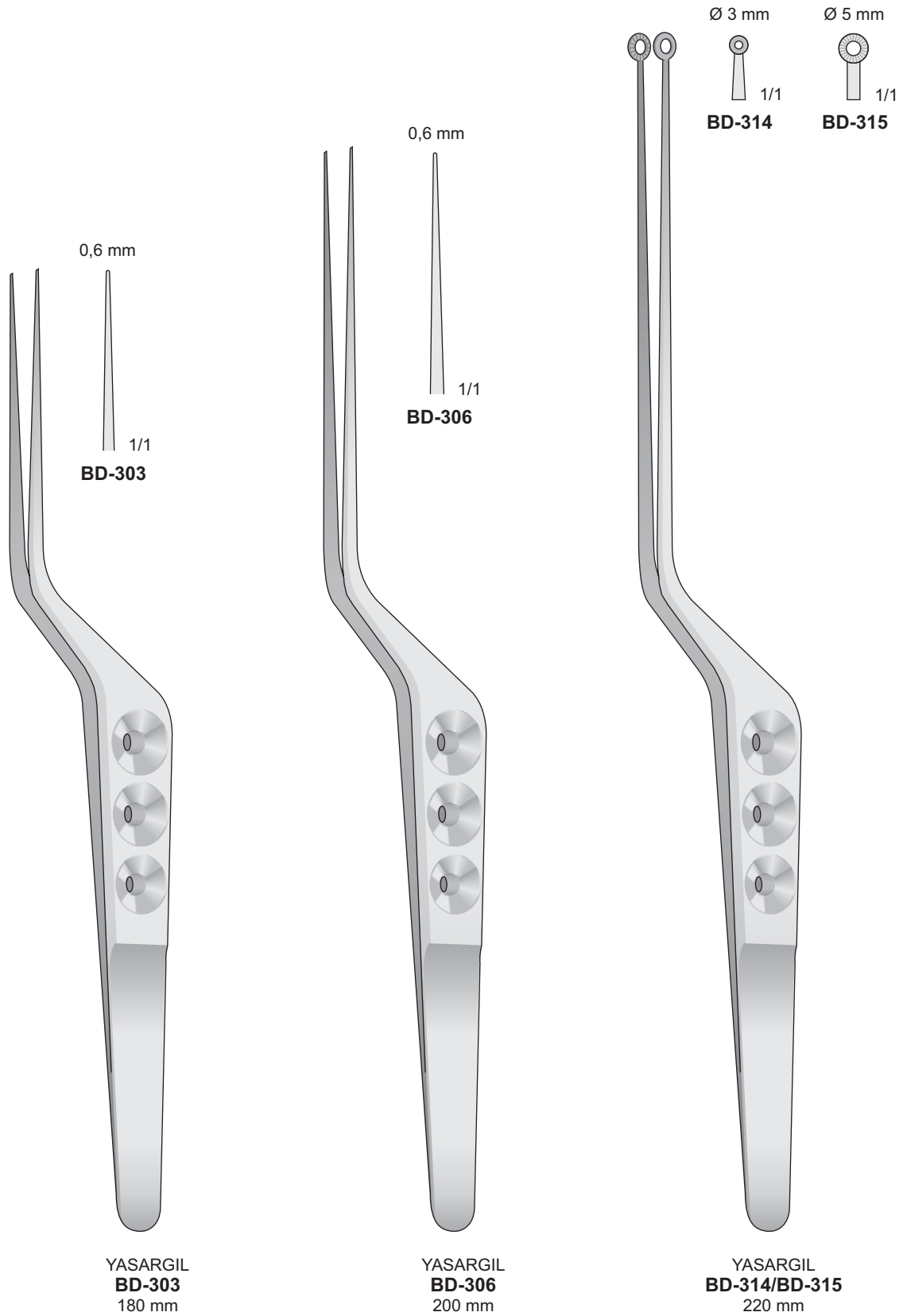
1/1



**BROCK  
FD-204**  
150 mm



1/1







MF-124/MF-149

Ø 1 mm



- MF-124 - 150 mm
- MF-125 - 180 mm
- MF-126 - 210 mm
- MF-148 - 230 mm

Ø 2 mm



- MF-127 - 150 mm
- MF-128 - 180 mm
- MF-129 - 210 mm
- MF-149 - 230 mm

Titanio - Titan - Titane

Ø 1 mm



- MF-142 T - 150 mm
- MF-143 T - 180 mm
- MF-144 T - 210 mm

Ø 2 mm



- MF-145 T - 150 mm
- MF-146 T - 180 mm
- MF-147 T - 210 mm



MF-142 T/MF-147 T



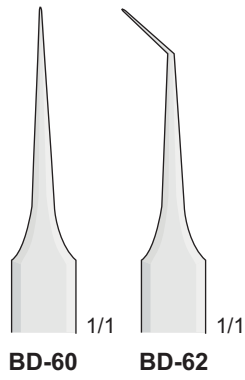
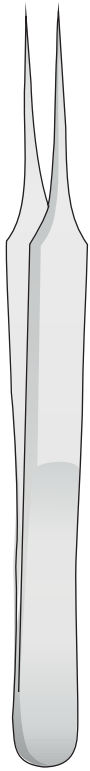
Micro pinzette

Delicate forceps

Micro Pinzetten

Micro pincers

Pinzas finos



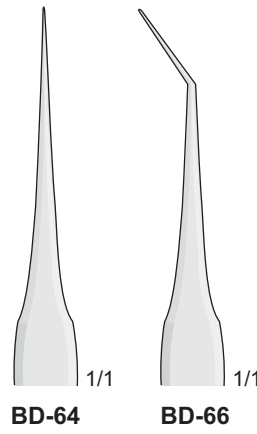
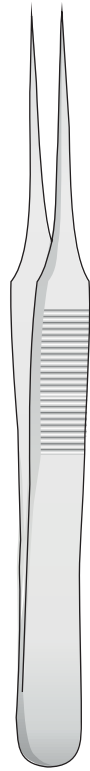
BD-60

BD-62

1/1

1/1

BD-60/BD-62  
110 mm



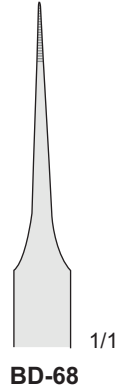
BD-64

BD-66

1/1

1/1

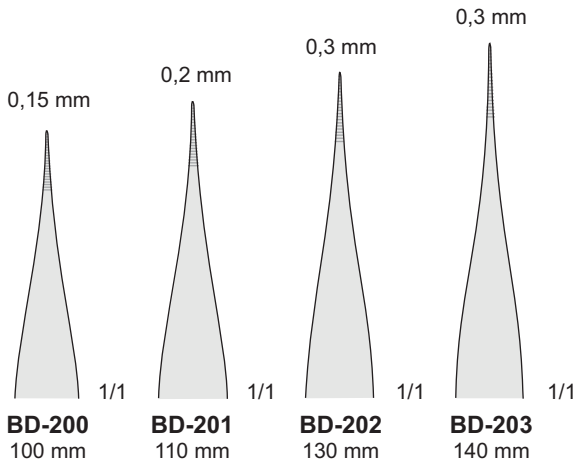
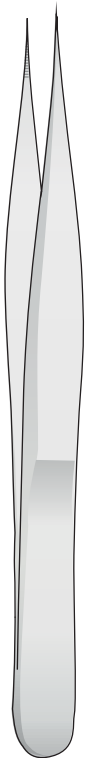
BD-64/BD-66  
110 mm



BD-68

1/1

BD-68  
90 mm



BD-200  
100 mm

BD-201  
110 mm

BD-202  
130 mm

BD-203  
140 mm

0,15 mm

0,2 mm

0,3 mm

0,3 mm

1/1

1/1

1/1

1/1

BD-200/BD-203



BD-205  
115 mm



BD-206  
115 mm



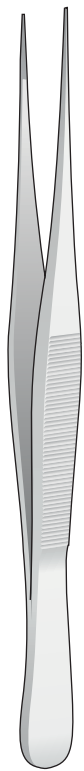
Pinze per dissezione

Thumb and tissue forceps

Pinzetten

Pinces à dissection

Pinzas de disección



BD-32

BD-33

1/1

1/1

BD-32/BD-33  
100 mm



BD-34

1/1

BD-34  
100 mm



BD-35

BD-36

1/1

1/1

BD-35/BD-36  
100 mm



BD-40

1/1

BD-40  
110 mm



BD-41

1/1

BD-41  
110 mm



BD-42

BD-43

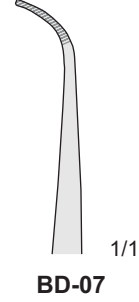
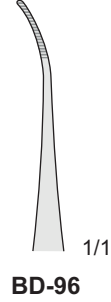
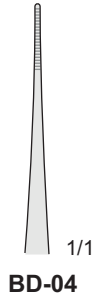
1/1

1/1

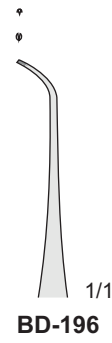
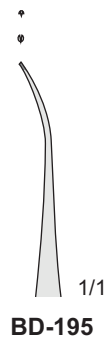
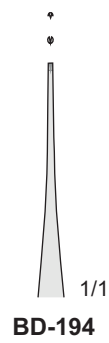
BD-42/BD-43  
110 mm



GRAEFE  
BD-04/BD-07  
100 mm



GRAEFE  
BD-194/BD-196  
100 mm





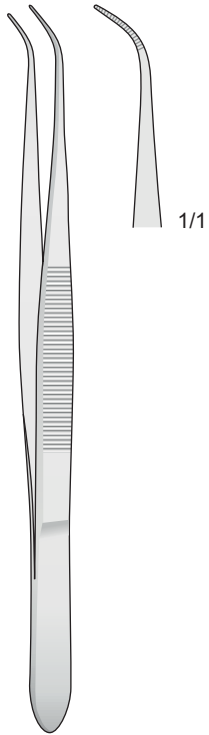
Pinzette chirurgiche

Tissue forceps

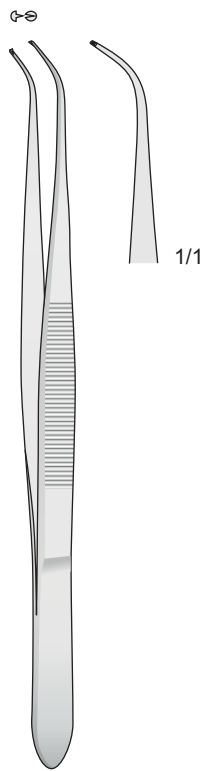
Chirurgische pinzetten

Pinces chirurgicales

Pinzas quirúrgicas



PERRY  
**BD-05**  
125 mm

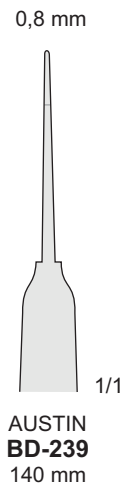


PERRY  
**BD-06**  
125 mm

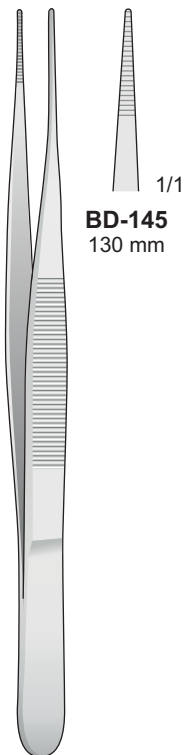


**BD-238/BD-239**

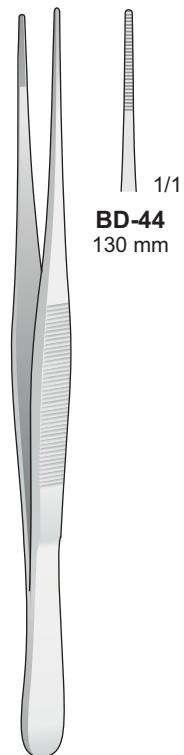
1x2 denti  
0,2 mm  
1/1  
**BD-238**  
95 mm



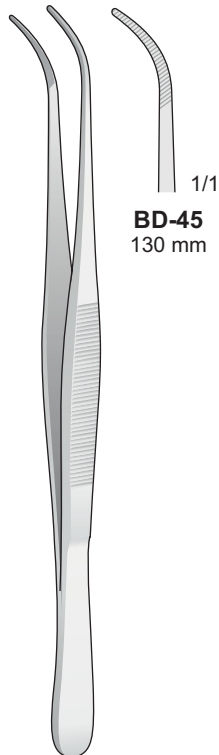
**AUSTIN**  
**BD-239**  
140 mm



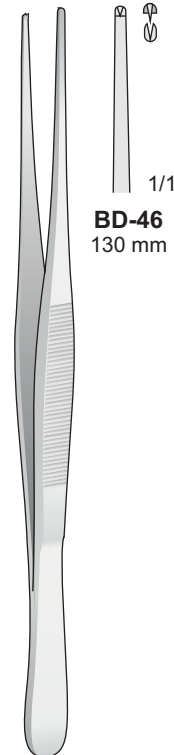
**BD-145**  
130 mm



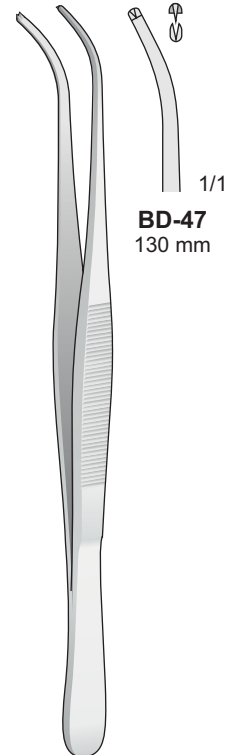
SEMKEN  
**BD-44**  
130 mm



SEMKEN  
**BD-45**  
130 mm



SEMKEN  
**BD-46**  
130 mm



SEMKEN  
**BD-47**  
130 mm



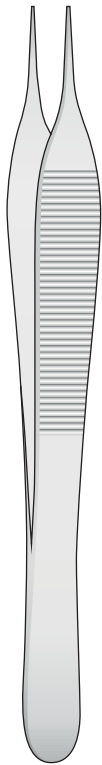
Pinzette chirurgiche

Tissue forceps

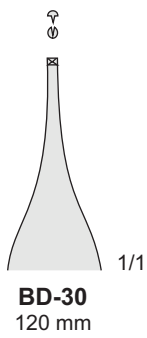
Chirurgische pinzetten

Pinces chirurgicales

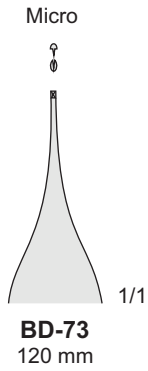
Pinzas quirúrgicas



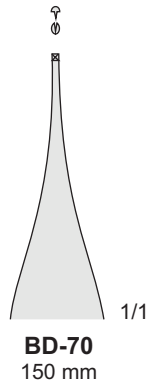
ADSON  
BD-30/BD-73



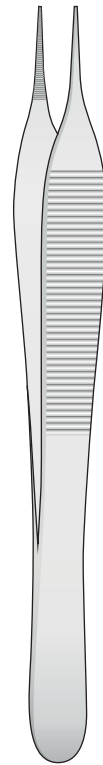
**BD-30**  
120 mm



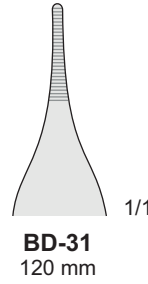
**BD-73**  
120 mm



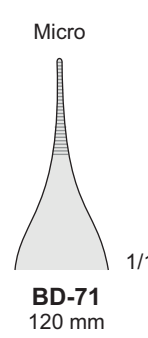
**BD-70**  
150 mm



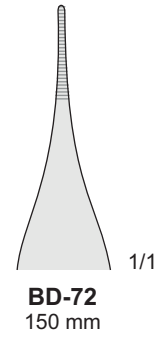
ADSON  
BD-31/BD-72



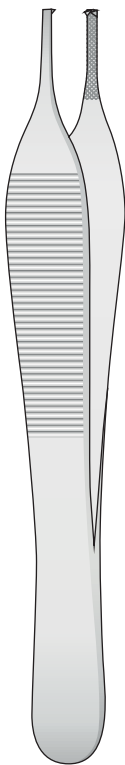
**BD-31**  
120 mm



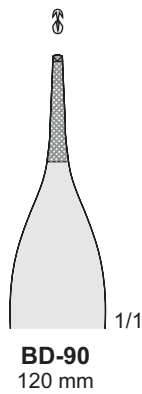
**BD-71**  
120 mm



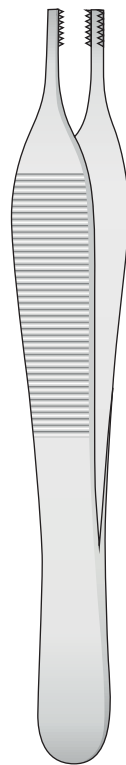
**BD-72**  
150 mm



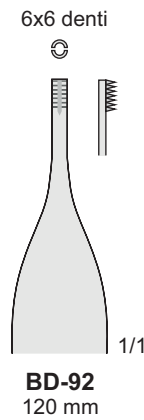
ADSON  
BD-90  
120 mm



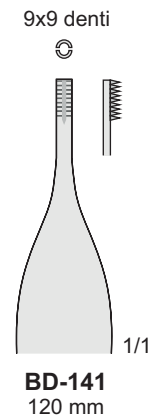
**BD-90**  
120 mm



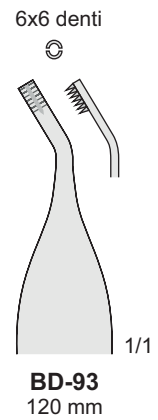
ADSON-BROWN  
BD-92/BD-141  
120 mm



**BD-92**  
120 mm



**BD-141**  
120 mm












**BD-93**  
120 mm



Standard











								
1/1	1/1	1/1	1/1	1/1	1/1	1/1	1/1	1/1
<b>BD-97</b> 100 mm	<b>BD-98</b> 115 mm	<b>BD-99</b> 130 mm	<b>BD-100</b> 145 mm	<b>BD-105</b> 160 mm	<b>BD-124</b> 180 mm	<b>BD-126</b> 200 mm	<b>BD-78</b> 250 mm	<b>BD-79</b> 300 mm

BD-78/BD-126

Mod. Fine



							
1/1	1/1	1/1	1/1	1/1	1/1	1/1	1/1
<b>BD-10</b> 145 mm	<b>BD-75</b> 145 mm	<b>BD-74</b> 145 mm	<b>BD-76</b> 200 mm	<b>BD-23</b> 230 mm	<b>BD-24</b> 250 mm	<b>BD-25</b> 250 mm	<b>BD-26</b> 300 mm

BD-10/BD-76



Pinzette anatomiche

Dressing forceps

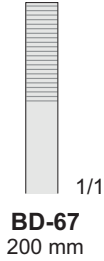
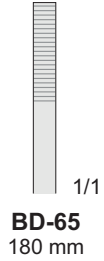
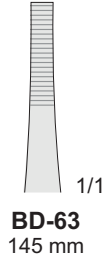
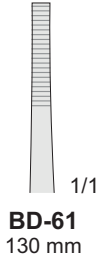
Anatomische Pinzetten

Pinces anatomiques

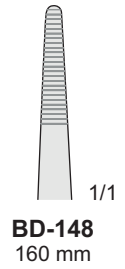
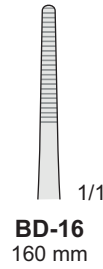
Pinzas de diseccion



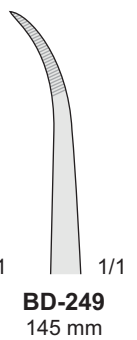
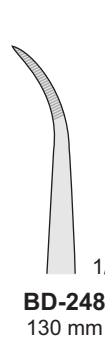
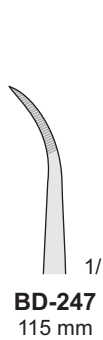
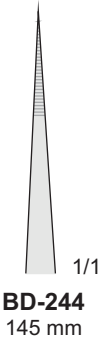
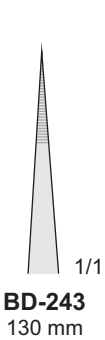
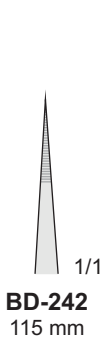
STILLE  
BD-61/BD-67



BD-16/BD-148  
160 mm



BD-240/BD-249







Pinzette chirurgiche

Tissue forceps

Chirurgische pinzetten

Pinces chirurgicales

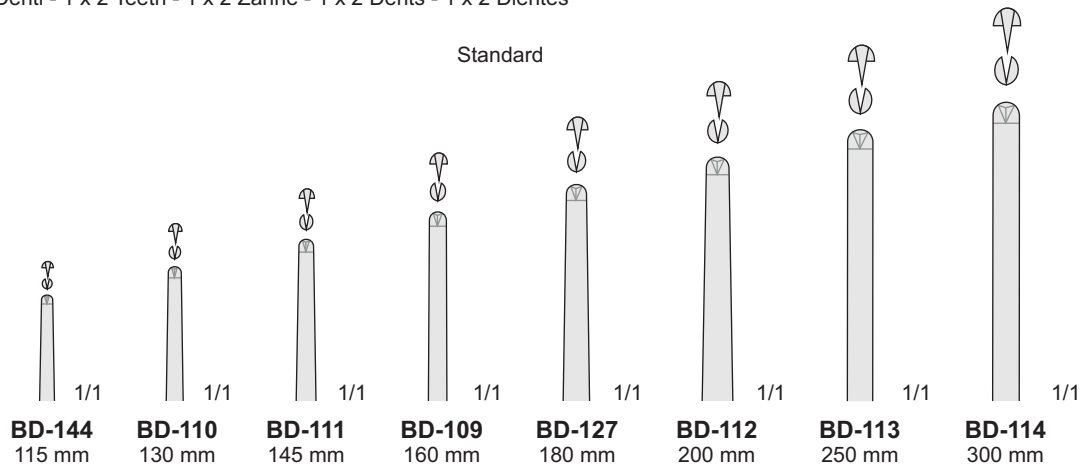
Pinzas quirúrgicas



1 x 2 Denti - 1 x 2 Teeth - 1 x 2 Zähne - 1 x 2 Dents - 1 x 2 Dientes



Standard



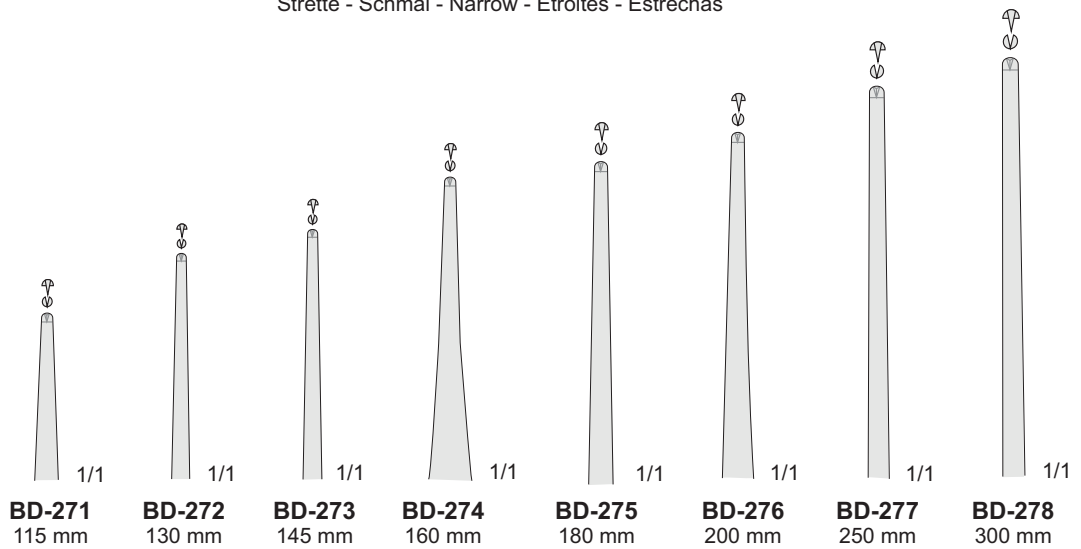
BD-109/BD-144



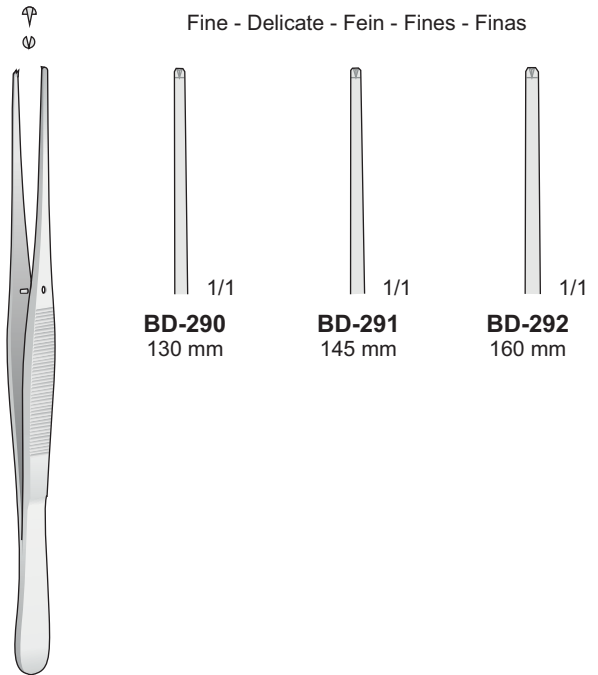
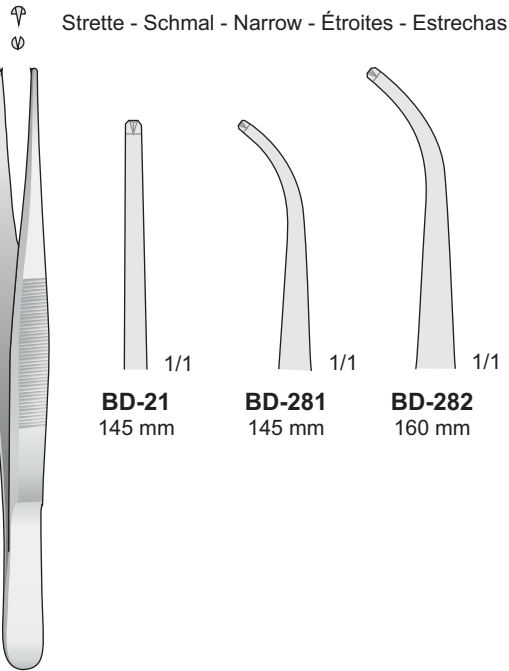
1 x 2 Denti - 1 x 2 Teeth - 1 x 2 Zähne - 1 x 2 Dents - 1 x 2 Dientes



Strette - Schmal - Narrow - Étroites - Estrechas

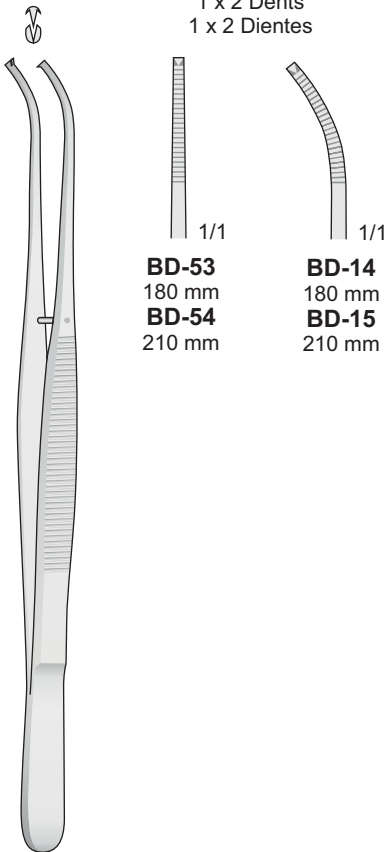


BD-271/BD-278



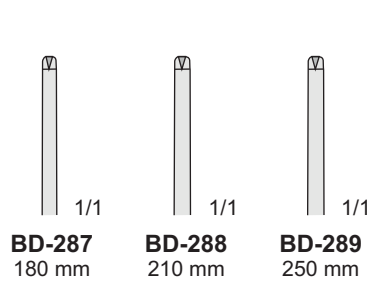
**BD-21/BD-282**

- 1 x 2 Denti
- 1 x 2 Teeth
- 1 x 2 Zähne
- 1 x 2 Dents
- 1 x 2 Dientes



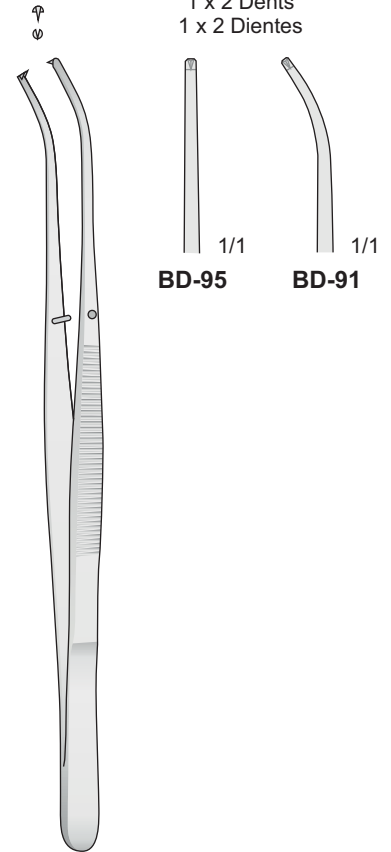
POTTS-SMITH  
**BD-14/BD-54**

**BD-290/BD-292**



POTTS-SMITH  
**BD-287/BD-289**

- 1 x 2 Denti
- 1 x 2 Teeth
- 1 x 2 Zähne
- 1 x 2 Dents
- 1 x 2 Dientes



SEMKEN  
**BD-91/BD-95**  
150 mm



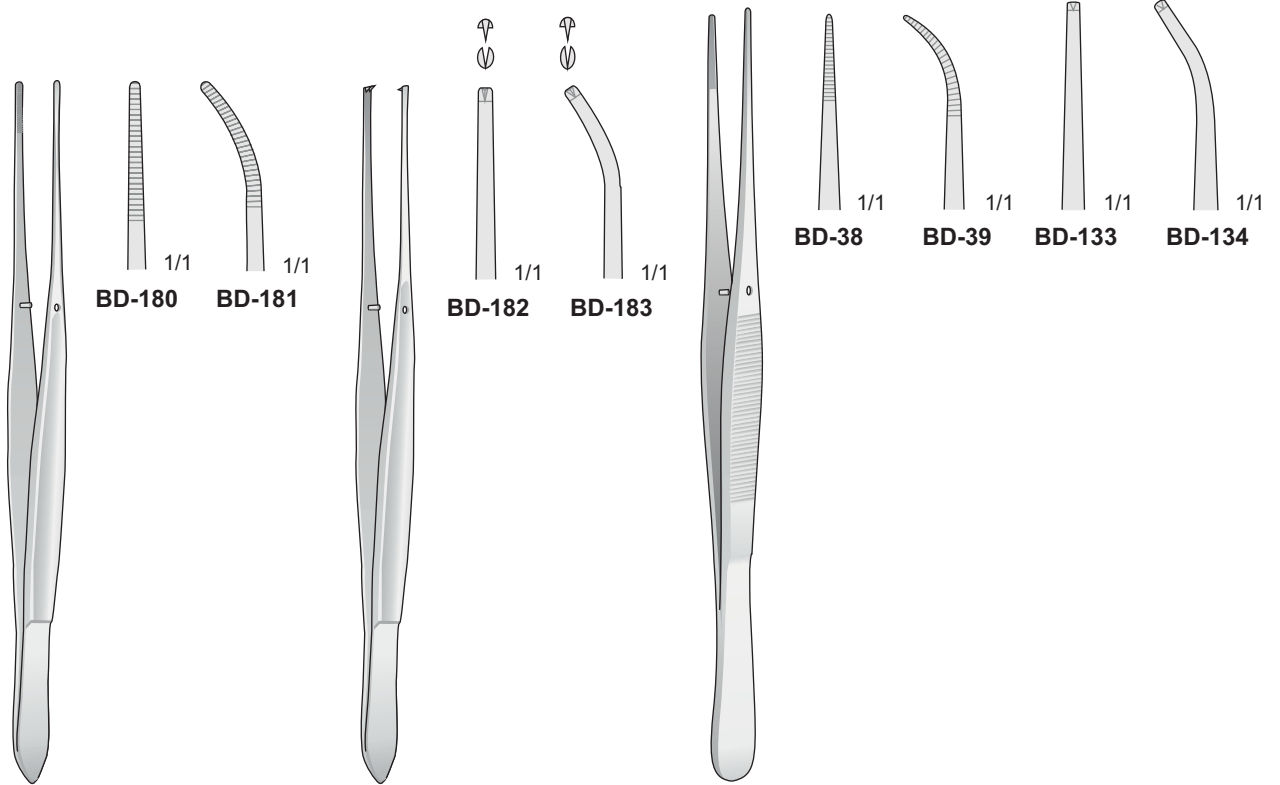
Pinzette chirurgiche

Tissue forceps

Chirurgische pinzetten

Pinces chirurgicales

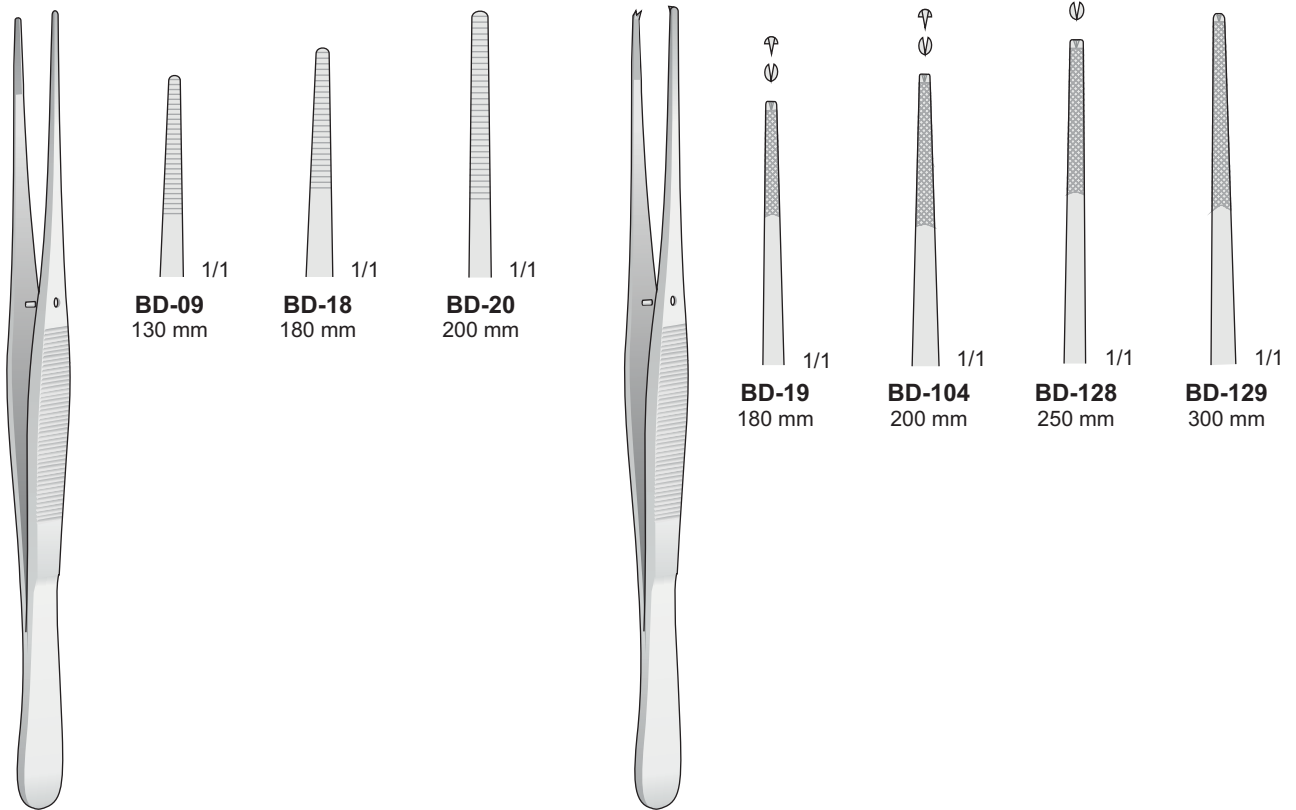
Pinzas quirúrgicas



CUSHING  
BD-180/BD-181  
175 mm

CUSHING  
BD-182/BD-183  
175 mm

BD-38/BD-134  
200 mm



BD-09/BD-20

BD-19/BD-129



Pinzette chirurgiche

Tissue forceps

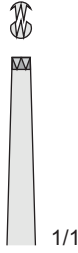
Chirurgische pinzetten

Pinces chirurgicales

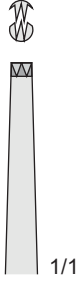
Pinzas quirúrgicas



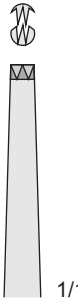
2 x 3 Denti - 2 x 3 Teeth - 2 x 3 Zähne  
2 x 3 Dents - 2 x 3 Dientes



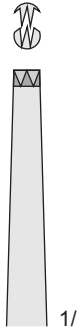
**BD-106**  
115 mm



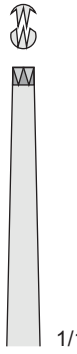
**BD-138**  
145 mm



**BD-107**  
160 mm



**BD-139**  
180 mm



**BD-108**  
200 mm

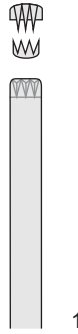
**BD-106/BD-139**



3 x 4 Denti - 3 x 4 Teeth - 3 x 4 Zähne  
3 x 4 Dents - 3 x 4 Dientes



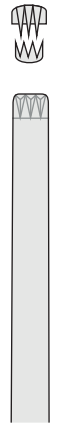
**BD-115**  
145 mm



**BD-119**  
160 mm



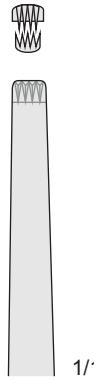
**BD-116**  
200 mm



**BD-117**  
250 mm



4 x 5 Denti  
4 x 5 Teeth  
4 x 5 Zähne  
4 x 5 Dents  
4 x 5 Dientes



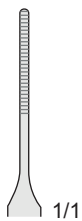
**BD-118**  
145 mm



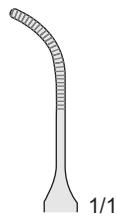
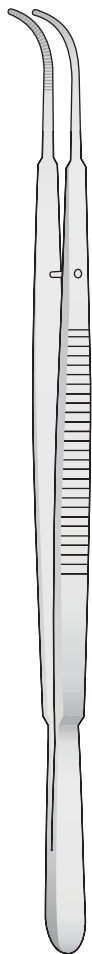
**BD-149**  
160 mm

**BD-115/BD-119**

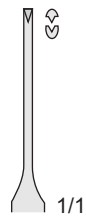
**BD-118/BD-149**



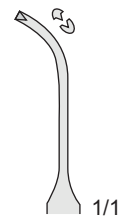
**GERALD MF-101**  
180 mm



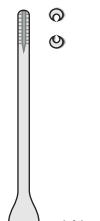
**GERALD MF-102**  
180 mm



**GERALD MF-103**  
180 mm



**GERALD MF-104**  
180 mm



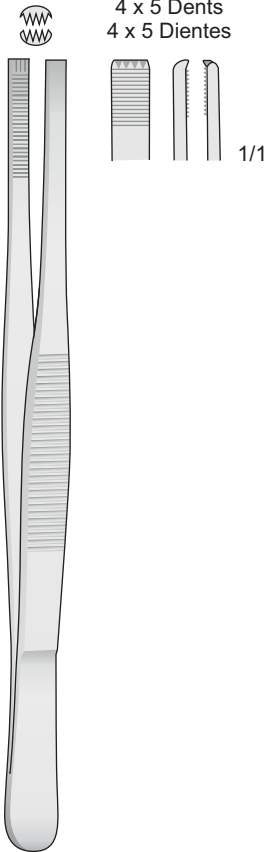
**GERALD-BROWN MF-105**  
180 mm



Pinzette per vasi e per tumori  
Vascular and tumor forceps  
Gefäß und Tumorpinzetten  
Pinces vasculaires et pour tumeurs

3 x 4 Denti  
3 x 4 Teeth  
3 x 4 Zähne  
3 x 4 Dents  
3 x 4 Dientes

4 x 5 Denti  
4 x 5 Teeth  
4 x 5 Zähne  
4 x 5 Dents  
4 x 5 Dientes



ADLERKREUTZ  
BD-28 - 150 mm  
BD-155 - 200 mm  
BD-156 - 250 mm

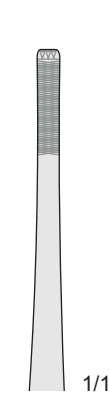
2 x 3 Denti  
2 x 3 Teeth  
2 x 3 Zähne  
2 x 3 Dents  
2 x 3 Dientes



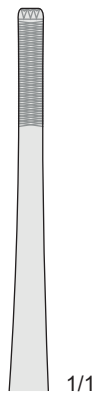
ADLERKREUTZ  
BD-153 - 150 mm  
BD-154 - 200 mm



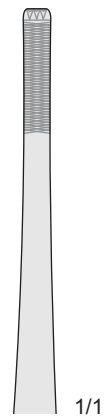
STILLE-BARRAYA  
BD-17/BD-185



BD-17  
180 mm



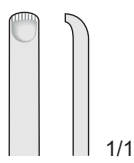
BD-184  
200 mm



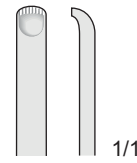
BD-185  
250 mm



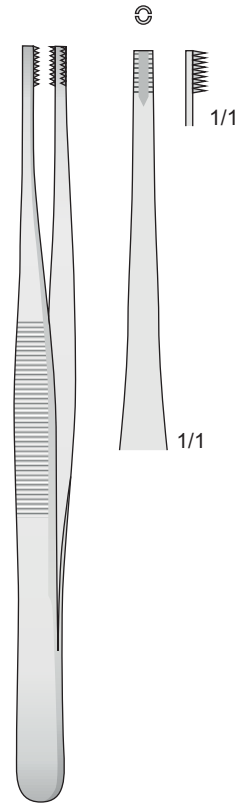
DURANTE  
BD-151/BD-152



BD-151  
140 mm



BD-152  
160 mm

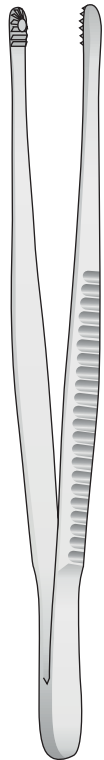


BROWN  
BD-94  
150 mm

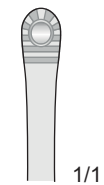
- 8 x 8 Denti
- 8 x 8 Teeth
- 8 x 8 Zähne
- 8 x 8 Dents
- 8 x 8 Dientes

1/1

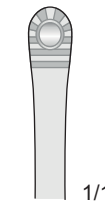
1/1



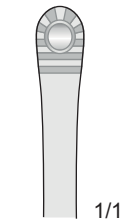
RUSSIAN  
BD-27/BD-176



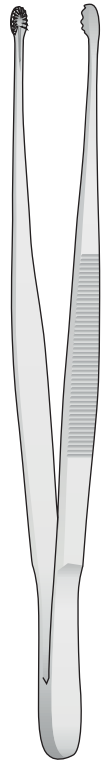
BD-27  
150 mm



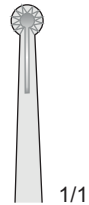
BD-175  
200 mm



BD-176  
250 mm



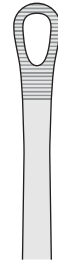
SELMAN  
BD-157  
150 mm



1/1



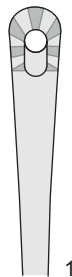
SINGLEY-TUTTLE  
BD-29  
230 mm



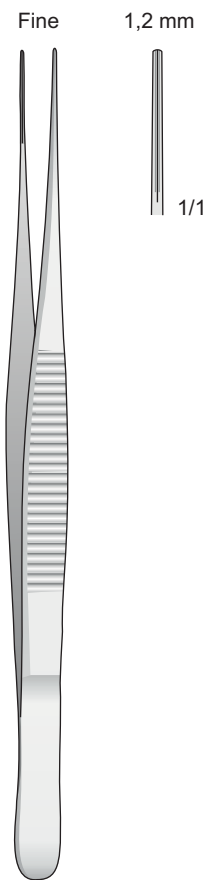
1/1



MAYO-RUSSIAN  
BD-37  
230 mm



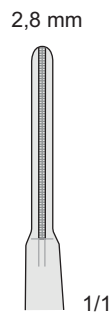
1/1



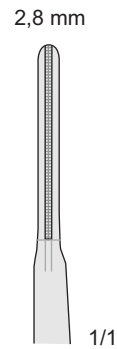
DE BAKEY  
**BD-186**  
195 mm



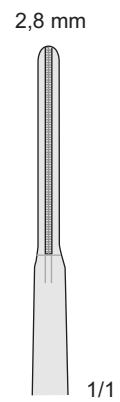
DE BAKEY  
**BD-190/BD-192**



**BD-190**  
200 mm

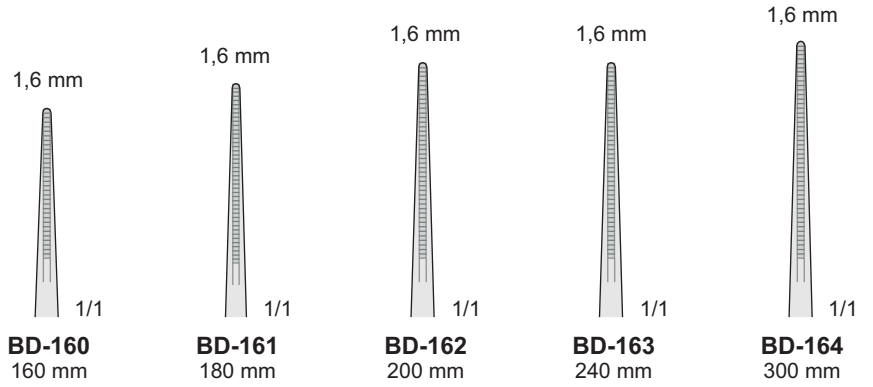


**BD-191**  
250 mm



**BD-192**  
300 mm

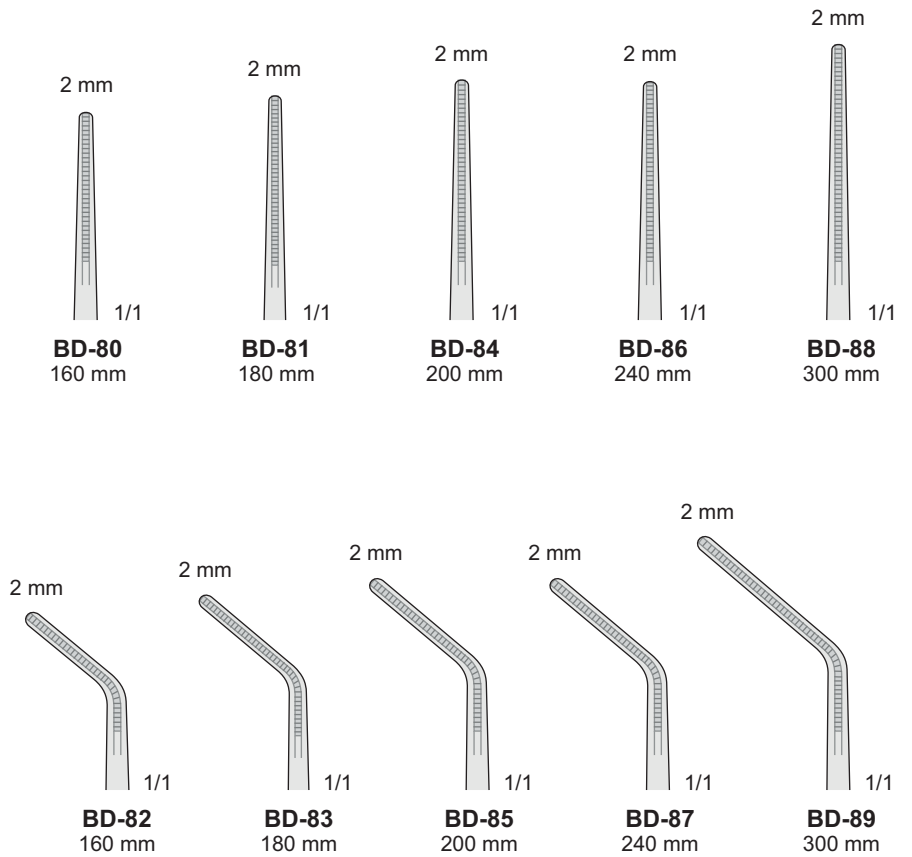


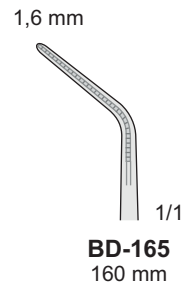


Pinzette atraumatiche  
Non-traumatic vascular tissue forceps  
Atraumatische pinzetten  
Pincés atraumáticas  
Pinzas atraumáticas



DE BAKEY  
**BD-80/BD-164**

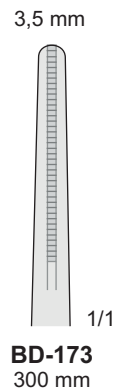
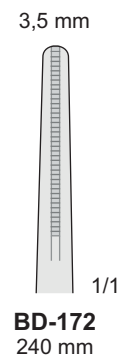
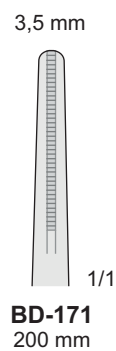
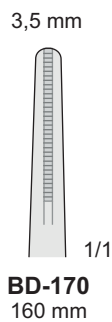
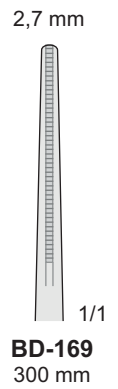
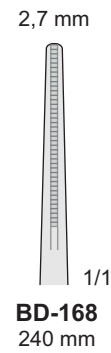
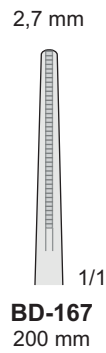
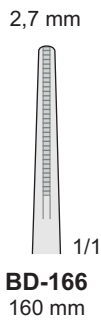




Pinzette atraumatiche  
Atraumatische pinzetten  
Atraumatic vascular tissue forceps  
Pincas atraumaticas  
Pinzas atraumaticas



DE BAKEY  
**BD-165/BD-173**





Micro pinzette

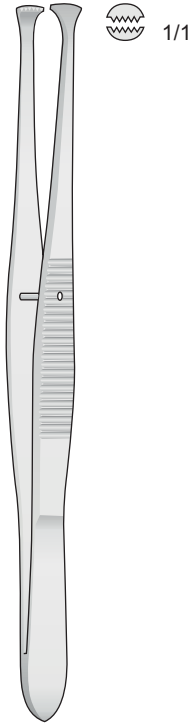
Delicate forceps

Micro Pinzetten

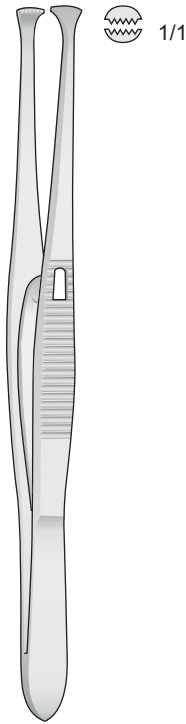
Micro pinces

Pinzas finos

Pinze da Fissazione-oftalmica - Fixier und fasspinzetten  
Fixation and Grasping forceps - Pinzas de fijación y de aprehensión



**GRAEFE  
BD-135**  
110 mm

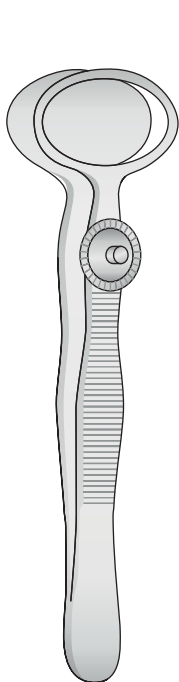
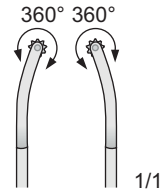


**GRAEFE  
BD-136**  
110 mm

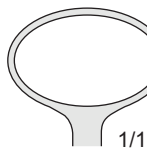
Pinzetta-Columella  
con stop



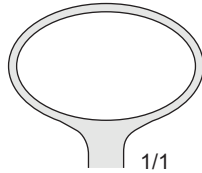
**COTTLE  
BD-140**  
100 mm



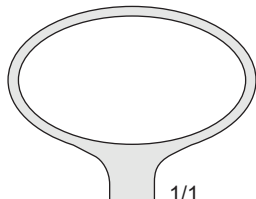
**DESMARRES  
BD-130/BD-132**  
90 mm



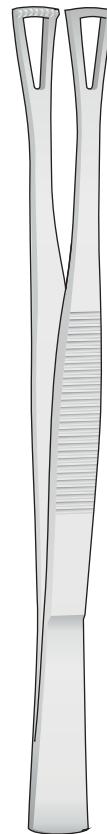
**BD-130**  
20 mm



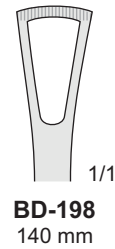
**BD-131**  
26 mm



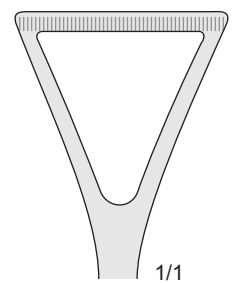
**BD-132**  
31 mm



**DUVAL  
BD-198/BD-199**



**BD-198**  
140 mm

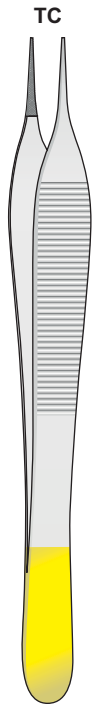


**BD-199**  
200 mm

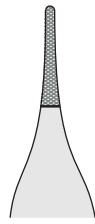
Pinze intestinali  
Intestinal forceps  
Darmpinzetten  
Pincés pour préhension de l'intestin  
Pinzas intestinales



Con punta al carburo di tungsteno - Tungsten-carbide forceps  
Mit hartmetalleinsätzen - Avec plaquettes en carbure de tungstène - Pinzas con tungsteno

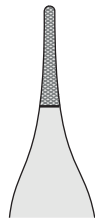


ADSON  
BD-230/BD-231



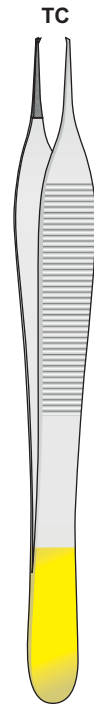
**BD-230**  
120 mm

1/1

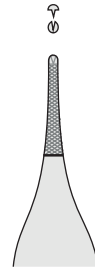


**BD-231**  
150 mm

1/1

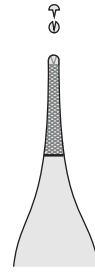


ADSON  
BD-250/BD-251



**BD-250**  
120 mm

1/1



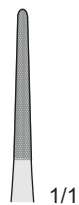
**BD-251**  
150 mm

1/1



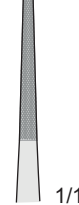
BD-210/BD-215

Standard



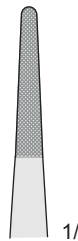
**BD-210**  
130 mm

1/1



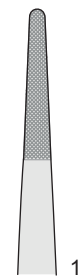
**BD-211**  
145 mm

1/1



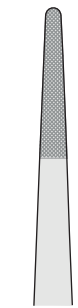
**BD-212**  
160 mm

1/1



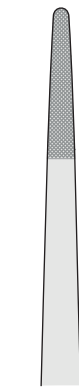
**BD-213**  
180 mm

1/1



**BD-214**  
200 mm

1/1

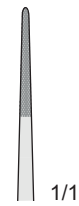


**BD-215**  
250 mm

1/1



SEMKEN  
BD-216/BD-217



**BD-216**  
125 mm

1/1



**BD-217**  
150 mm

1/1



Pinzette chirurgiche

Tissue forceps

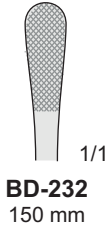
Chirurgische pinzetten

Pinces chirurgicales

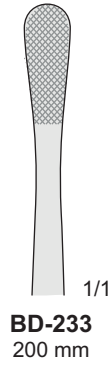
Pinzas quirúrgicas



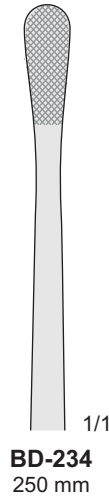
WANGENSTEEN  
BD-232/BD-234



BD-232  
150 mm



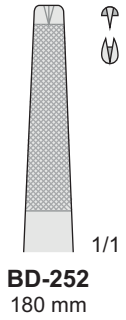
BD-233  
200 mm



BD-234  
250 mm



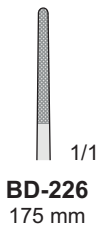
BONNEY  
BD-252  
180 mm



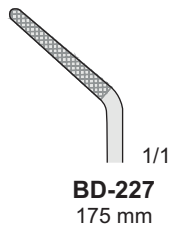
BD-252  
180 mm



CUSHING  
BD-226/BD-227  
175 mm



BD-226  
175 mm

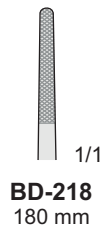


BD-227  
175 mm

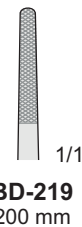
Con dissettore  
With Dissector End  
Mit Dissektor-Ende  
Avec bout disecteur  
Con cabo disecador



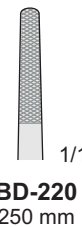
POTTS-SMITH  
BD-218/BD-220



BD-218  
180 mm

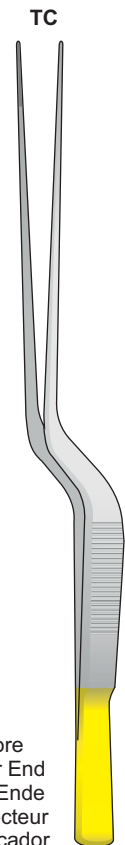


BD-219  
200 mm

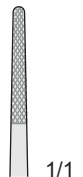


BD-220  
250 mm

Con dissettore  
With Dissector End  
Mit Dissektor-Ende  
Avec bout disecteur  
Con cabo disecador



TAYLOR  
BD-228  
185 mm



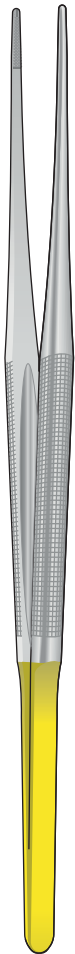
1/1

Con dissettore  
With Dissector End  
Mit Dissektor-Ende  
Avec bout disecteur  
Con cabo disecador



Con punta al carburo di tungsteno  
 Tungsten-carbide forceps  
 Mit hartmetalleinsätzen  
 Avec plaquettes en carbure de tungstène  
 Pinzas con tungsteno

TC

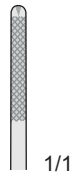


DE BAKEY  
**MF-320**  
 180 mm

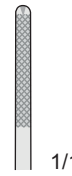
TC



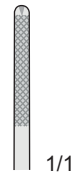
**BD-221/BD-229**



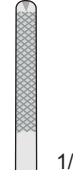
**BD-221**  
 145 mm



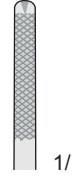
**BD-222**  
 160 mm



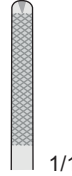
**BD-223**  
 180 mm



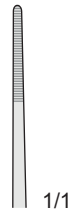
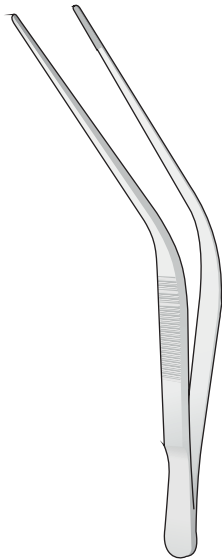
**BD-224**  
 200 mm



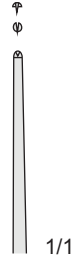
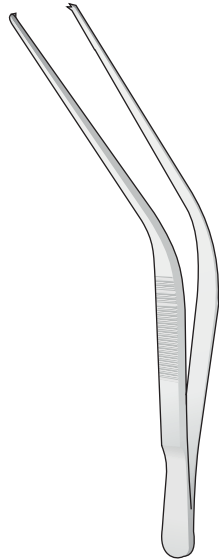
**BD-225**  
 250 mm



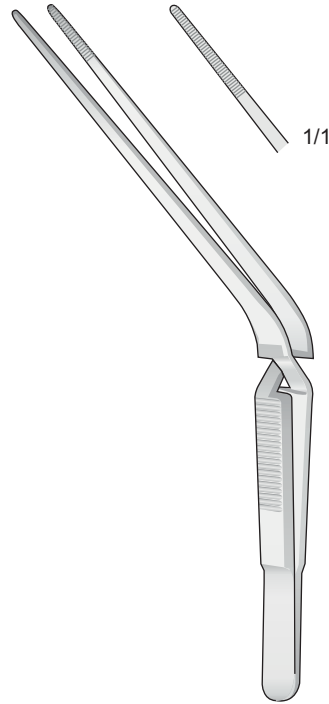
**BD-229**  
 300 mm



TROELTSCH  
BD-22  
110 mm

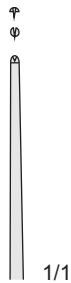


TROELTSCH  
BD-146  
110 mm

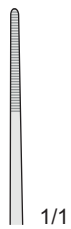
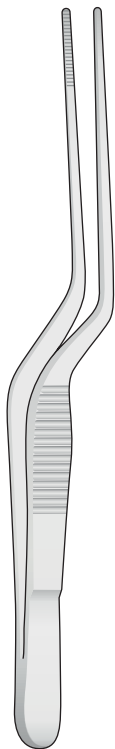


1/1

TROELTSCH  
BD-179  
130 mm



LUCAE  
BD-147  
140 mm



LUCAE  
BD-101  
140 mm



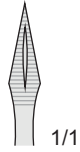
JANSEN  
BD-102  
160 mm



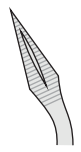
GRÜNWALD  
BD-193  
200 mm



**BD-120**  
105 mm



1/1



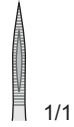
**BD-174**  
105 mm

1/1

HUNTER  
**BD-120/BD-174**



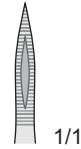
FEICHENFELD  
**BD-121**  
75 mm



1/1



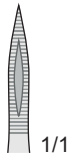
FEICHENFELD  
**BD-122**  
90 mm



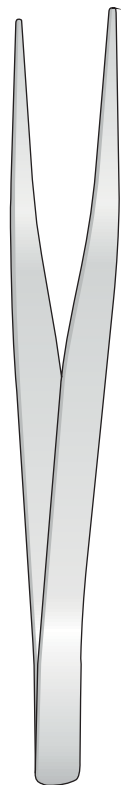
1/1



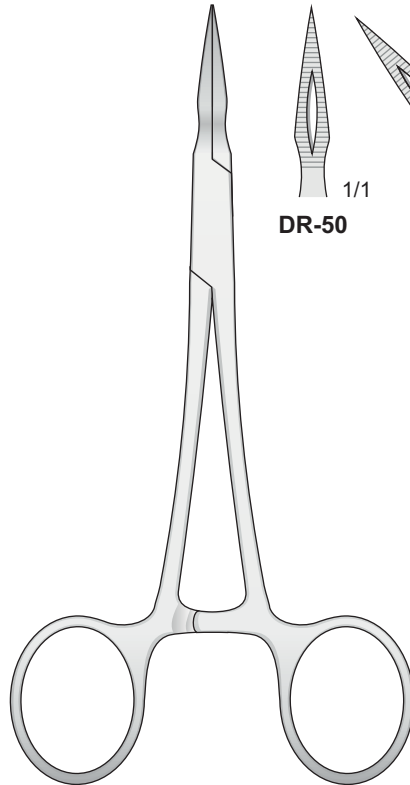
FEICHENFELD  
**BD-123**  
115 mm



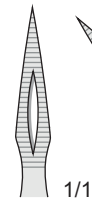
1/1



**BD-50**  
150 mm

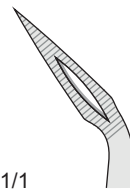


STIEGLITZ  
**DR-50/DR-60**  
140 mm



1/1

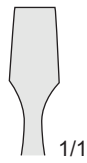
**DR-50**



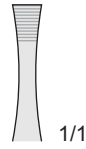
1/1

**DR-60**

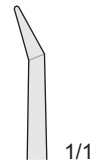




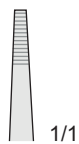
**KÜHNE  
ES-44**  
105 mm



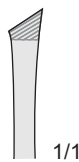
**LITTAUER  
ES-64**  
85 mm



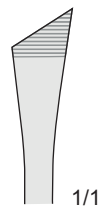
**BARRAQUER  
ES-65**  
105 mm



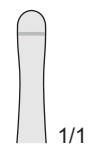
**ES-45**  
90 mm



**ES-46**  
90 mm



**BERGH  
ES-47**  
105 mm



**BEER  
ES-48**  
90 mm





5

Fissateli, Pinze emostatiche  
Towel forceps, Hemostatics forceps  
Tuchklemmen, Arterienklemmen  
Pincès à champs, Pincès hèmostatiques  
Pinzas para campos, Pinzas hemostàticas





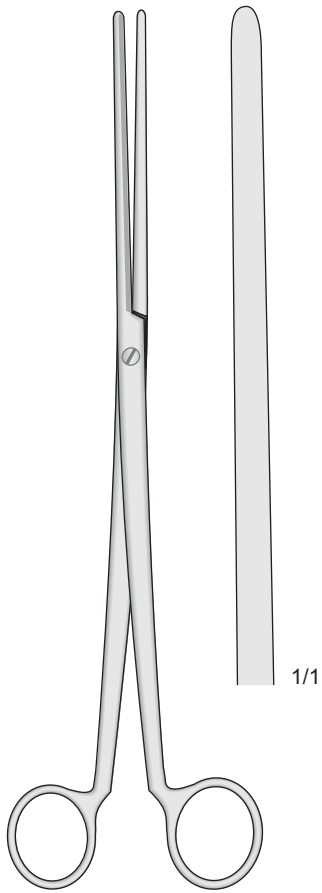
Pinze emostatiche

Hemostatic forceps

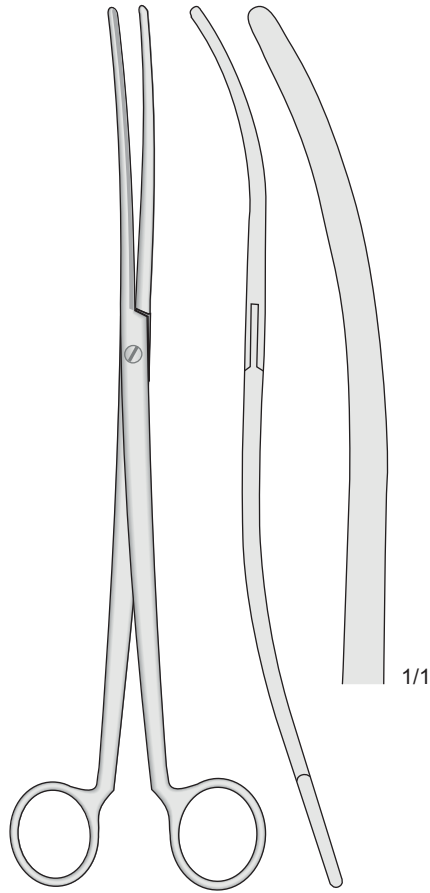
Arterienklemmen

Pinces hémostatiques

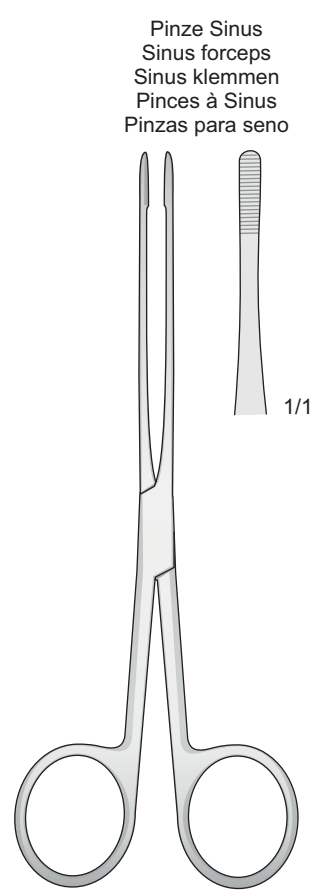
Pinzas hemostáticas



COLLIN  
**BF-03**  
260 mm

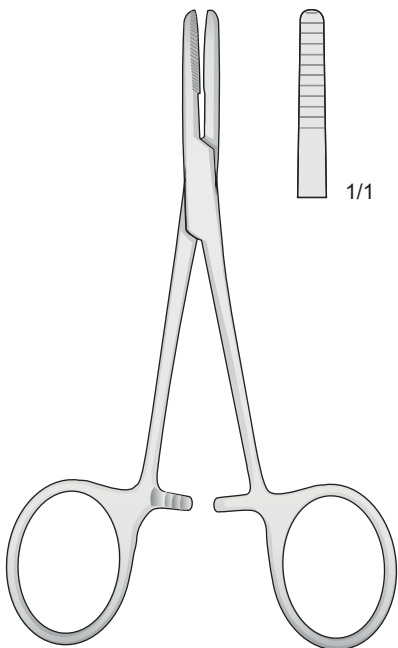


COLLIN  
**BF-04**  
260 mm

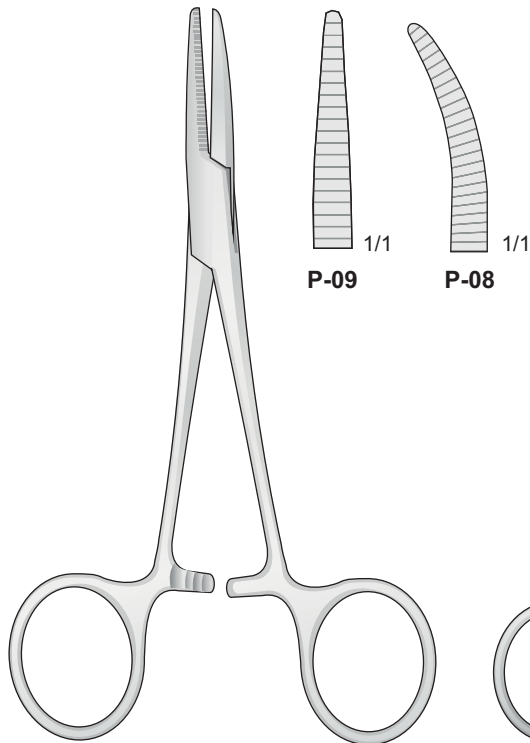


Pinze Sinus  
Sinus forceps  
Sinus klemmen  
Pinces à Sinus  
Pinzas para seno

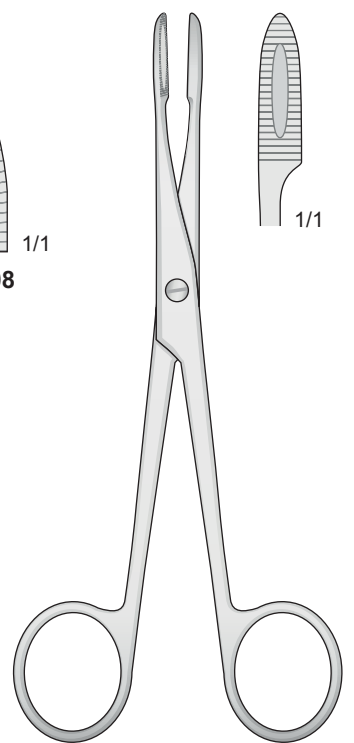
LISTER  
**BF-20**  
150 mm



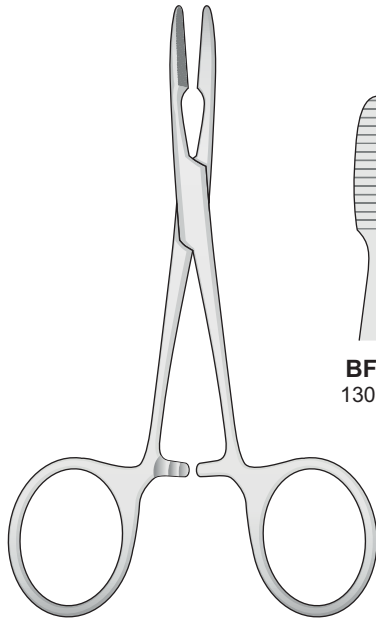
TERRIER  
**P-60**  
130 mm



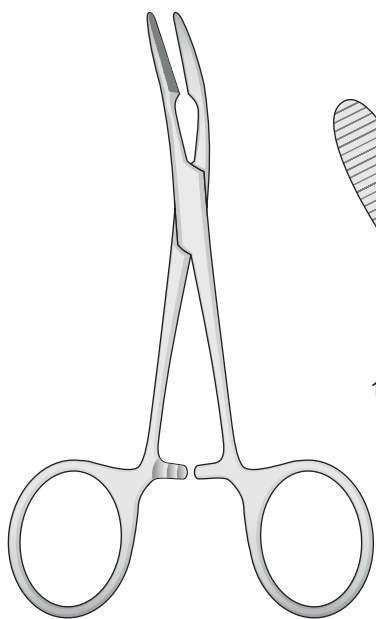
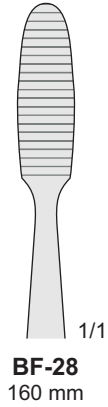
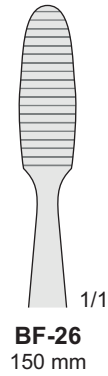
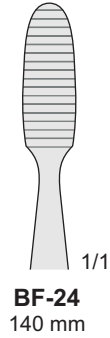
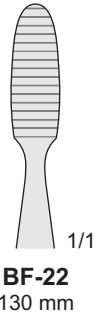
JONES  
**P-09/P-08**  
150 mm



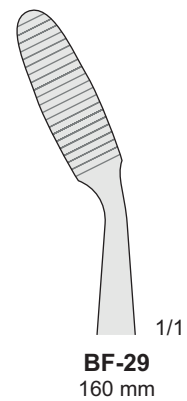
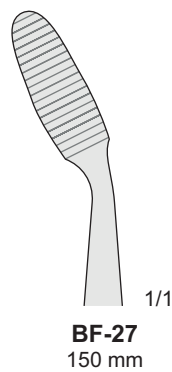
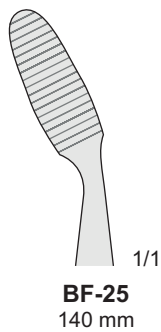
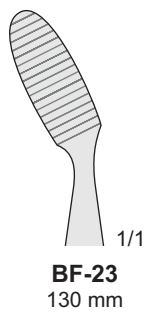
GROSS  
**BF-10** - 130 mm  
**BF-12** - 160 mm

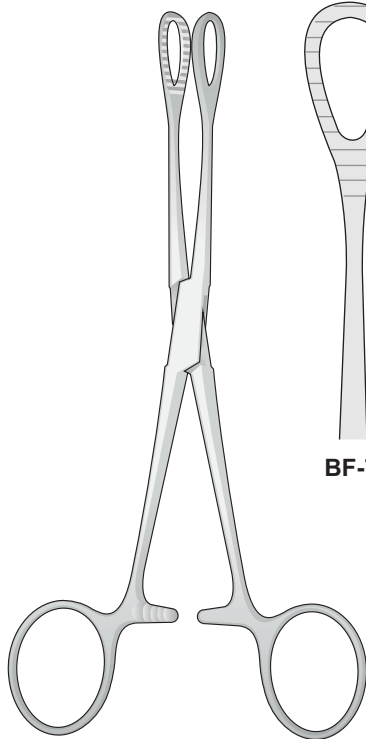


PEAN-MURPHY  
BF-22/BF-28

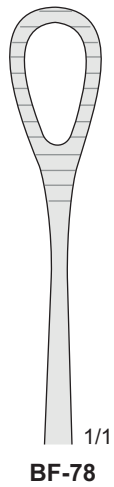


PEAN-MURPHY  
BF-23/BF-29

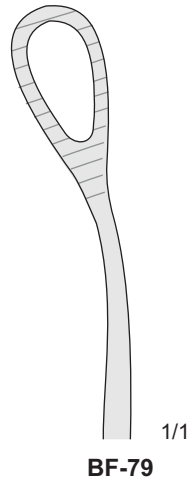




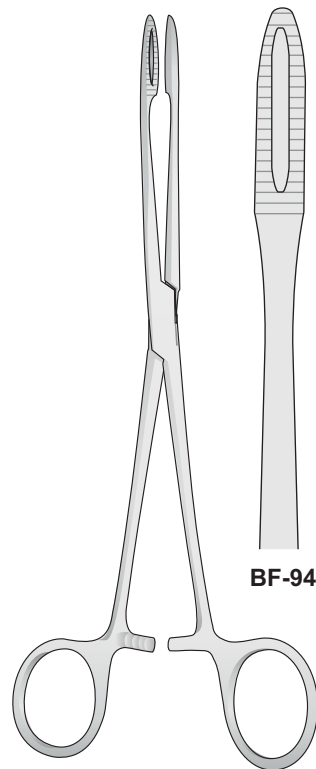
FOERSTER-BALLENGER  
BF-78/BF-79  
180 mm



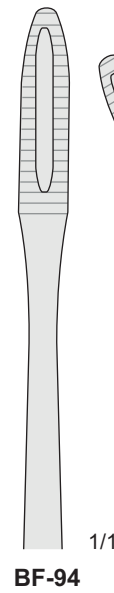
BF-78 1/1



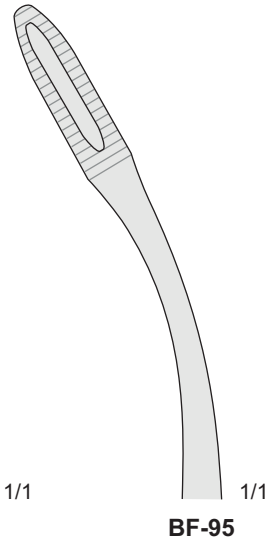
BF-79 1/1



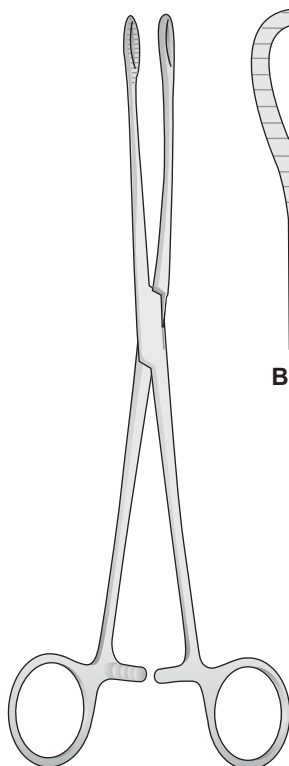
GROSS  
BF-94/BF-95  
200 mm



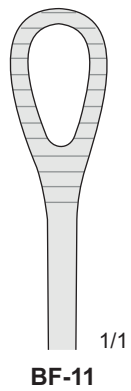
BF-94 1/1



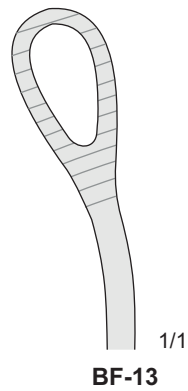
BF-95 1/1



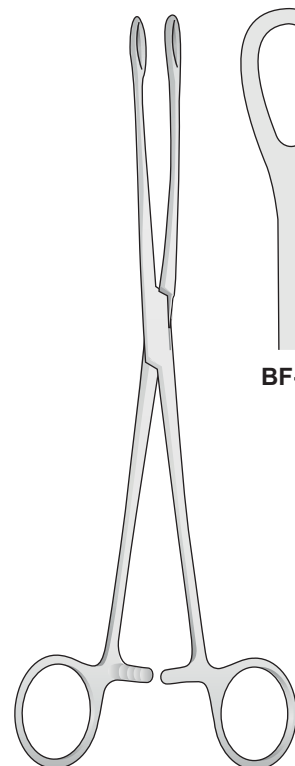
FOERSTER-BALLENGER  
BF-11/BF-13  
240 mm



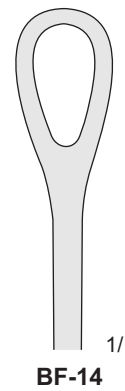
BF-11 1/1



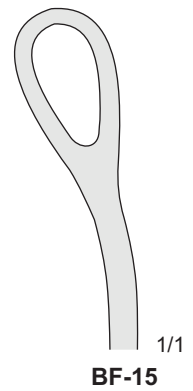
BF-13 1/1



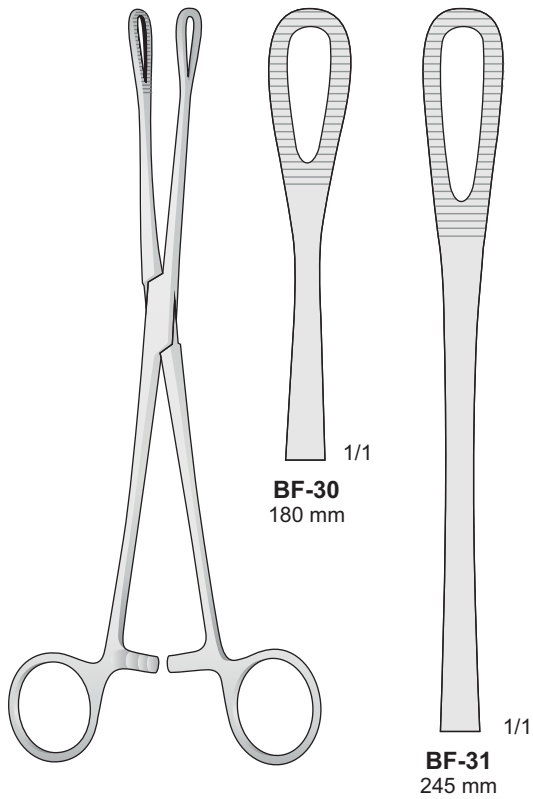
FOERSTER-BALLENGER  
BF-14/BF-15  
240 mm



BF-14 1/1



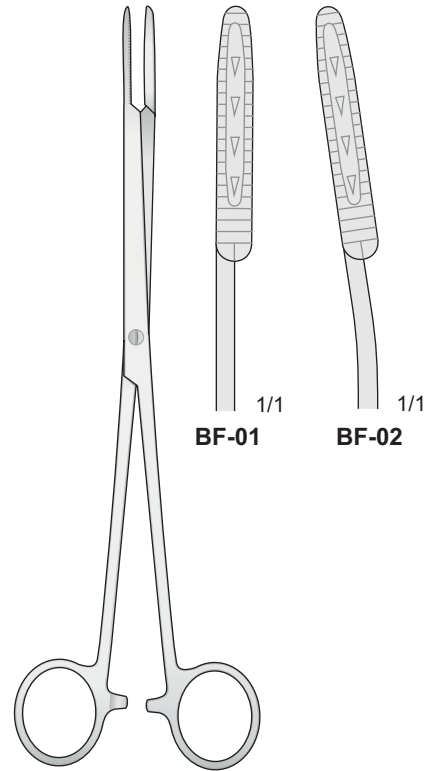
BF-15 1/1



RAMPLEY  
BF-30/BF-31

BF-30  
180 mm

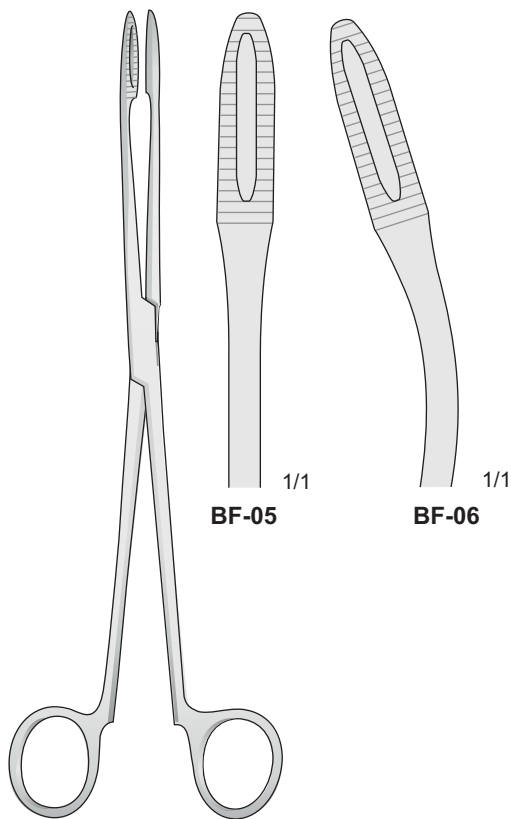
BF-31  
245 mm



MAIER  
BF-01/BF-02  
245 mm

BF-01

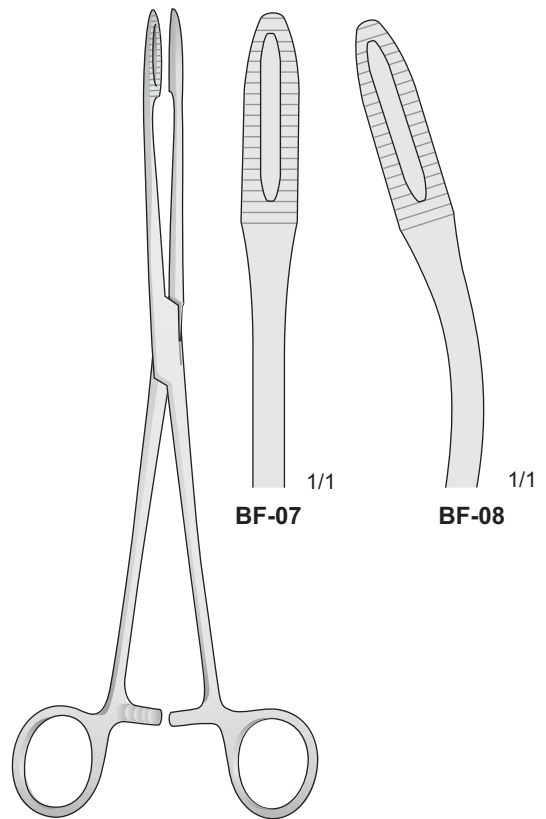
BF-02



MAIER  
BF-05/BF-06  
265 mm

BF-05

BF-06



MAIER  
BF-07/BF-08  
265 mm

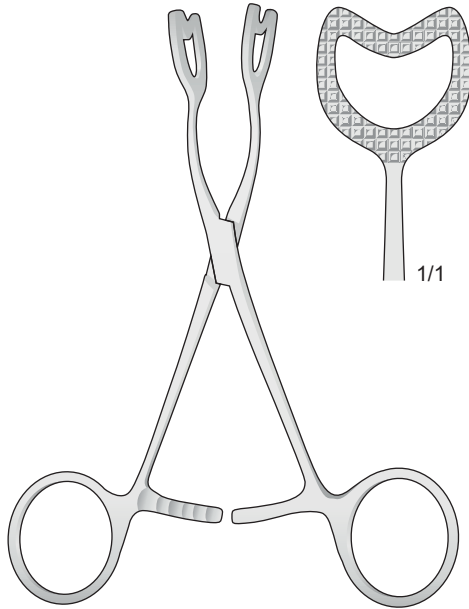
BF-07

BF-08



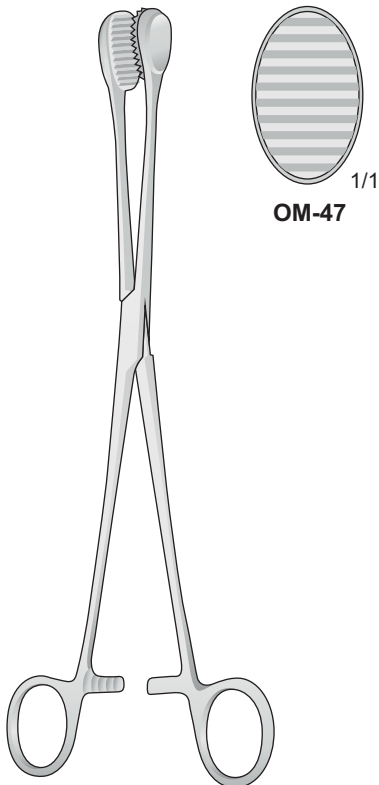


Gommini di ricambio 2 pezzi - Pair, Rubber jaws, only  
Paar, Gummipolster, Allein - Paire, mors en caotchouc, seuls  
Par, Bocas de goma, sueltas

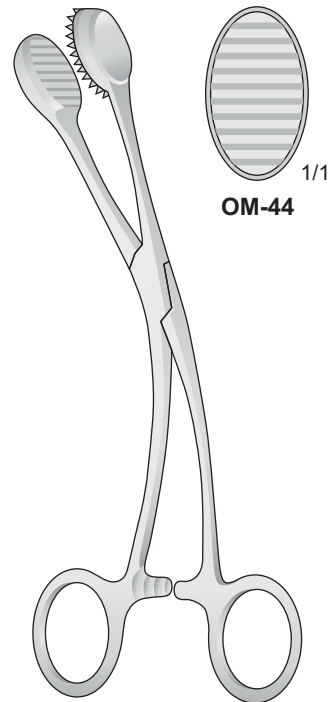


**OM-11**  
140 mm

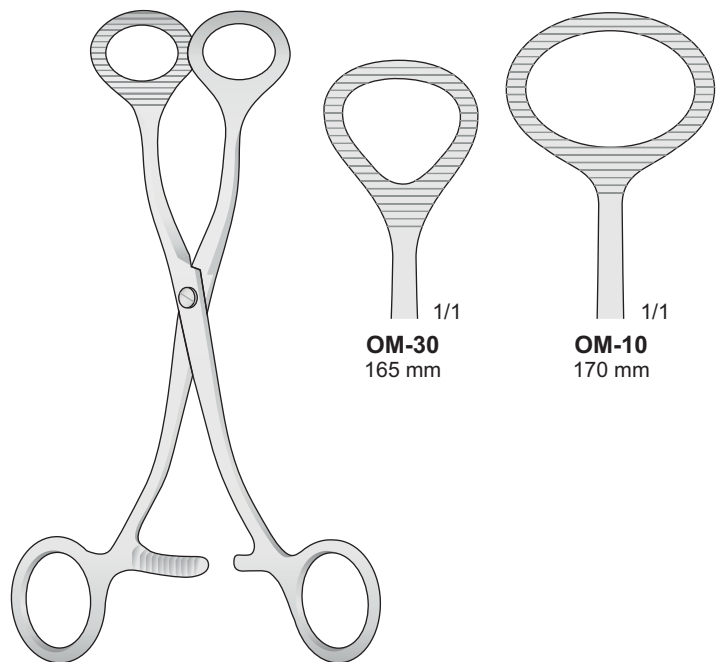
Gommini di ricambio 2 pezzi - Pair, Rubber jaws, only  
Paar, Gummipolster, Allein - Paire, mors en caotchouc, seuls  
Par, Bocas de goma, sueltas



CHILD  
**OM-46**  
240 mm



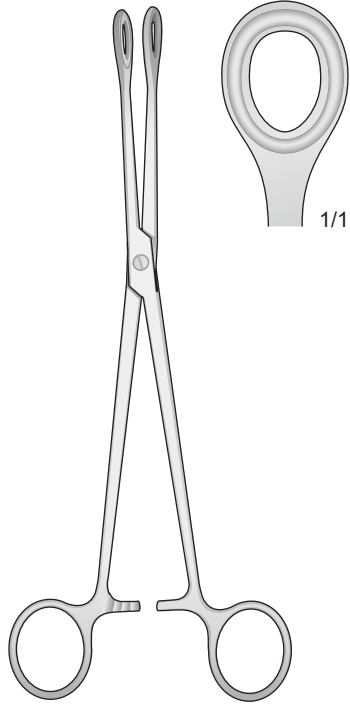
YOUNG  
**OM-45**  
160 mm



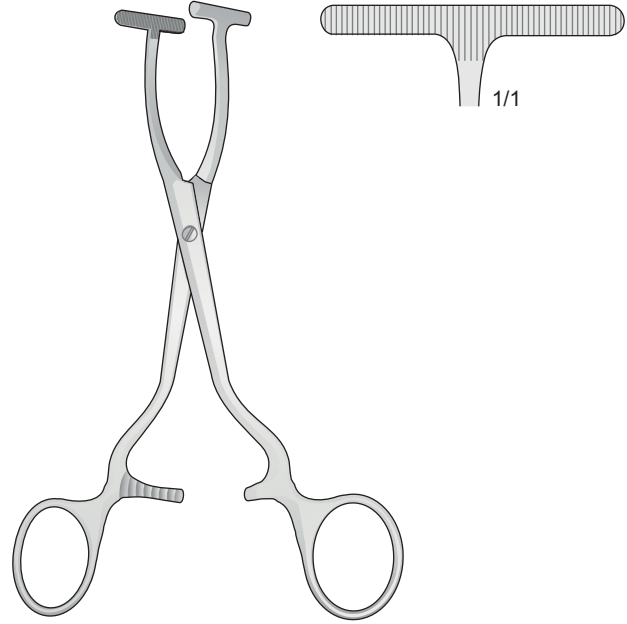
COLLIN  
**OM-10/OM-30**



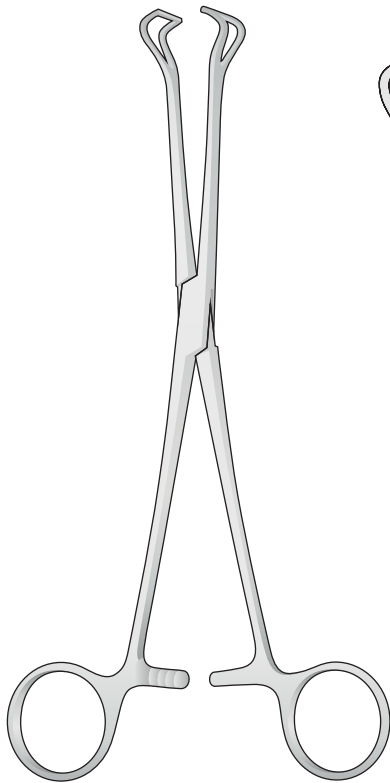
Pinza per batuffoli e tamponi  
Cotton swab-sponge holding forceps  
Tupfer-Schwammzangen - Pinces à tampons et éponges  
Pinzas para tampones porta esponjas



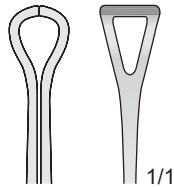
**BF-16**  
230 mm



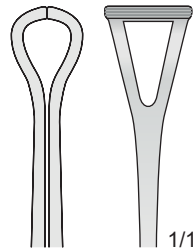
**P-207**  
150 mm



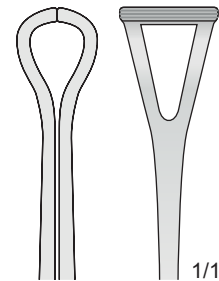
**BABCOCK**  
**P-103/P-126**



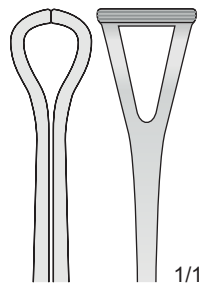
**P-103**  
155 mm



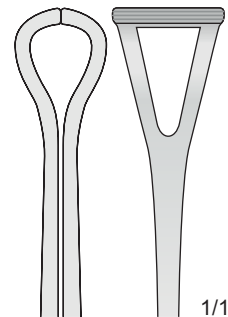
**P-113**  
180 mm



**P-114**  
240 mm



**P-124**  
260 mm



**P-126**  
300 mm



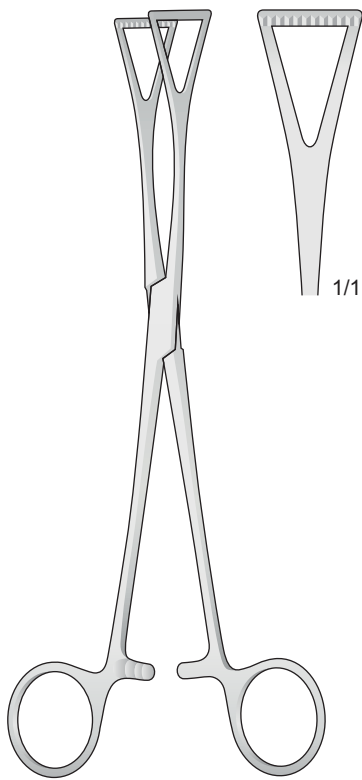
Pinze per afferrare i tessuti

Gum and tissue forceps

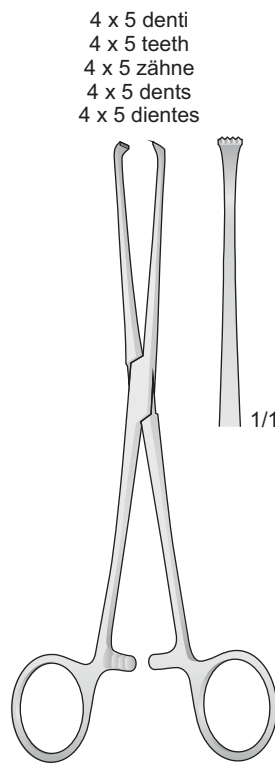
Gewebe und organ Fasszangen

Pinces pour saisir les tissue

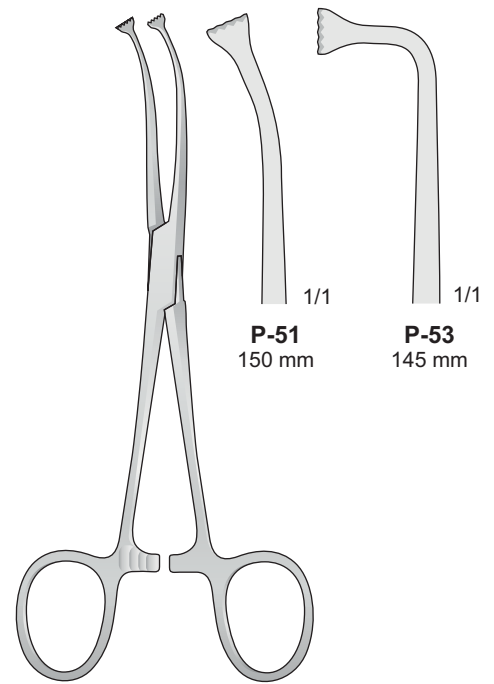
Pinzas para coger las encias



DUVAL  
P-99  
185 mm

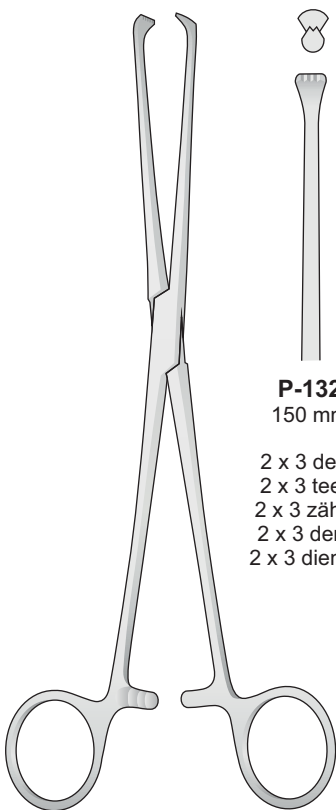


BABY-ALLIS  
P-100  
130 mm

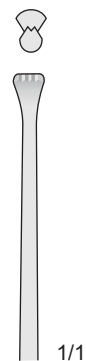


ALLIS  
P-51/P-53

4 x 5 denti  
4 x 5 teeth  
4 x 5 zähne  
4 x 5 dents  
4 x 5 dientes

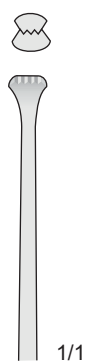


ALLIS  
P-50/P-118



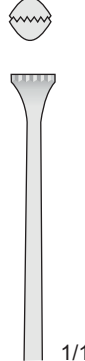
P-132  
150 mm

2 x 3 denti  
2 x 3 teeth  
2 x 3 zähne  
2 x 3 dents  
2 x 3 dientes



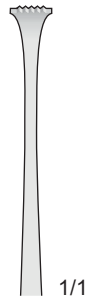
P-133  
150 mm

3 x 4 denti  
3 x 4 teeth  
3 x 4 zähne  
3 x 4 dents  
3 x 4 dientes



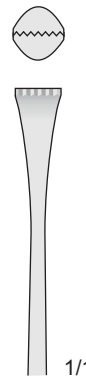
P-134  
150 mm

4 x 5 denti  
4 x 5 teeth  
4 x 5 zähne  
4 x 5 dents  
4 x 5 dientes



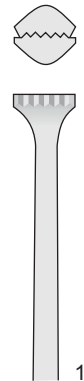
P-50  
160 mm

5 x 6 denti  
5 x 6 teeth  
5 x 6 zähne  
5 x 6 dents  
5 x 6 dientes



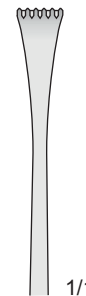
P-115  
200 mm

5 x 6 denti  
5 x 6 teeth  
5 x 6 zähne  
5 x 6 dents  
5 x 6 dientes



P-119  
220 mm

5 x 6 denti  
5 x 6 teeth  
5 x 6 zähne  
5 x 6 dents  
5 x 6 dientes



P-118  
250 mm

5 x 6 denti  
5 x 6 teeth  
5 x 6 zähne  
5 x 6 dents  
5 x 6 dientes



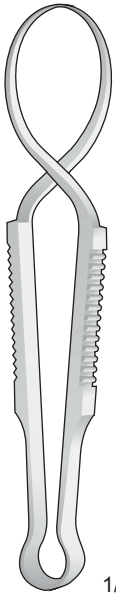
Fissateli

Towel clamps

Tuchklemmen

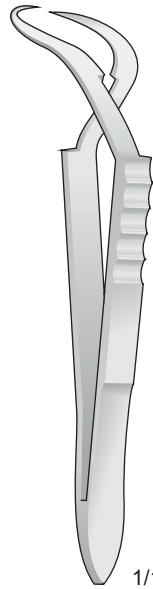
Pinces pour fixer les compresses

Pinzas de campo



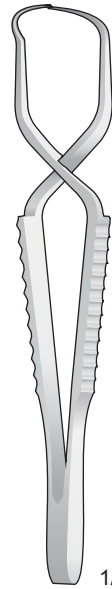
1/1

SCHAEDEL  
BF-38  
85 mm



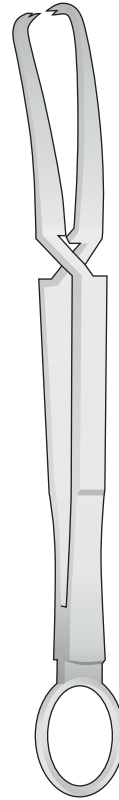
1/1

JONES  
BF-48  
90 mm



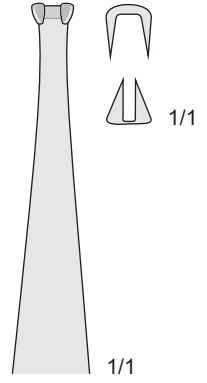
1/1

FAURE  
BF-40  
85 mm

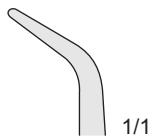


1/1

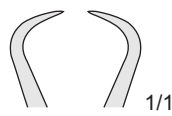
DOYEN  
BF-36  
180 mm



1/1

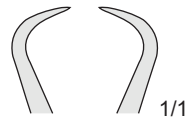


1/1



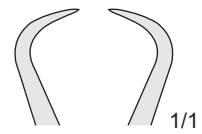
1/1

BF-42  
90 mm



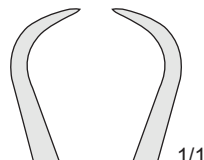
1/1

BF-41  
100 mm



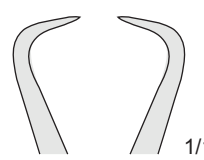
1/1

BF-44  
110 mm



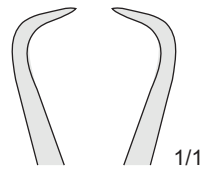
1/1

BF-46  
130 mm



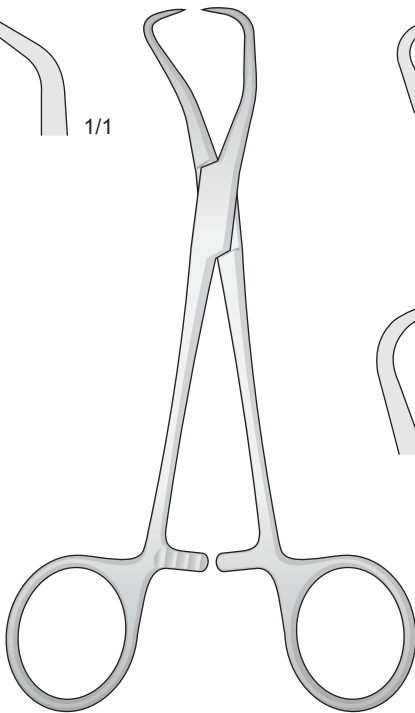
1/1

BF-43  
135 mm



1/1

BF-45  
140 mm



BACKHAUS  
BF-42/BF-46



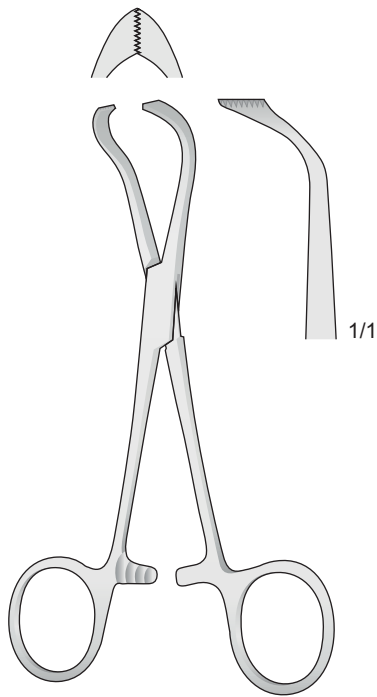
Fissateli

Towel clamps

Tuchklemmen

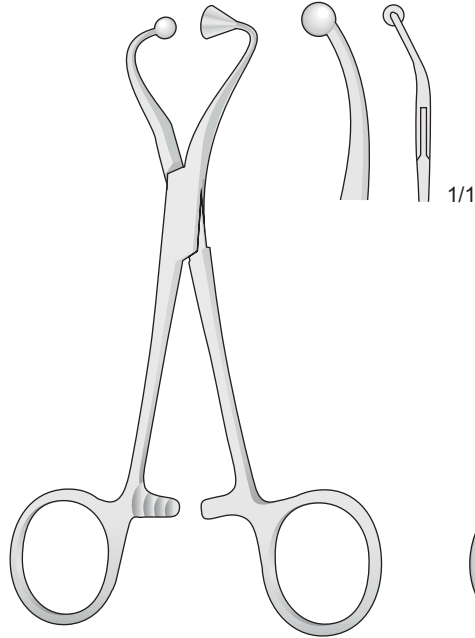
Pinces pour fixer les compresses

Pinzas de campo



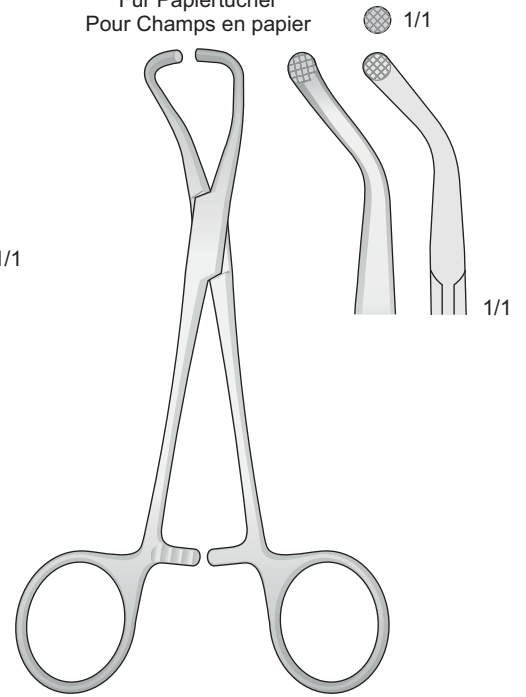
LORNA  
BF-50  
100 mm

Per teli di carta  
For paper cloths  
Für Papiertücher  
Pour Champs en papier



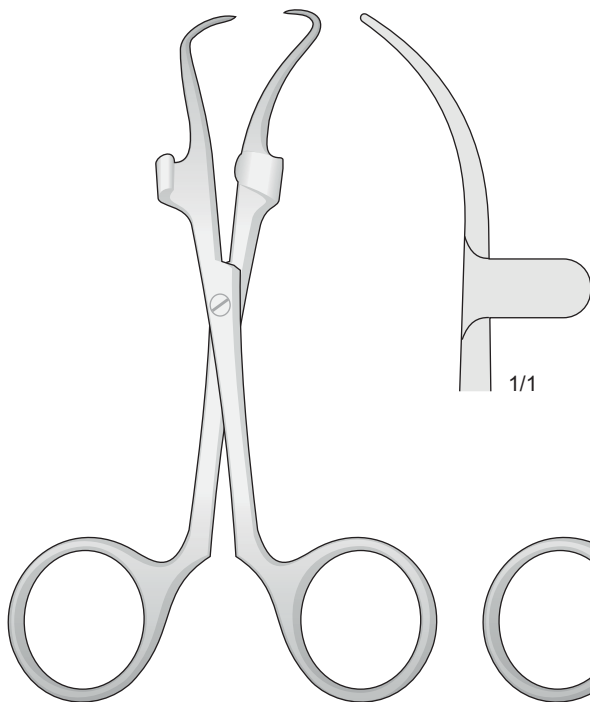
BF-74  
115 mm

Per teli di carta  
For paper cloths  
Für Papiertücher  
Pour Champs en papier

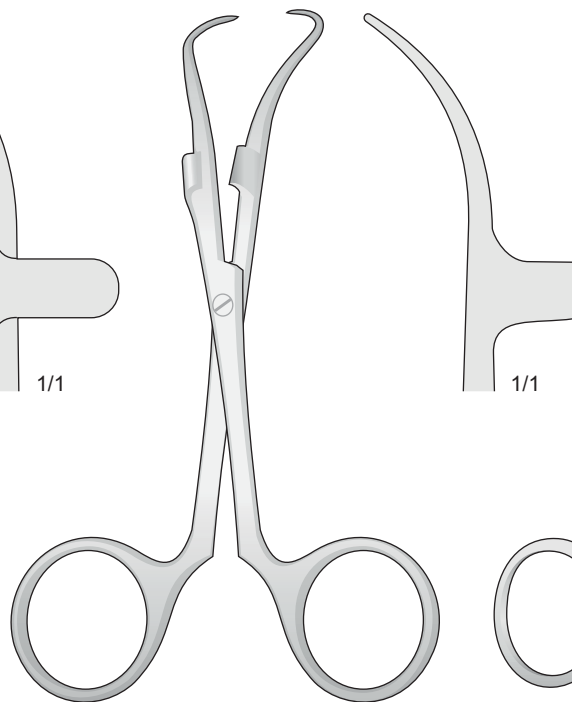


BF-52  
130 mm

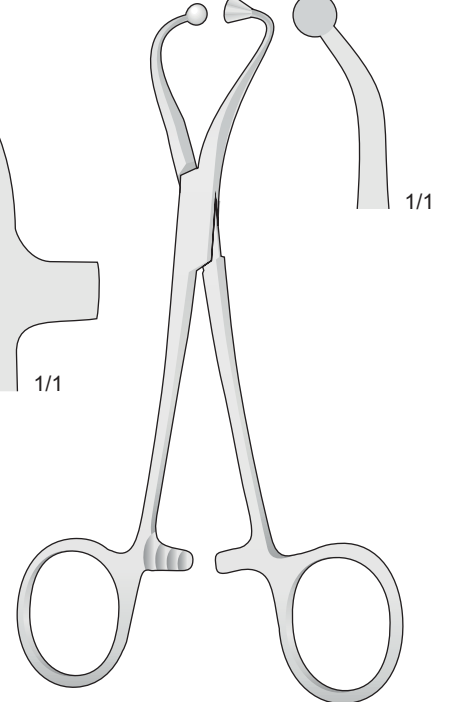
Per teli di carta  
For paper cloths  
Für Papiertücher  
Pour Champs en papier



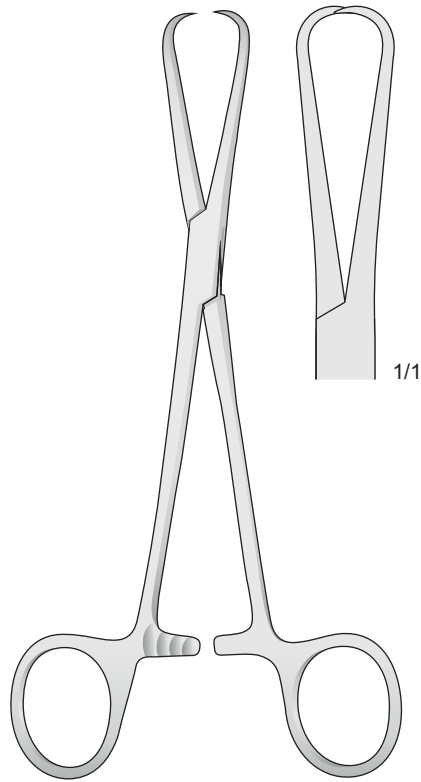
ROBIN  
BF-72  
140 mm



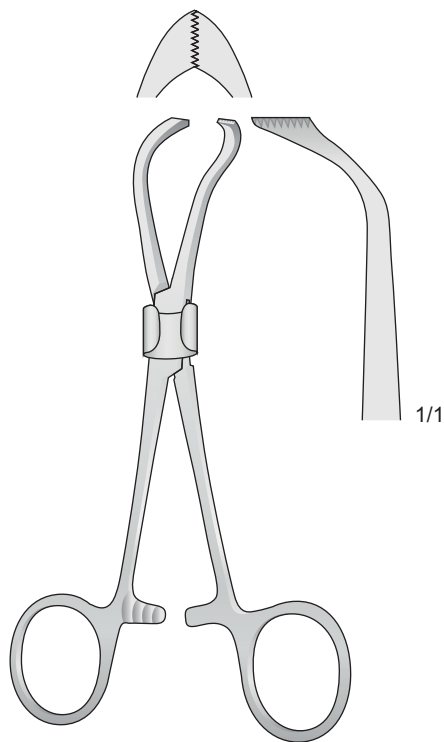
ROBIN  
BF-73  
140 mm



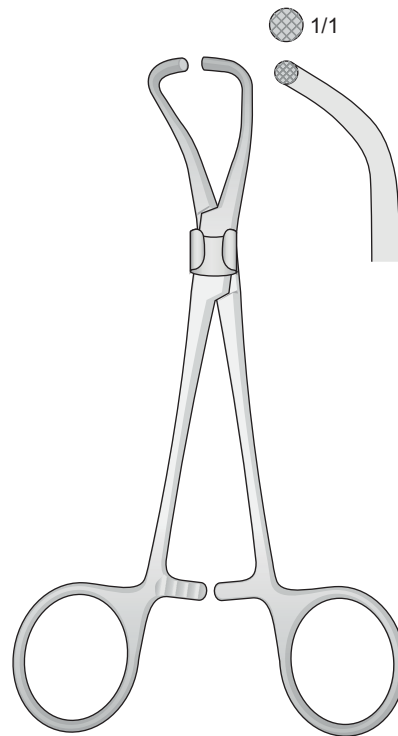
BF-75  
140 mm



BERNHARD  
**BF-82**  
165 mm



**BF-85** Ø 9 mm    **BF-86** Ø 12 mm  
**BF-87** Ø 14 mm    **BF-88** Ø 17 mm  
100 mm



**BF-90** Ø 9 mm    **BF-91** Ø 12 mm  
**BF-92** Ø 14 mm    **BF-93** Ø 17 mm  
130 mm



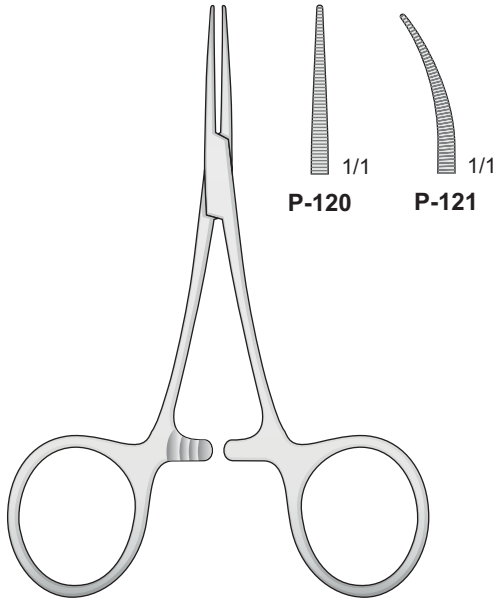
Pinze emostatiche  
delicate

Fine  
Artery forceps

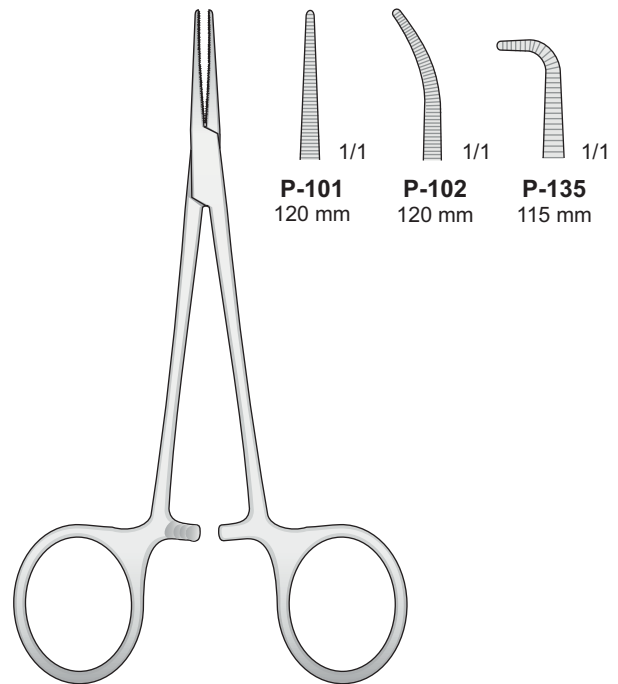
Fine-Arterienklemmen

Delicate  
Pincers hémostatiques

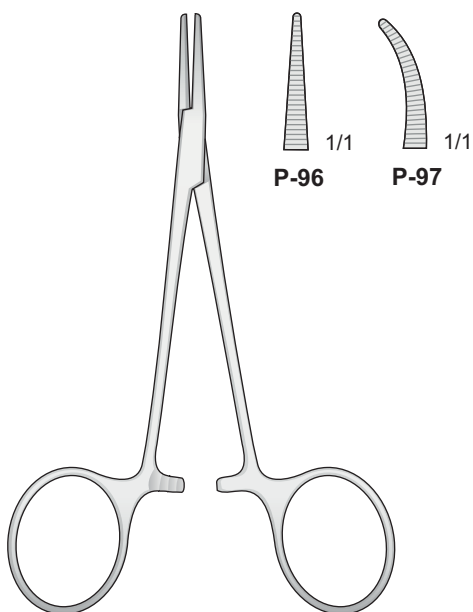
Pinzas hemostáticas  
fino



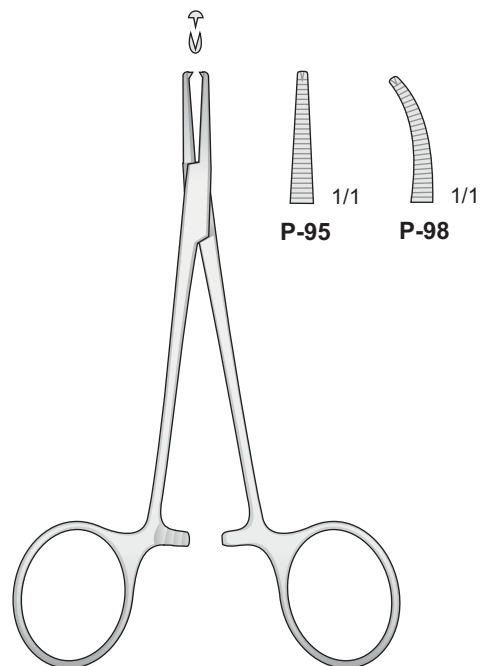
HARTMANN-BABY-MOSQUITO  
P-120/P-121  
95 mm



MICRO-HALSTED  
P-101/P-135



HALSTED-MOSQUITO  
P-96/P-97  
120 mm



HALSTED-MOSQUITO  
P-95/P-98  
120 mm



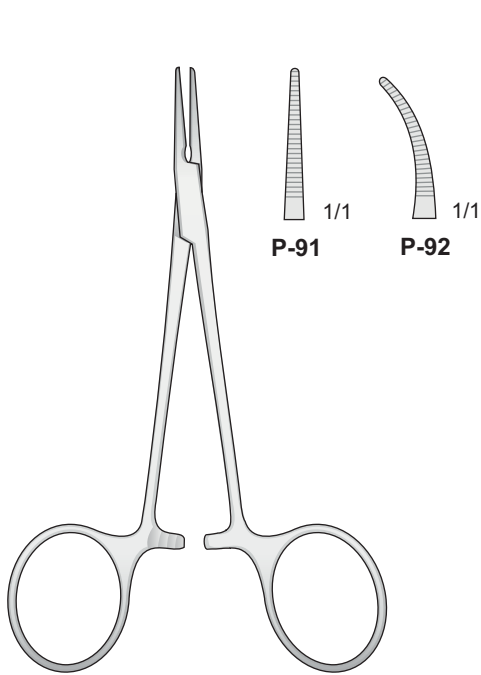
Pinze emostatiche  
delicate

Fine  
Artery forceps

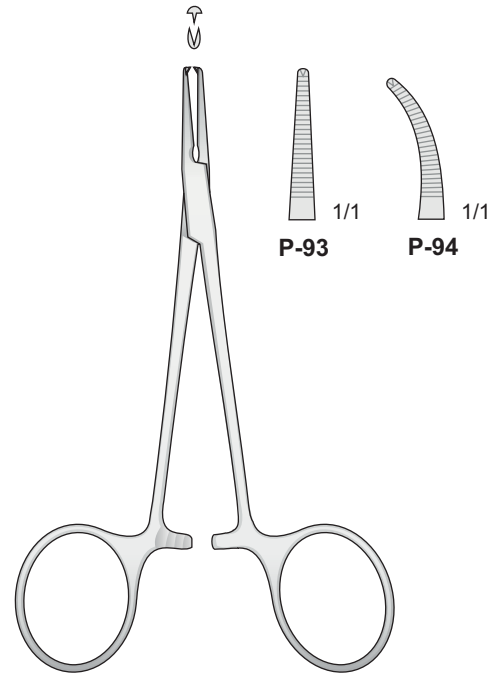
Fine-Arterienklemmen

Delicate  
Pincès hémostatiques

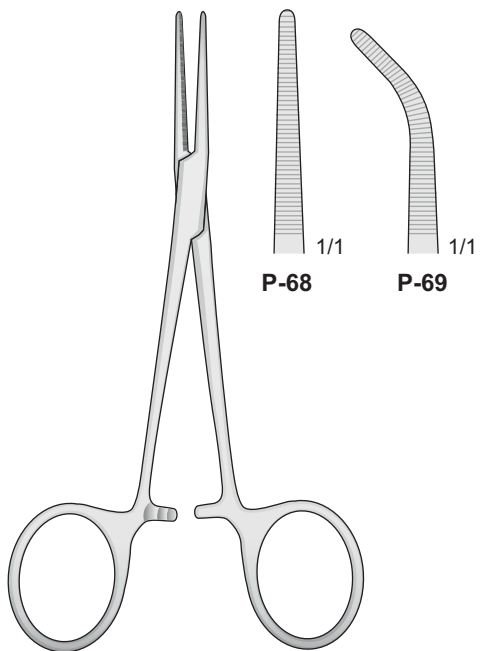
Pinzas hemostáticas  
fino



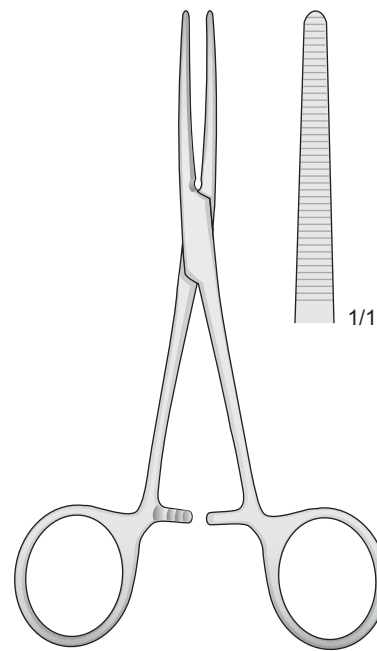
HALSTED  
P-91/P-92  
125 mm



HALSTED  
P-93/P-94  
125 mm

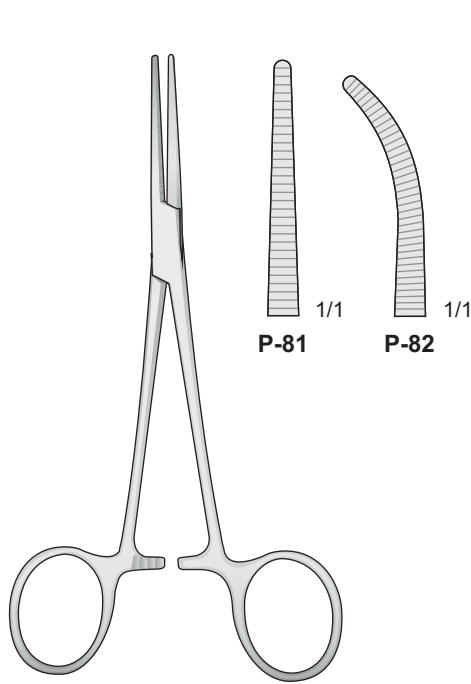


GIDEF  
P-68/P-69  
140 mm

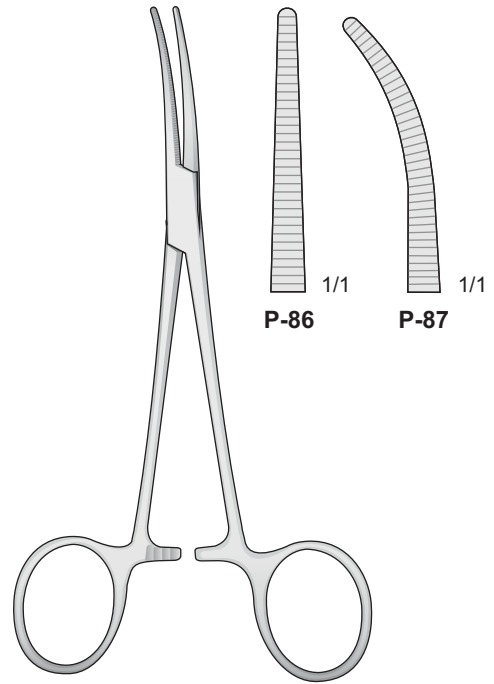


PEAN  
P-17  
140 mm



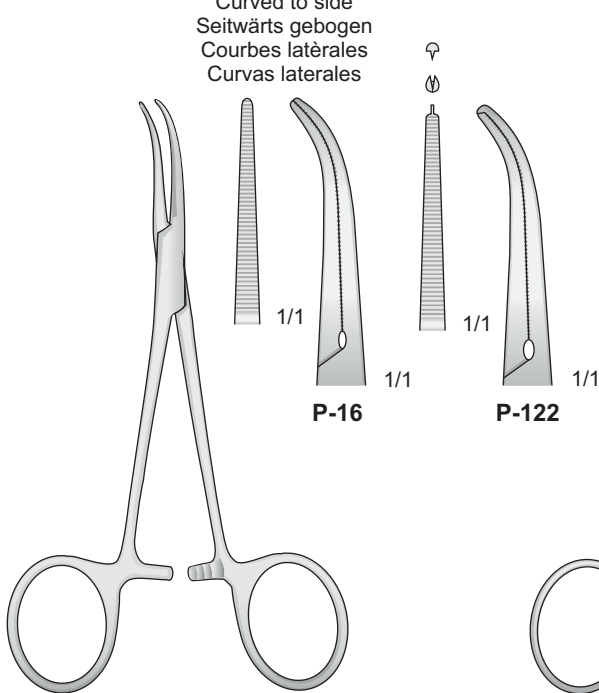


CRILE  
P-81/P-82  
140 mm

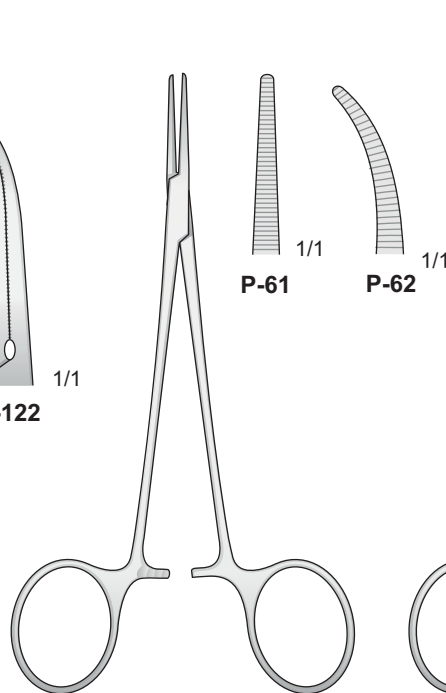


CRILE  
P-86/P-87  
160 mm

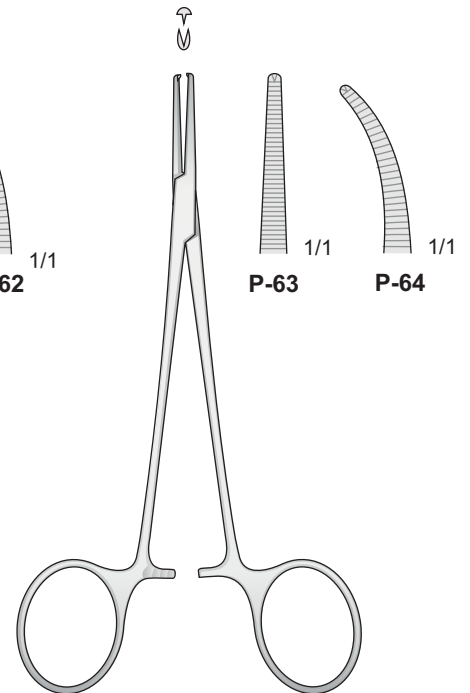
Curve sul lato  
Curved to side  
Seitwärts gebogen  
Courbes latérales  
Curvas laterales



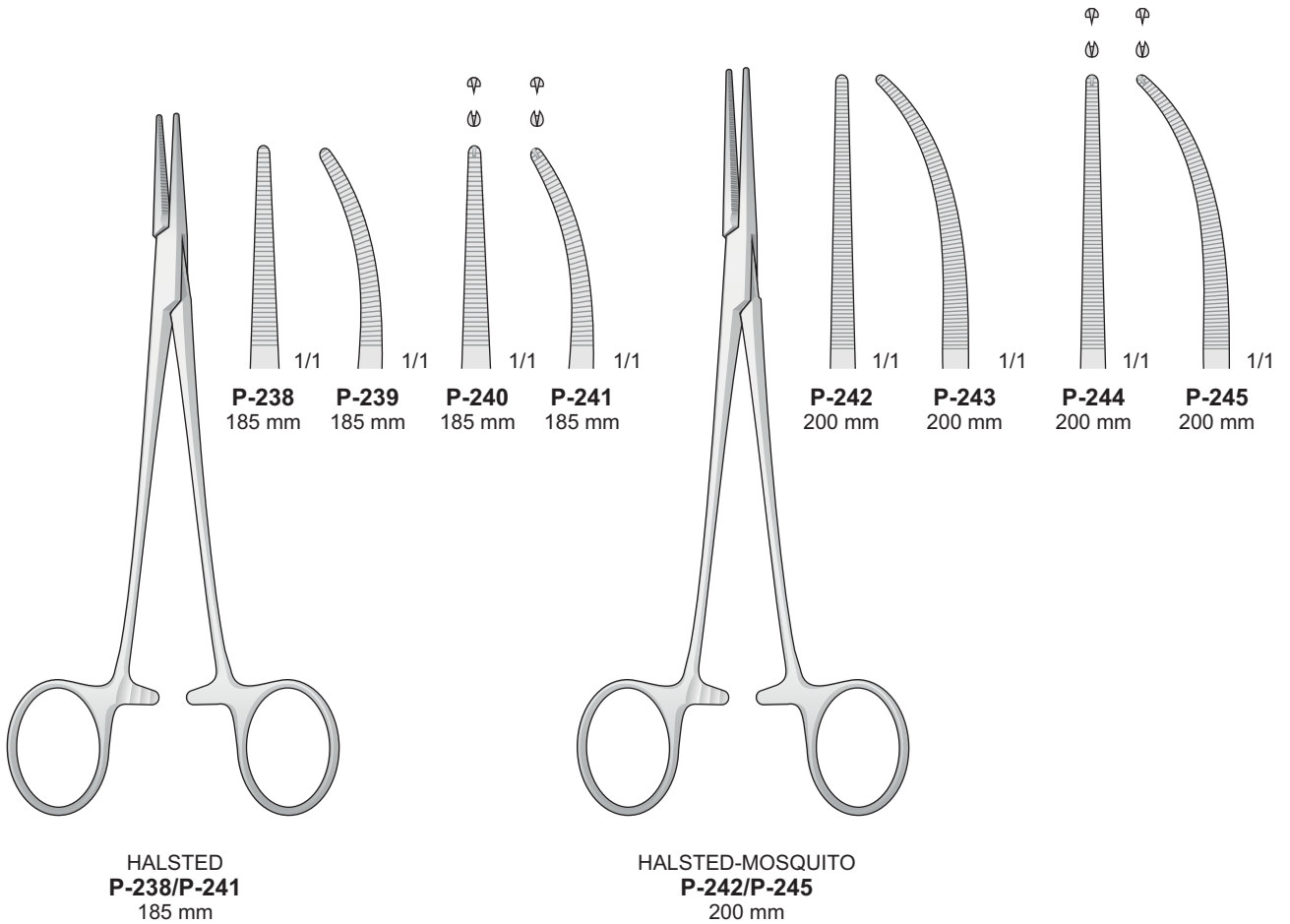
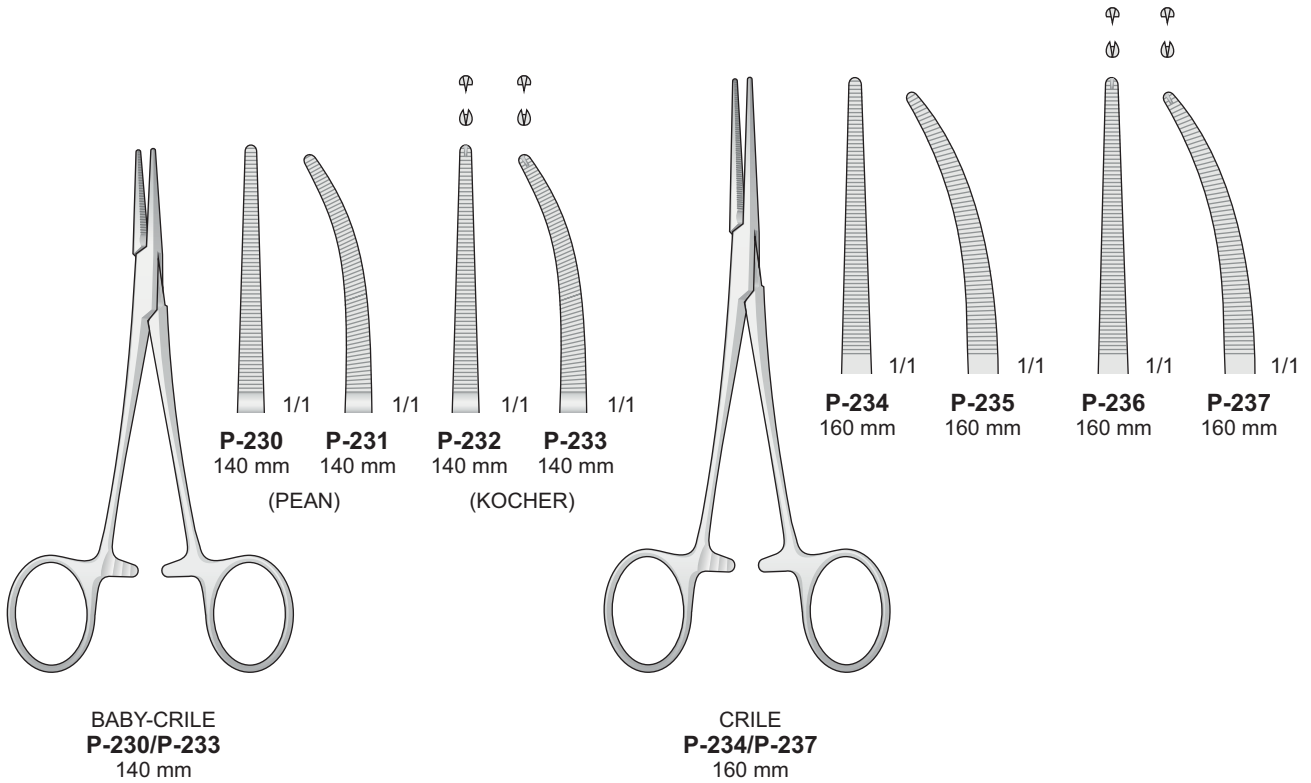
DANDY  
P-16/P-122  
140 mm

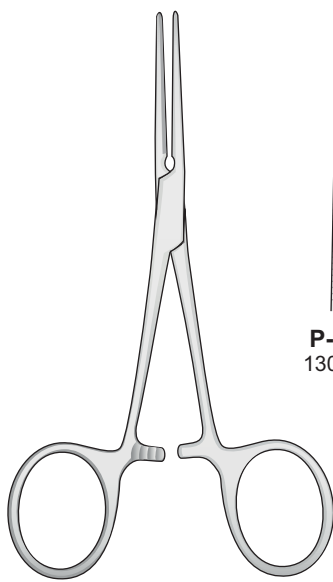


LERICHE  
P-61/P-62  
150 mm

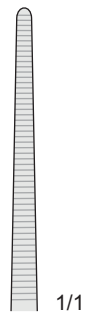


LERICHE  
P-63/P-64  
150 mm

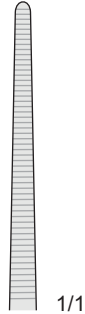




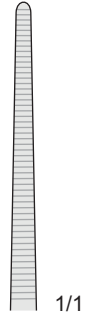
PEAN  
P-250/P-255



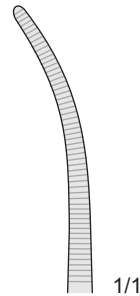
P-250  
130 mm



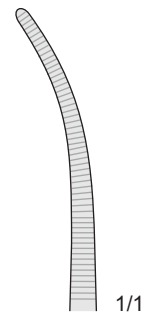
P-252  
140 mm



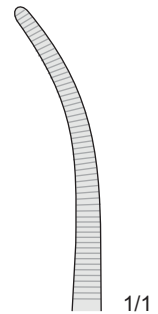
P-254  
140 mm



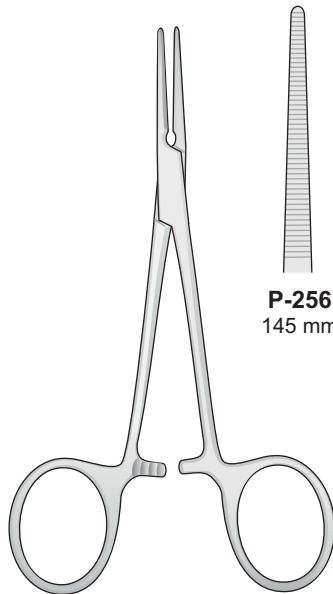
P-251  
130 mm



P-253  
140 mm



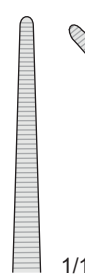
P-255  
140 mm



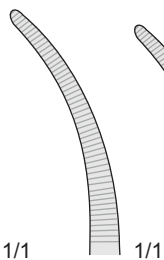
PEAN  
P-256/P-259



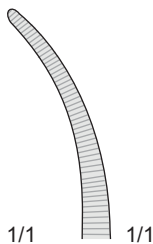
P-256  
145 mm



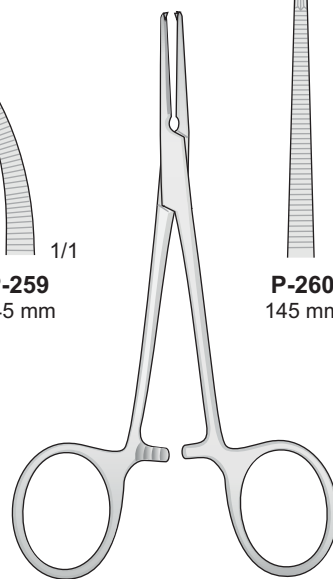
P-258  
145 mm



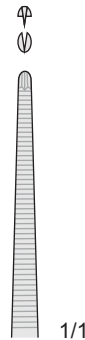
P-257  
145 mm



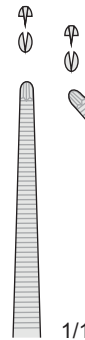
P-259  
145 mm



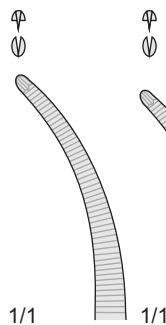
KOCHER  
P-260/P-263



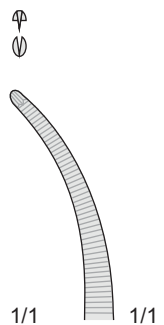
P-260  
145 mm



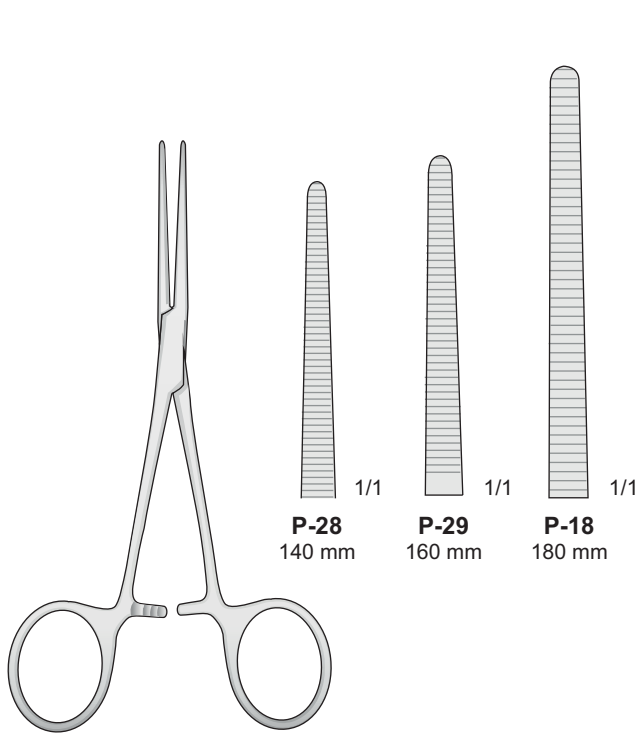
P-262  
145 mm



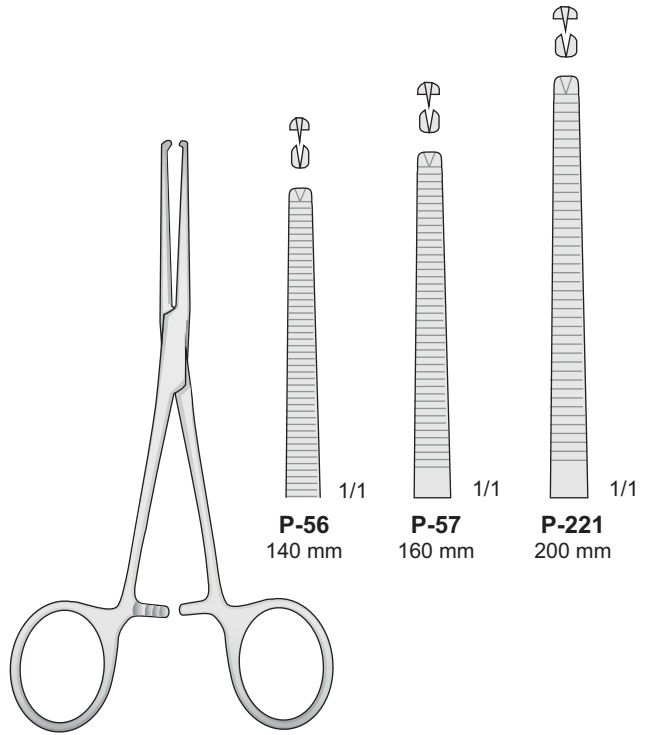
P-261  
145 mm



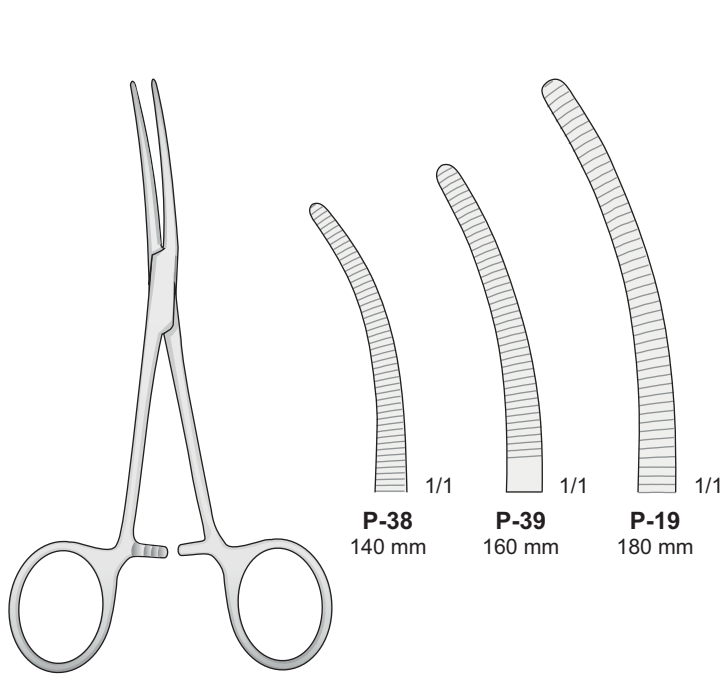
P-263  
145 mm



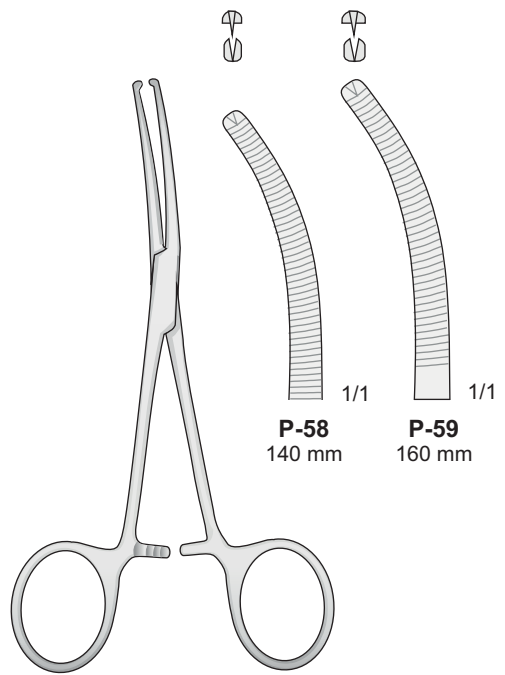
ROCHESTER-PEAN  
P-28/P-18



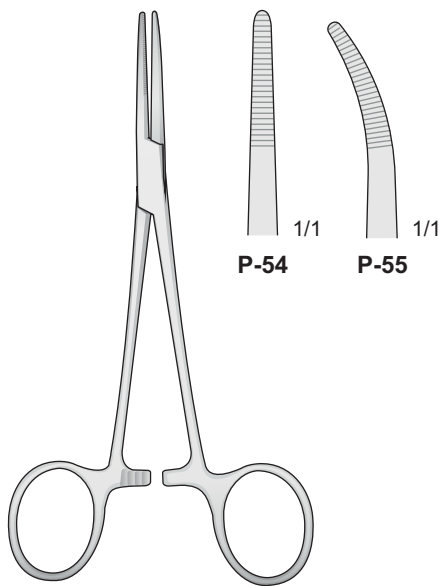
KOCHER-OCHSNER  
P-56/P-221



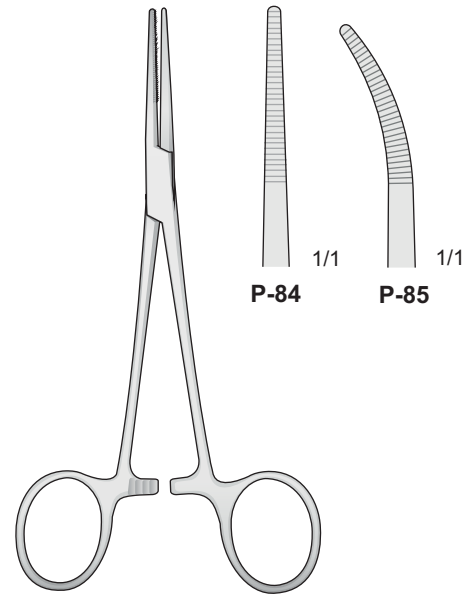
ROCHESTER-PEAN  
P-38/P-19



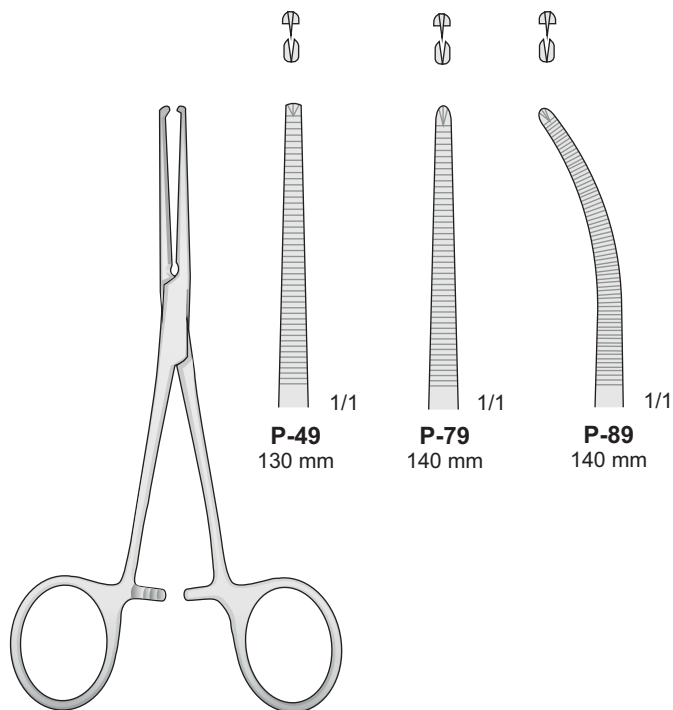
KOCHER-OCHSNER  
P-58/P-59



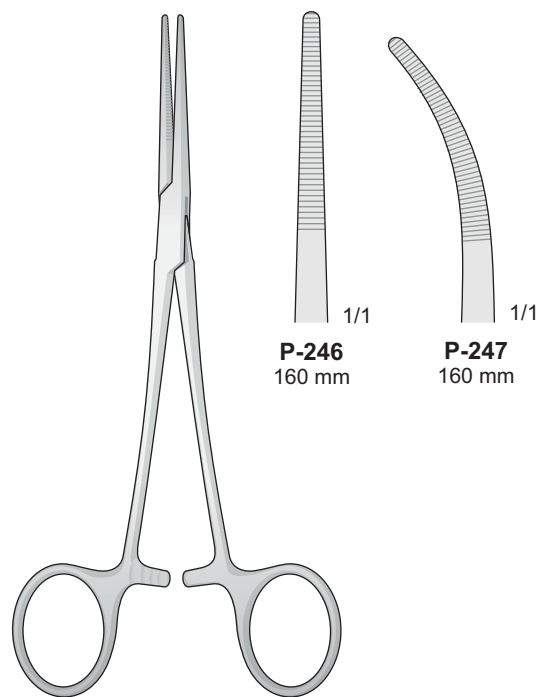
KELLY  
P-54/P-55  
140 mm



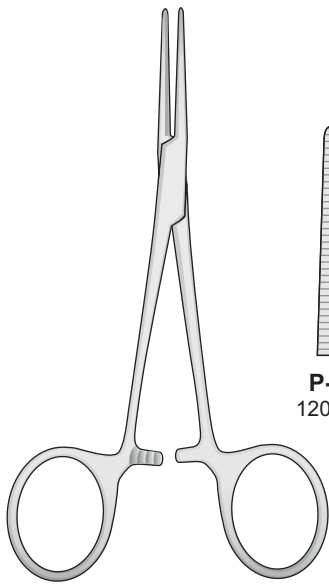
KELLY  
P-84/P-85  
140 mm



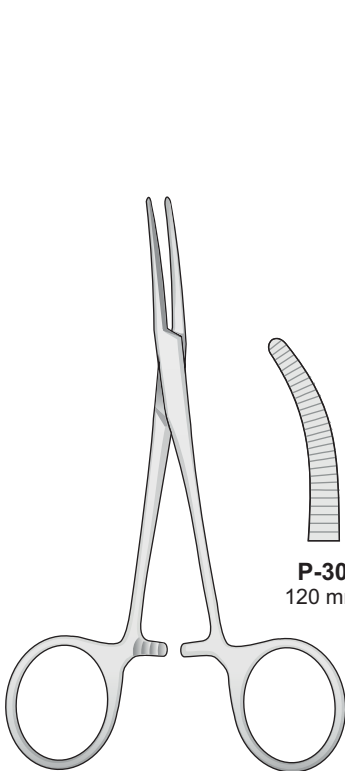
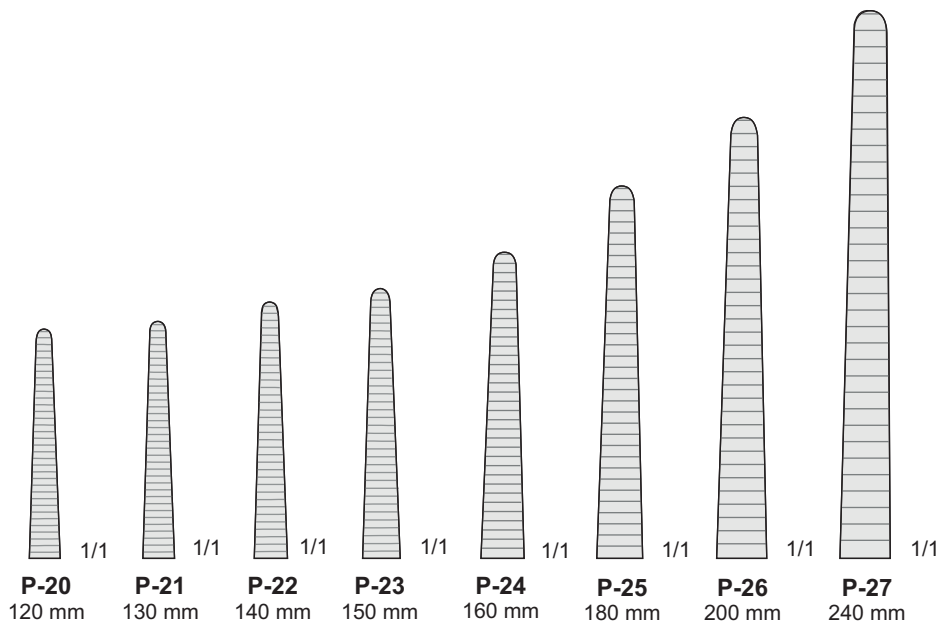
KOCHER  
P-49/P-89



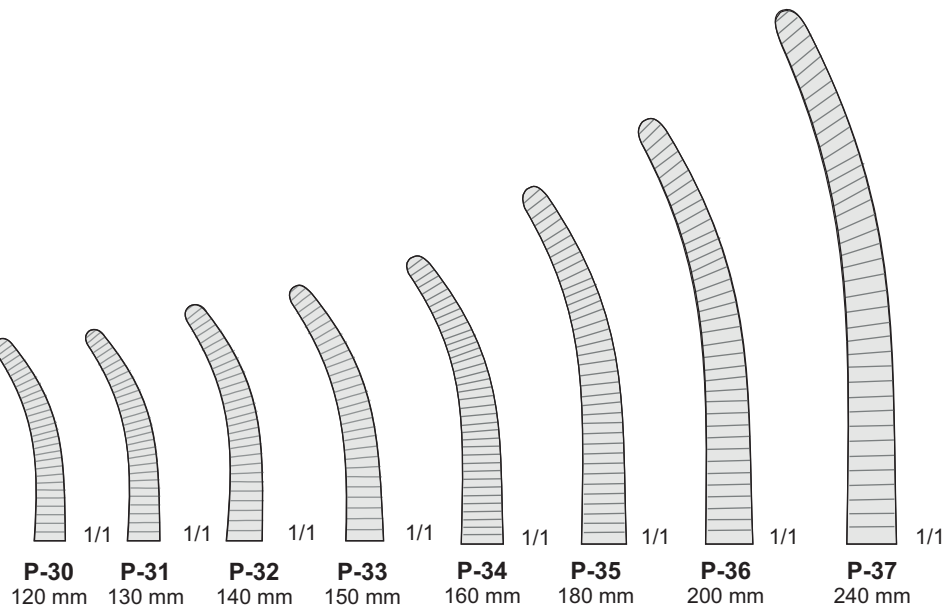
RANKIN  
P-246/P-247

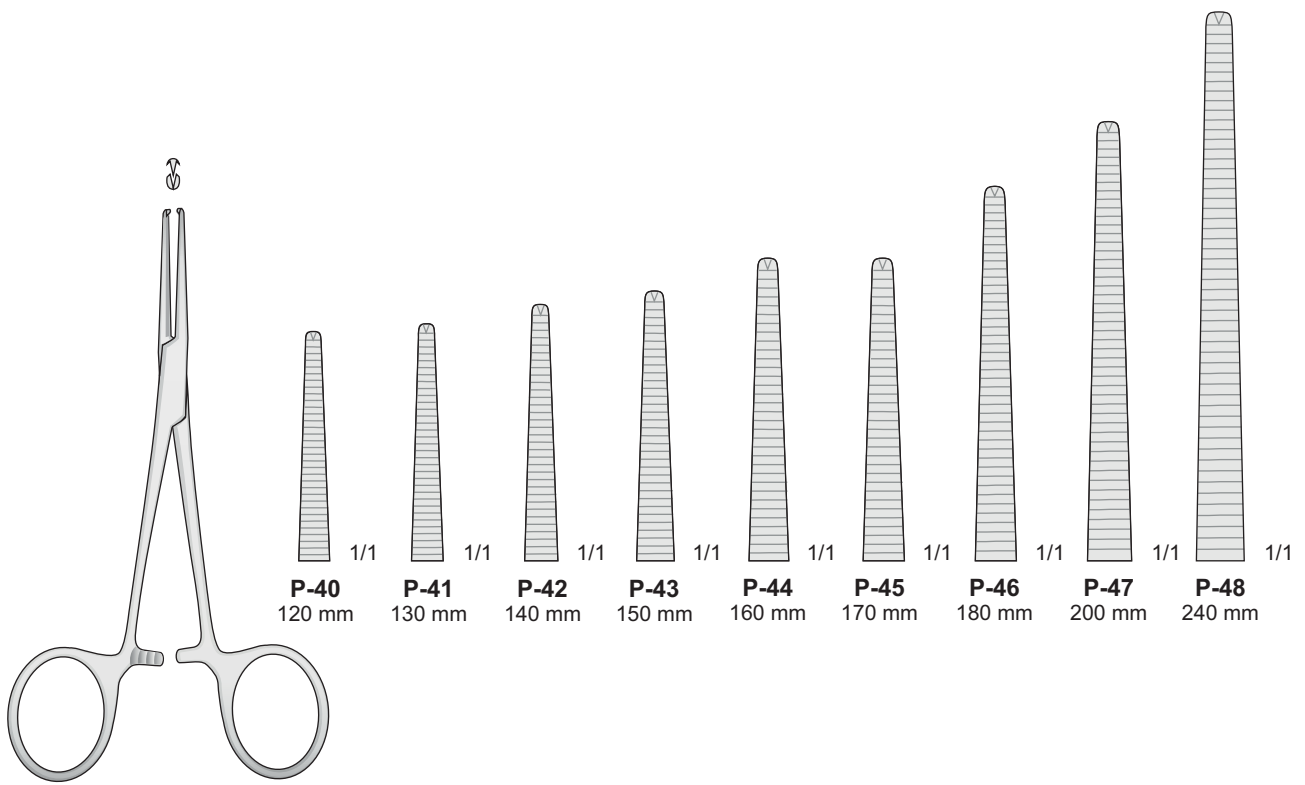


PEAN  
P-20/P-27

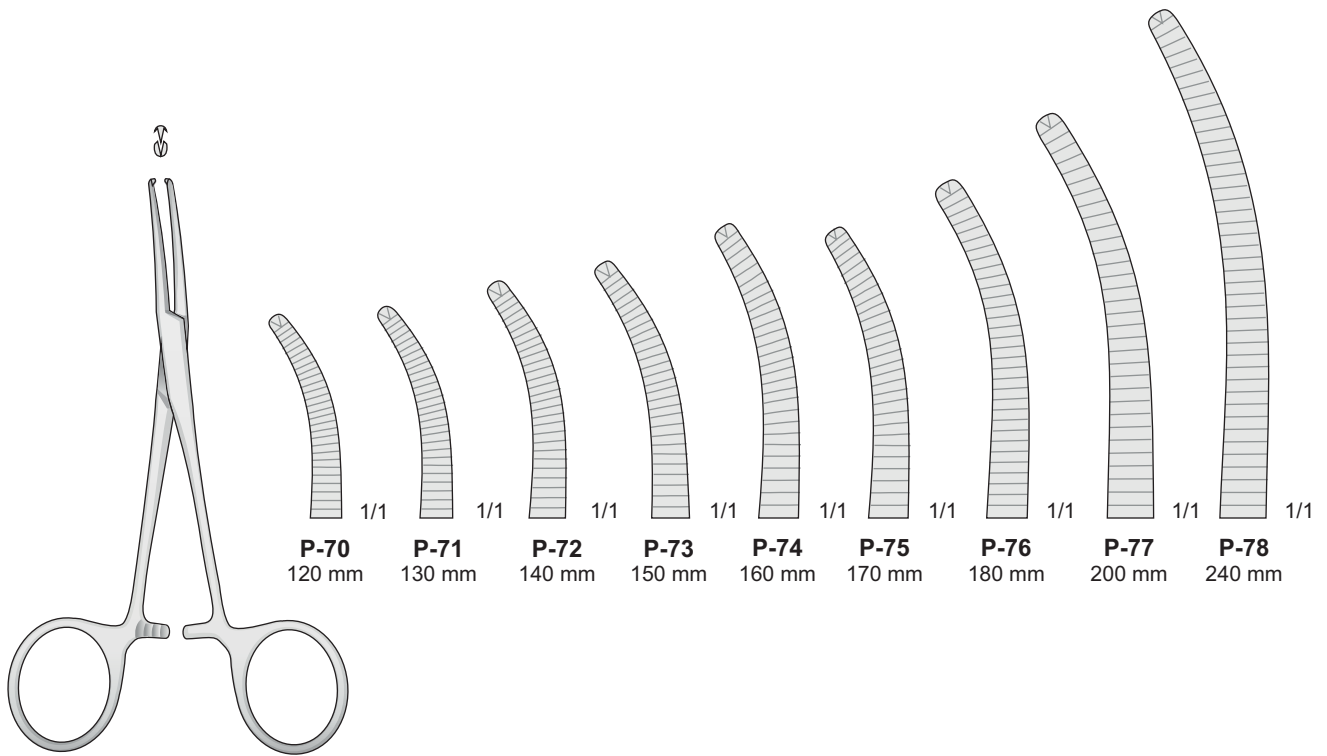


PEAN  
P-30/P-37

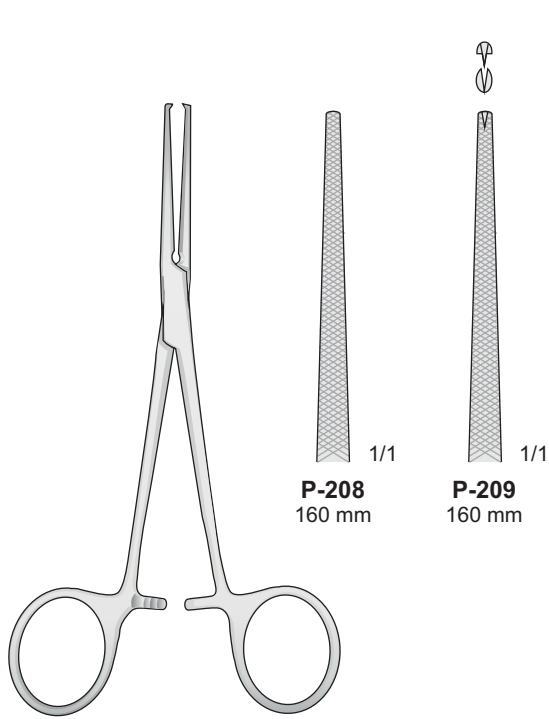




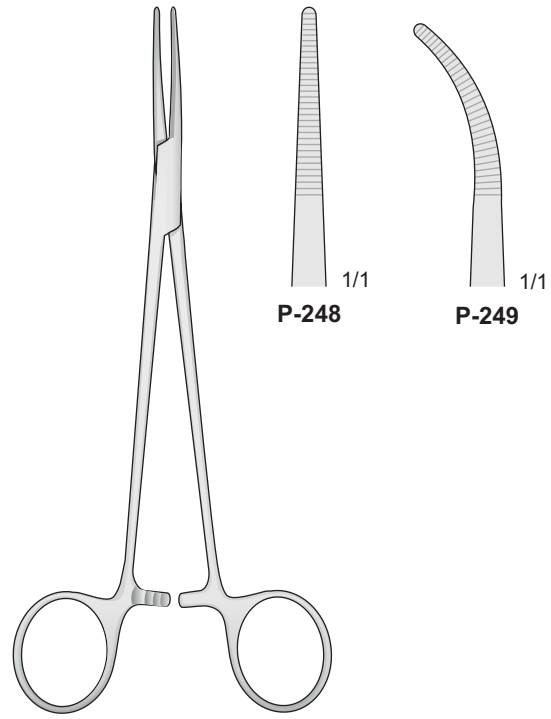
KOCHER  
P-40/P-47



KOCHER  
P-70/P-77

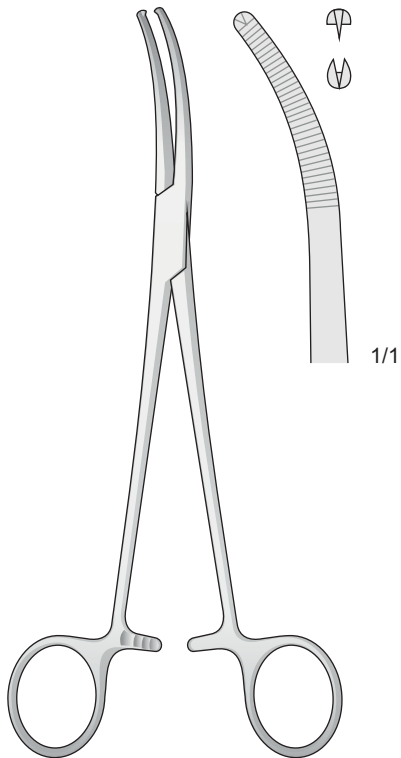


DIXON-LOVELACE  
P-208/P-209

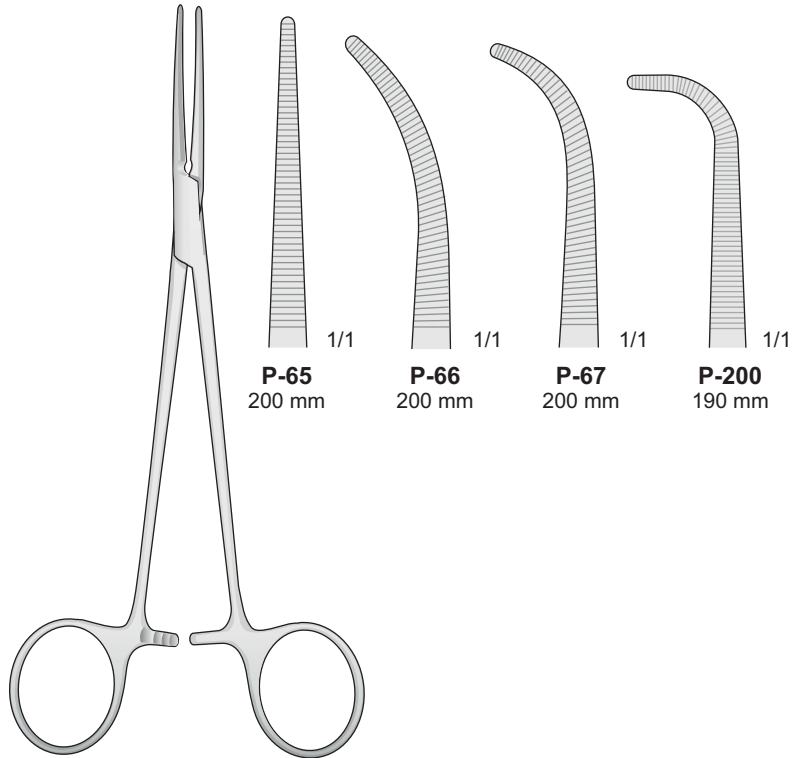


BIRKETT  
P-248/P-249  
180 mm

Pinza per peritoneo - Peritoneal clamps forceps  
Pritoneum klemmen - Pinces-camps pour les péritoine  
Pinzas-clamps para peritoneo

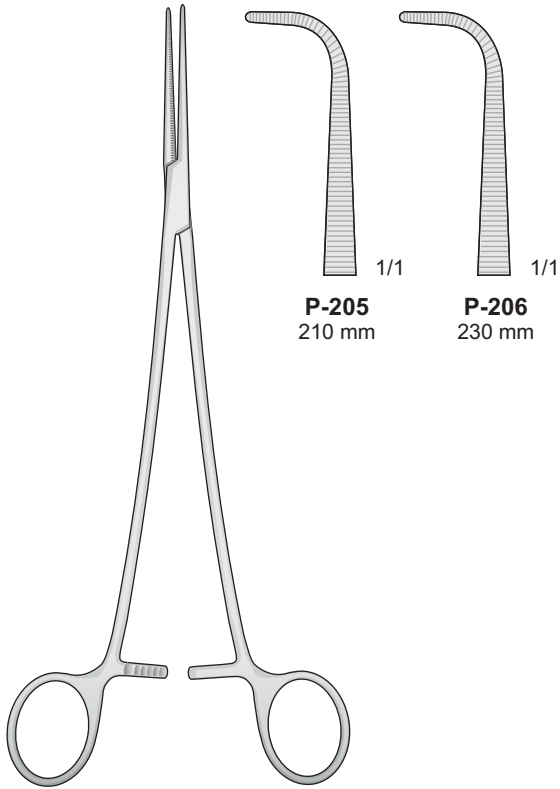


MIKULICZ  
P-104  
190 mm



HEISS  
P-65/P-200

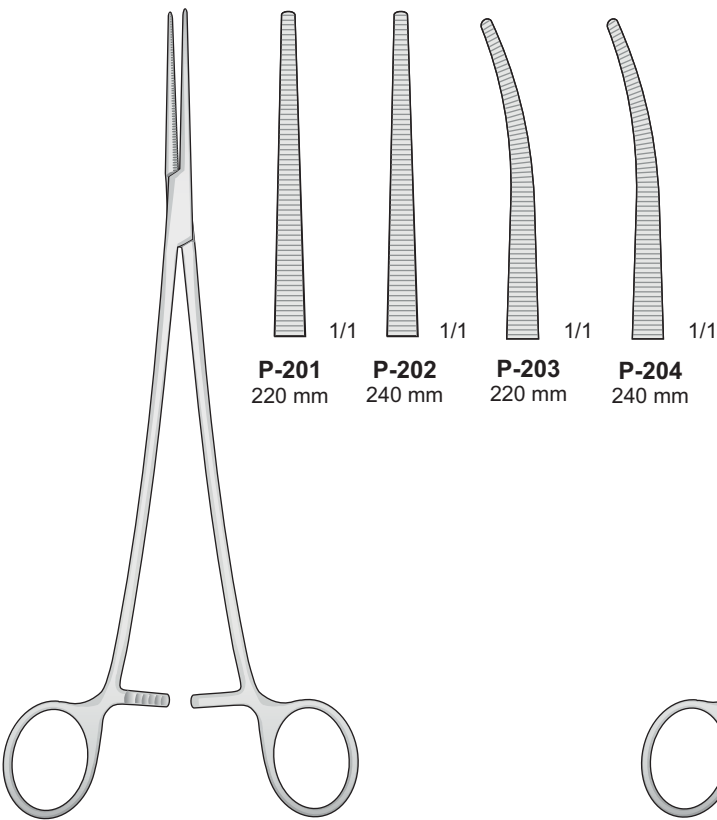




**P-205**  
210 mm

**P-206**  
230 mm

**BENGOLEA**  
**P-205/P-206**



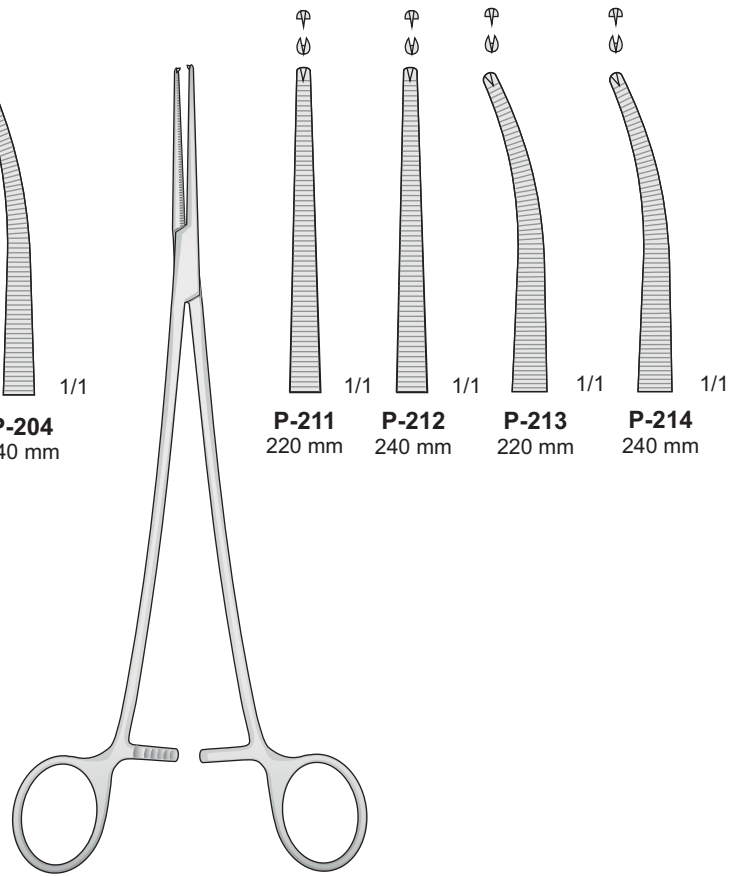
**P-201**  
220 mm

**P-202**  
240 mm

**P-203**  
220 mm

**P-204**  
240 mm

**BENGOLEA**  
**P-201/P-204**



**P-211**  
220 mm

**P-212**  
240 mm

**P-213**  
220 mm

**P-214**  
240 mm

**BENGOLEA**  
**P-211/P-214**



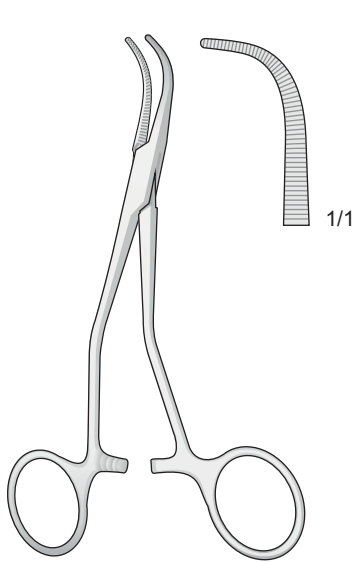
Pinze emostatiche  
per preparazioni  
e legature

Artery forceps  
for preparation  
and ligature

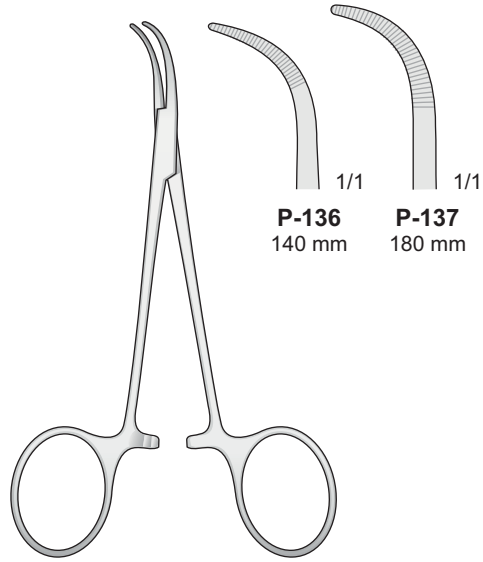
Arterienklemmen  
Präparier und  
Ligaturklemmen

Pinces hemostatiques  
à disséquer  
et à ligatures

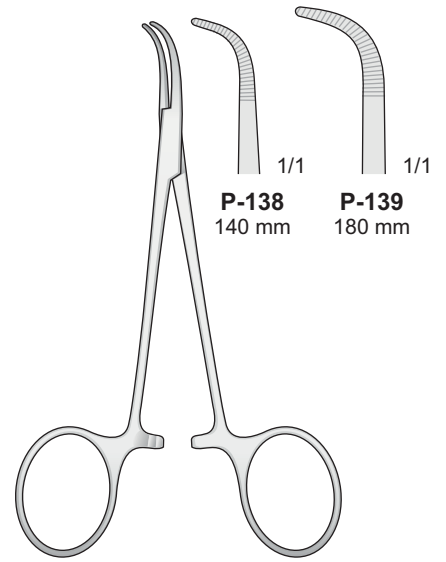
Pinzas hemostáticas  
Preparacion  
y para ligaduras



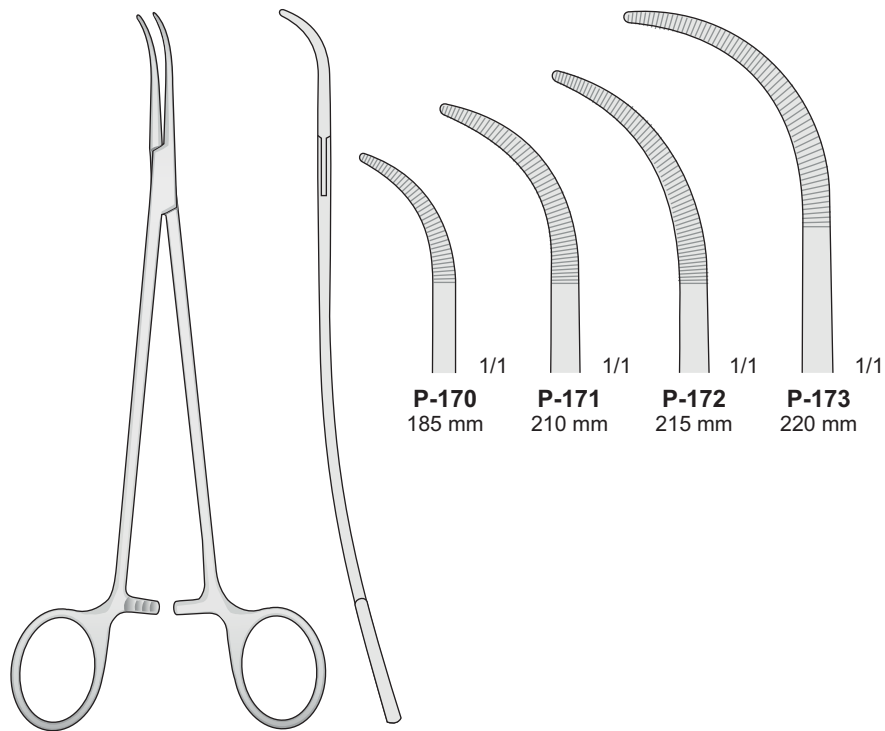
**P-15**  
130 mm



**BABY-MIXTER**  
**P-136/P-137**



**BABY-ADSON**  
**P-138/P-139**



**P-170/P-172**



Pinze emostatiche  
per preparazioni  
e legature

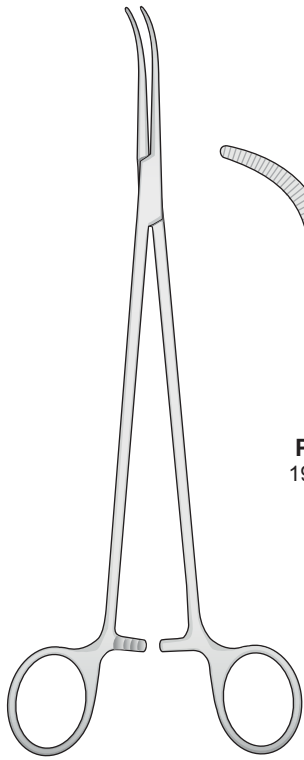
Artery forceps  
for preparation  
and ligature

Arterienklemmen  
Präparier und  
Ligaturklemmen

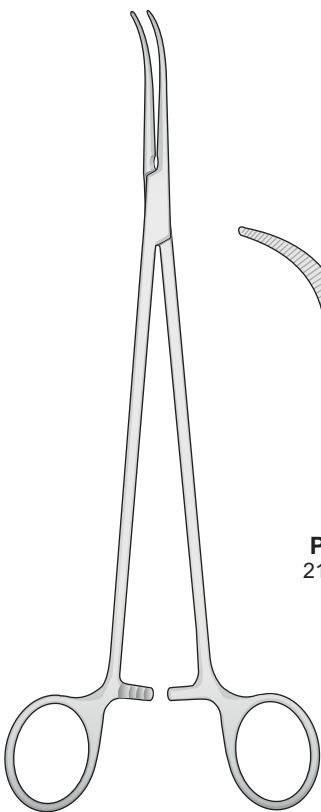
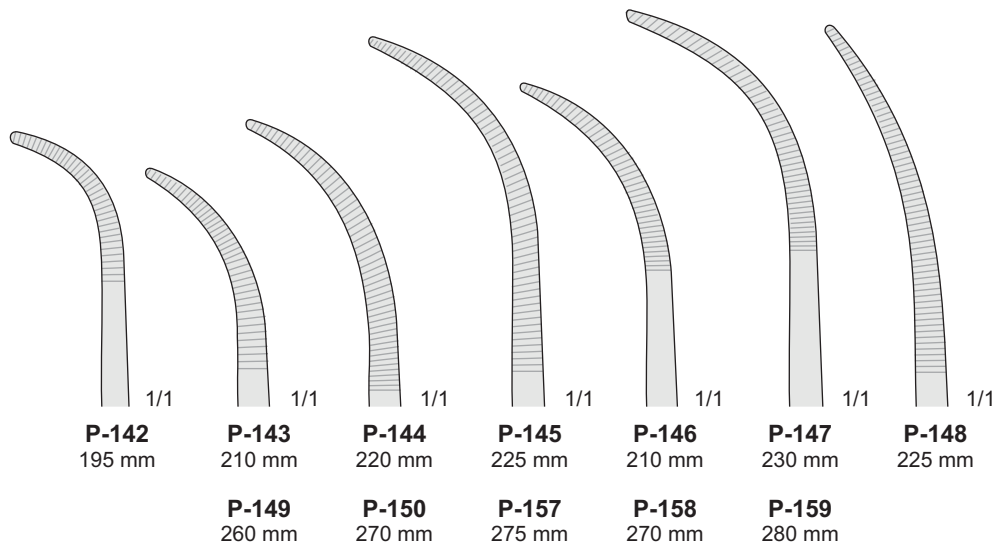
Pinces hemostatiques  
à disséquer  
et à ligatures

Pinzas hemostáticas  
Preparacion  
y para ligaduras

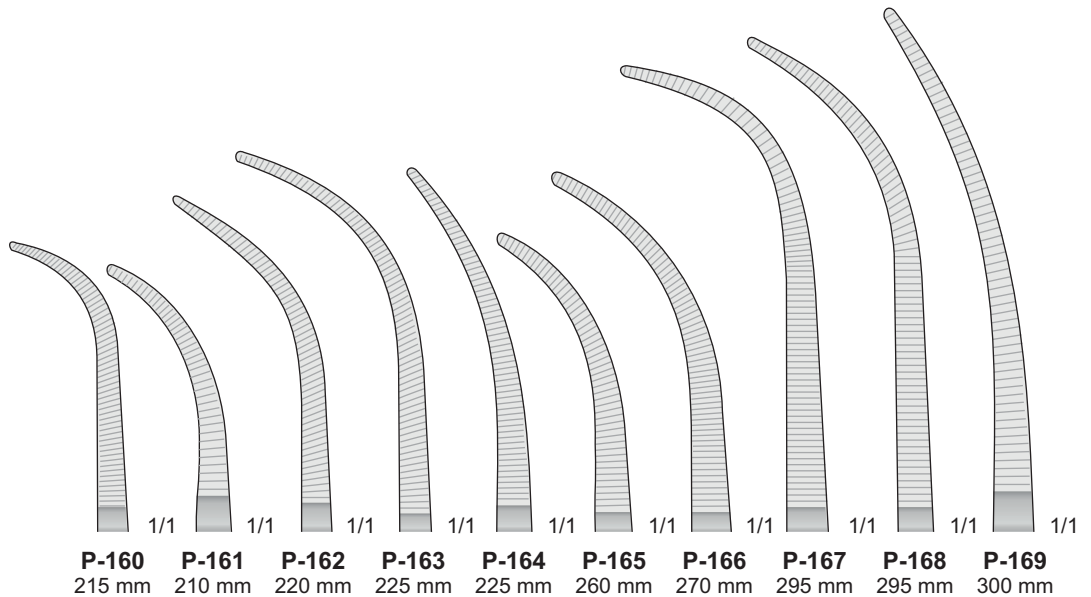
Passafili



OVERHOLT-GEISSENDORFER  
P-142/P-159



OVERHOLT  
P-160/P-169





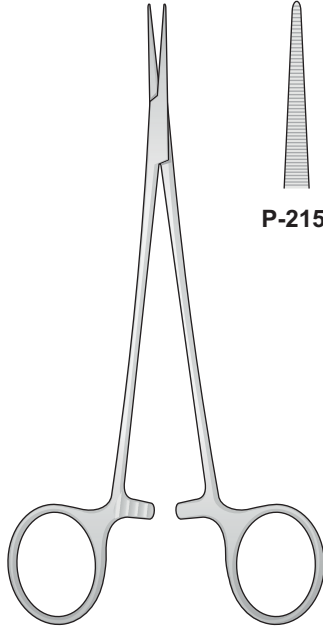
Pinze emostatiche  
per preparazioni  
e legature

Artery forceps  
for preparation  
and ligature

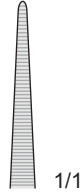
Arterienklemmen  
Präparier und  
Ligaturklemmen

Pinces hemostatiques  
à disséquer  
et à ligatures

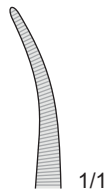
Pinzas hemostáticas  
Preparacion  
y para ligaduras



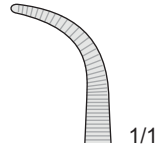
**P-215/P-217**  
160 mm



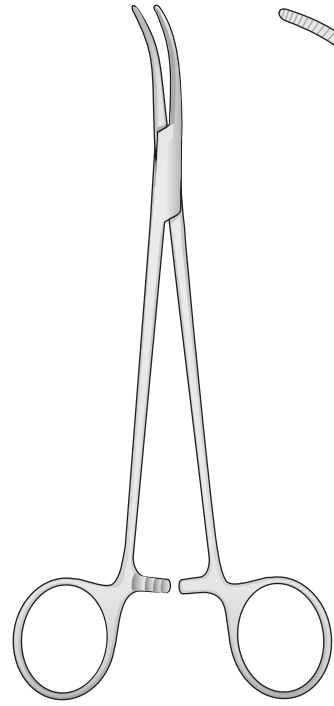
**P-215**



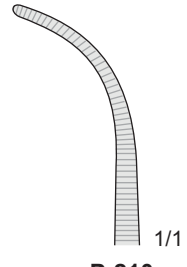
**P-216**



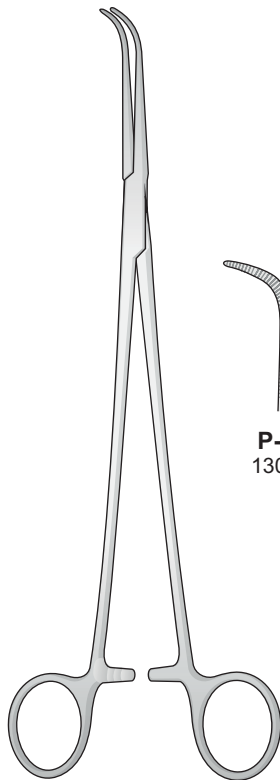
**P-217**



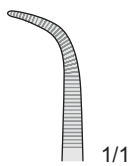
**ROCHESTER-PEAN**  
**P-210**  
180 mm



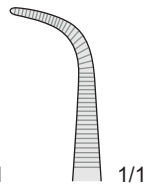
**P-210**



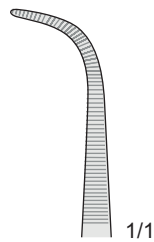
**GEMINI**  
**P-191/P-197**



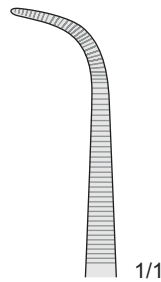
**P-191**  
130 mm



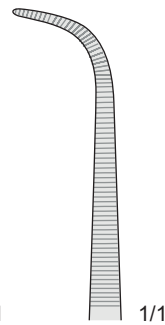
**P-192**  
160 mm



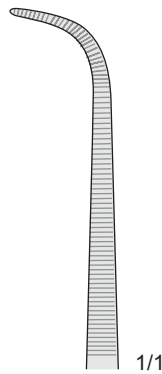
**P-193**  
180 mm



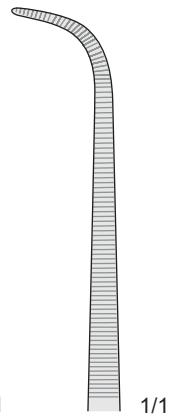
**P-194**  
200 mm



**P-195**  
230 mm



**P-196**  
250 mm



**P-197**  
280 mm



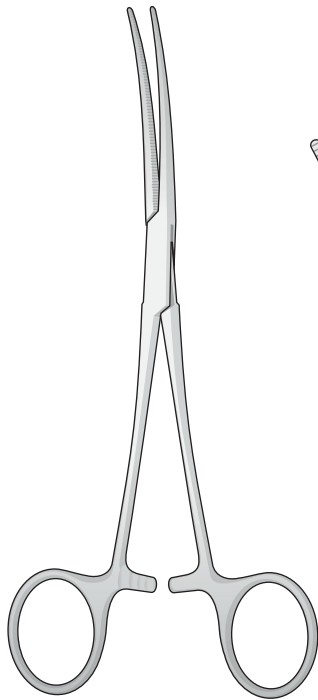
Pinze emostatiche  
per preparazioni  
e legature

Artery forceps  
for preparation  
and ligature

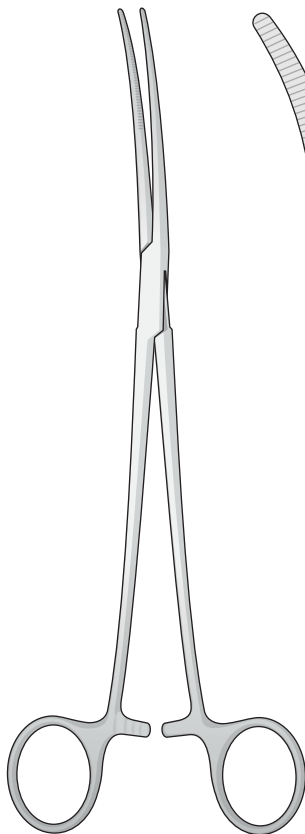
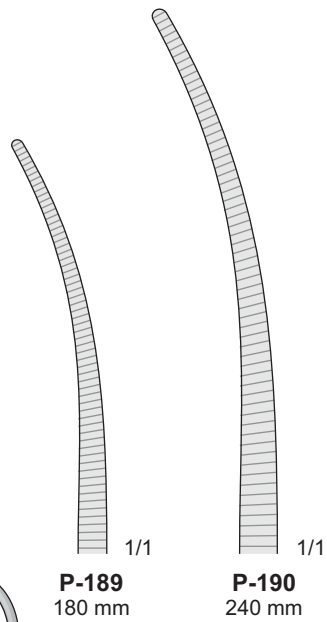
Arterienklemmen  
Präparier und  
Ligaturklemmen

Pinces hemostatiques  
à disséquer  
et à ligatures

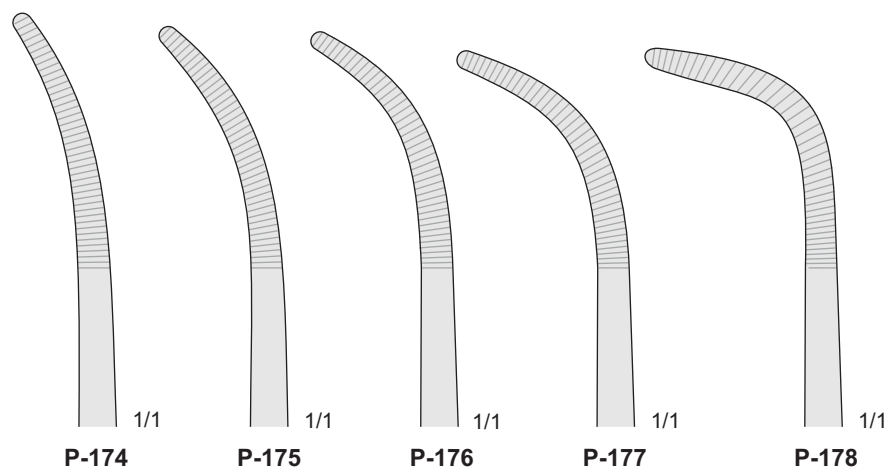
Pinzas hemostáticas  
Preparacion  
y para ligaduras



CRAFOORD  
P-189/P-190



RUMEL  
P-174/P-178  
240 mm





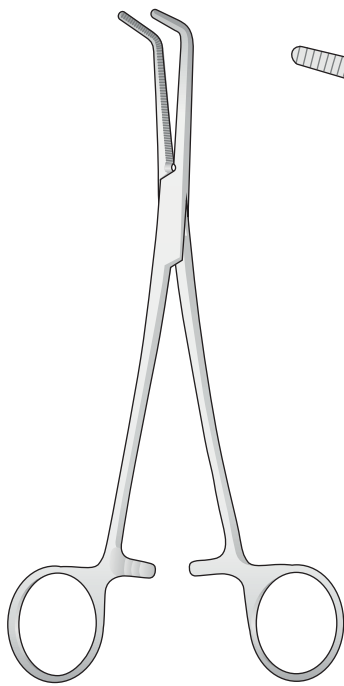
Pinze emostatiche  
per preparazioni  
e legature

Artery forceps  
for preparation  
and ligature

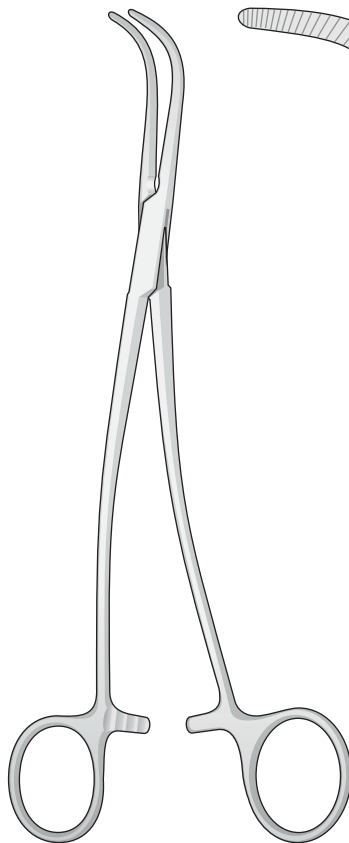
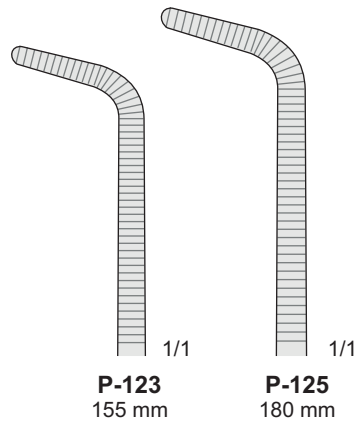
Arterienklemmen  
Präparier und  
Ligaturklemmen

Pinces hémostatiques  
à disséquer  
et à ligatures

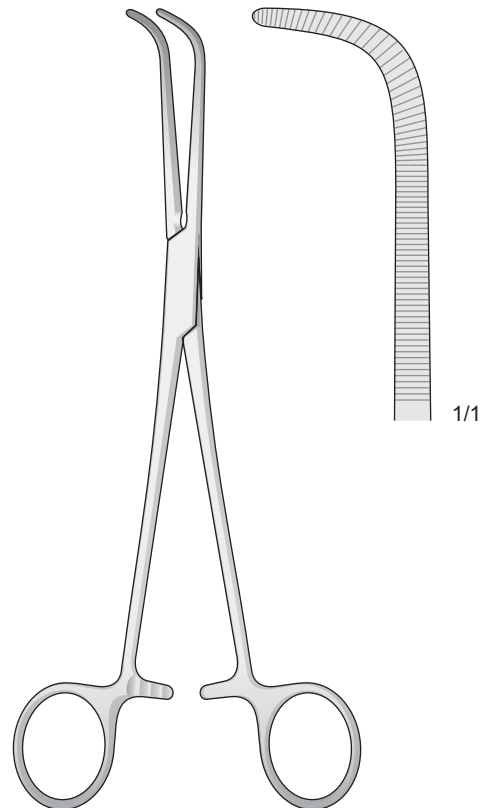
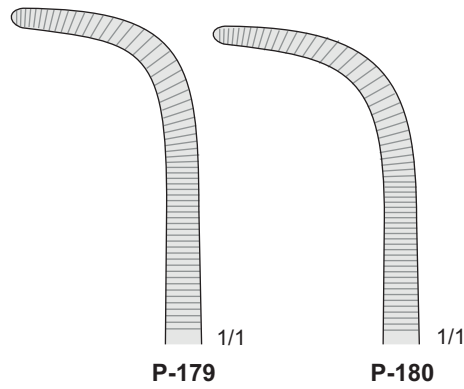
Pinzas hemostáticas  
Preparacion  
y para ligaduras



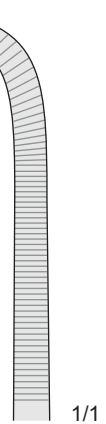
MIXTER  
P-123/P-125



GRAY  
P-179/P-180  
220 mm



WIKSTROEM  
P-181  
205 mm





Pinze emostatiche  
per preparazioni  
e legature

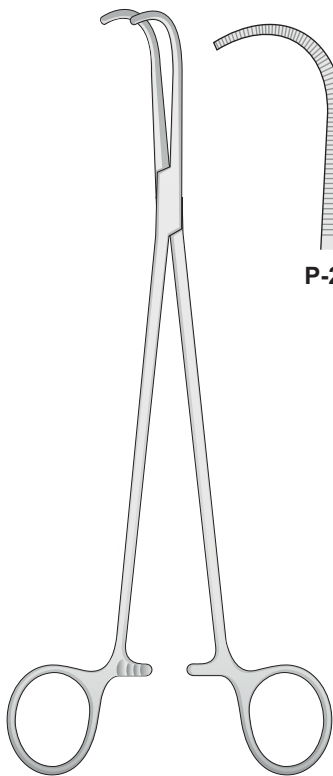
Artery forceps  
for preparation  
and ligature

Arterienklemmen  
Präparier und  
Ligaturklemmen

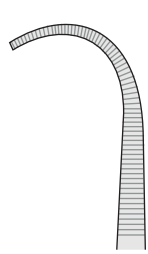
Pinces hemostatiques  
à disséquer  
et à ligatures

Pinzas hemostáticas  
Preparacion  
y para ligaduras

Pinze per tonsille  
Tonsil forceps  
Tonsillenklemmen  
Pincés pour amygdales  
Pinzas para amigdalas

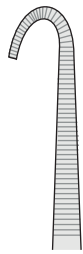


NEGUS  
P-222/P-223  
190 mm



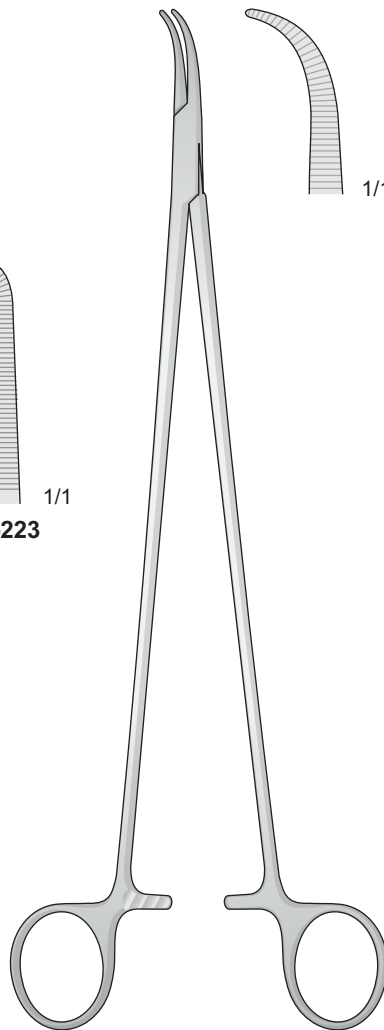
P-222

1/1

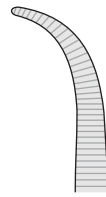


P-223

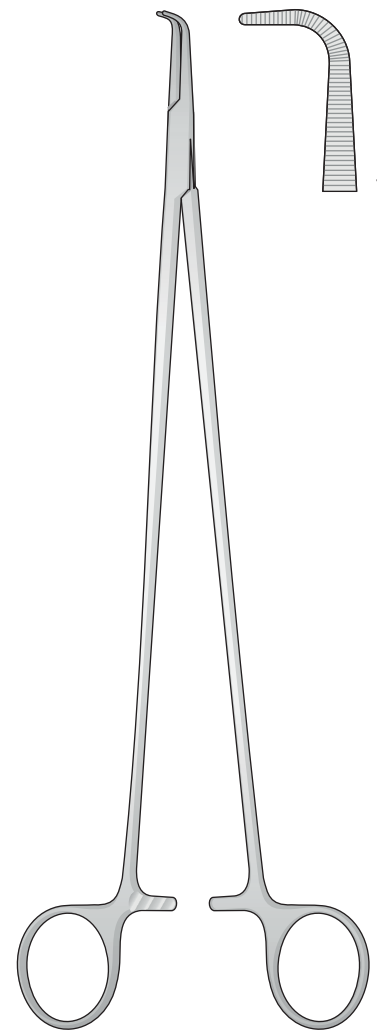
1/1



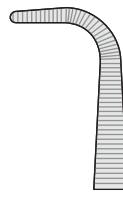
LAWRENCE  
P-198  
270 mm



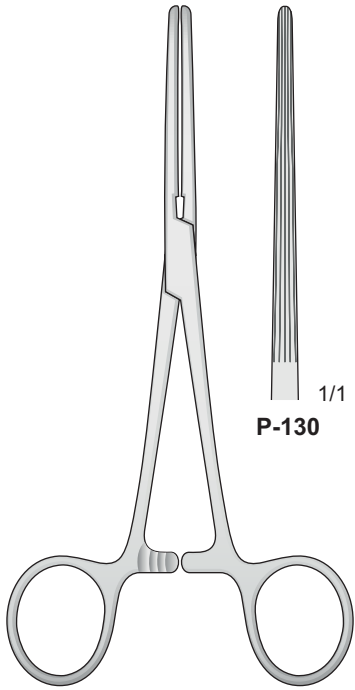
1/1



MEEKER  
P-199  
275 mm



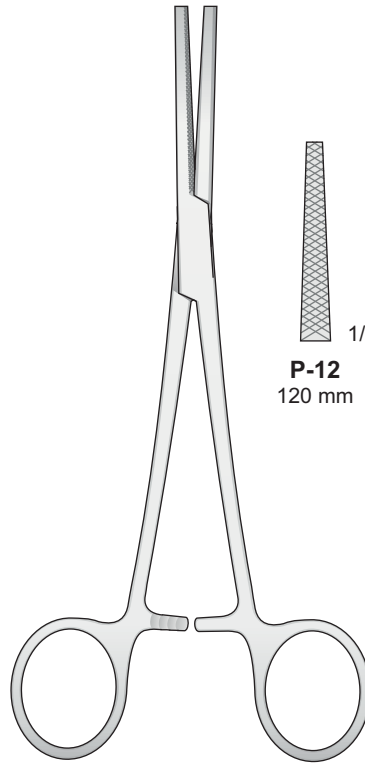
1/1



BAINBRIDGE  
P-130/P-131  
150 mm

P-130  
1/1

P-131  
1/1



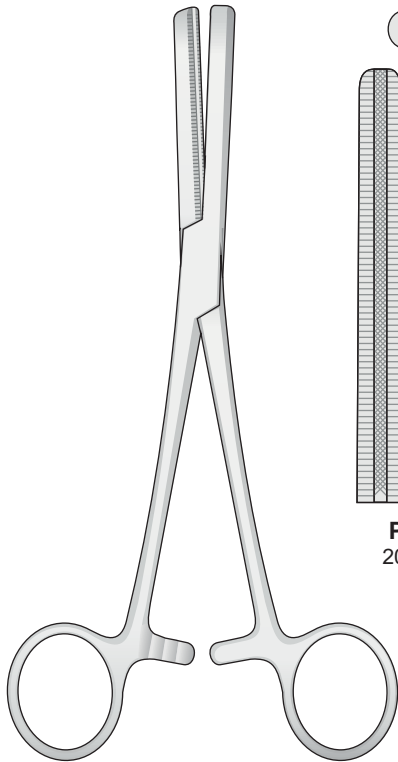
P-12/P-14

P-12  
120 mm  
1/1

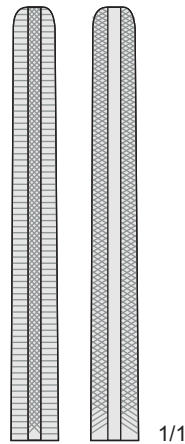
P-13  
180 mm  
1/1

P-14  
200 mm  
1/1

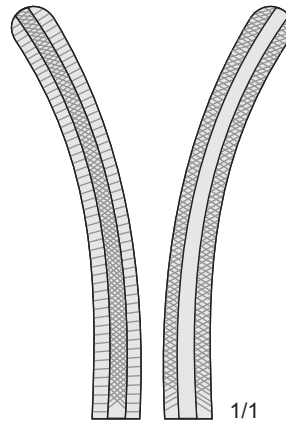
Angiotribe - Druckklemmen  
Angiotribes - Pinzas-clamps para presión progresiva



FERGUSSON  
P-140/P-141

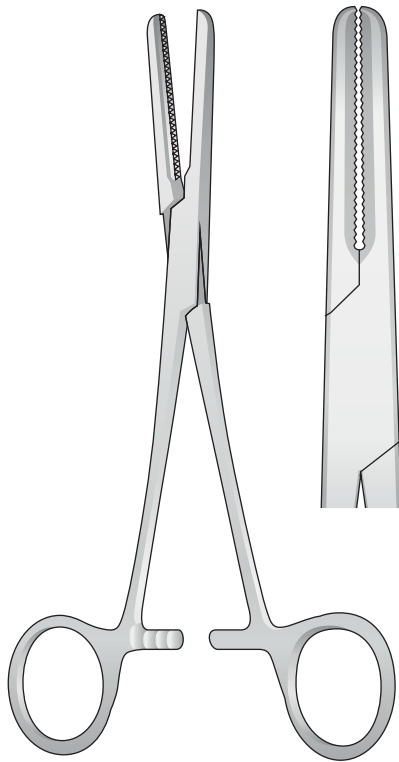


P-140  
200 mm  
1/1

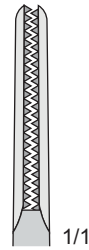


P-141  
200 mm  
1/1

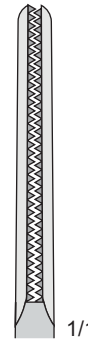




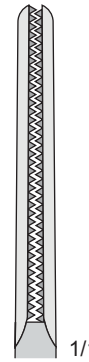
**P-151/P-153**



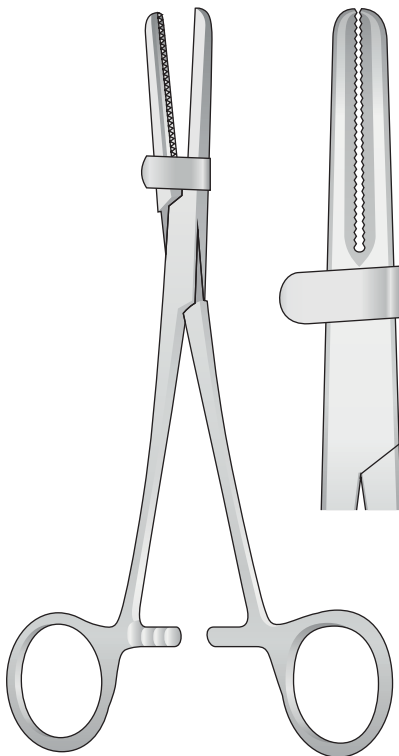
**P-151**  
150 mm



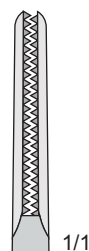
**P-152**  
180 mm



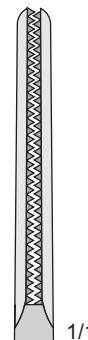
**P-153**  
200 mm



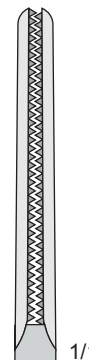
**P-154/P-156**



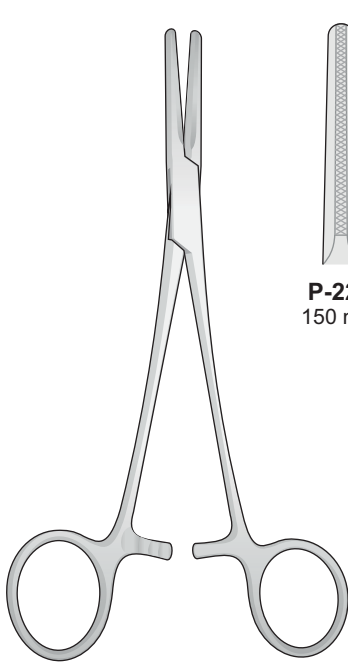
**P-154**  
150 mm



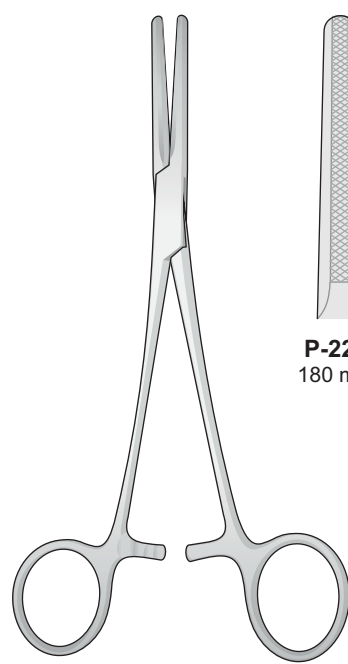
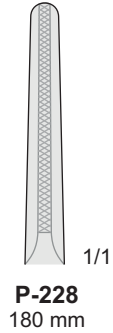
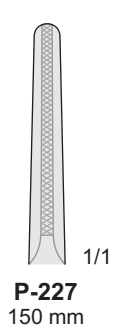
**P-155**  
180 mm



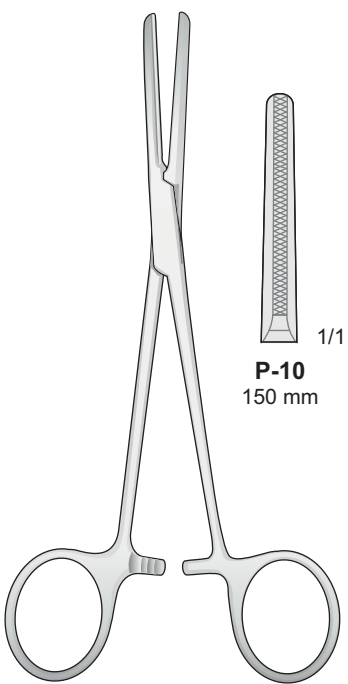
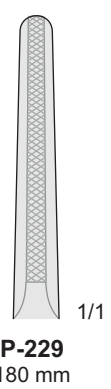
**P-156**  
200 mm



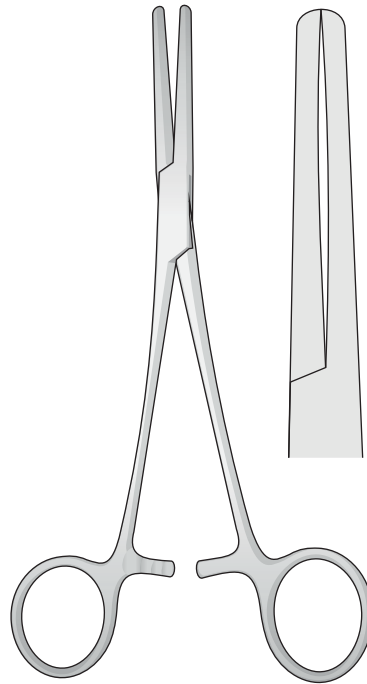
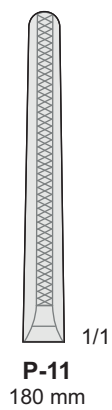
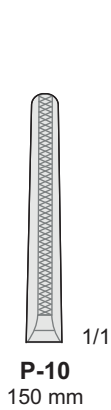
**P-227/P-228**



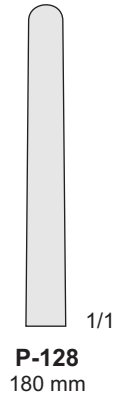
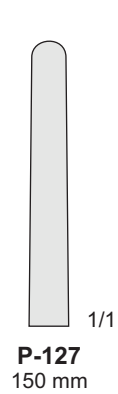
**P-229**  
180 mm



**P-10/P-11**



**P-127/P-128**





6

Enterostati, Pinze atraumatiche  
Atraumatic vessel clamps  
Atraumatische Gefäßklemmen  
Pincés atraumatiques  
Pinzas vasculares atraumáticas





Pinze intestinali  
elastiche

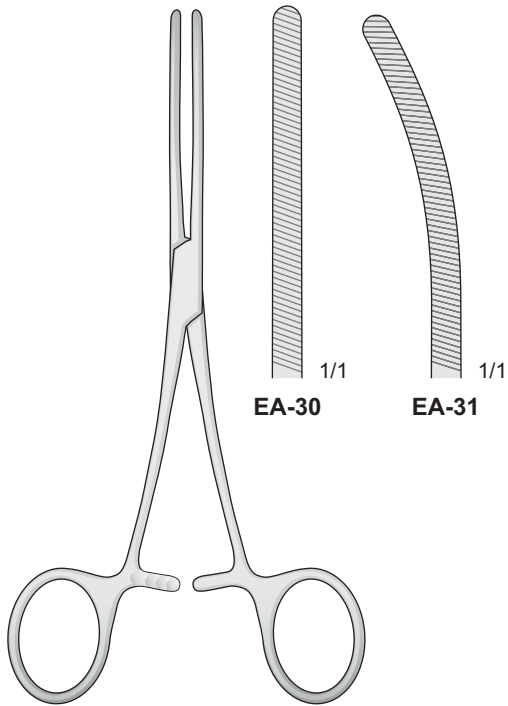
Intestinal clamps  
soft elastic

Darmklemmen  
Elastisch

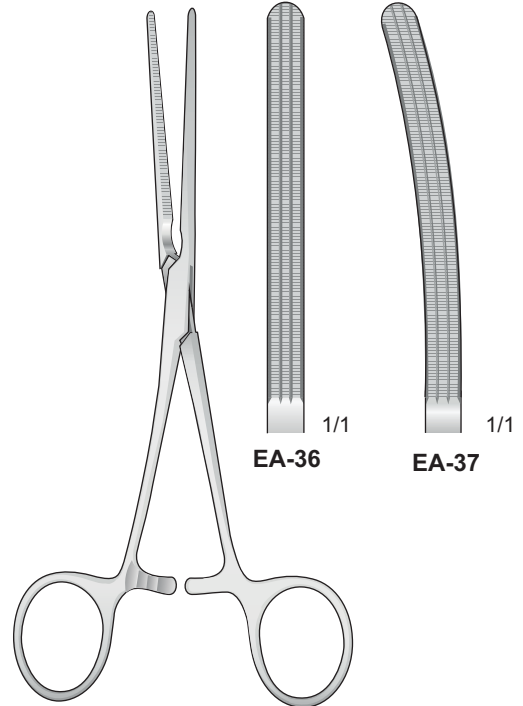
Pinces  
intestinales

Pinzas  
intestinales

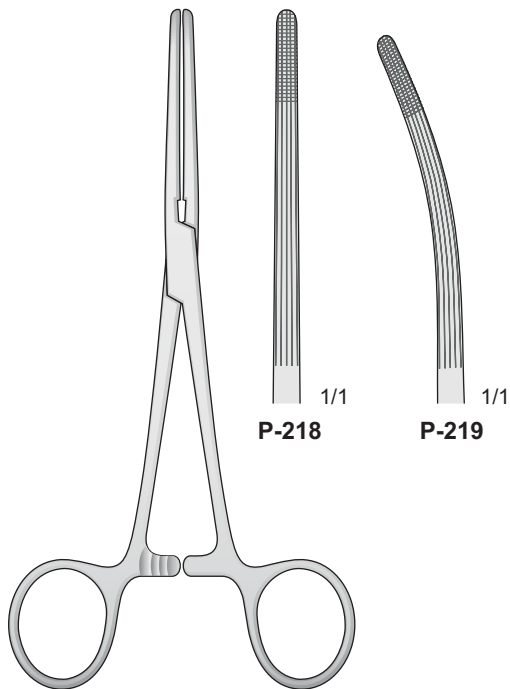
Atraumatiche - Atraumatic  
Atraumatische - Atraumatiques - Atraumáticas



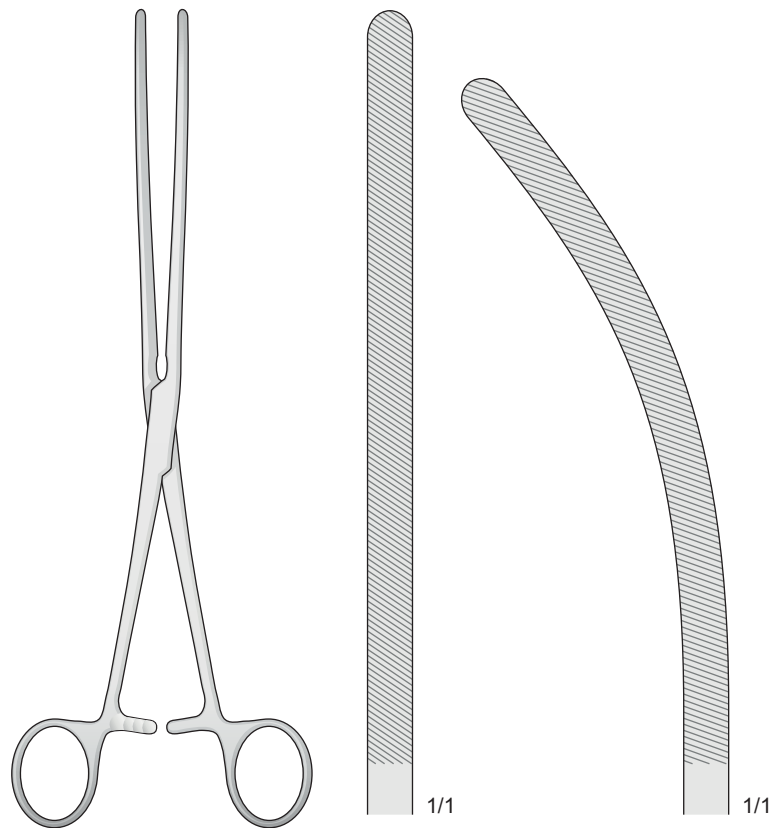
DOYEN  
EA-30/EA-31  
170 mm



DOYEN  
EA-36/EA-37  
170 mm



ROCHESTER-CARMALT  
P-218/P-219  
160 mm



DOYEN  
EA-32/EA-33  
230 mm



Pinze intestinali  
elastiche

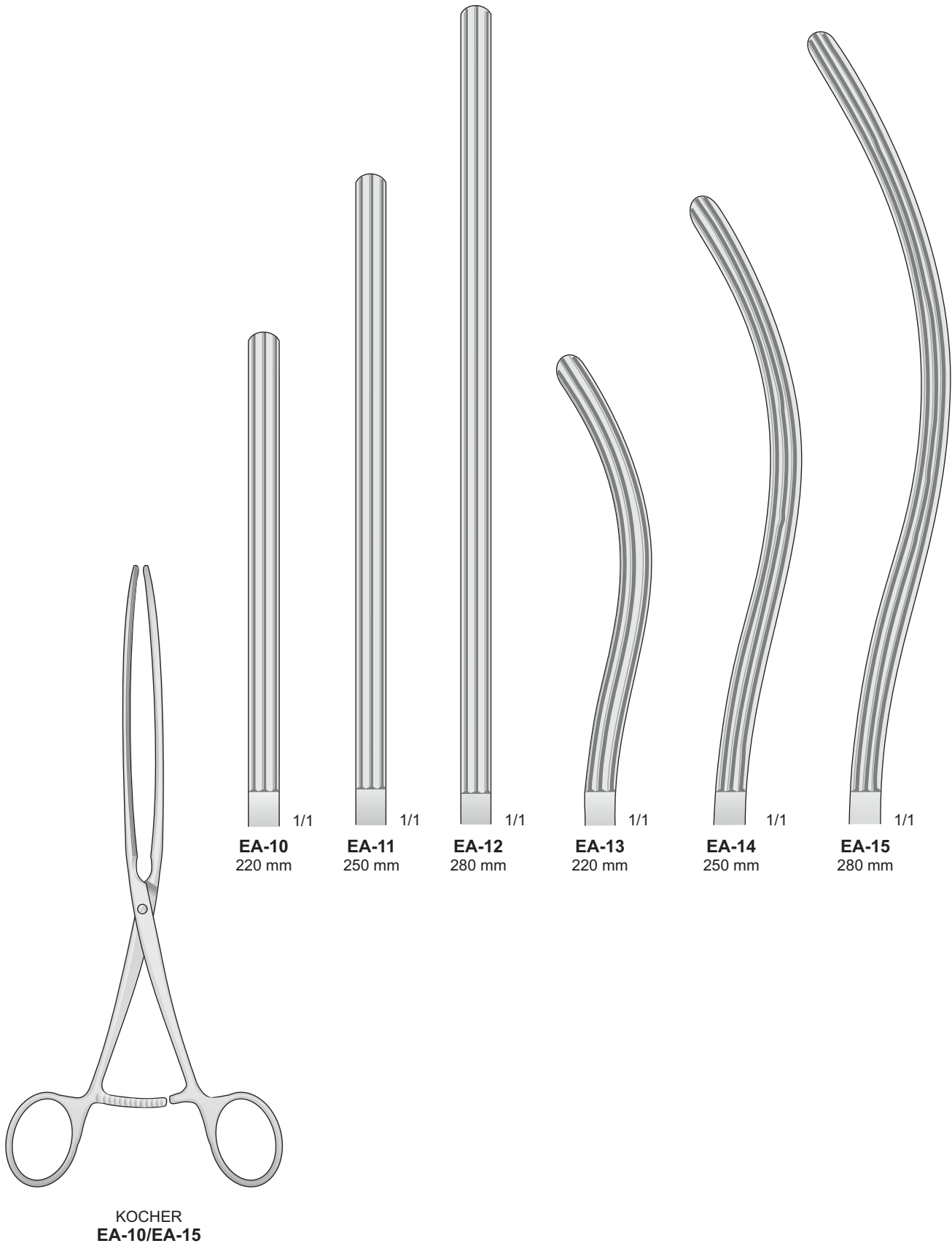
Intestinal clamps  
soft elastic

Darmklemmen  
Elastisch

Pinces  
intestinales

Pinzas  
intestinales

Elastiche - Elastisch - Elastich - Elastic - Elasticas





Pinze intestinali  
elastiche

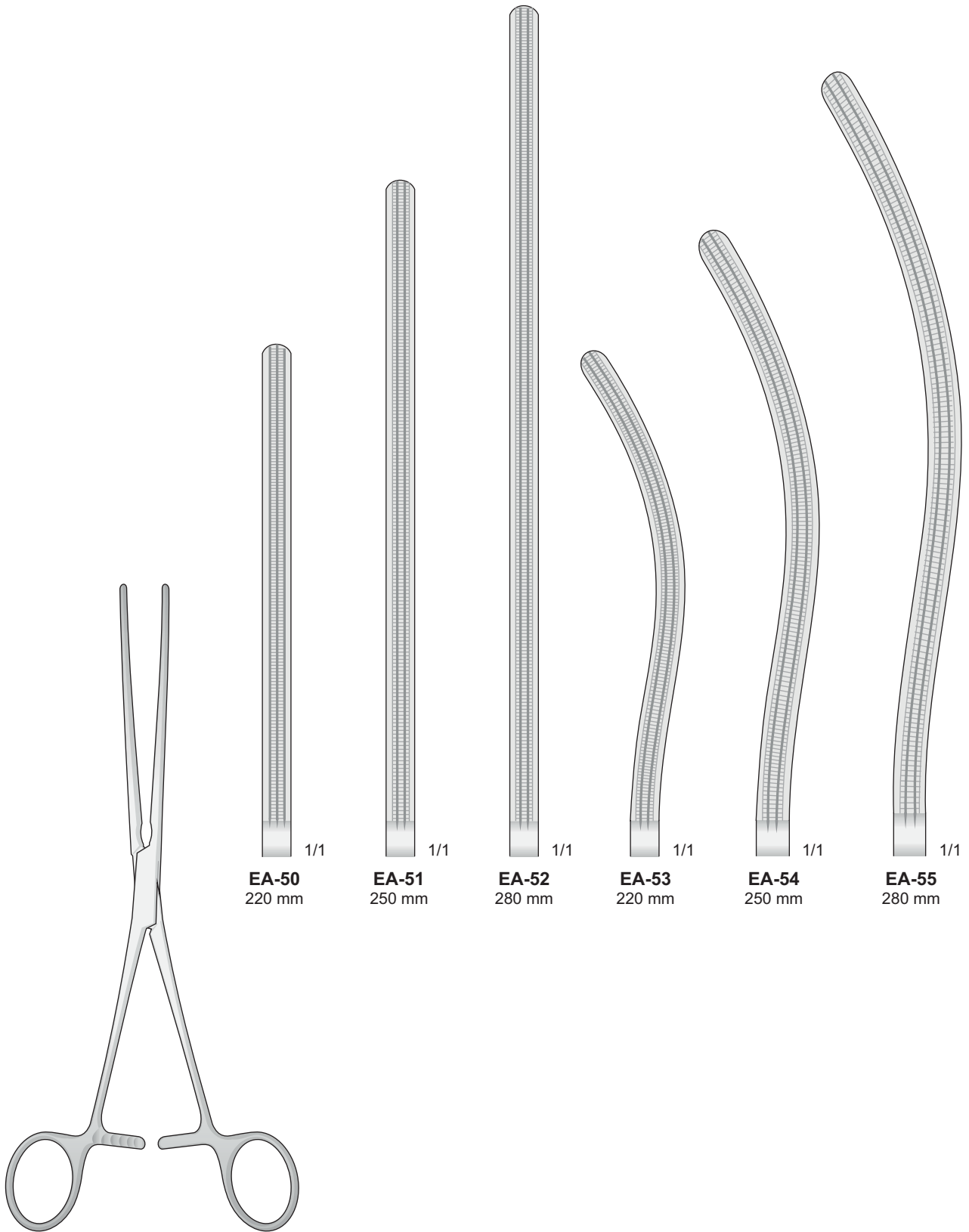
Intestinal clamps  
soft elastic

Darmklemmen  
Elastisch

Pinces  
intestinales

Pinzas  
intestinales

Atraumatiche - Atraumatic  
Atraumatische - Atraumatiques - Atraumáticas



EA-50  
220 mm

EA-51  
250 mm

EA-52  
280 mm

EA-53  
220 mm

EA-54  
250 mm

EA-55  
280 mm

KOCHER  
EA-50/EA55



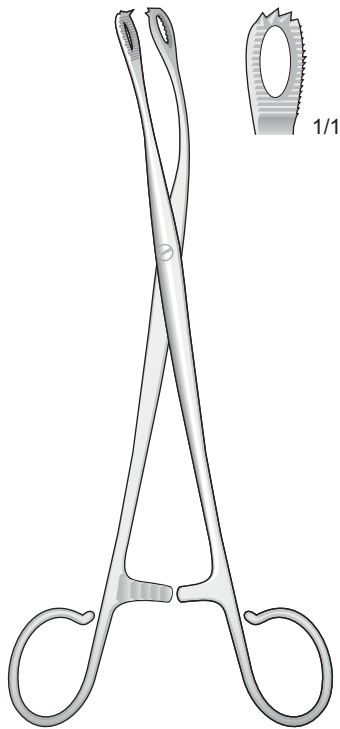
Pinze per intestino  
e stomaco

Intestinal-stomach  
clamps

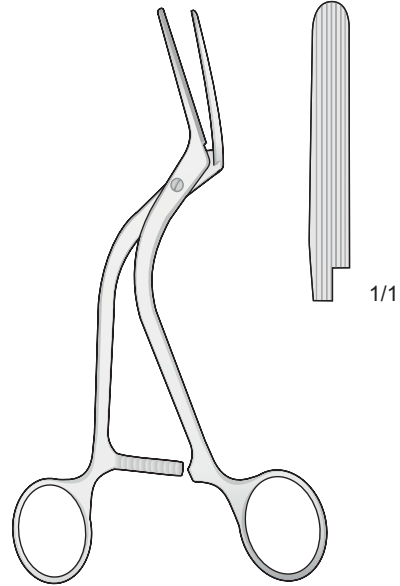
Darm-magen  
Gefäßklemmen

Pinces-clamps  
pour l'intestin et l'estomac

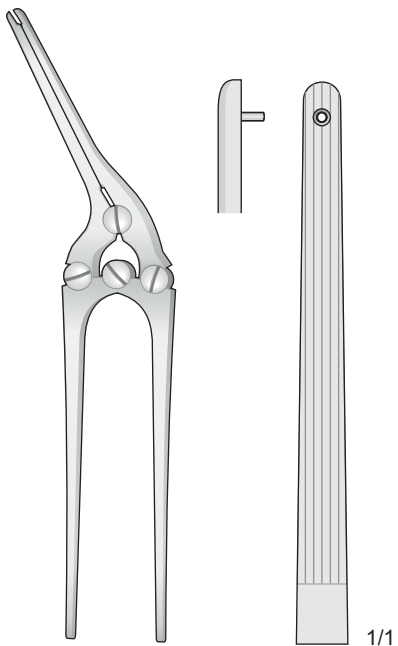
Pinzas intestinales  
stomacales



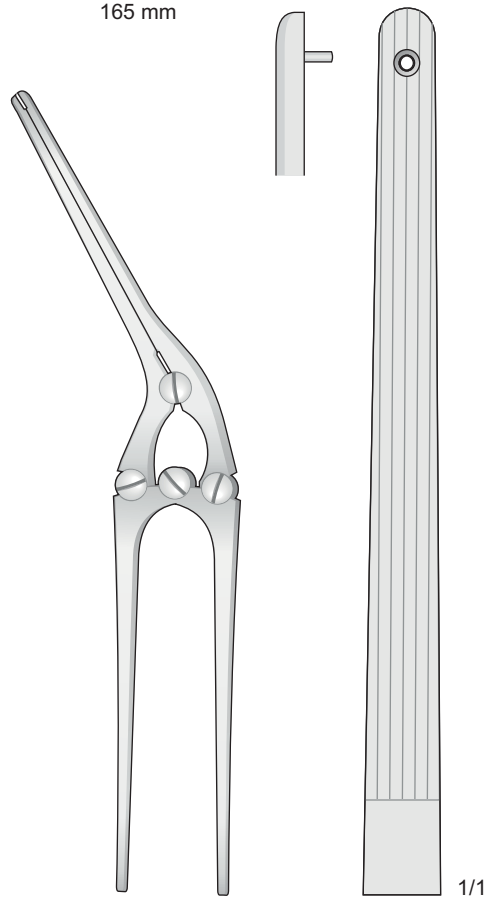
**BLOHMKE  
P-220**  
200 mm



**HÖPFNER  
P-07**  
165 mm



**PAYR  
EA-20**  
200 mm



**PAYR  
EA-21**  
280 mm





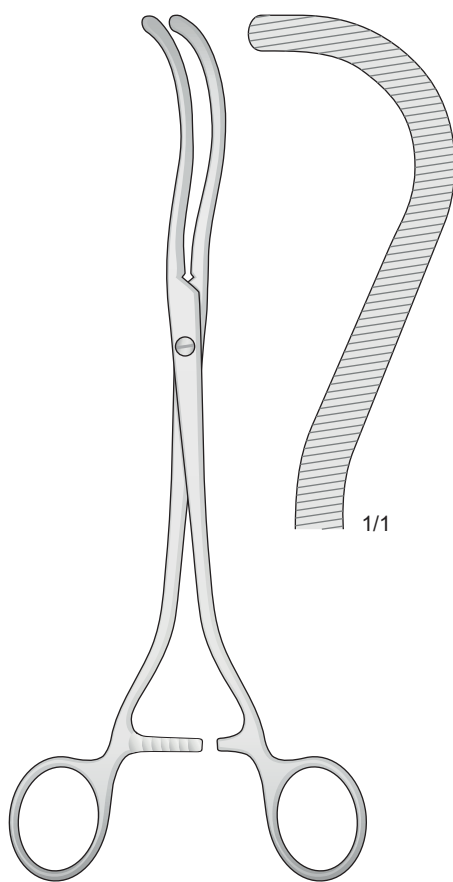
Pinze per  
peduncoli renali

Kidney pedicle  
clamps forceps

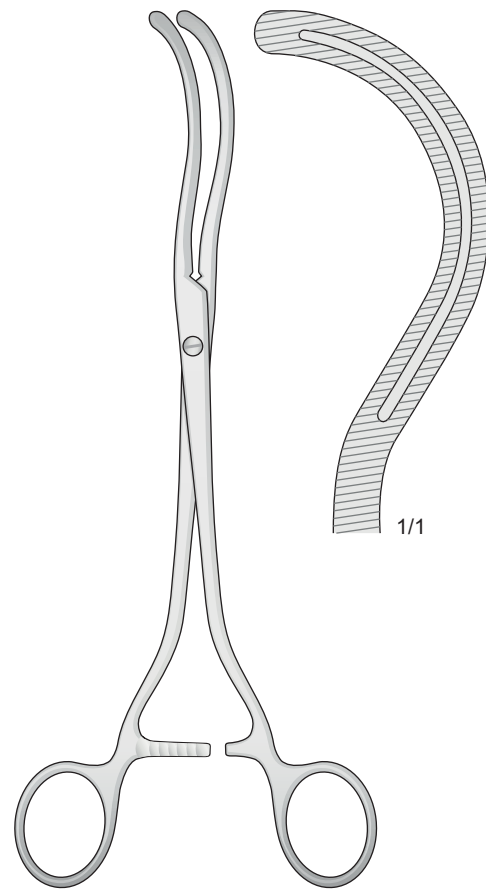
Nierenstielklemmen

Pinces-clamps pour  
pédicules rénaux

Pinzas clamps para  
pedúnculos renales



GUYON  
EB-31  
235 mm



STILLE  
EB-32  
240 mm



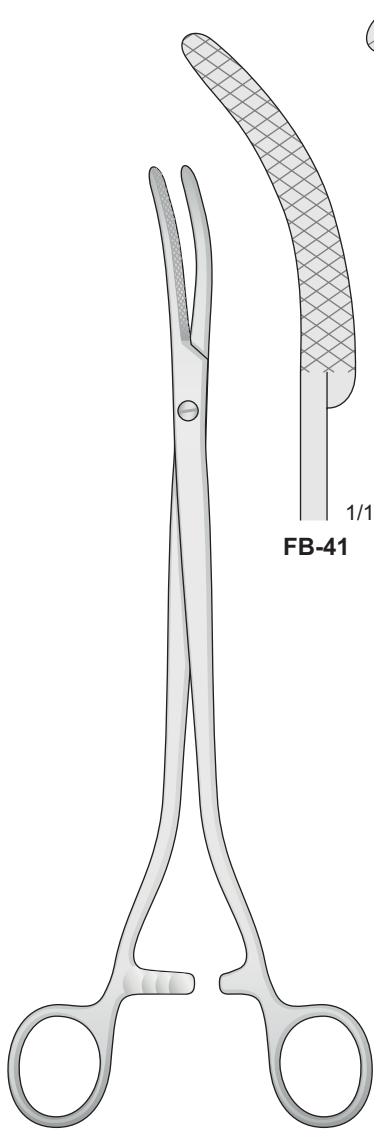
Pinze per  
peduncoli renali

Kidney pedicle  
clamps forceps

Nierenstielklemmen

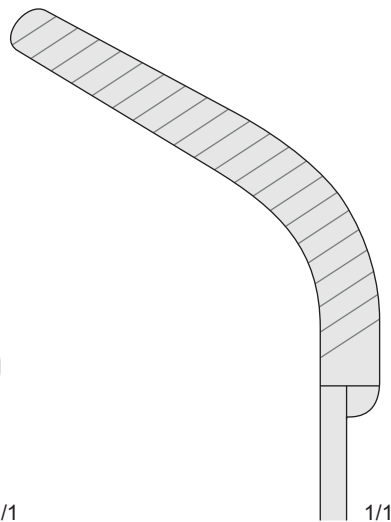
Pinces-clamps pour  
pédicules rénaux

Pinzas clamps para  
pedúnculos renales

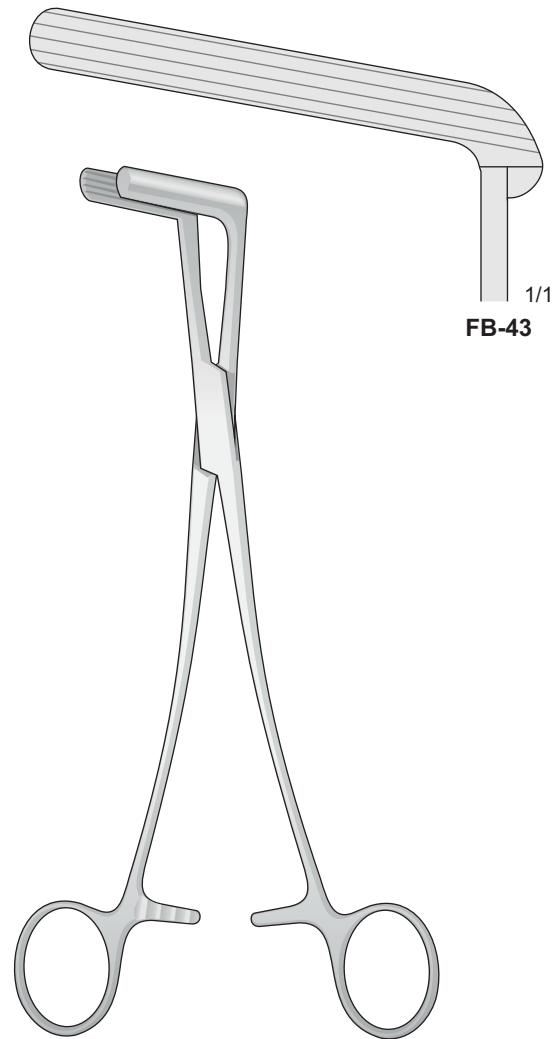


1/1  
FB-41

WERTHEIM  
FB-41  
260 mm

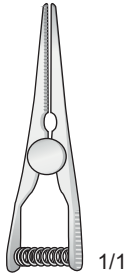


1/1  
FB-42

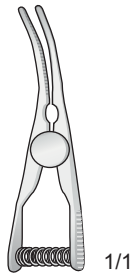


1/1  
FB-43

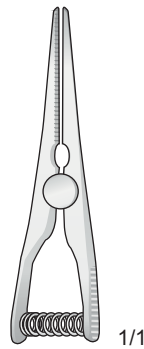
WERTHEIM  
FB-42/FB-43  
235 mm



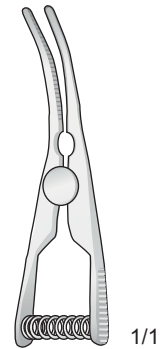
**FB-84**  
35 mm



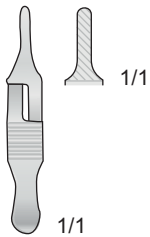
**FB-85**  
35 mm



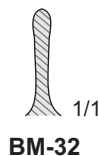
**FB-86**  
45 mm



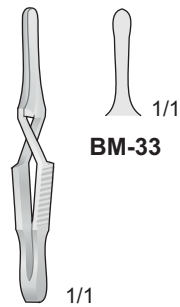
**FB-87**  
45 mm



**BM-27**  
30 mm



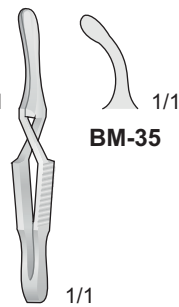
**BM-32**



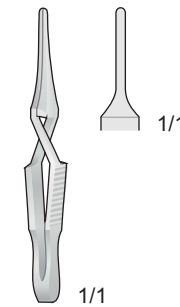
**BM-33**



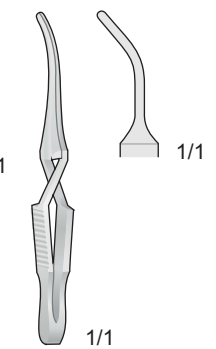
**BM-34**



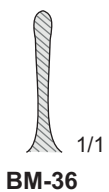
**BM-35**



**BM-93**  
40 mm



**BM-95**  
45 mm

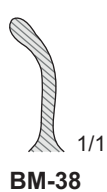


**BM-36**



**BM-37**

**DIFFENBACH**  
**BM-36/BM-37**  
45 mm

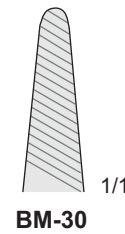


**BM-38**



**BM-39**

**DIFFENBACH**  
**BM-38/BM-39**  
45 mm



**BM-30**



**BM-31**

**DIFFENBACH**  
**BM-30/BM-31**  
60 mm



**Pinze**  
**Atrauma Bulldog**

**Atrauma**  
**Bulldog clamps**

**Atrauma**  
**Bulldogklemmen**

**Clamps**  
**Bulldog Atrauma**

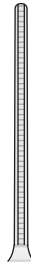
**Pinzas**  
**Atrauma Bulldog**



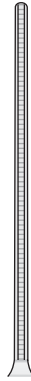
**FB-67/FB-70**



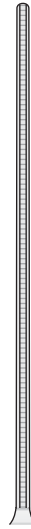
**FB-67**  
75 mm



**FB-68**  
85 mm

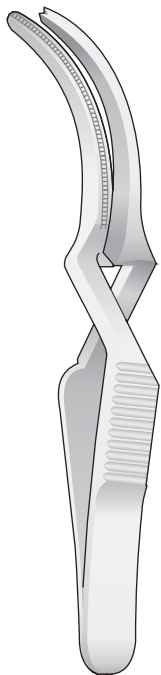


**FB-69**  
105 mm



**FB-70**  
120 mm

Pinza per applicare e rimuovere Bulldog clamps  
Zange zum Anziehen der Bulldogklemmen  
Forceps for applying and removing Bulldog clamps  
Pincés pour applicateur clamps Bulldog  
Pinzas de aplicación para pinzas Bulldog



**FB-71/FB-74**



**FB-71**  
70 mm



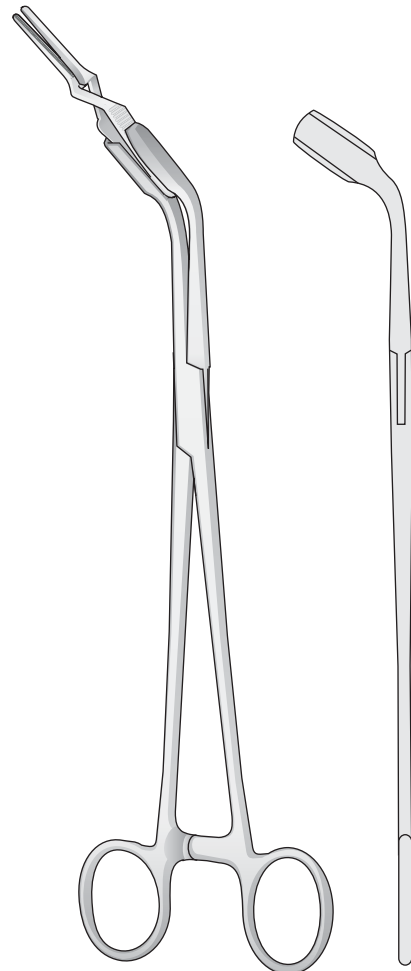
**FB-72**  
80 mm



**FB-73**  
100 mm



**FB-74**  
115 mm



**FB-75**  
230 mm



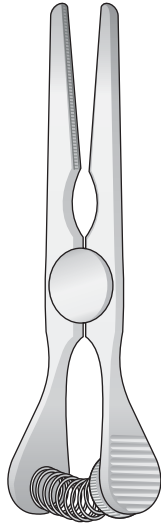
Pinze  
Atrauma Bulldog

Atrauma  
Bulldog clamps

Atrauma  
Bulldogklemmen

Clamps  
Bulldog Atrauma

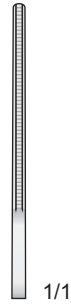
Pinzas  
Atrauma Bulldog



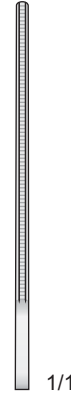
GLOVER  
FB-76/FB-79



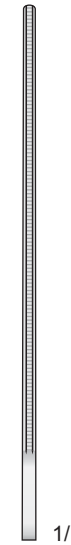
**FB-76**  
60 mm



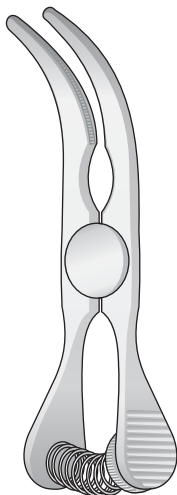
**FB-77**  
70 mm



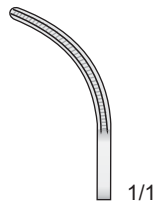
**FB-78**  
90 mm



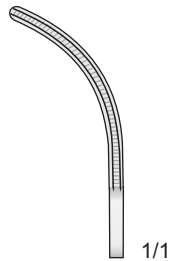
**FB-79**  
110 mm



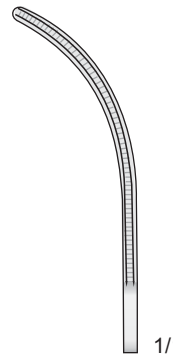
GLOVER  
FB-80/FB-83



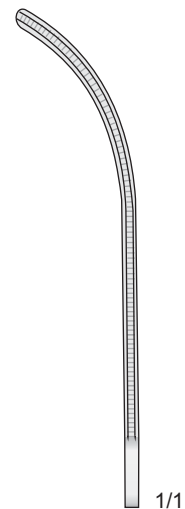
**FB-80**  
55 mm



**FB-81**  
65 mm



**FB-82**  
85 mm



**FB-83**  
105 mm



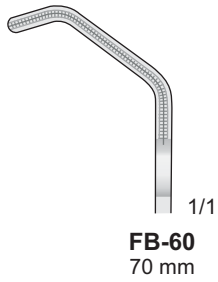
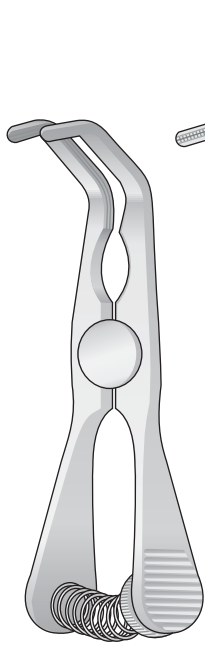
Pinze  
Atrauma Bulldog

Atrauma  
Bulldog clamps

Atrauma  
Bulldogklemmen

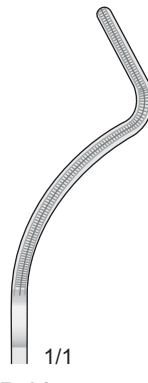
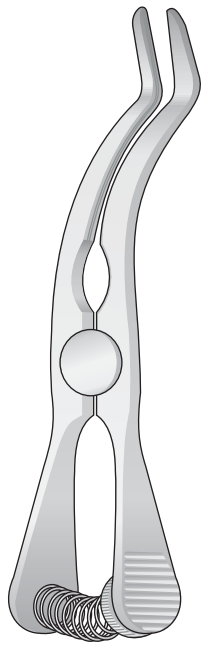
Clamps  
Bulldog Atrauma

Pinzas  
Atrauma Bulldog



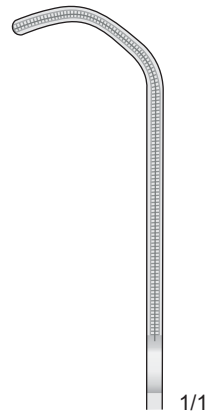
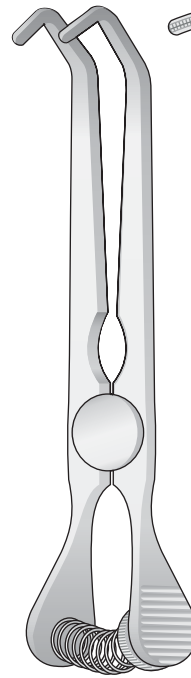
**FB-60**  
70 mm

DE BAKEY-SATINSKY  
**FB-60**  
70 mm



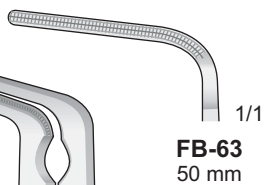
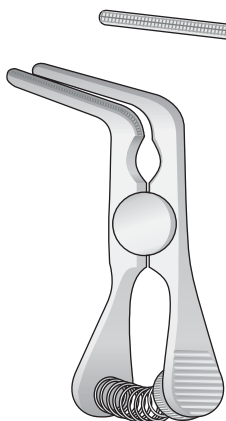
**FB-61**  
90 mm

DE BAKEY-CAROTIS  
**FB-61**  
90 mm



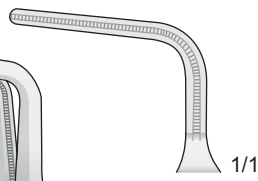
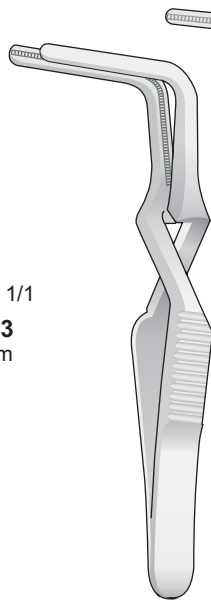
**FB-62**  
100 mm

DE BAKEY-SATINSKY  
**FB-62**  
100 mm



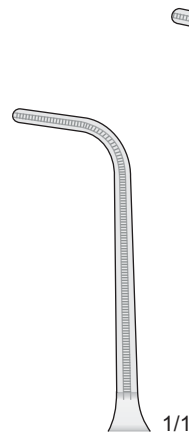
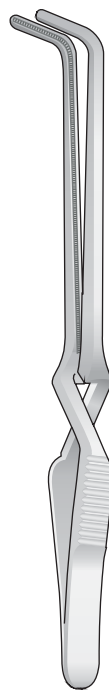
**FB-63**  
50 mm

GLOVER  
**FB-63**  
50 mm



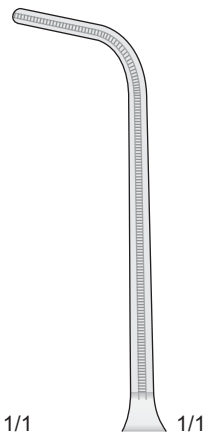
**FB-64**  
70 mm

SANTULLI  
**FB-64**  
70 mm



**FB-65**  
90 mm

**FB-65/FB-66**



**FB-66**  
110 mm



Pinze  
atraumatiche

Atraumatic  
vessel clamps

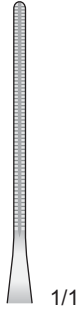
Atraumatische  
Gefäßklemmen

Pinces vasculaires  
atrauma

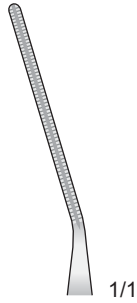
Pinzas vasculares  
atraumáticas

Pinze atraumatiche per neonati e bambini  
Atraumatic Vessel clamps for babies and children  
Atraumatische Gefäßklemmen für Säuglinge und Kinder  
Pinces vasculaires atraumatiques pour enfants  
Pinzas vasculares atraumáticas para niños

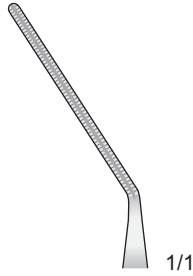
Modelli estremamente fini  
Delicate - Fein - Fins - Finas



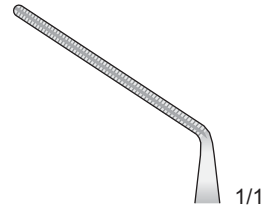
**FB-241**  
140 mm



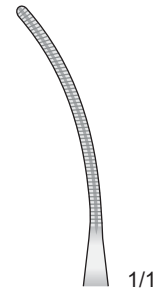
**FB-242**  
140 mm



**FB-243**  
140 mm



**FB-244**  
130 mm



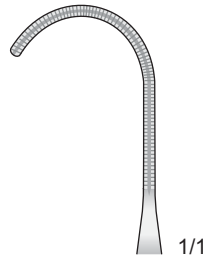
**FB-245**  
140 mm



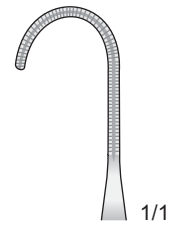
**FB-246**  
130 mm



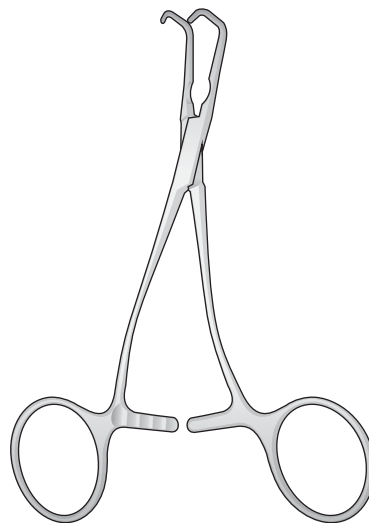
**FB-247**  
130 mm



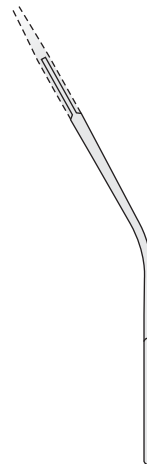
**FB-248**  
140 mm



**FB-249**  
135 mm



**FB-241/FB249**  
130 mm





Pinze  
atraumatiche

Atraumatic  
vessel clamps

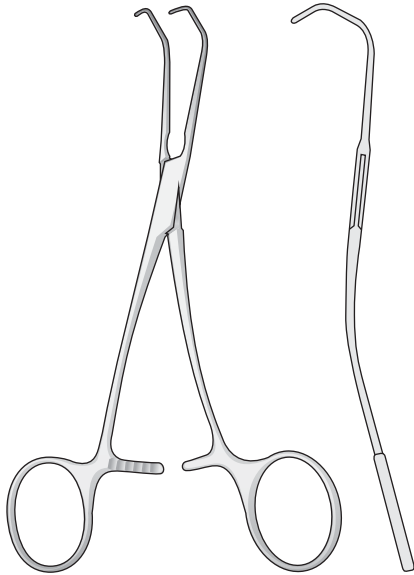
Atraumatische  
Gefäßklemmen

Pinces vasculaires  
atrauma

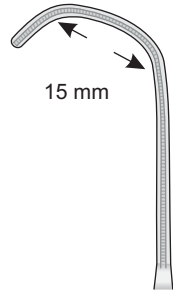
Pinzas vasculares  
atraumaticas



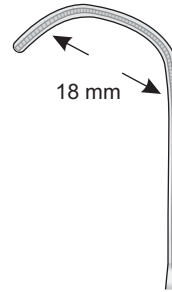
Atraumatiche  
Atraumatic  
Atraumatische  
Atraumatiques  
Atraumaticas



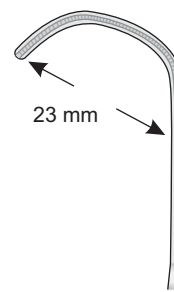
CASTANEDA  
FB-236/FB-239  
155 mm



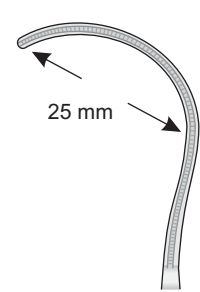
FB-236  
48 mm



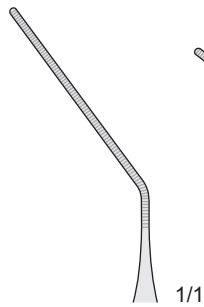
FB-237  
52 mm



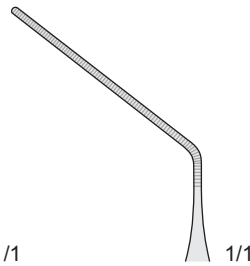
FB-238  
56 mm



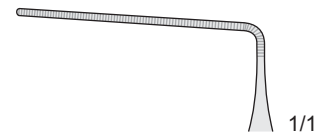
FB-239  
50 mm



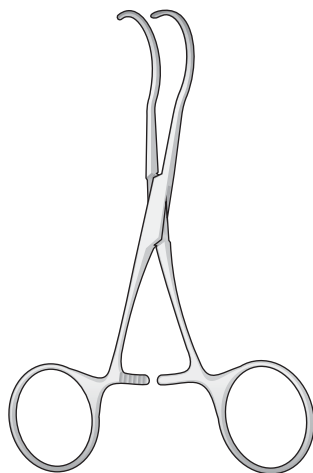
FB-251



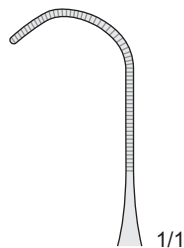
FB-252



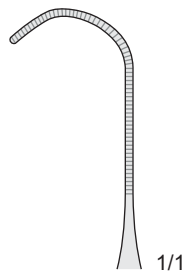
FB-253



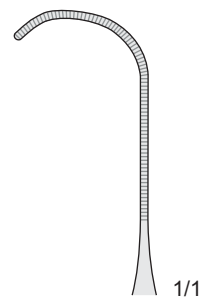
CASTANEDA  
FB-251/FD-257  
120 mm



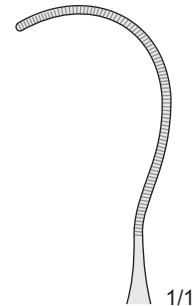
FB-254



FB-255



FB-256

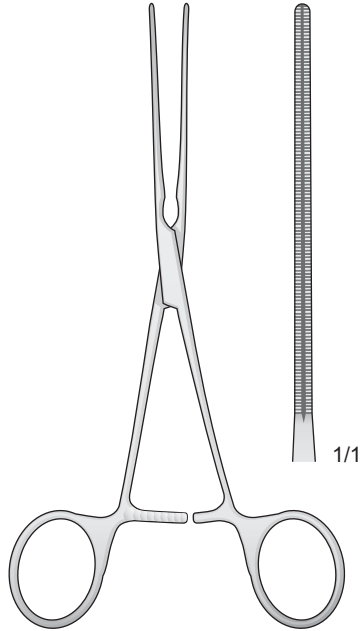


FB-257

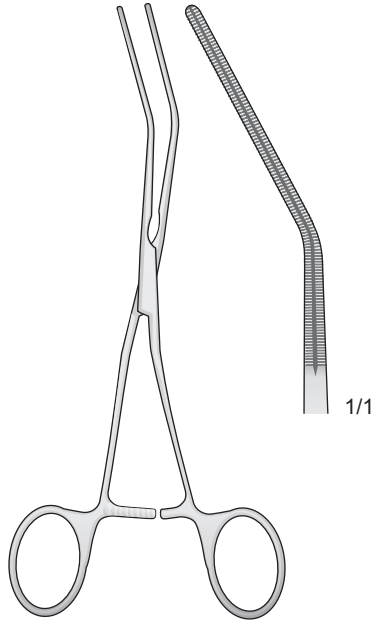




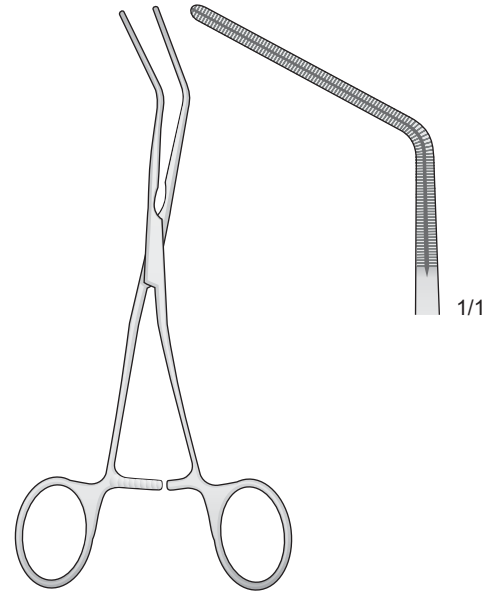
Pinze per neonati e bambini  
Atraumatic vessel clamps for babies and children  
Säugling - und Kinderklemmen  
Pinces-clamps pour nouveaux-nés et enfants  
Pinzas vasculares atraumáticas para niños



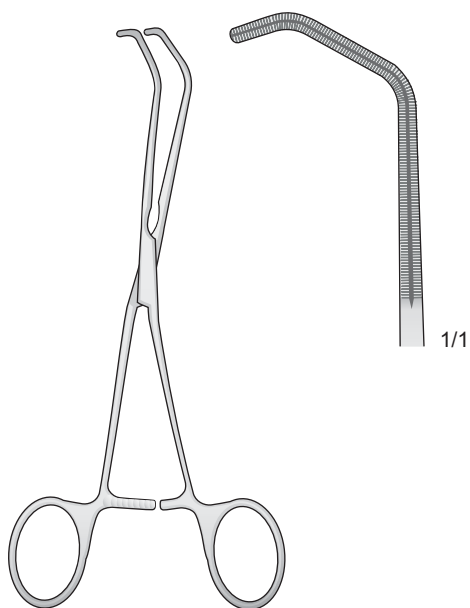
**FB-211**  
165 mm



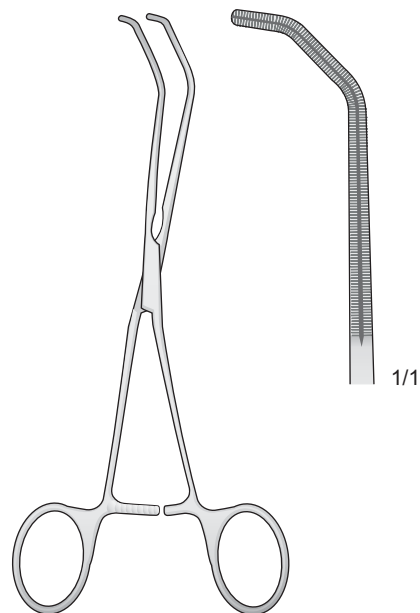
**FB-212**  
160 mm



**FB-213**  
150 mm



**FB-214**  
150 mm



**FB-215**  
155 mm



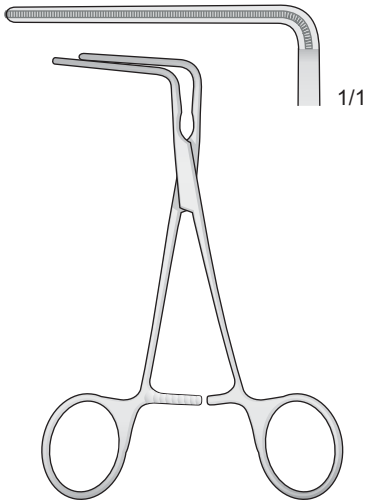
Pinze vascolari  
atraumatiche

Atraumatic  
vessel clamps

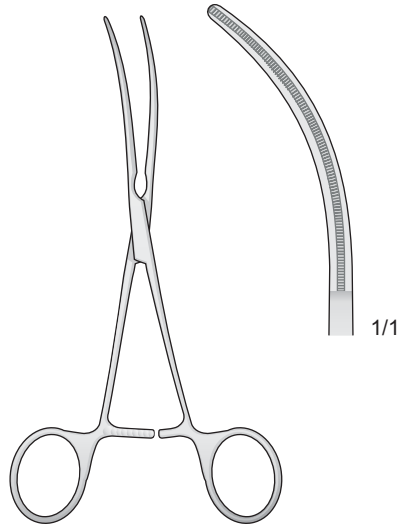
Atraumatische  
Gefäßklemmen

Pinces hémostatiques  
atraumatiques

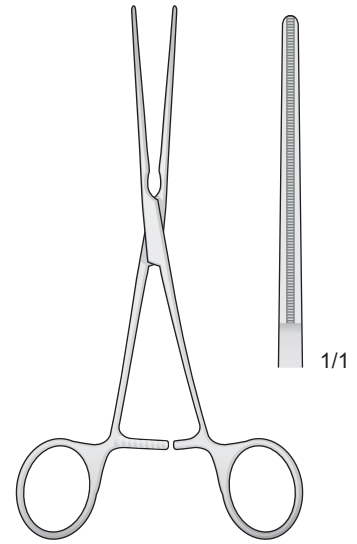
Pinzas vasculares  
atraumáticas



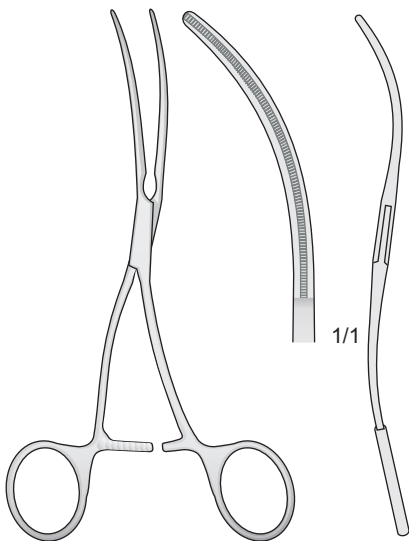
De BAKEY  
**FB-201**  
100 mm



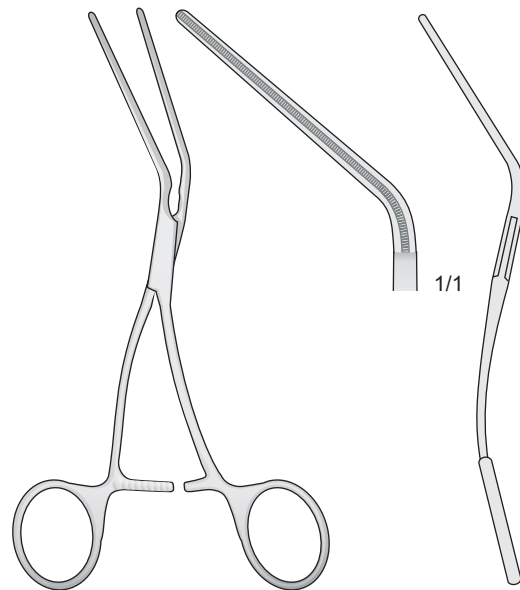
De BAKEY  
**FB-202**  
110 mm



De BAKEY  
**FB-203**  
120 mm



De BAKEY  
**FB-204**  
120 mm



De BAKEY  
**FB-205**  
130 mm



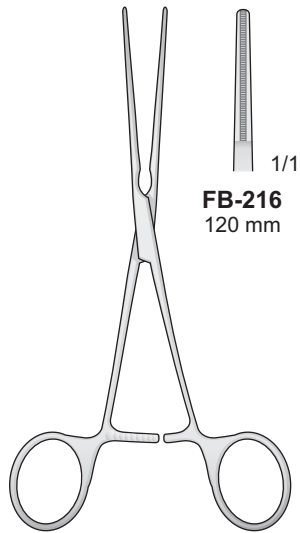
Pinze  
atraumatiche

Atraumatic  
vessel clamps

Atraumatische  
Gefäßklemmen

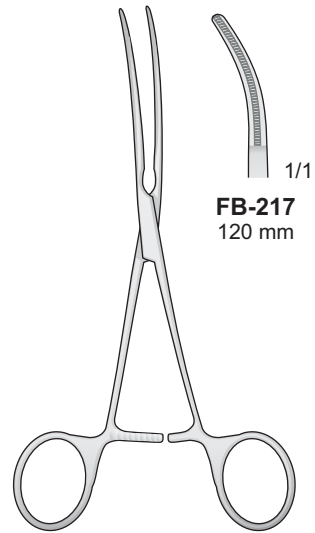
Pincers vasculaires  
atrauma

Pinzas vasculares  
atraumáticas



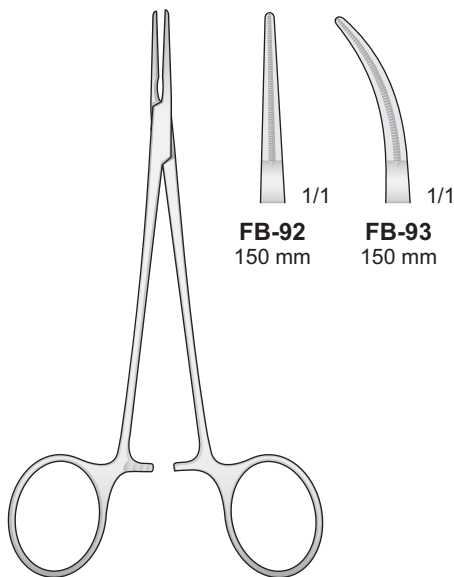
**FB-216**  
120 mm

De BAKEY - MOSQUITO  
**FB-216**  
120 mm



**FB-217**  
120 mm

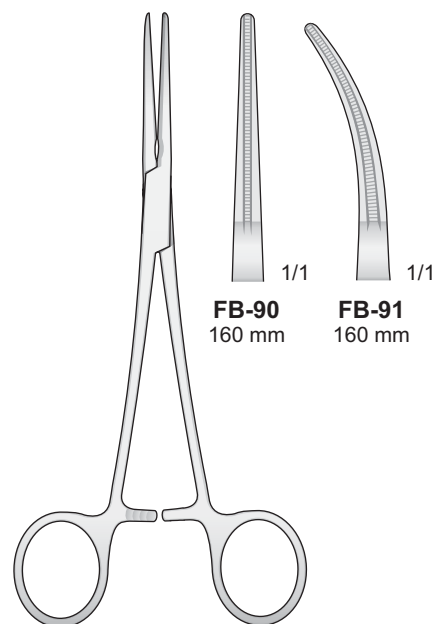
De BAKEY - MOSQUITO  
**FB-217**  
120 mm



**FB-92**  
150 mm

**FB-93**  
150 mm

De BAKEY - MOSQUITO  
**FB-92/FB-93**  
150 mm



**FB-90**  
160 mm

**FB-91**  
160 mm

De BAKEY - RANKIN  
**FB-90/FB-91**  
160 mm



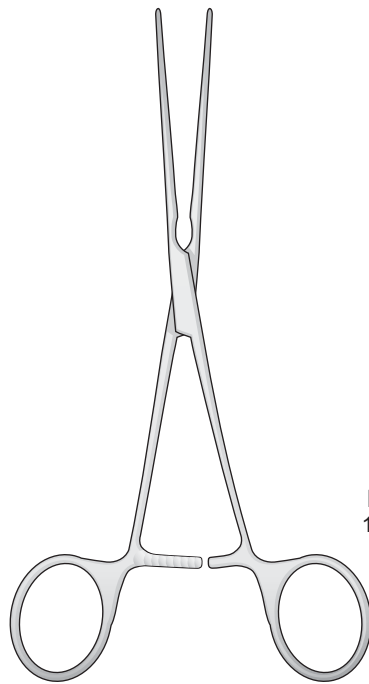
Pinze vascolari  
atraumatiche

Atraumatic  
vessel clamps

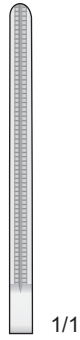
Atraumatische  
Gefäßklemmen

Pinces hémostatiques  
atraumatiques

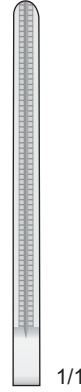
Pinzas vasculares  
atraumáticas



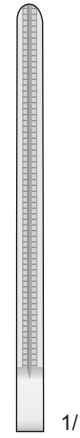
De BAKEY - PEAN  
FB-45/FB-49



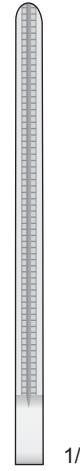
**FB-45**  
140 mm



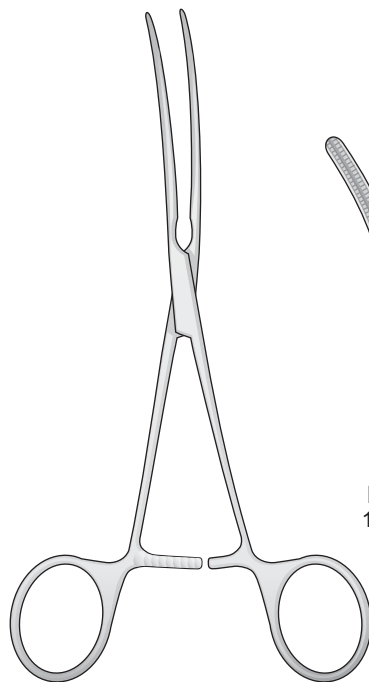
**FB-47**  
160 mm



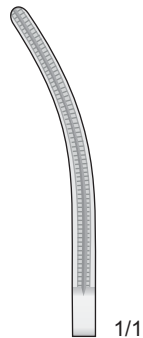
**FB-48**  
180 mm



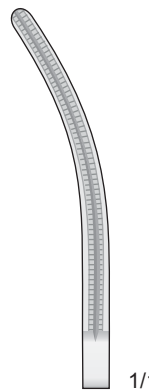
**FB-49**  
200 mm



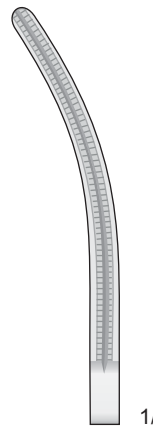
De BAKEY - PEAN  
FB-55/FB-59



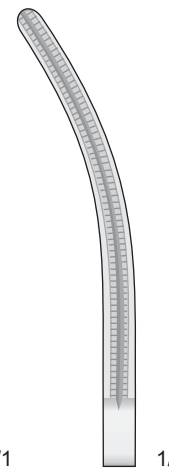
**FB-55**  
140 mm



**FB-57**  
160 mm



**FB-58**  
180 mm



**FB-59**  
200 mm



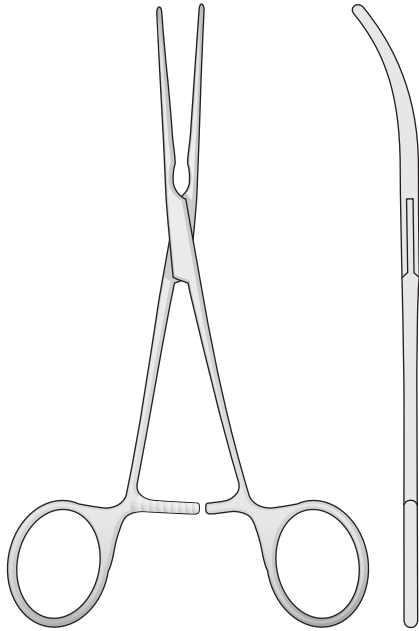
Pinze vascolari  
atraumatiche

Atraumatic  
vessel clamps

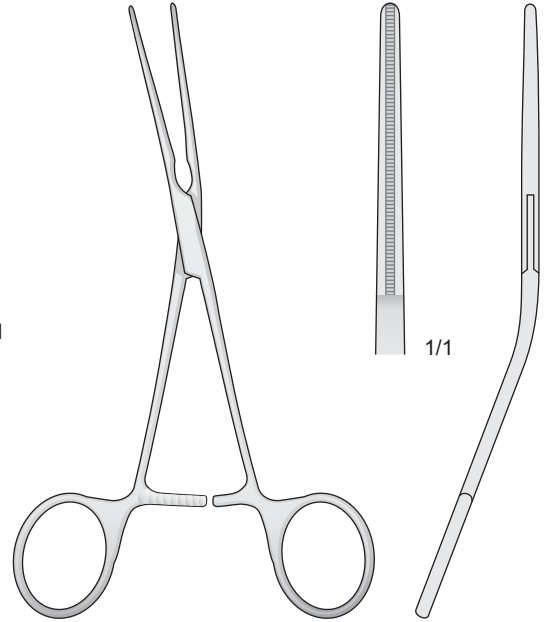
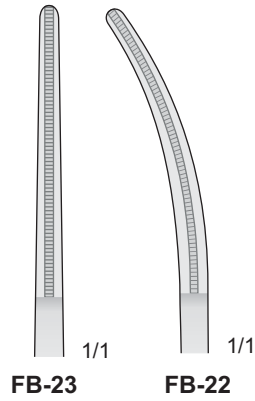
Atraumatische  
Gefäßklemmen

Pinces hémostatiques  
atraumatiques

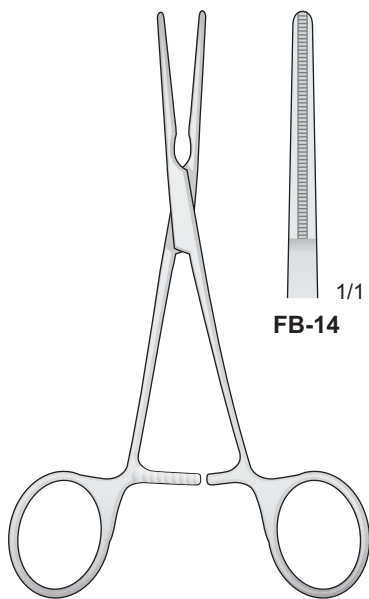
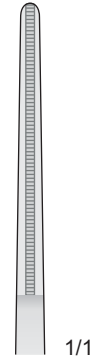
Pinzas vasculares  
atraumáticas



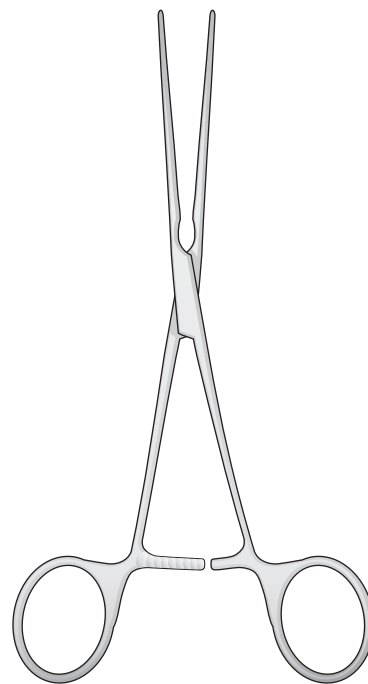
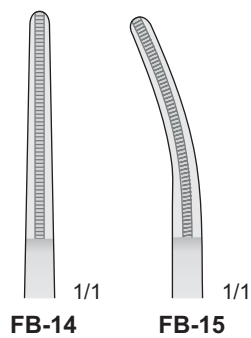
De BAKEY  
**FB-22/FB-23**  
165 mm



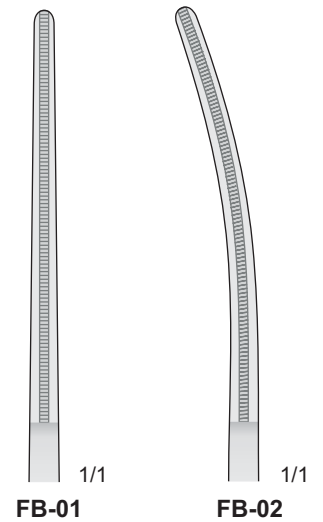
De BAKEY  
**FB-24**  
165 mm



De BAKEY - BAINBRIDGE  
**FB-14/FB-15**  
155 mm



De BAKEY - BAINBRIDGE  
**FB-01/FB-02**  
180 mm





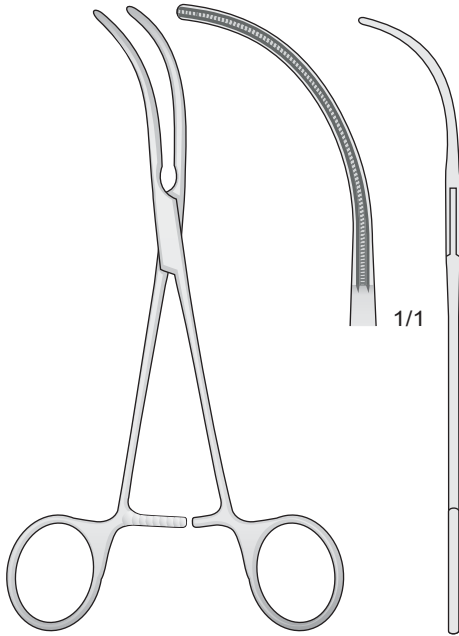
Pinze vascolari  
atraumatiche

Atraumatic  
vessel clamps

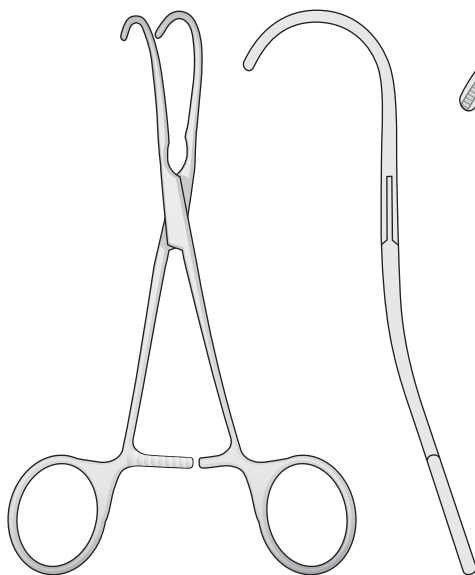
Atraumatische  
Gefäßklemmen

Pinces hémostatiques  
atraumatiques

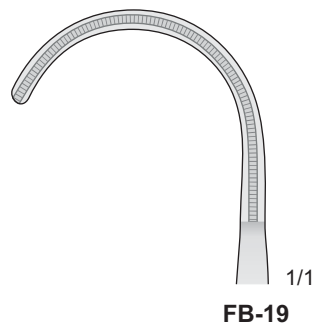
Pinzas vasculares  
atraumáticas



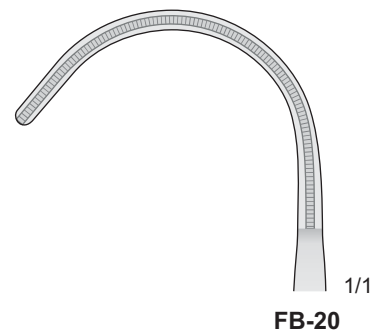
De BAKEY  
**FB-133**  
160 mm



De BAKEY  
**FB-19/FB-20**  
150 mm



**FB-19**



**FB-20**



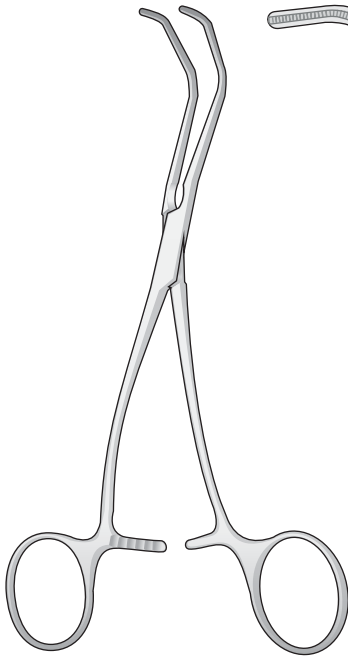
Pinze vascolari  
atraumatiche

Atraumatic  
vessel clamps

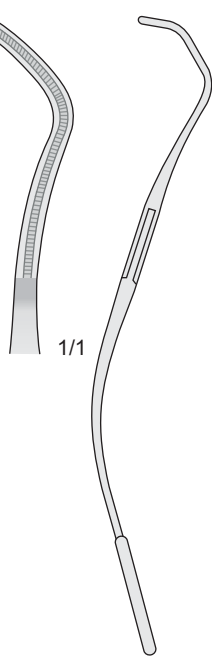
Atraumatische  
Gefäßklemmen

Pinces hémostatiques  
atraumatiques

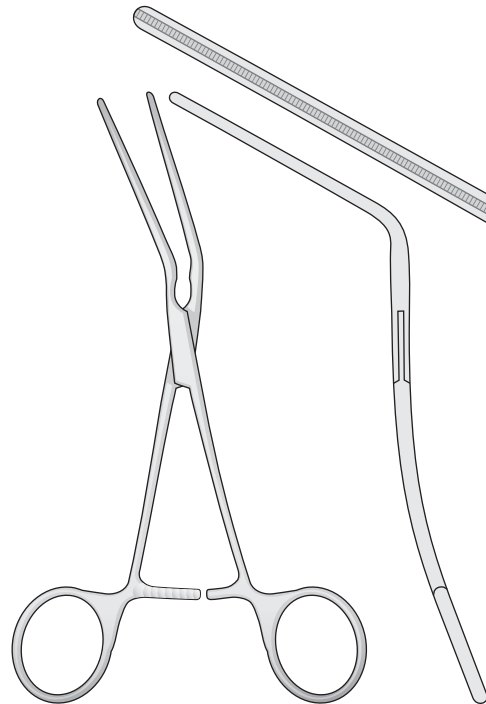
Pinzas vasculares  
atraumáticas



De-BAKEY  
**FB-191**  
170 mm



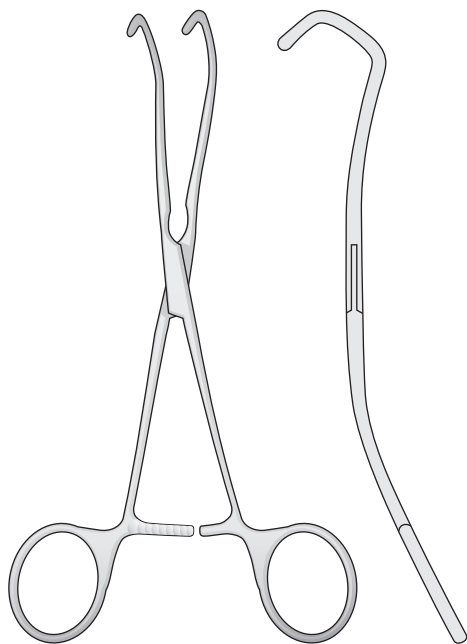
1/1



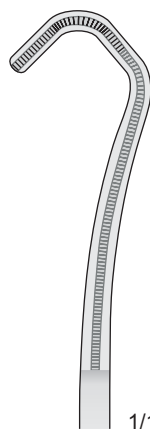
De BAKEY  
**FB-21**  
165 mm



1/1

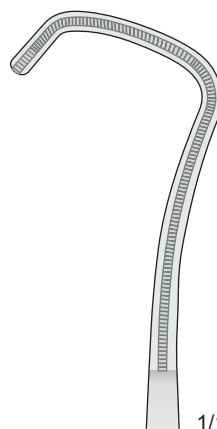


DERRA  
**FB-03/FB-04**  
170 mm



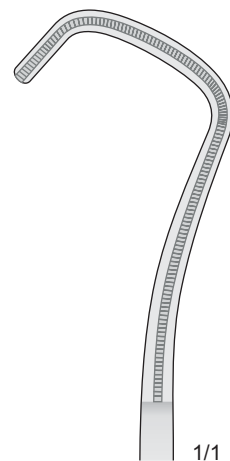
**FB-03**

1/1



**FB-04**

1/1



**FB-05**

1/1



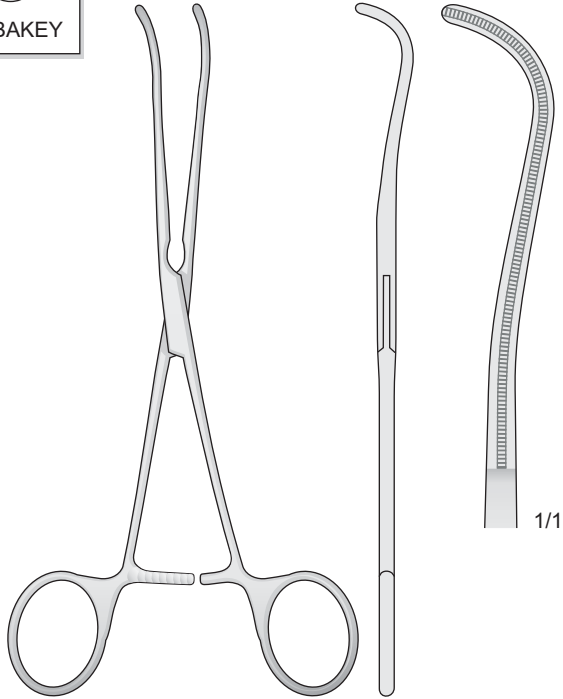
Pinze vascolari  
atraumatiche

Atraumatic  
vessel clamps

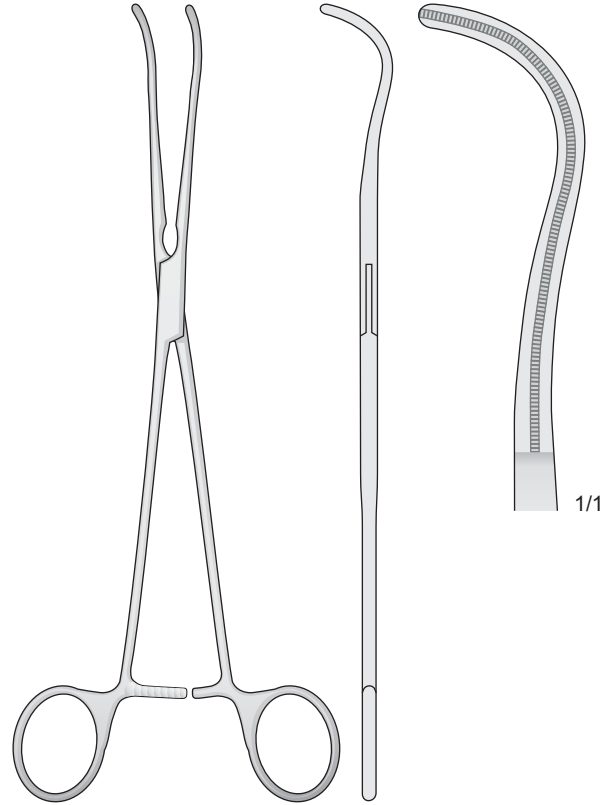
Atraumatische  
Gefäßklemmen

Pinces hémostatiques  
atraumatiques

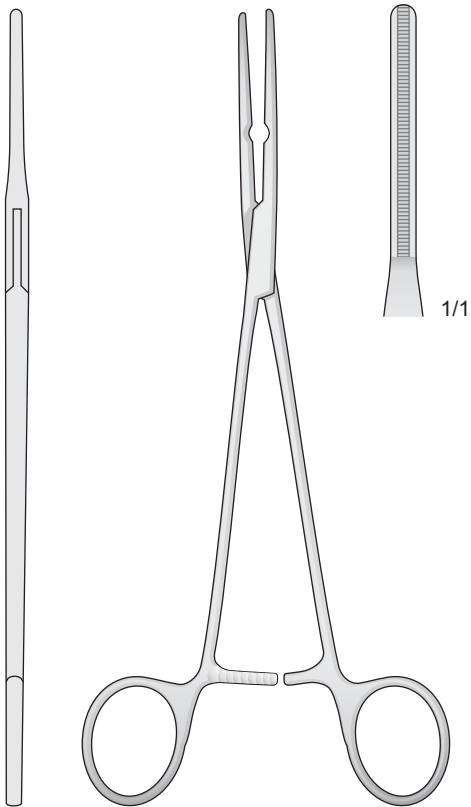
Pinzas vasculares  
atraumáticas



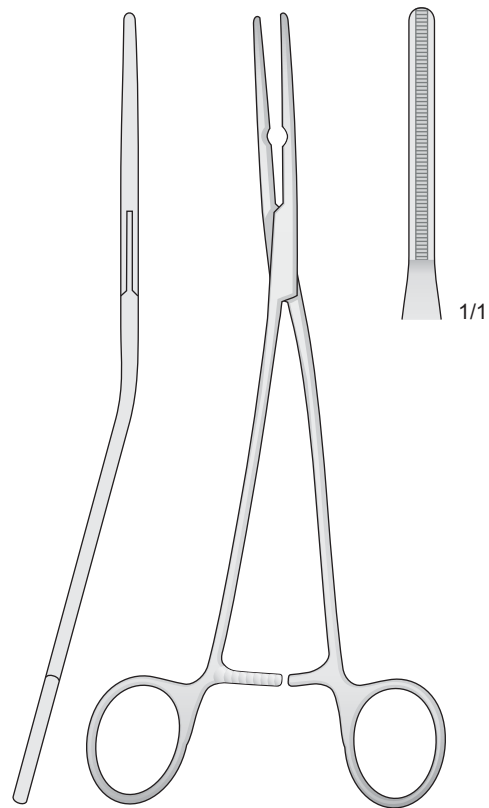
De BAKEY  
**FB-18**  
190 mm



De BAKEY  
**FB-37**  
230 mm



De BAKEY  
**FB-35**  
215 mm



De BAKEY  
**FB-36**  
215 mm





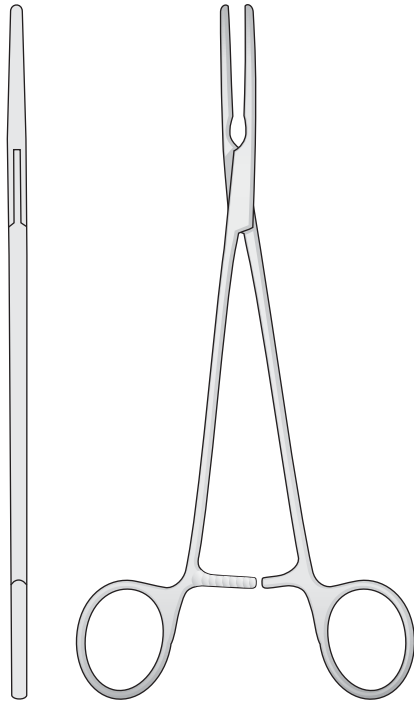
Pinze vascolari  
atraumatiche

Atraumatic  
vessel clamps

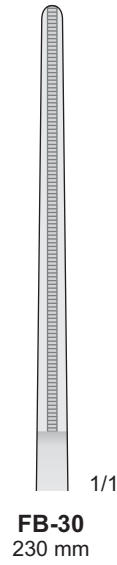
Atraumatische  
Gefäßklemmen

Pinces hémostatiques  
atraumatiques

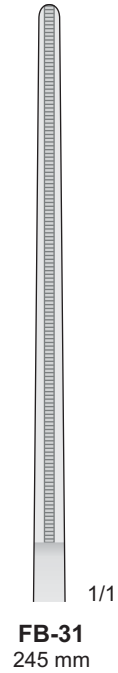
Pinzas vasculares  
atraumáticas



1/1  
**FB-29**  
200 mm

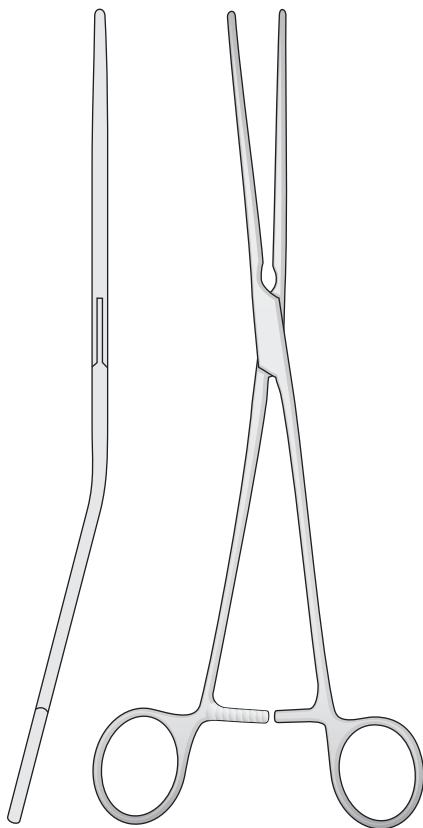


1/1  
**FB-30**  
230 mm

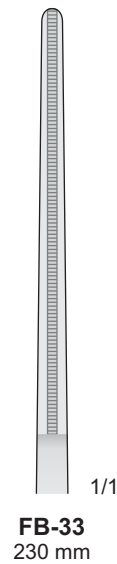


1/1  
**FB-31**  
245 mm

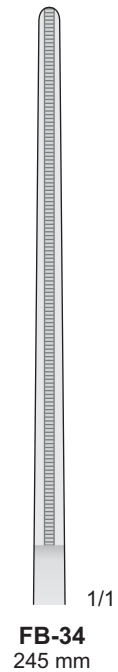
De BAKEY  
**FB-29/FB-31**



1/1  
**FB-32**  
200 mm



1/1  
**FB-33**  
230 mm



1/1  
**FB-34**  
245 mm

De BAKEY  
**FB-32/FB-34**



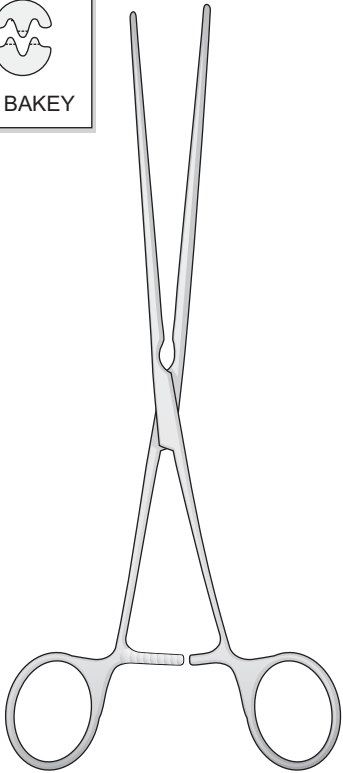
Pinze vascolari  
atraumatiche

Atraumatic  
vessel clamps

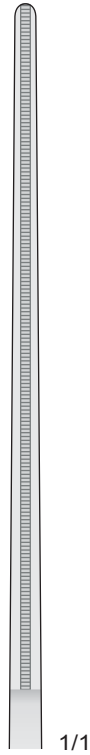
Atraumatische  
Gefäßklemmen

Pinces hémostatiques  
atraumatiques

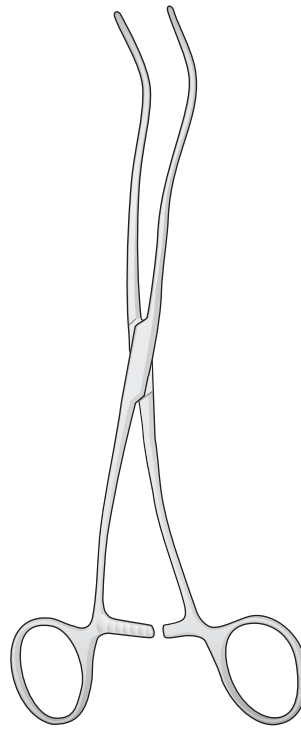
Pinzas vasculares  
atraumáticas



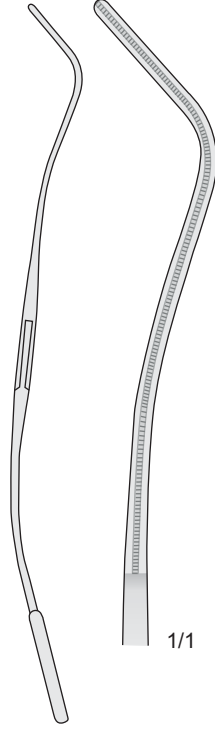
De BAKEY  
**FB-09**  
220 mm



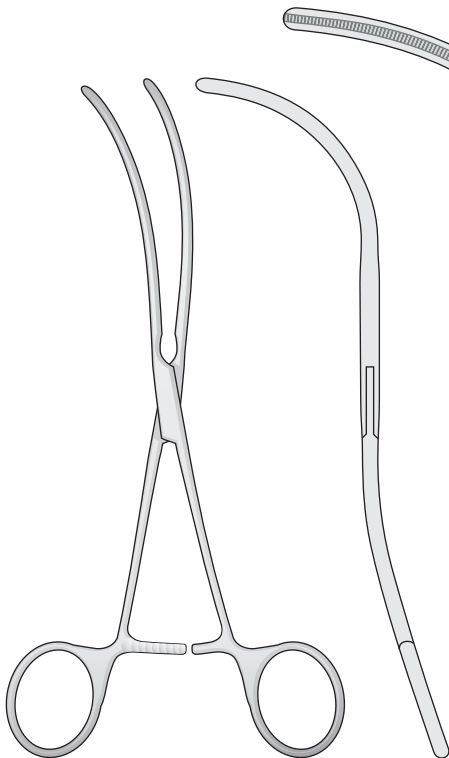
1/1



De BAKEY  
**FB-17**  
200 mm



1/1

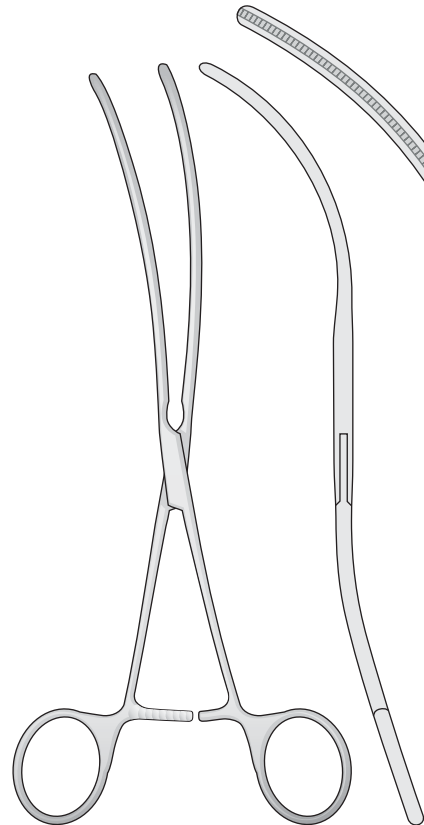


De BAKEY  
**FB-08**  
180 mm

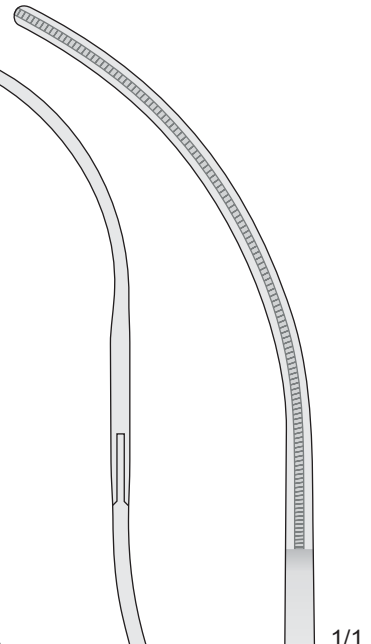


1/1

**FB-08**



De BAKEY  
**FB-10**  
200 mm



1/1

**FB-10**



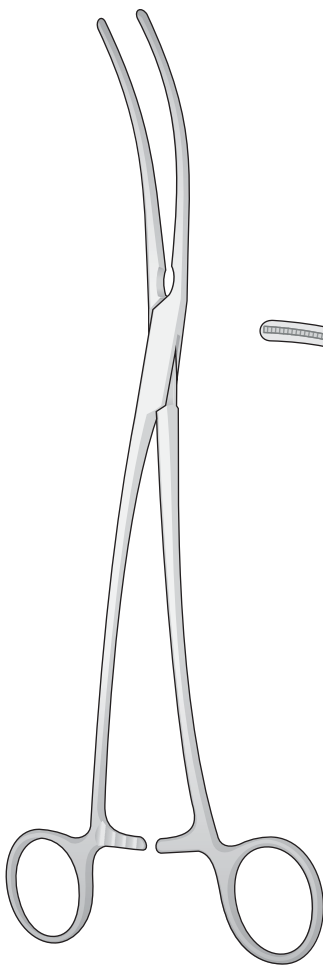
Pinze vascolari  
atraumatiche

Atraumatic  
vessel clamps

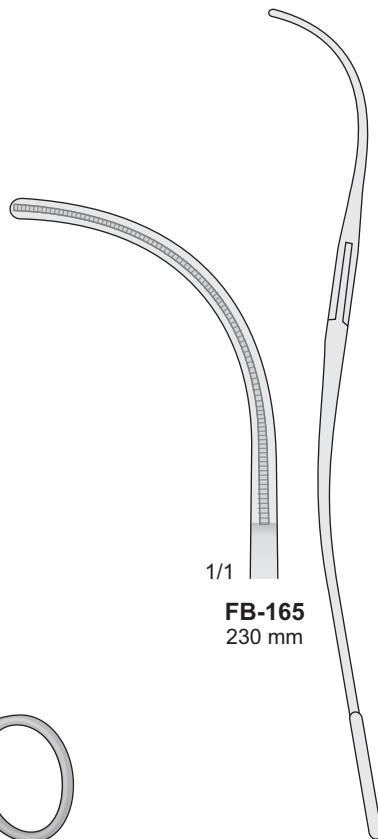
Atraumatische  
Gefäßklemmen

Pinces hémostatiques  
atraumatiques

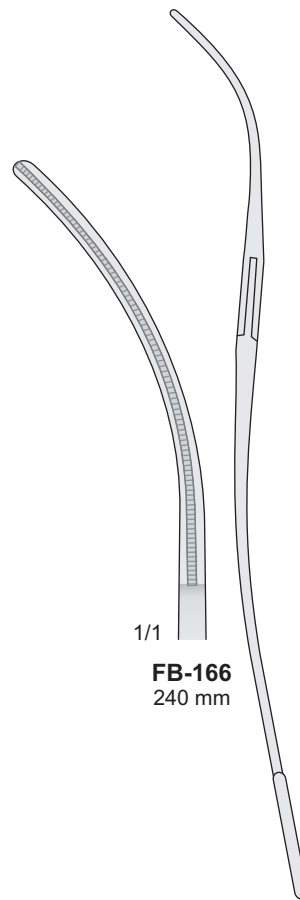
Pinzas vasculares  
atraumáticas



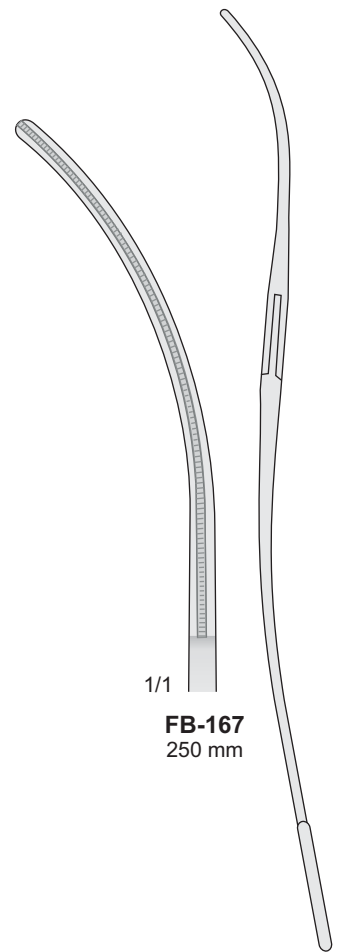
De BAKEY-BAHNSON  
FB-165/FB-167



1/1  
FB-165  
230 mm



1/1  
FB-166  
240 mm



1/1  
FB-167  
250 mm



Pinze vascolari  
atraumatiche

Atraumatic  
vessel clamps

Atraumatische  
Gefäßklemmen

Pinces hémostatiques  
atraumatiques

Pinzas vasculares  
atraumáticas



De BAKEY



**FB-38**  
250 mm

**FB-39**  
270 mm

**FB-40**  
280 mm

**FB-44**  
330 mm

De BAKEY  
**FB-38/FB-44**



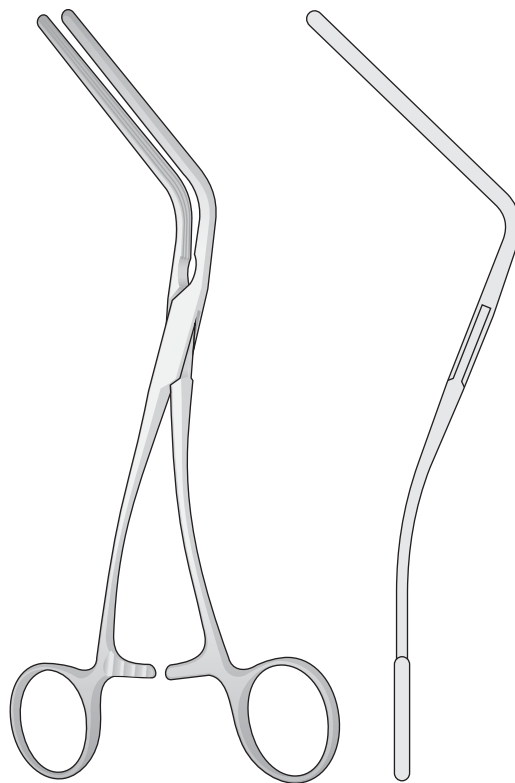
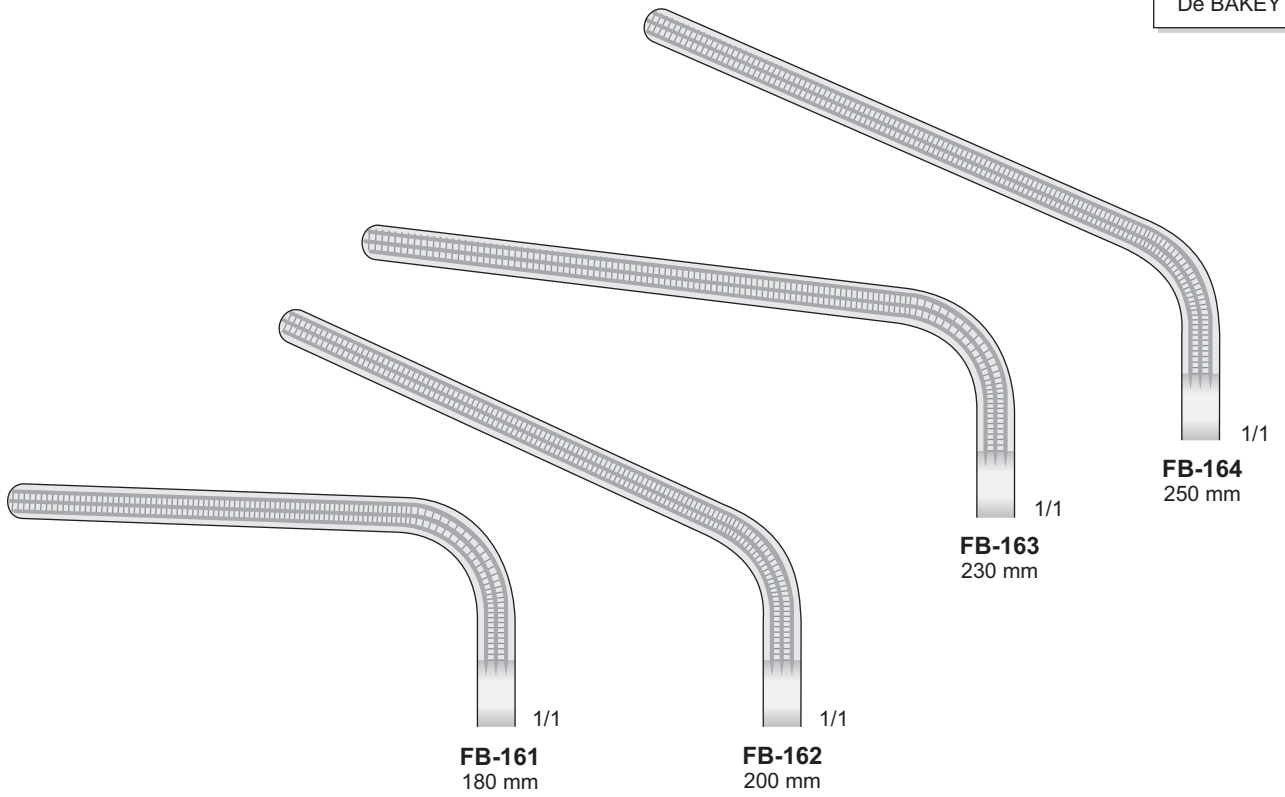
Pinze vascolari  
atraumatiche

Atraumatic  
vessel clamps

Atraumatische  
Gefäßklemmen

Pinces hémostatiques  
atraumatiques

Pinzas vasculares  
atraumáticas



MORRIS-De BAKEY  
FB-161/FB-164



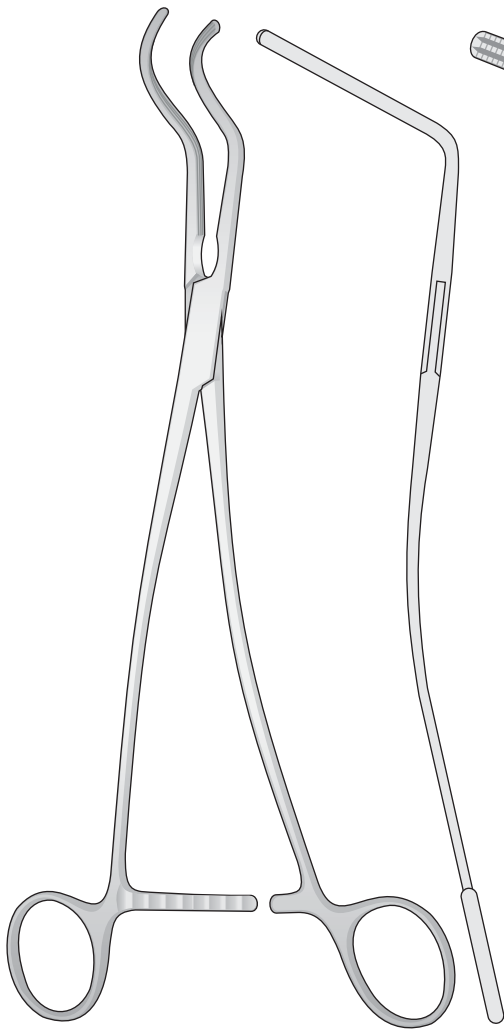
Pinze vascolari  
atraumatiche

Atraumatic  
vessel clamps

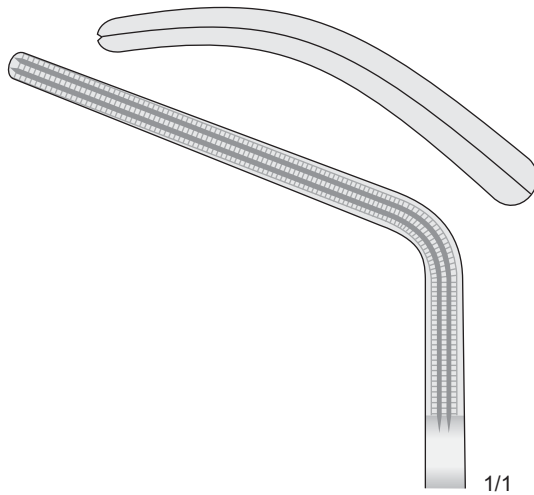
Atraumatische  
Gefäßklemmen

Pinces hémostatiques  
atraumatiques

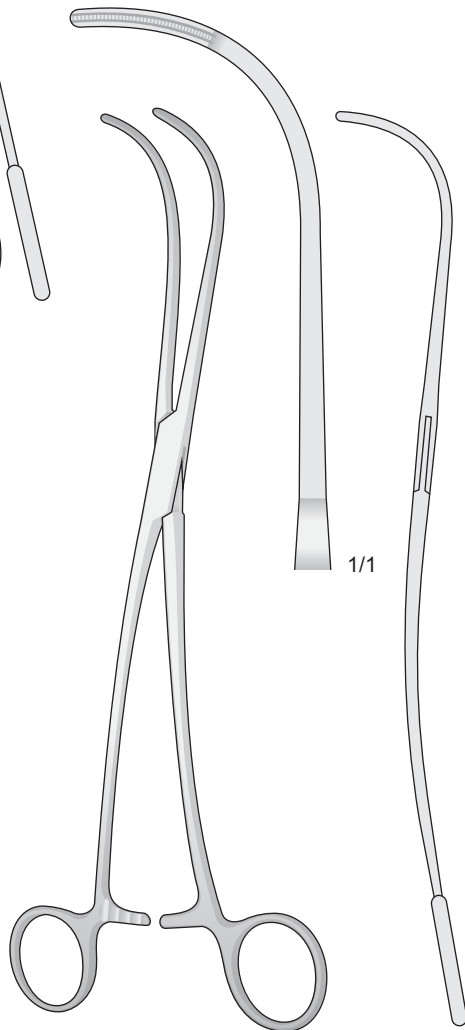
Pinzas vasculares  
atraumáticas



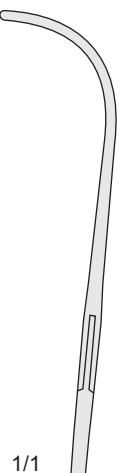
De BAKEY  
**FB-140**  
270 mm



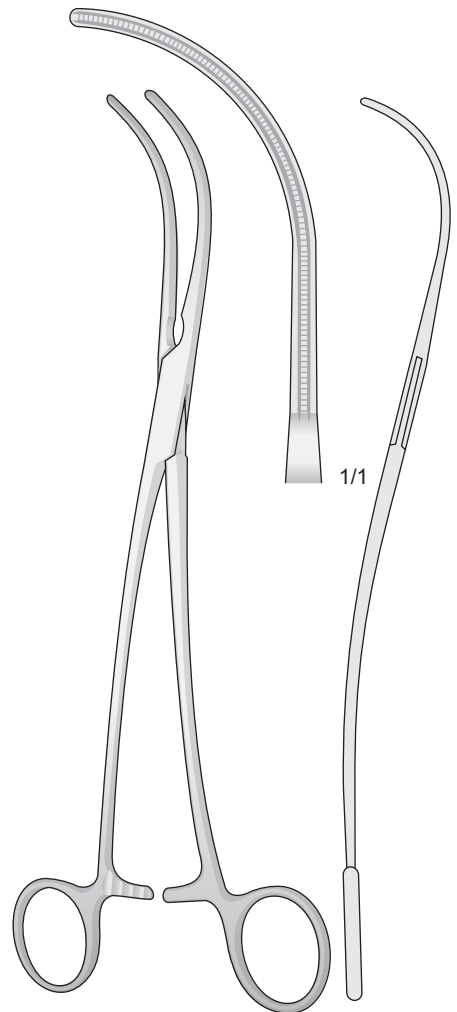
1/1



De BAKEY  
**FB-141**  
240 mm



1/1



De BAKEY  
**FB-142**  
240 mm



1/1



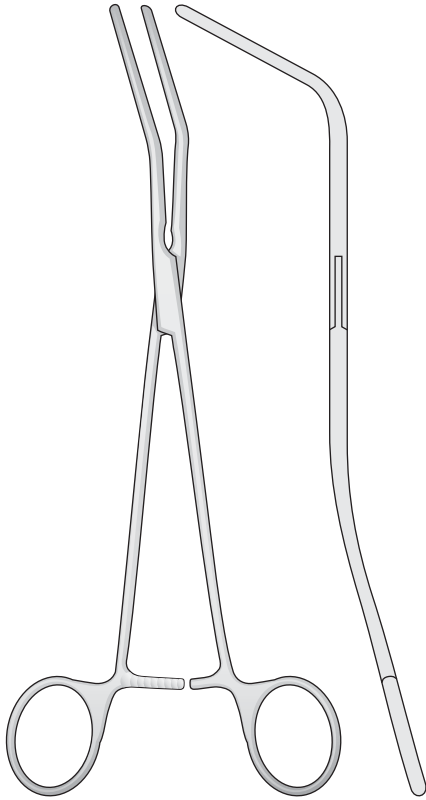
Pinze vascolari  
atraumatiche

Atraumatic  
vessel clamps

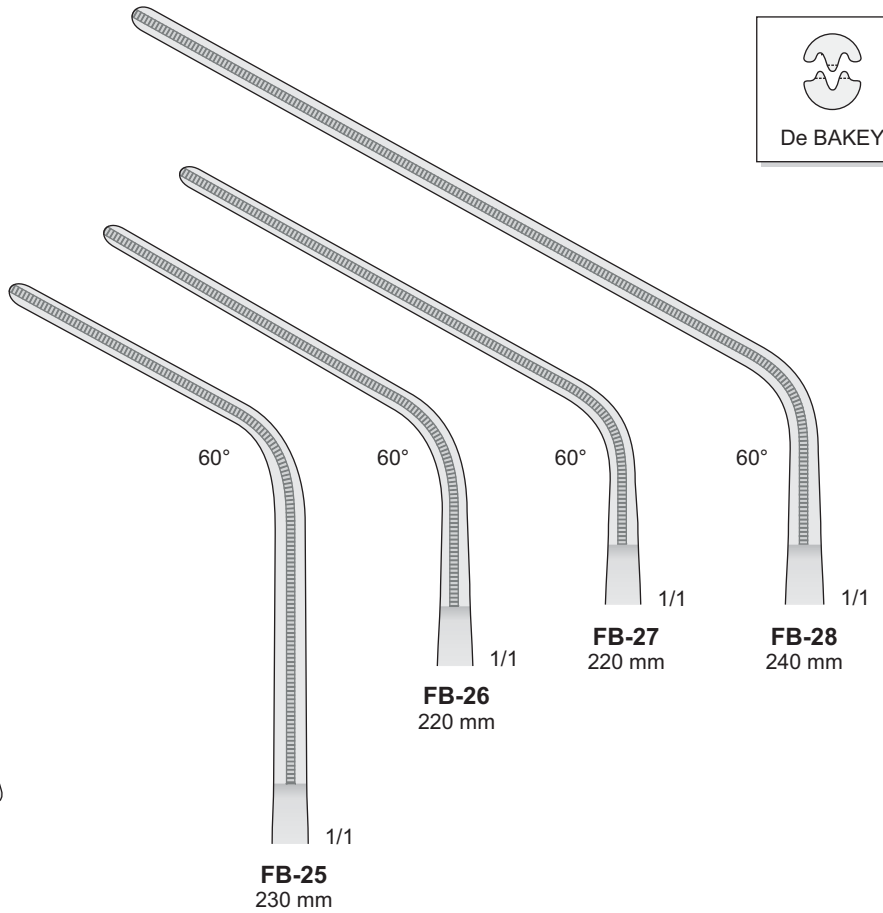
Atraumatische  
Gefäßklemmen

Pinces hémostatiques  
atraumatiques

Pinzas vasculares  
atraumáticas



De BAKEY  
FB-25/FB-28

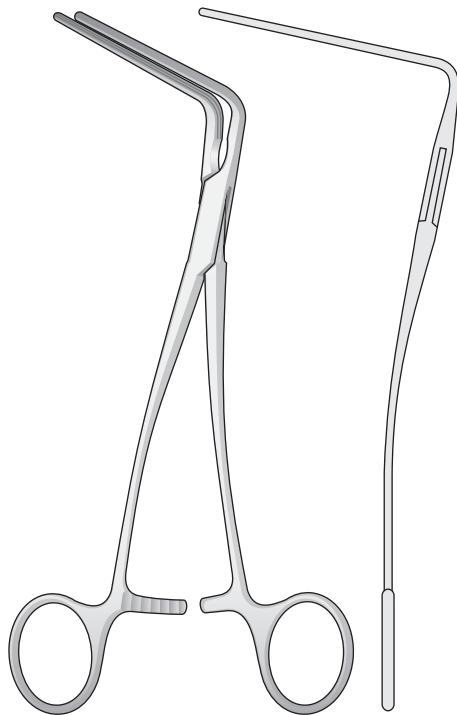


FB-25  
230 mm

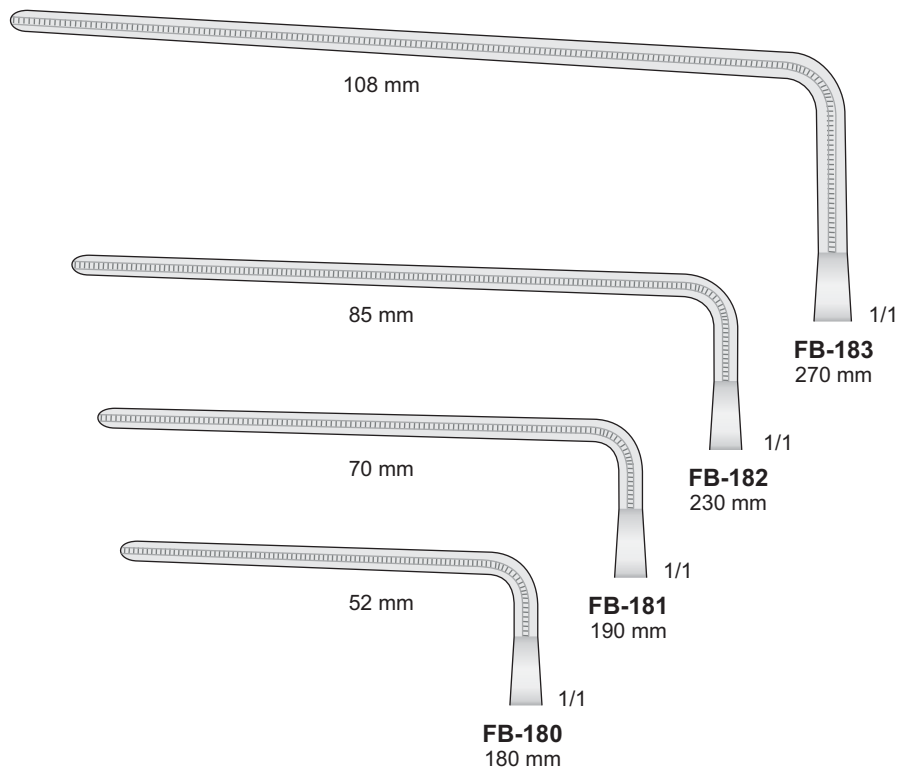
FB-26  
220 mm

FB-27  
220 mm

FB-28  
240 mm



De-BAKEY  
FB-180/FB-183



FB-180  
180 mm

FB-181  
190 mm

FB-182  
230 mm

FB-183  
270 mm



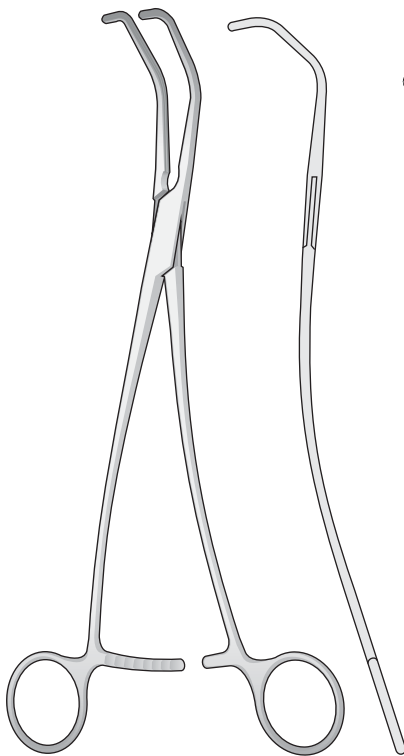
Pinze vascolari  
atraumatiche

Atraumatic  
vessel clamps

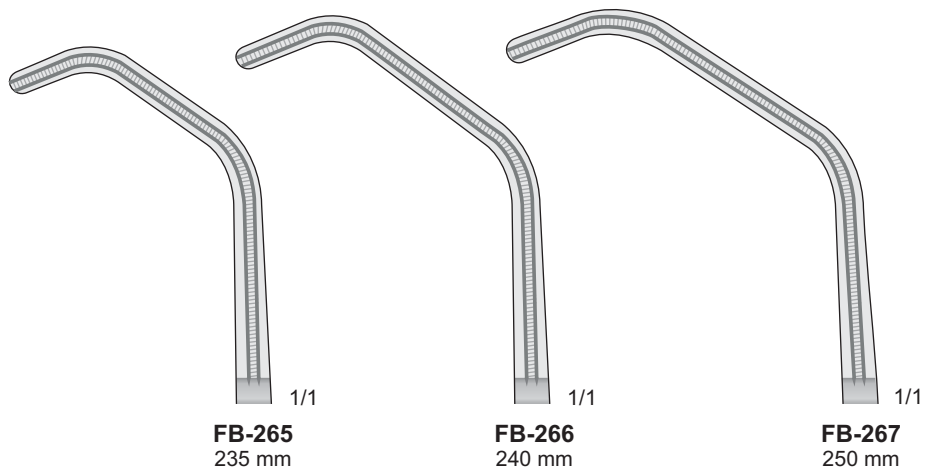
Atraumatische  
Gefäßklemmen

Pinces hémostatiques  
atraumatiques

Pinzas vasculares  
atraumáticas



De BAKEY-SATINSKY  
FB-265/FB-267







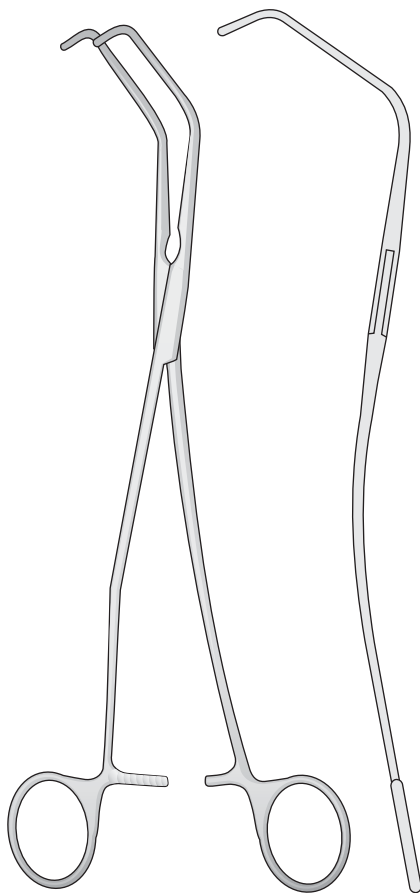
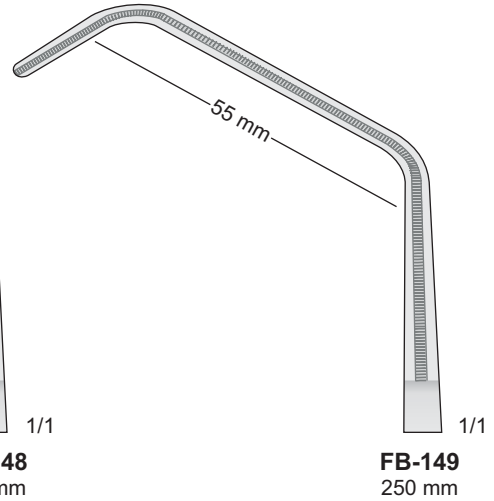
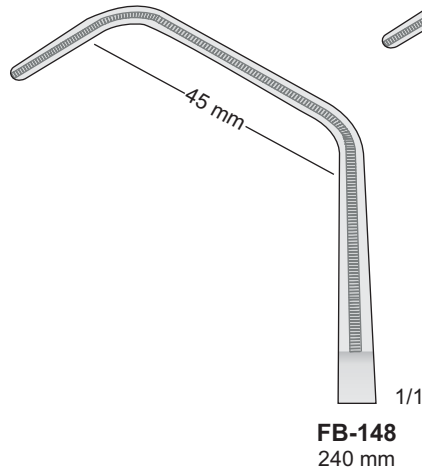
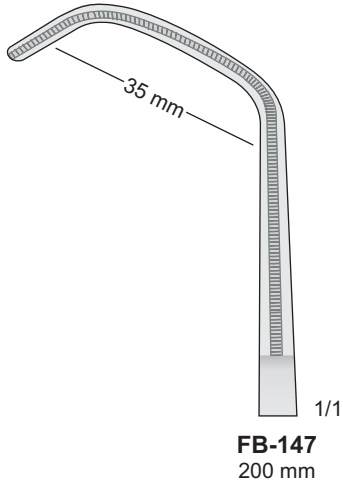
Pinze vascolari  
atraumatiche

Atraumatic  
vessel clamps

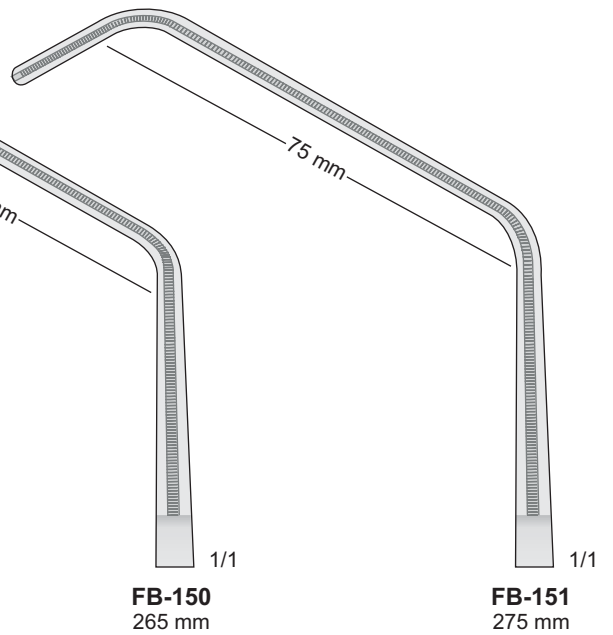
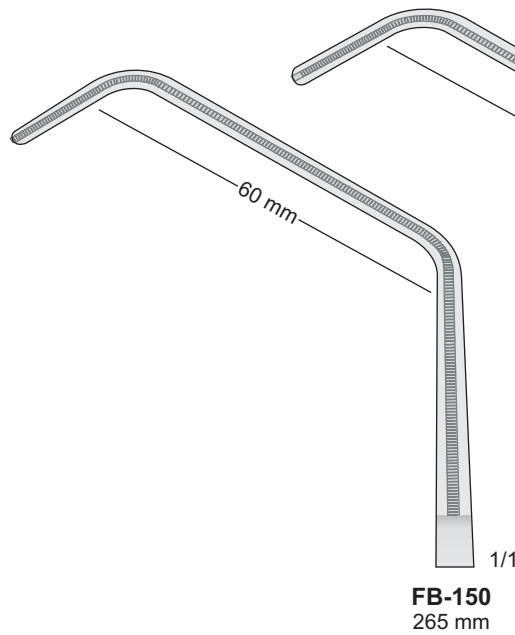
Atraumatische  
Gefäßklemmen

Pinces hémostatiques  
atraumatiques

Pinzas vasculares  
atraumáticas



De-BAKEY  
FB-147/FB-151





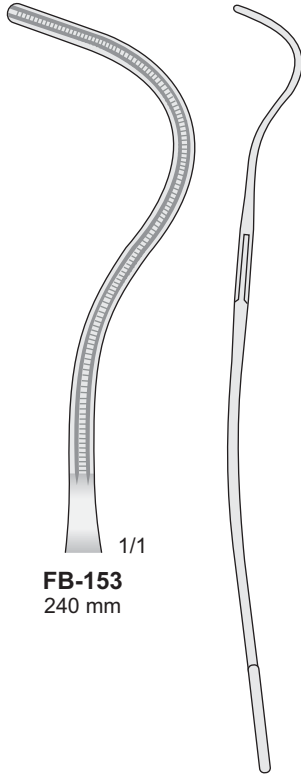
Pinze vascolari  
atraumatiche

Atraumatic  
vessel clamps

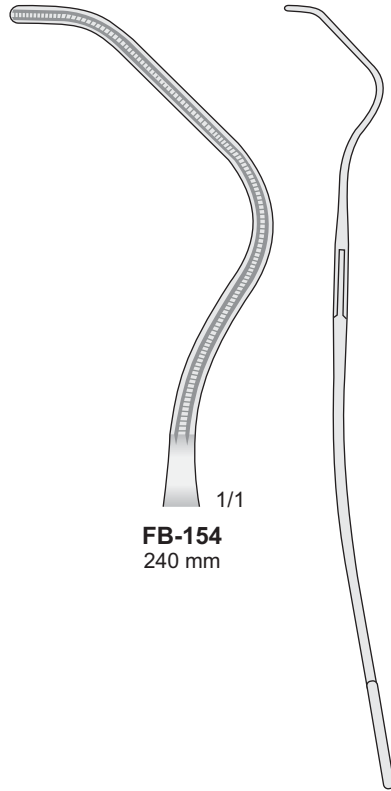
Atraumatische  
Gefäßklemmen

Pinces hémostatiques  
atraumatiques

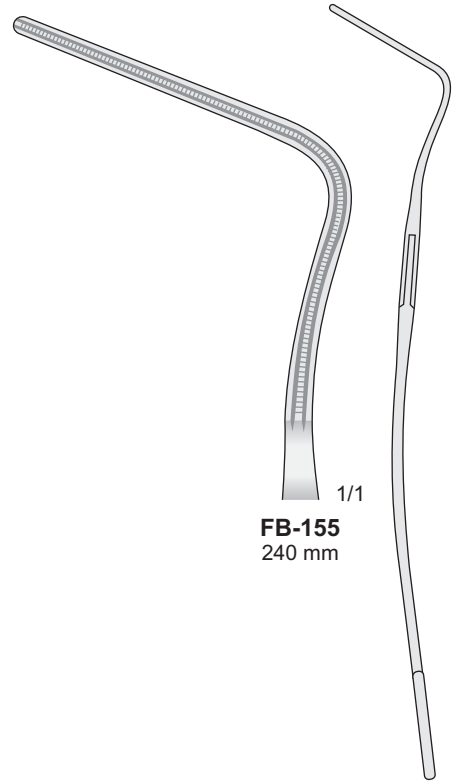
Pinzas vasculares  
atraumáticas



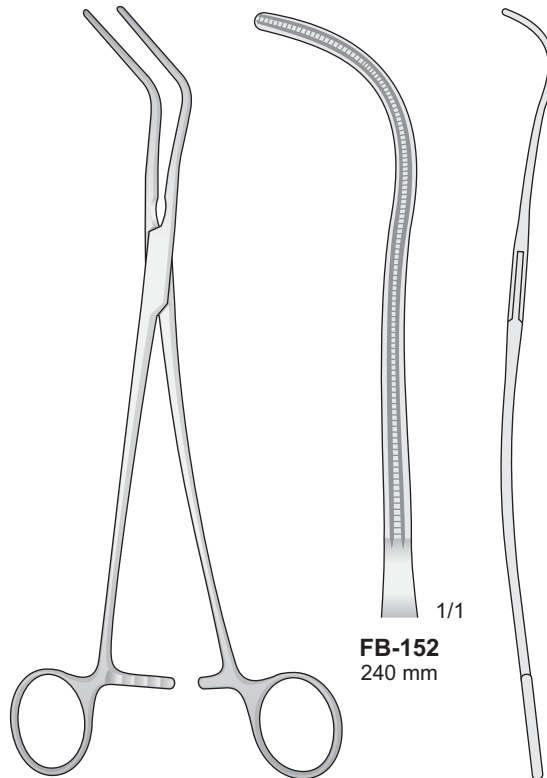
**FB-153**  
240 mm



**FB-154**  
240 mm



**FB-155**  
240 mm



**FB-152**  
240 mm

De BAKEY-HARKEN  
**FB-152/FB-155**



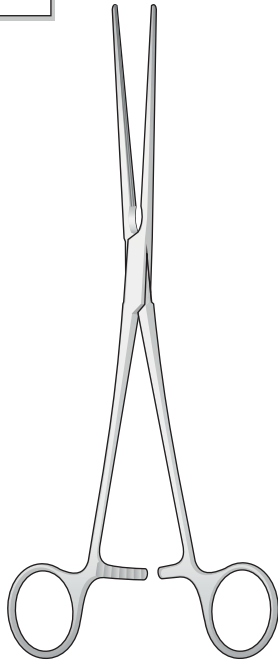
Pinze vascolari  
atraumatiche

Atraumatic  
vessel clamps

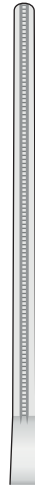
Atraumatische  
Gefäßklemmen

Pinces hémostatiques  
atraumatiques

Pinzas vasculares  
atraumáticas



De BAKEY  
FB-168/FB-171



1/1  
FB-168  
215 mm



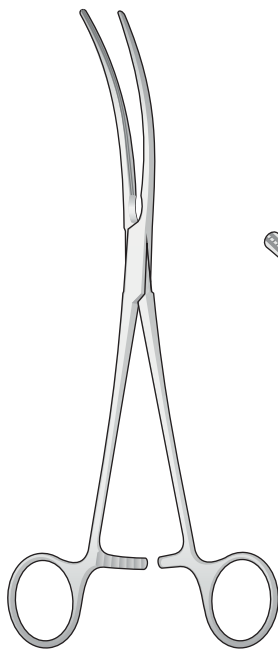
1/1  
FB-169  
230 mm



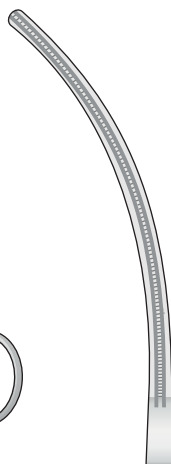
1/1  
FB-170  
270 mm



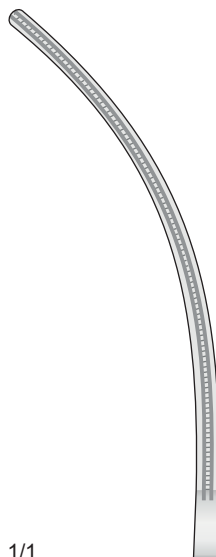
1/1  
FB-171  
315 mm



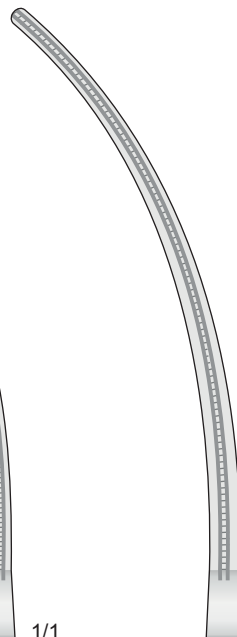
De BAKEY  
FB-172/FB-175



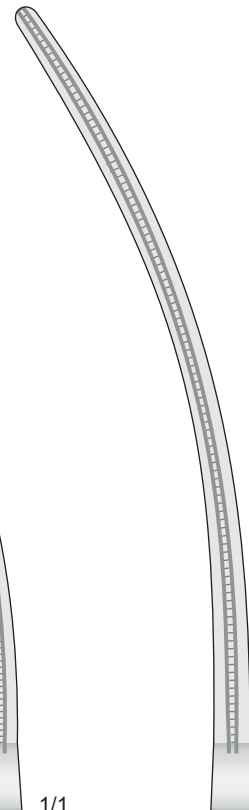
1/1  
FB-172  
215 mm



1/1  
FB-173  
230 mm



1/1  
FB-174  
270 mm



1/1  
FB-175  
310 mm



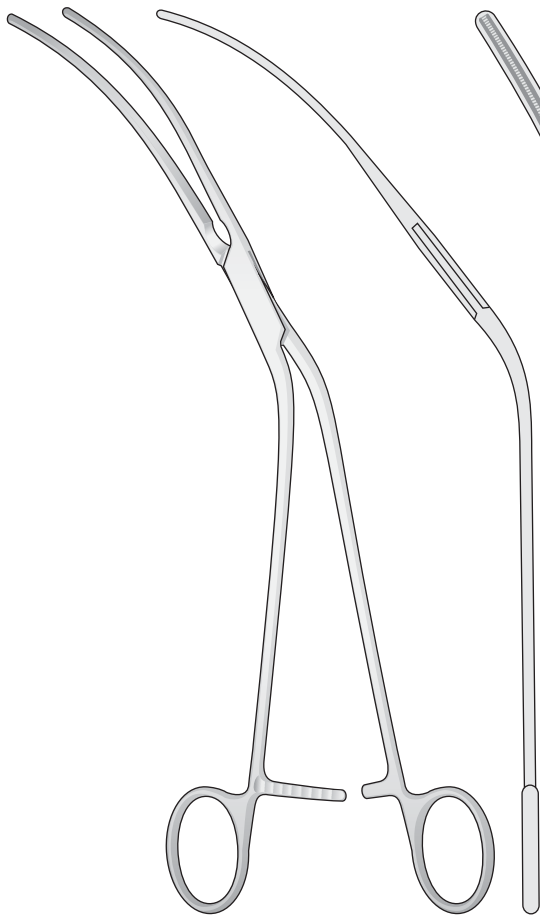
Pinze vascolari  
atraumatiche

Atraumatic  
vessel clamps

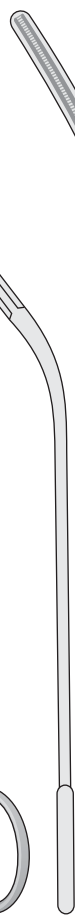
Atraumatische  
Gefäßklemmen

Pinces hémostatiques  
atraumatiques

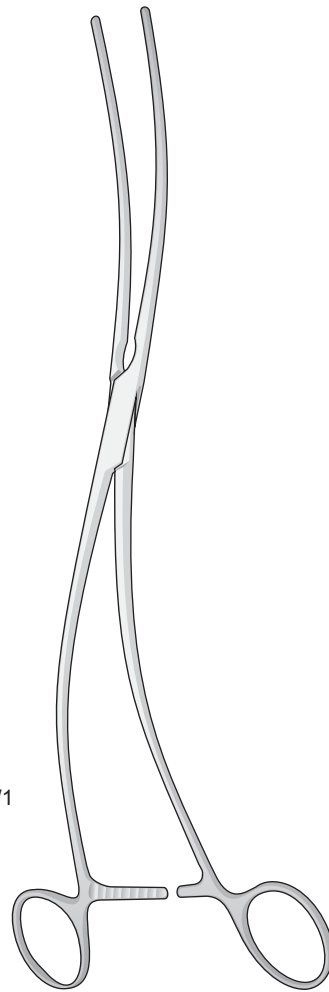
Pinzas vasculares  
atraumáticas



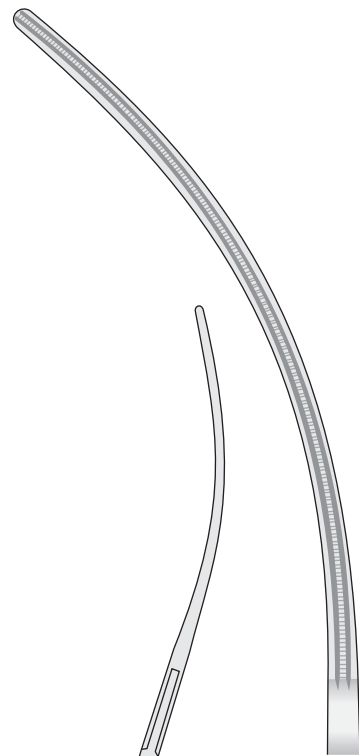
De BAKEY  
**FB-138**  
280 mm



1/1  
**FB-138**



**FB-139**  
300 mm



1/1



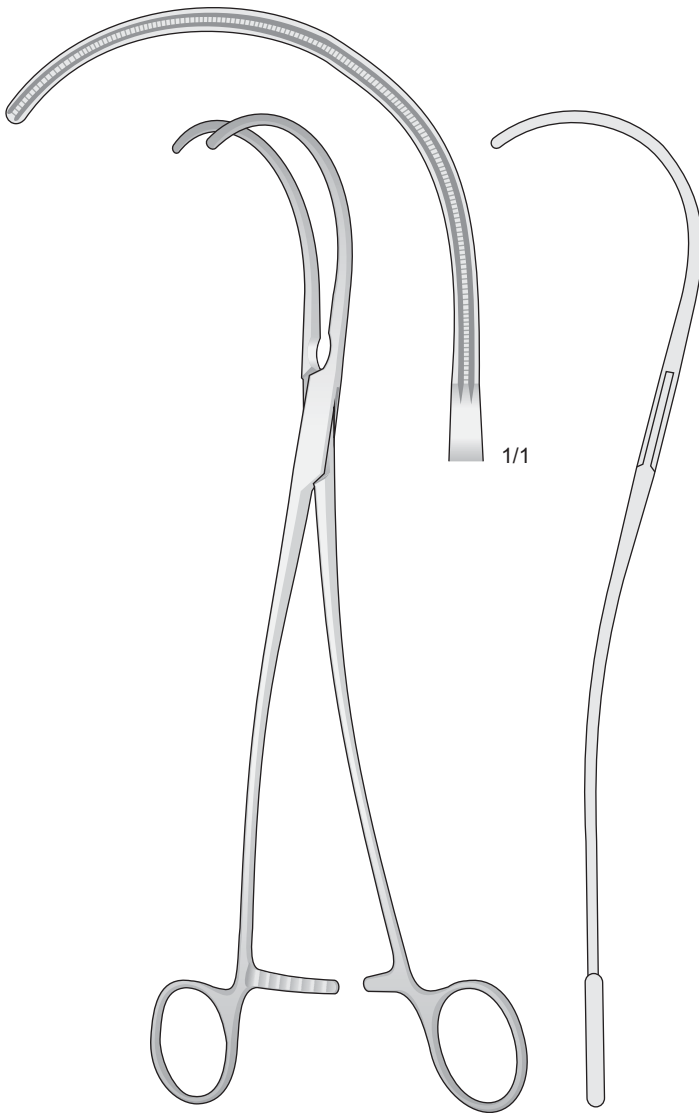
Pinze vascolari  
atraumatiche

Atraumatic  
vessel clamps

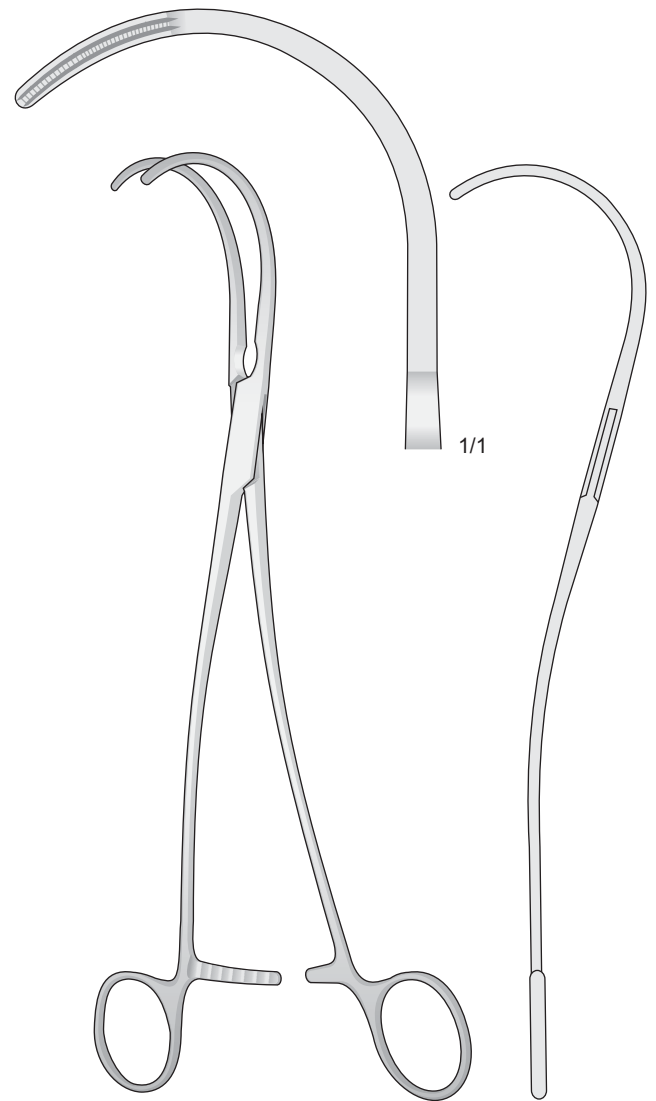
Atraumatische  
Gefäßklemmen

Pinces hémostatiques  
atraumatiques

Pinzas vasculares  
atraumáticas



De BAKEY  
**FB-143**  
260 mm



De BAKEY  
**FB-144**  
250 mm



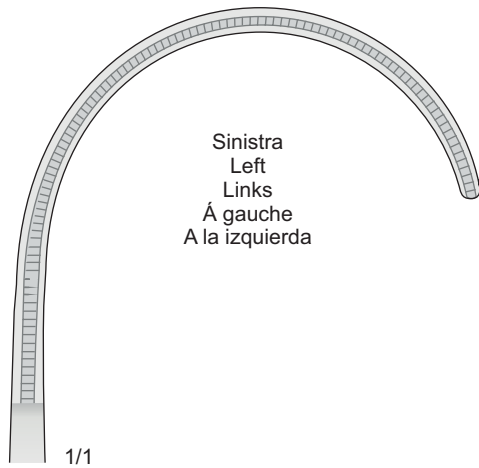
Pinze vascolari  
atraumatiche

Atraumatic  
vessel clamps

Atraumatische  
Gefäßklemmen

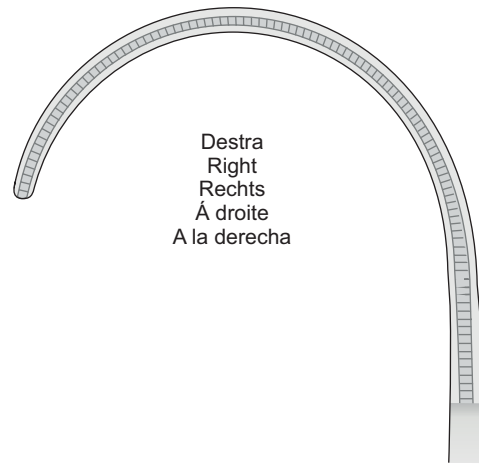
Pinces hémostatiques  
atraumatiques

Pinzas vasculares  
atraumáticas



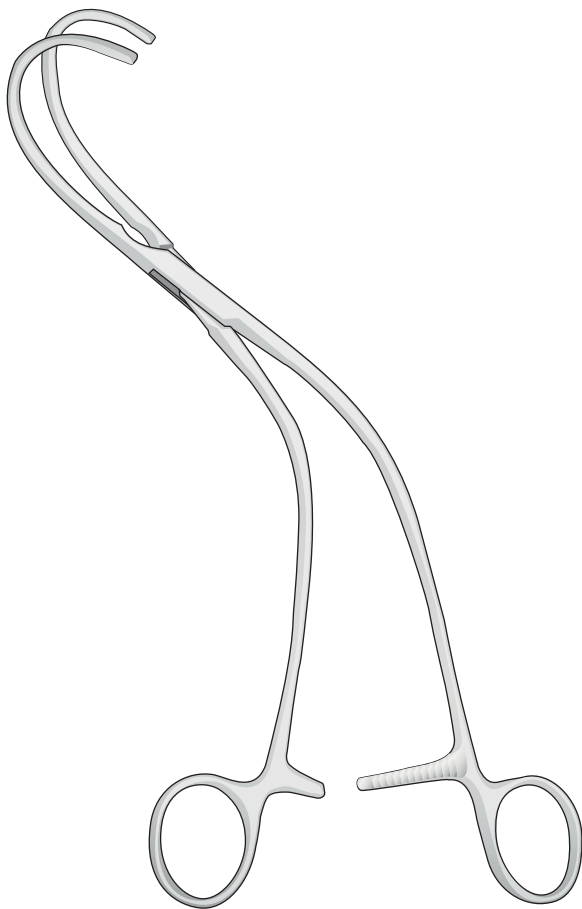
Sinistra  
Left  
Links  
À gauche  
A la izquierda

1/1

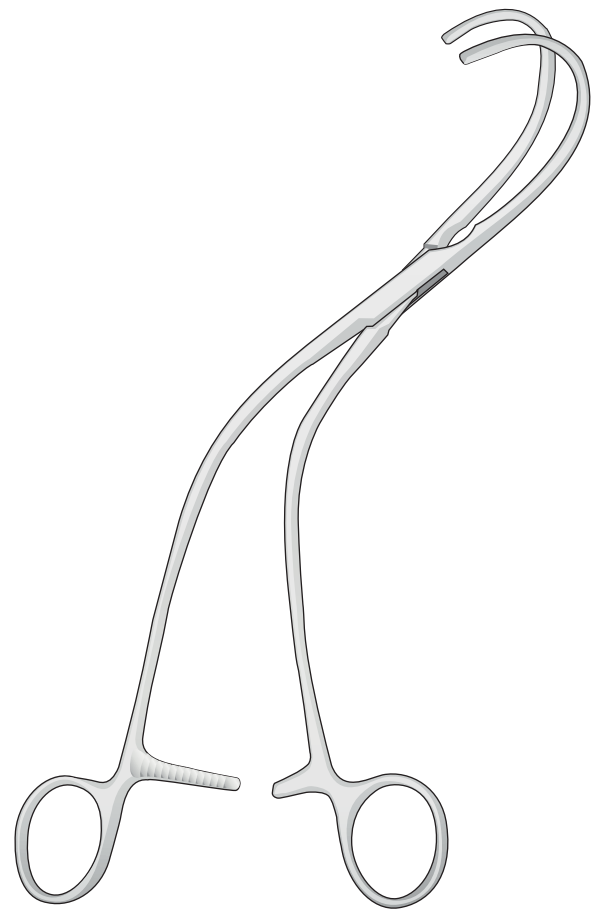


Destra  
Right  
Rechts  
À droite  
A la derecha

1/1



WEBER  
**FB-145**  
260 mm



WEBER  
**FB-146**  
260 mm



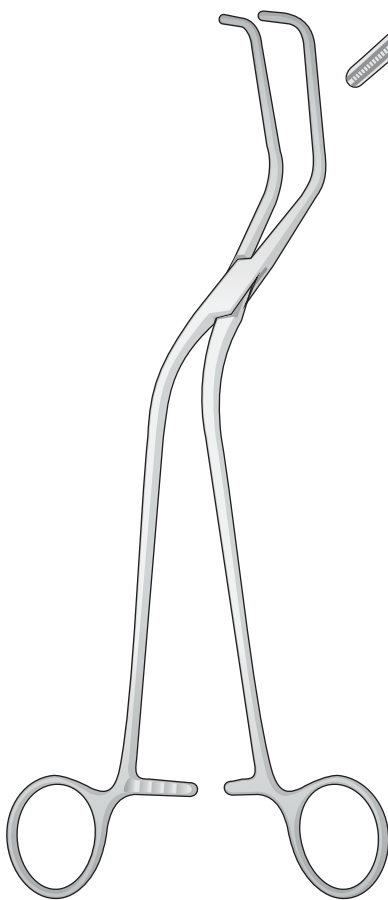
Pinze vascolari  
atraumatiche

Atraumatic  
vessel clamps

Atraumatische  
Gefäßklemmen

Pinces hémostatiques  
atraumatiques

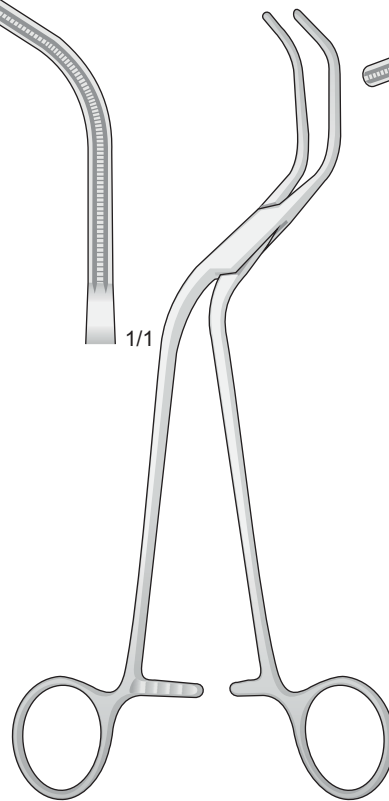
Pinzas vasculares  
atraumáticas



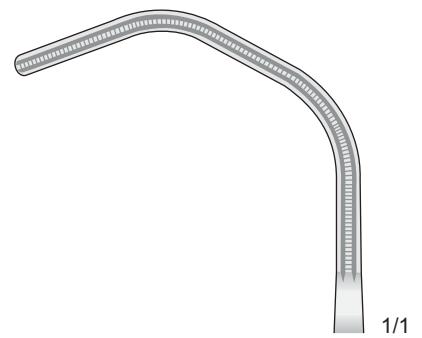
OCHSNER  
**FB-94**  
235 mm



1/1



DIETRICH  
**FB-95**  
210 mm



1/1



Pinze vascolari  
atraumatiche

Atraumatic  
vessel clamps

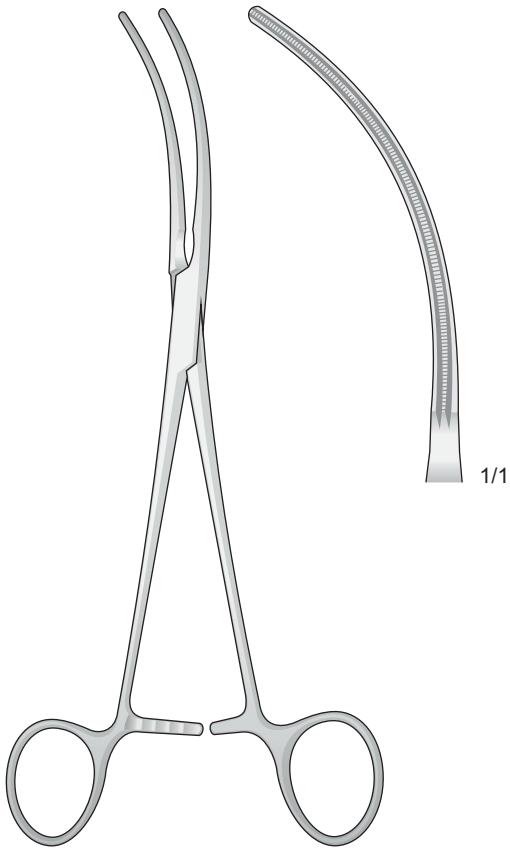
Atraumatische  
Gefäßklemmen

Pinces hémostatiques  
atraumatiques

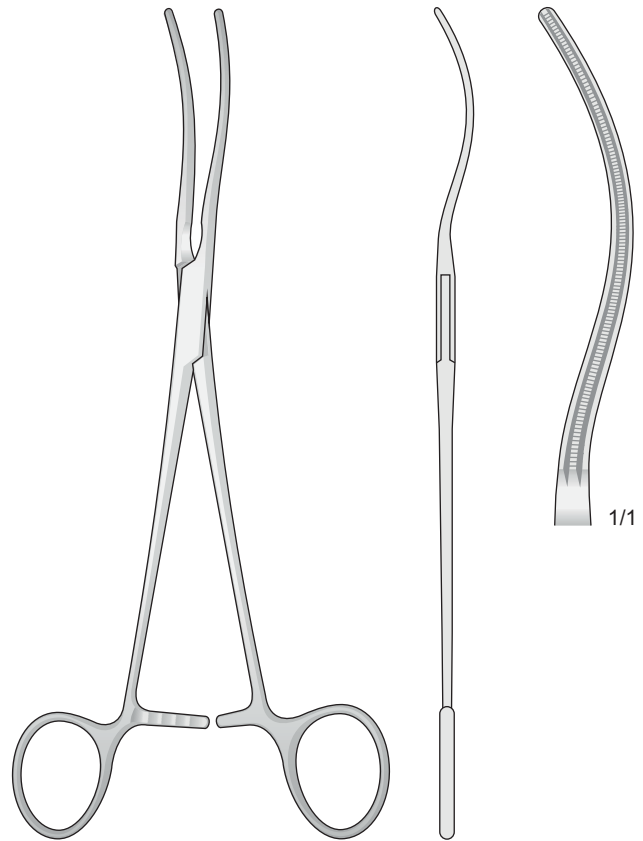
Pinzas vasculares  
atraumáticas



De BAKEY



POTTS  
**FB-131**  
220 mm



POTTS  
**FB-132**  
220 mm





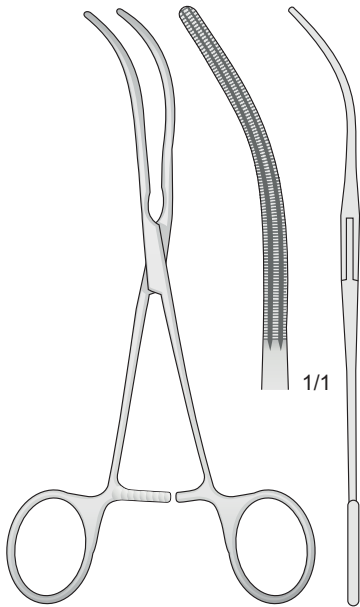
Pinze vascolari  
atraumatiche

Atraumatic  
vessel clamps

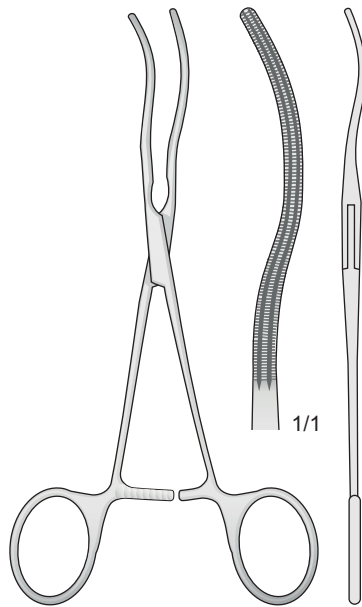
Atraumatische  
Gefäßklemmen

Pinces hémostatiques  
atraumatiques

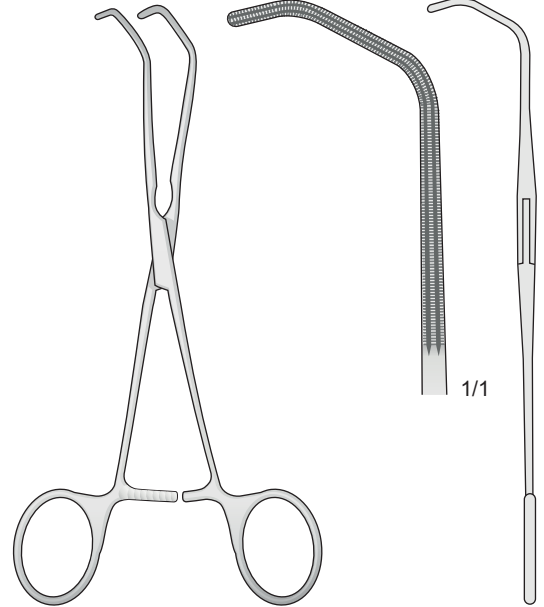
Pinzas vasculares  
atraumáticas



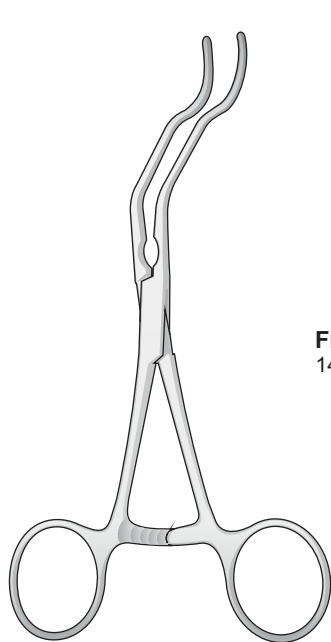
GLOVER  
**FB-184**  
170 mm



**FB-185**  
170 mm



BECK  
**FB-186**  
170 mm



GREGORY  
**FB-110/FB-112**



**FB-110**  
140 mm



**FB-111**  
160 mm



**FB-112**  
180 mm



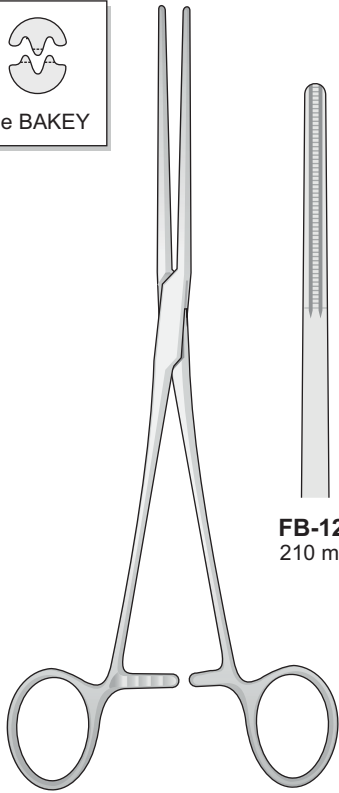
Pinze vascolari  
atraumatiche

Atraumatic  
vessel clamps

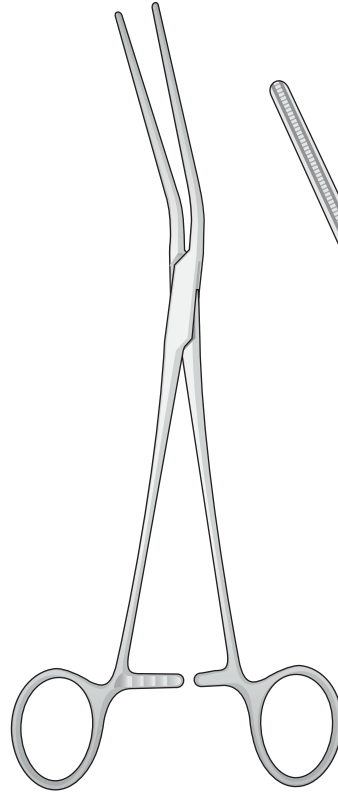
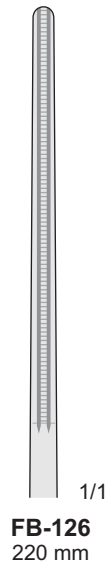
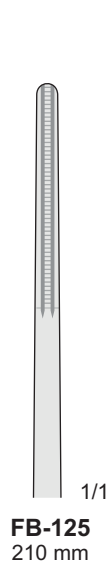
Atraumatische  
Gefäßklemmen

Pinces hémostatiques  
atraumatiques

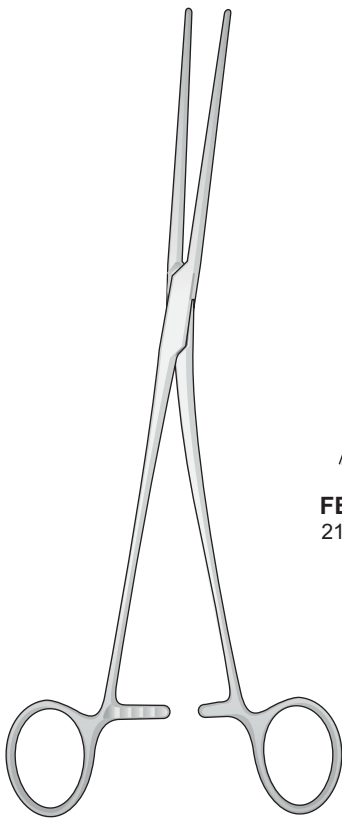
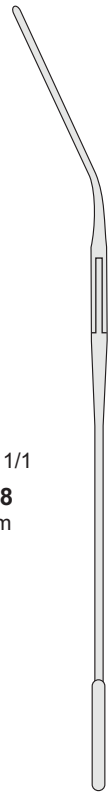
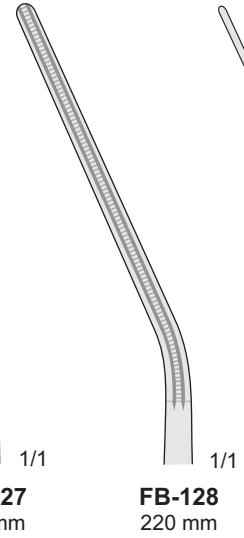
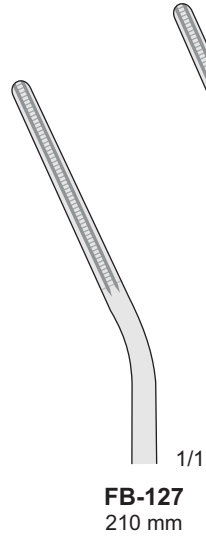
Pinzas vasculares  
atraumáticas



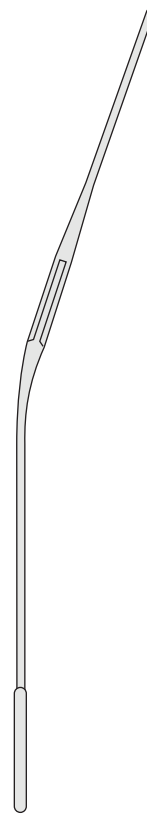
POTTS  
FB-125/FB-126



POTTS  
FB-127/FB-128



POTTS  
FB-129/FB-130





Pinze vascolari  
atraumatiche

Atraumatic  
vessel clamps

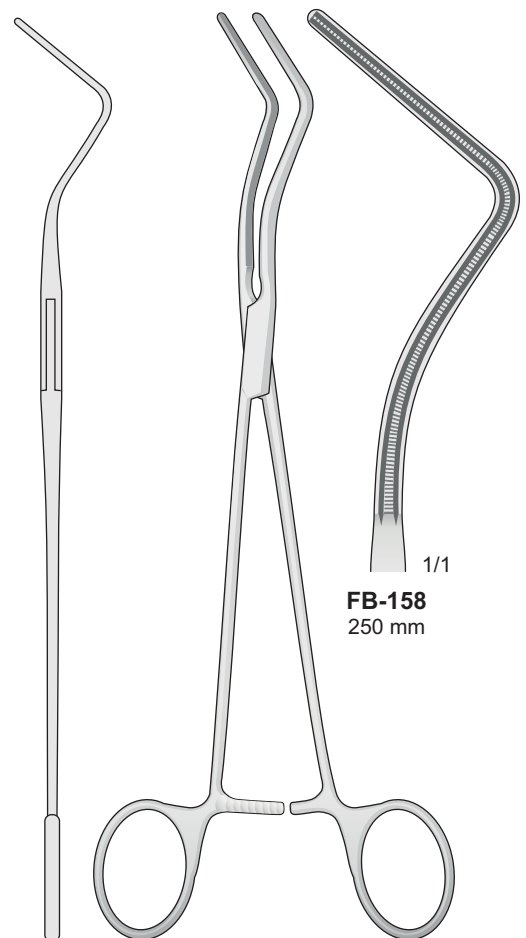
Atraumatische  
Gefäßklemmen

Pinces hémostatiques  
atraumatiques

Pinzas vasculares  
atraumáticas



LEES  
FB-156/FB-157



LEES  
FB-158  
250 mm



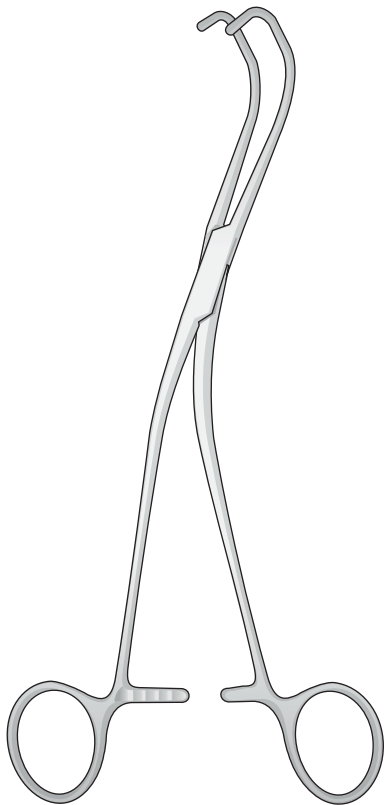
Pinze vascolari  
atraumatiche

Atraumatic  
vessel clamps

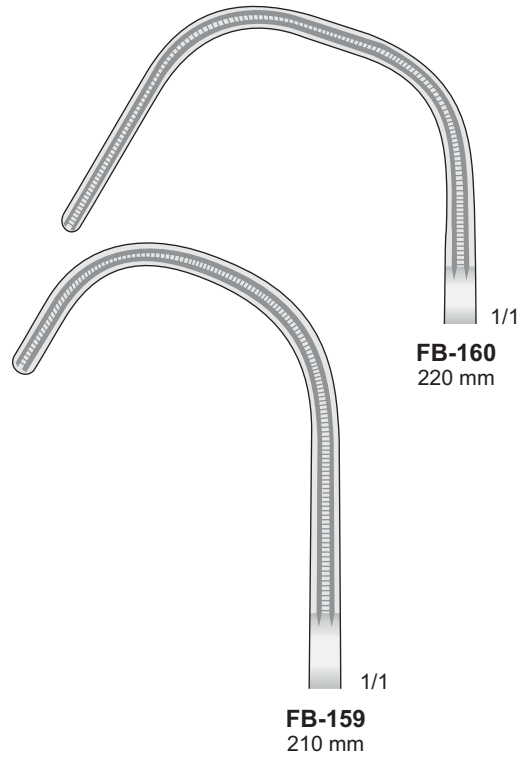
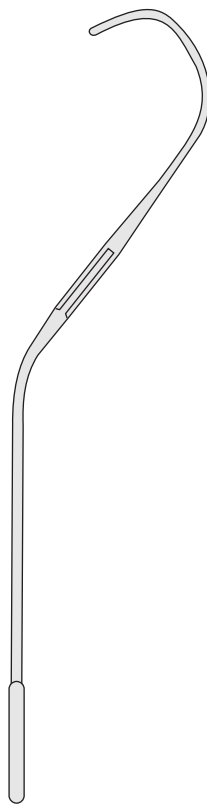
Atraumatische  
Gefäßklemmen

Pinces hémostatiques  
atraumatiques

Pinzas vasculares  
atraumáticas



LAMBERT-KAY  
FB-159/FB-160





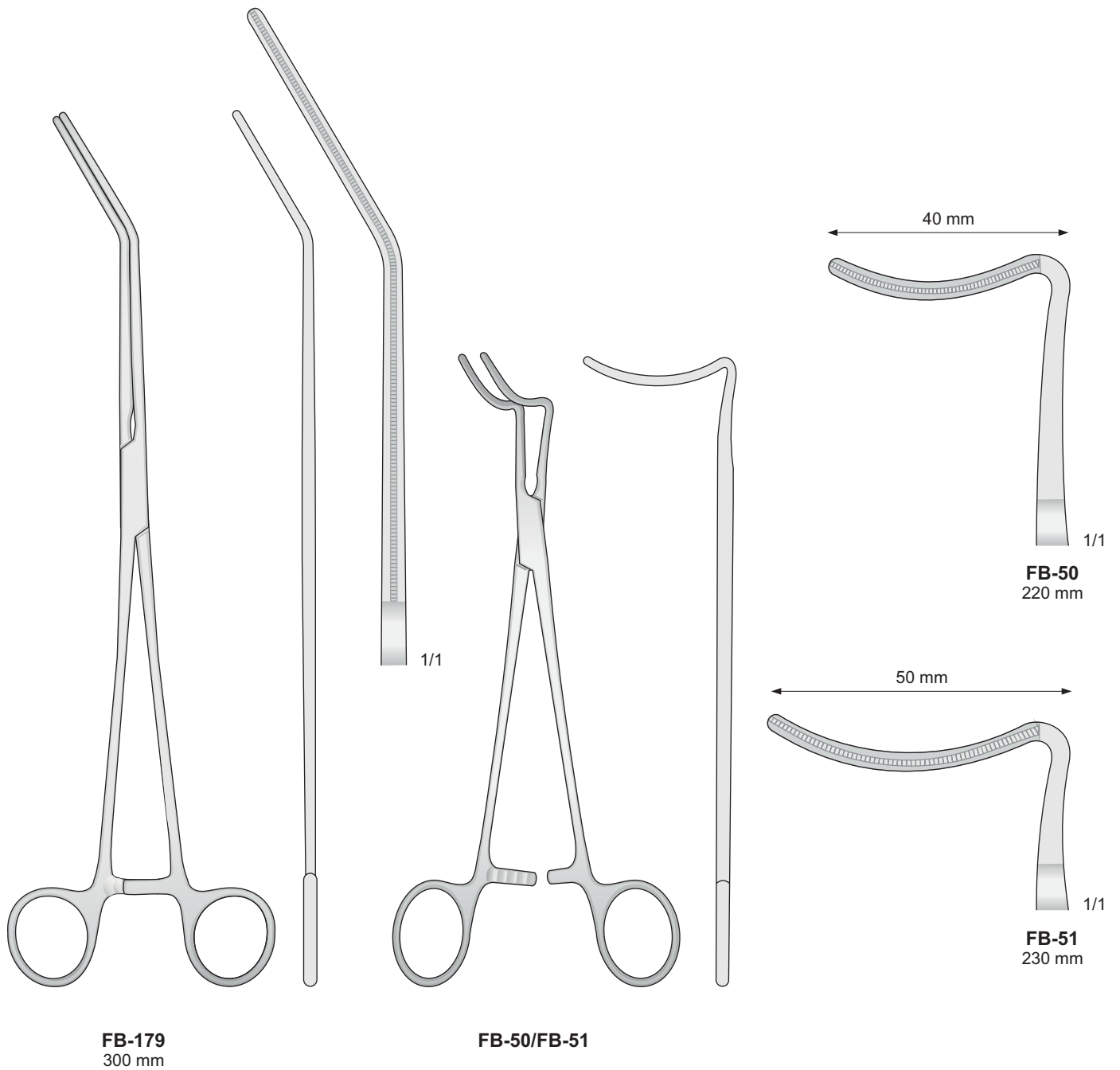
Pinze vascolari  
atraumatiche

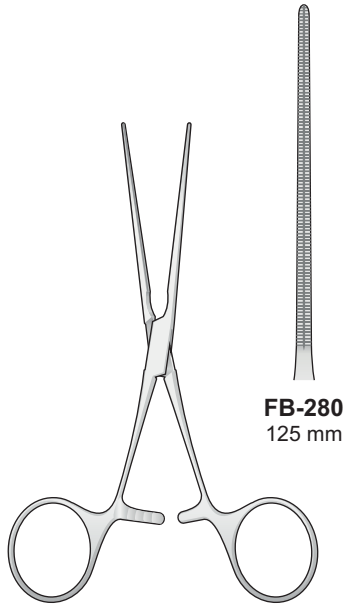
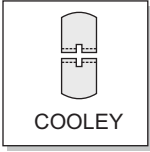
Atraumatic  
vessel clamps

Atraumatische  
Gefäßklemmen

Pinces hémostatiques  
atraumatiques

Pinzas vasculares  
atraumáticas

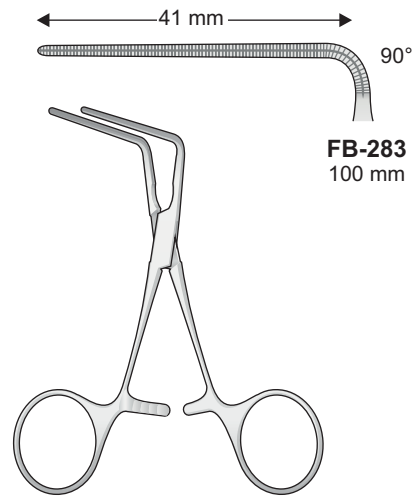




**FB-280**  
125 mm

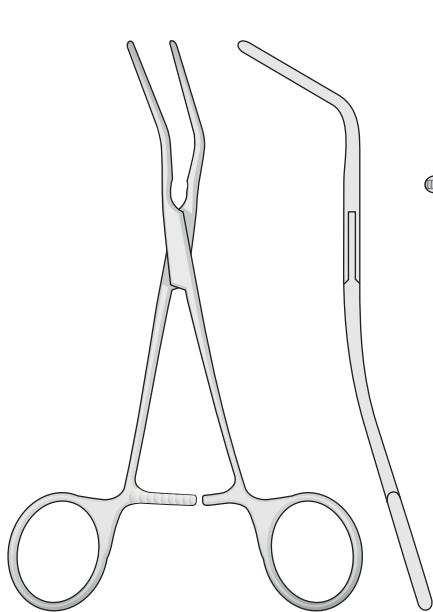
**FB-281**  
115 mm

COOLEY  
**FB-280/FB-281**

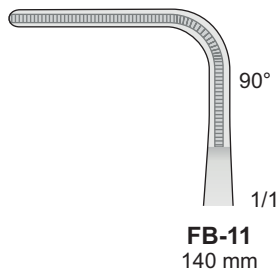


**FB-283**  
100 mm

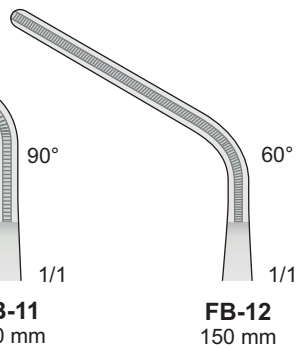
COOLEY  
**FB-283**



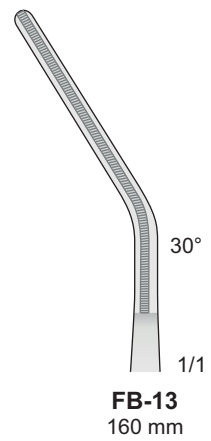
COOLEY  
**FB-11/FB-13**



**FB-11**  
140 mm



**FB-12**  
150 mm



**FB-13**  
160 mm



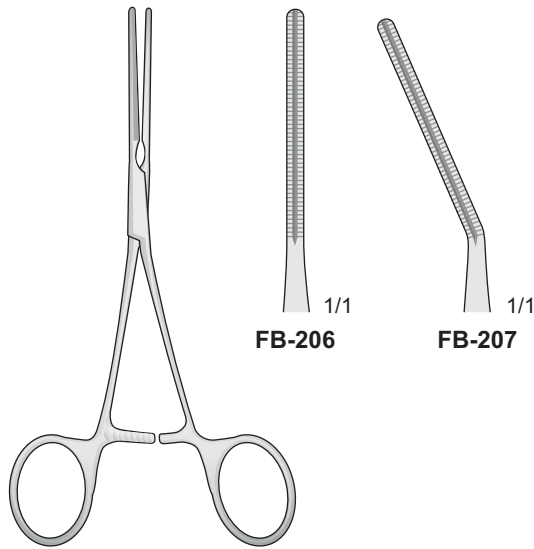
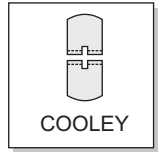
Pinze vascolari  
atraumatiche

Atraumatic  
vessel clamps

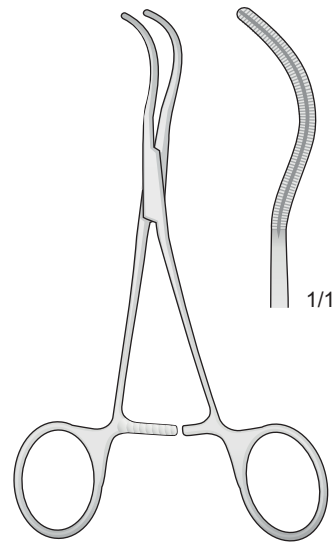
Atraumatische  
Gefäßklemmen

Pinces hémostatiques  
atraumatiques

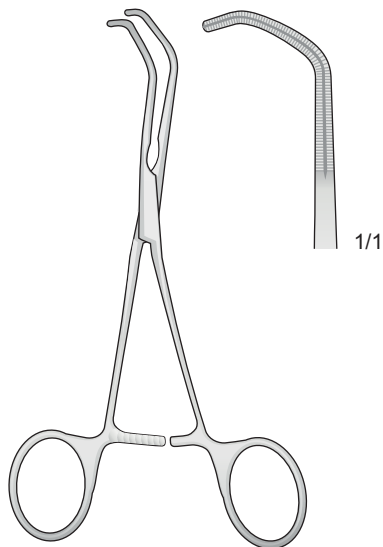
Pinzas vasculares  
atraumáticas



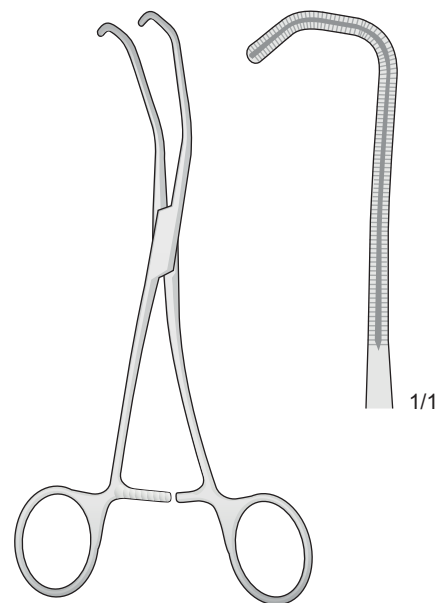
COOLEY  
FB-206/FB-207  
140 mm



COOLEY  
FB-210  
140 mm



COOLEY  
FB-209  
140 mm



COOLEY  
FB-190  
160 mm



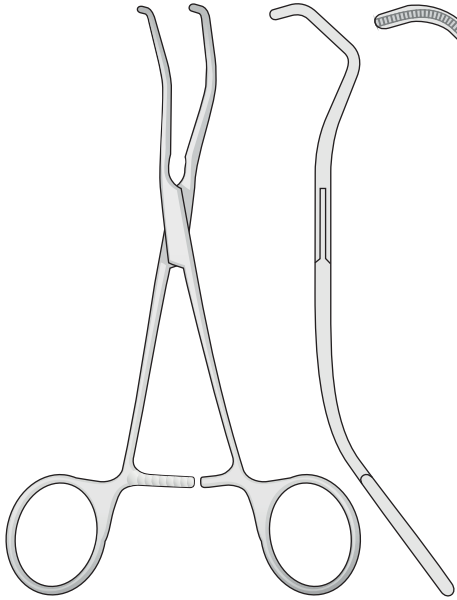
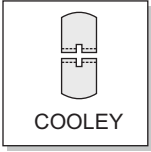
Pinze vascolari  
atraumatiche

Atraumatic  
vessel clamps

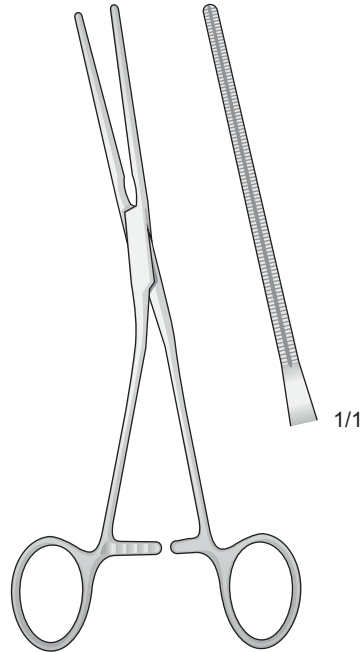
Atraumatische  
Gefäßklemmen

Pinces hémostatiques  
atraumatiques

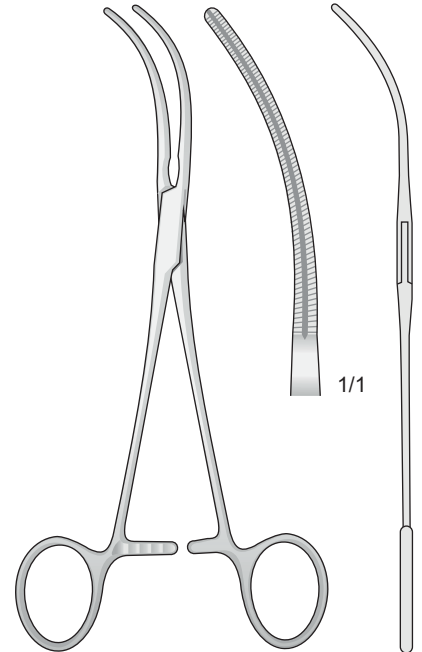
Pinzas vasculares  
atraumáticas



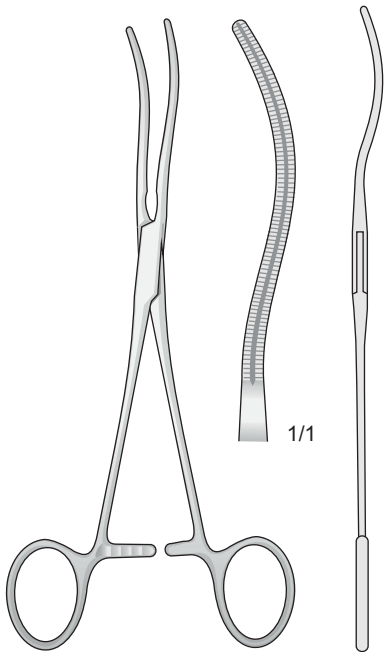
COOLEY  
**FB-16**  
160 mm



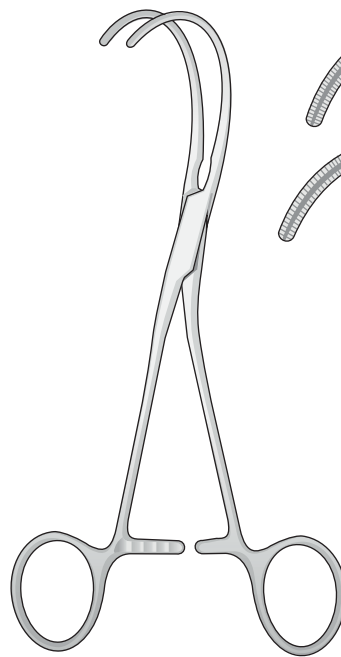
COOLEY  
**FB-195**  
170 mm



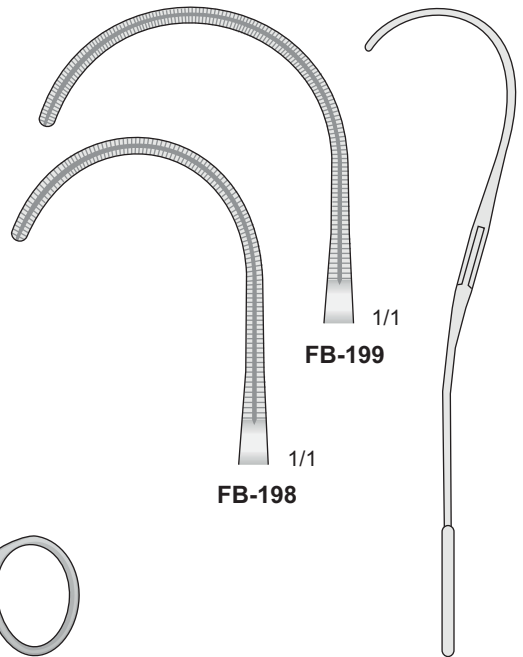
COOLEY  
**FB-196**  
170 mm



COOLEY  
**FB-197**  
170 mm



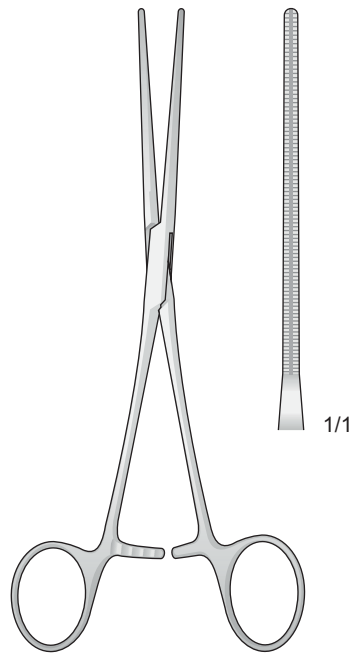
COOLEY  
**FB-198/FB-199**  
170 mm



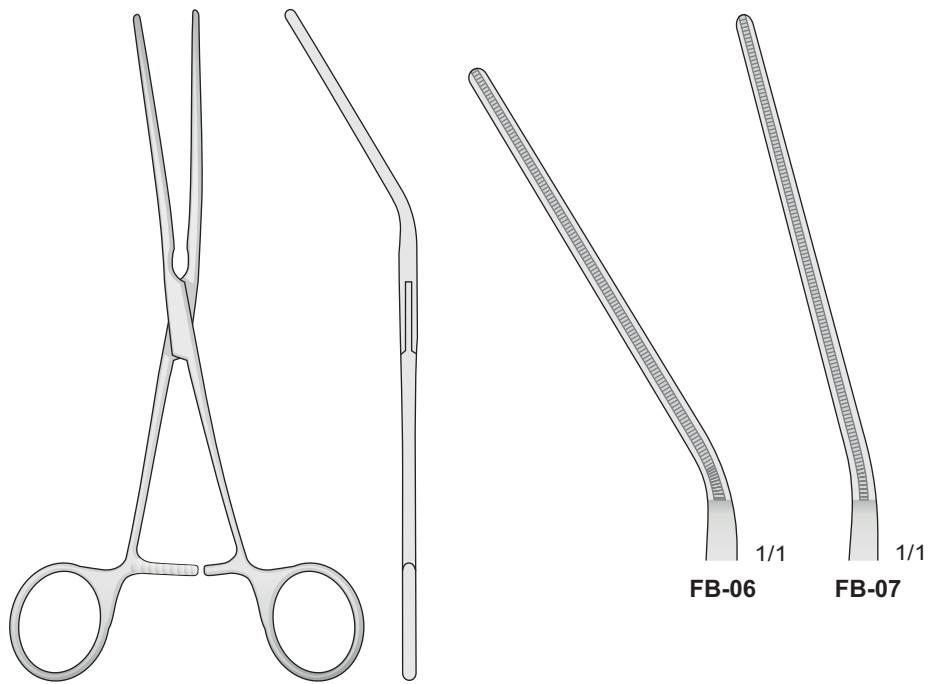
**FB-199**

**FB-198**





COOLEY  
FB-188  
170 mm



LELAND - JONES  
FB-06/FB-07  
190 mm

FB-06

FB-07



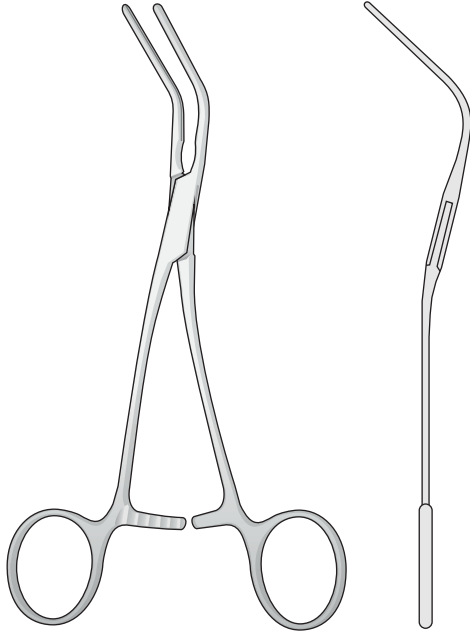
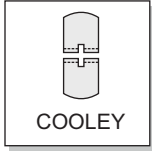
Pinze vascolari  
atraumatiche

Atraumatic  
vessel clamps

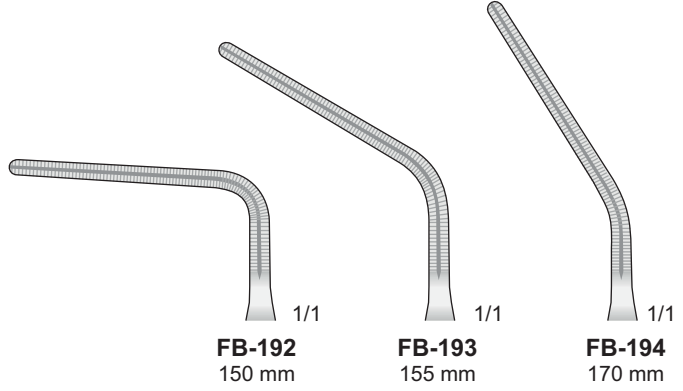
Atraumatische  
Gefäßklemmen

Pinces hémostatiques  
atraumatiques

Pinzas vasculares  
atraumáticas



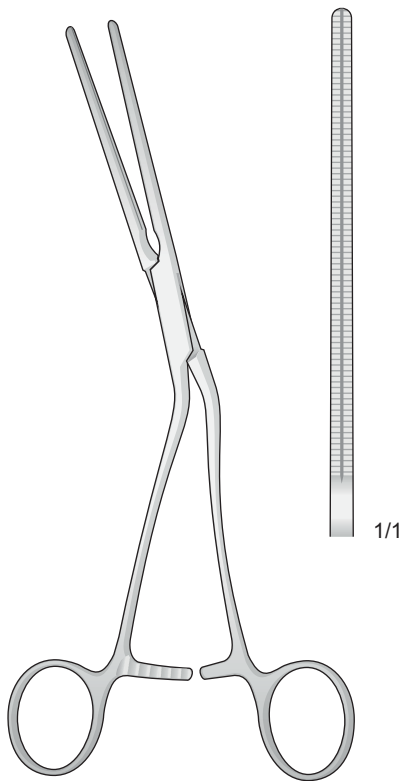
COOLEY  
FB-192/FB-194



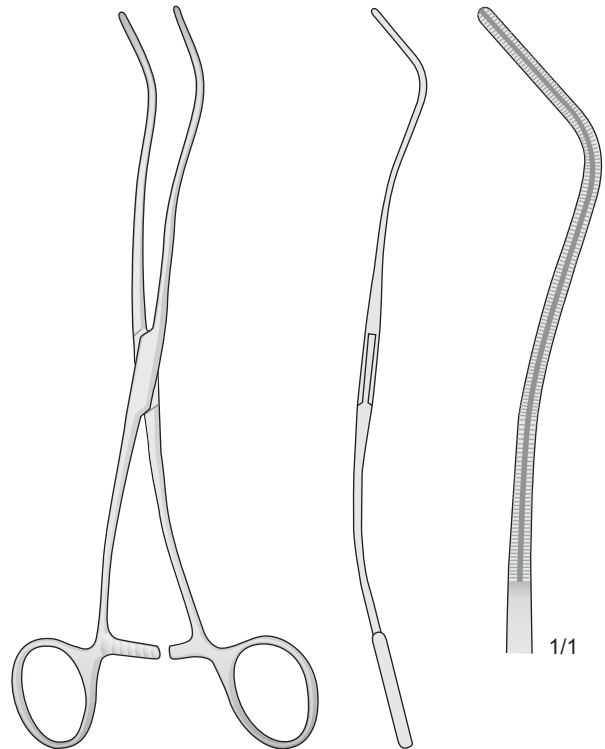
FB-192  
150 mm

FB-193  
155 mm

FB-194  
170 mm



COOLEY  
FB-187  
210 mm



COOLEY  
FB-189  
200 mm



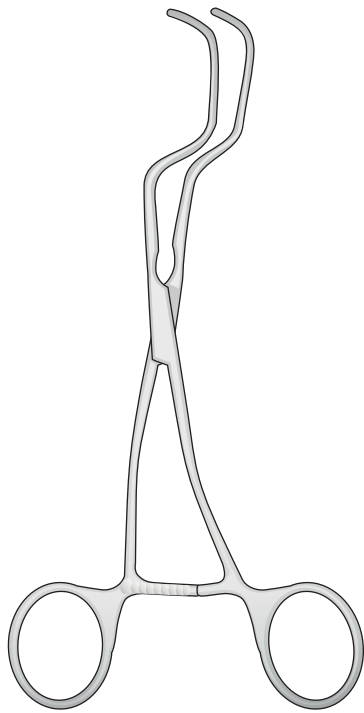
Pinze vascolari  
atraumatiche

Atraumatic  
vessel clamps

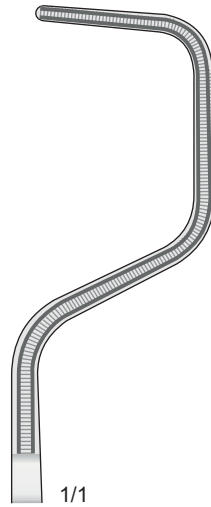
Atraumatische  
Gefäßklemmen

Pinces hémostatiques  
atraumatiques

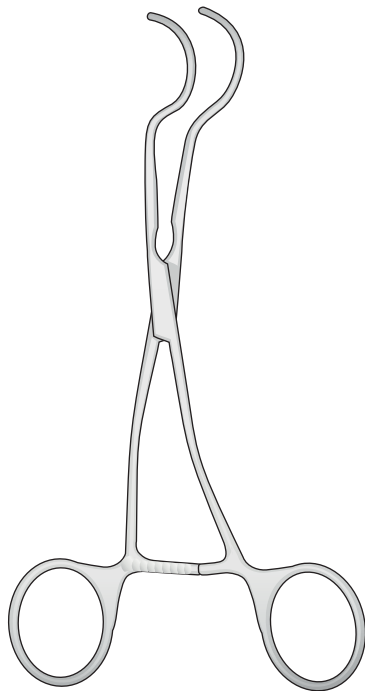
Pinzas vasculares  
atraumáticas



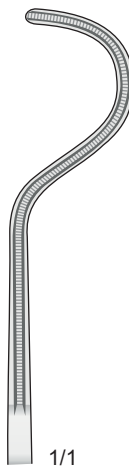
DALE  
**FB-96**  
185 mm



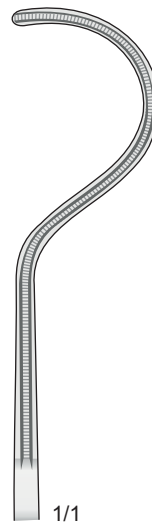
1/1  
**FB-96**  
185 mm



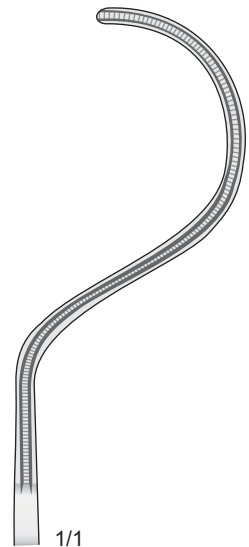
DALE  
**FB-97/FB-99**



1/1  
**FB-97**  
170 mm



1/1  
**FB-98**  
175 mm



1/1  
**FB-99**  
185 mm



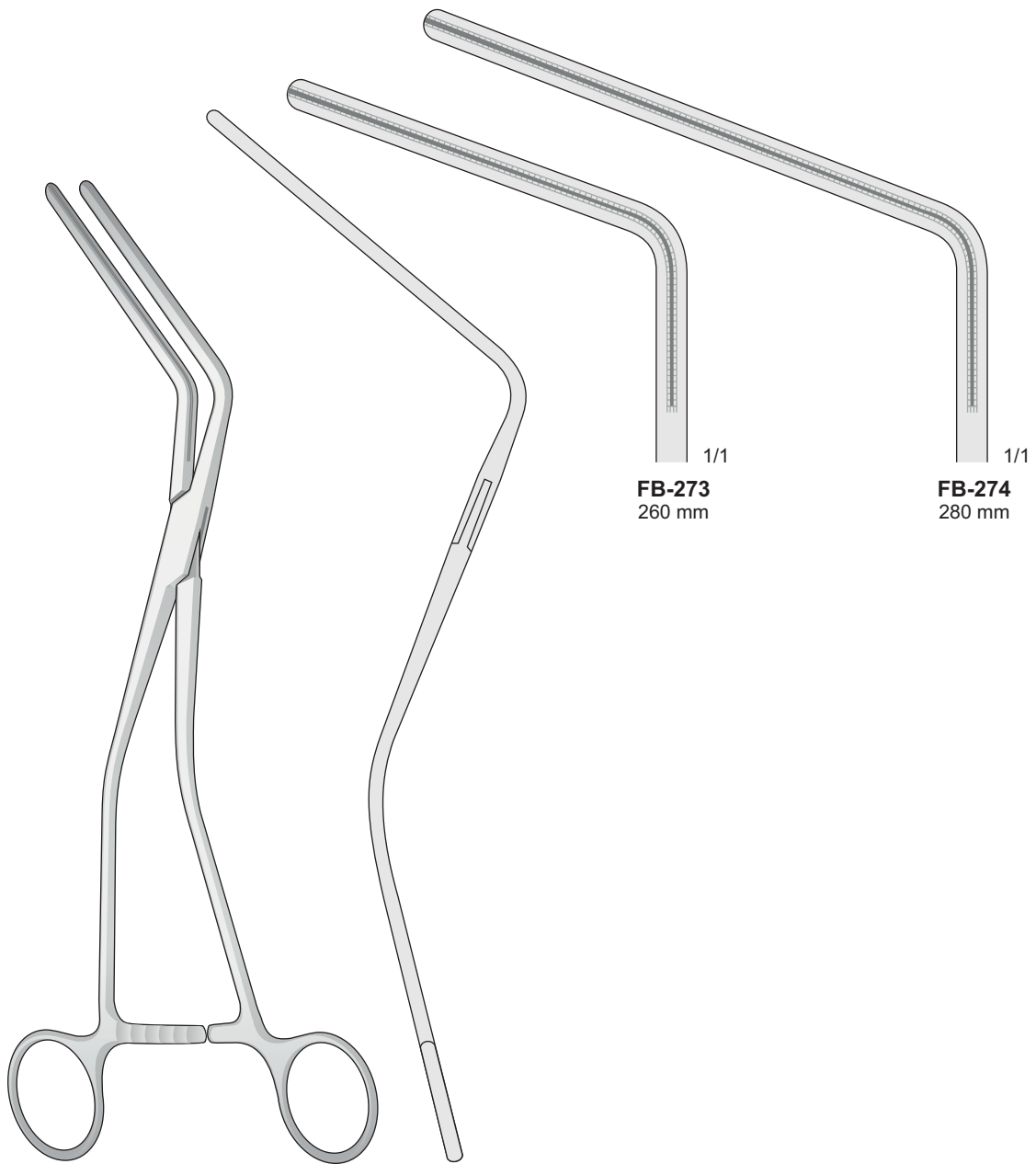
Pinze  
atraumatiche

Atraumatic  
clamps

Atraumatische  
Klemmen

Pinces  
atraumatiques

Pinzas  
atraumáticas



HAYES  
FB-273/FB-274

FB-273  
260 mm

FB-274  
280 mm



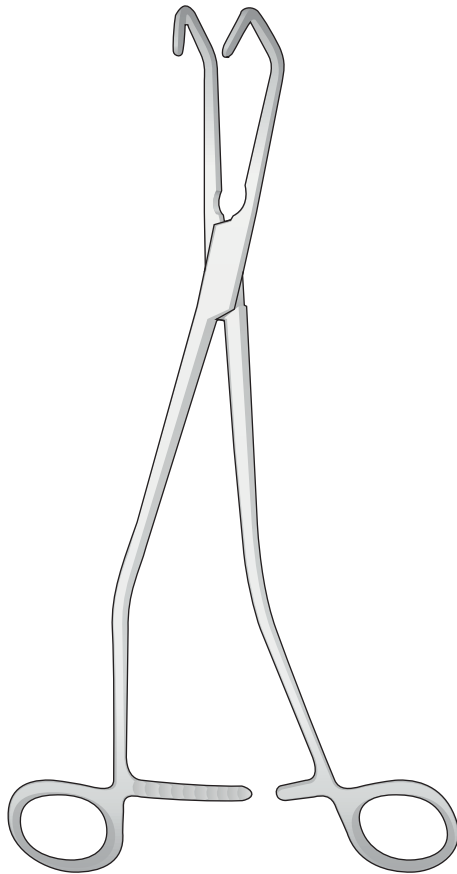
Pinze  
atraumatiche

Atraumatic  
clamps

Atraumatische  
Klemmen

Pinces  
atraumatiques

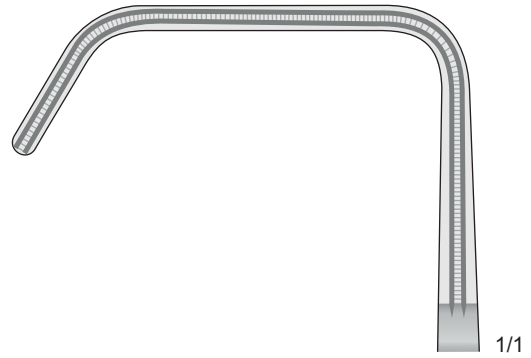
Pinzas  
atraumáticas



HOPT  
FB-268 - 230 mm  
FB-269 - 235 mm  
FB-270 - 240 mm



1/1  
FB-268  
40 mm



1/1  
FB-269  
50 mm



1/1  
FB-270  
60 mm



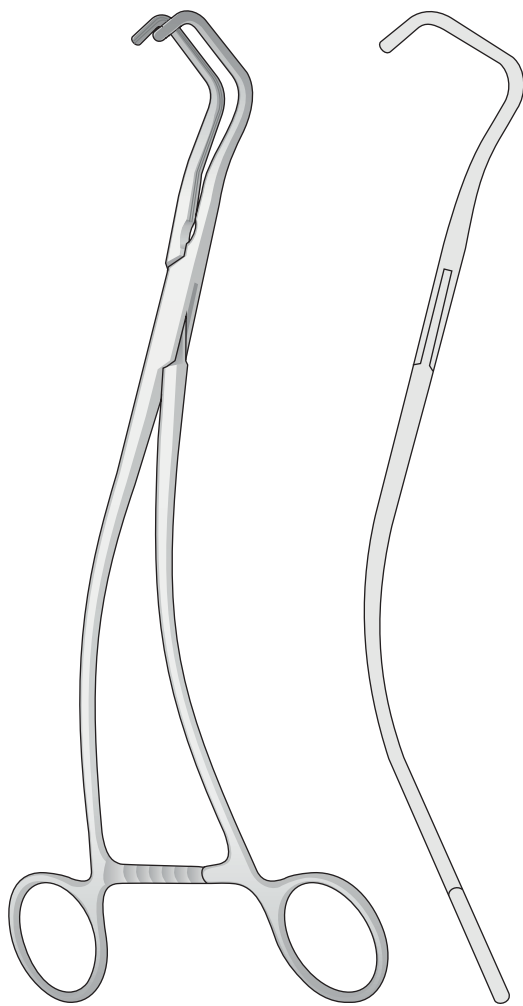
Pinze  
atraumatiche

Atraumatic  
clamps

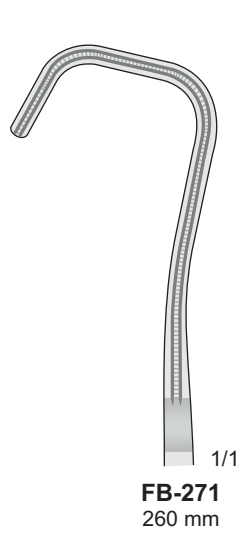
Atraumatische  
Klemmen

Pinces  
atraumatiques

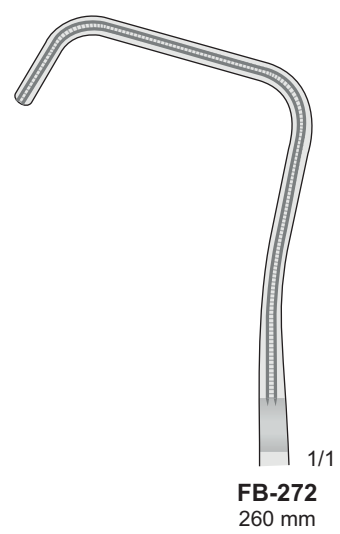
Pinzas  
atraumáticas



URO-TANGENTIAL  
FB-271/FB-272  
260 mm



1/1  
FB-271  
260 mm



1/1  
FB-272  
260 mm



Pinze vascolari  
atraumatiche

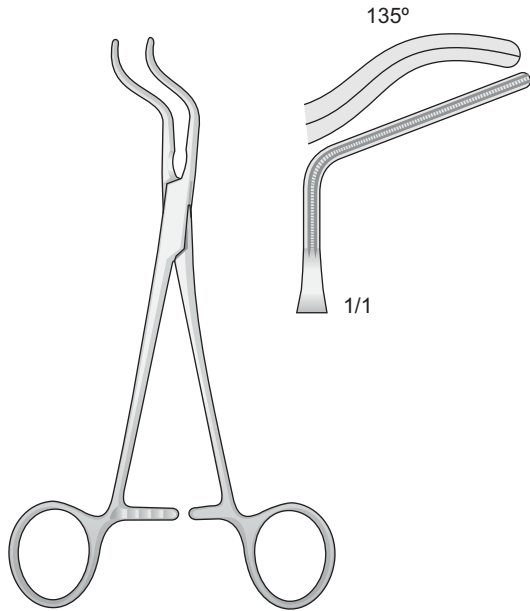
Atraumatic  
vessel clamps

Atraumatische  
Gefäßklemmen

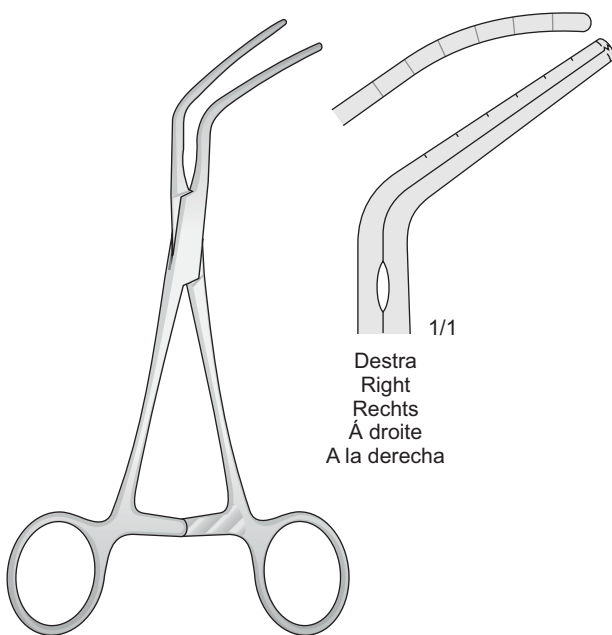
Pinces hémostatiques  
atraumatiques

Pinzas vasculares  
atraumáticas

Per bambini  
For children  
Kinderklemmen  
Pour enfants  
Para niños

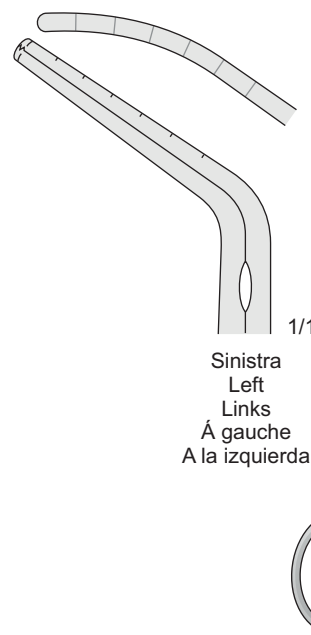


SUBRAMANIAN-MINIATURE  
**FB-176**  
155 mm



SUBRAMANIAN  
**FB-177**  
160 mm

Destra  
Right  
Rechts  
À droite  
A la derecha



Sinistra  
Left  
Links  
À gauche  
A la izquierda

SUBRAMANIAN  
**FB-178**  
160 mm



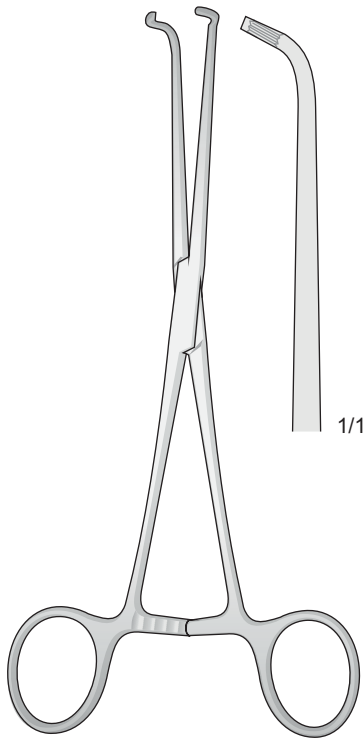
Pinze vascolari  
atraumatiche

Atraumatic  
vessel clamps

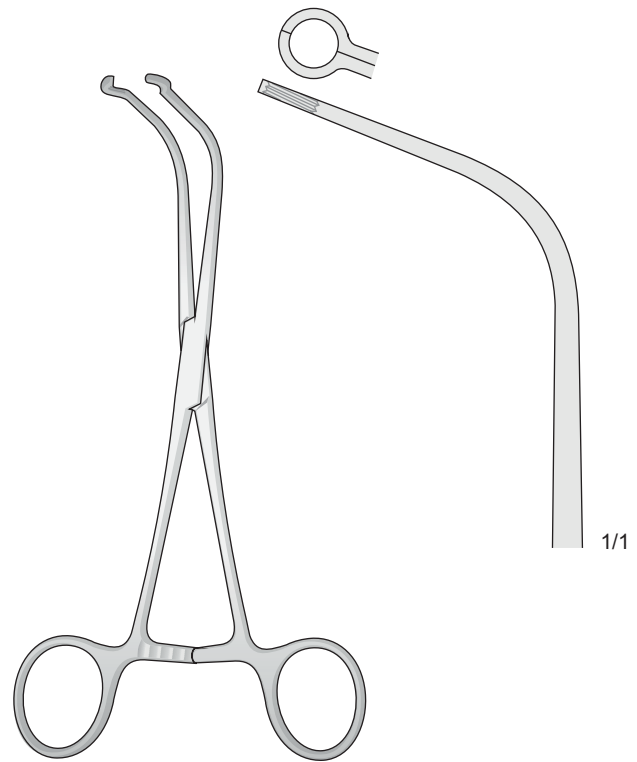
Atraumatische  
Gefäßklemmen

Pinces hémostatiques  
atraumatiques

Pinzas vasculares  
atraumáticas



JAVID  
**FB-113**  
180 mm

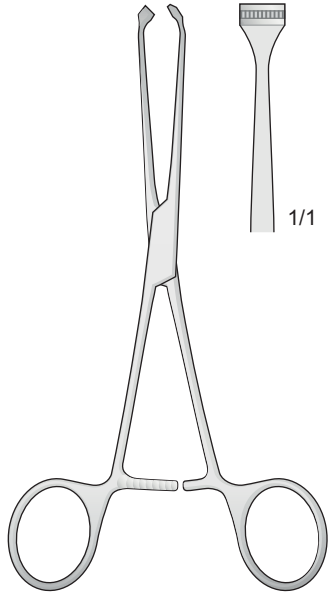


JAVID  
**FB-114**  
190 mm

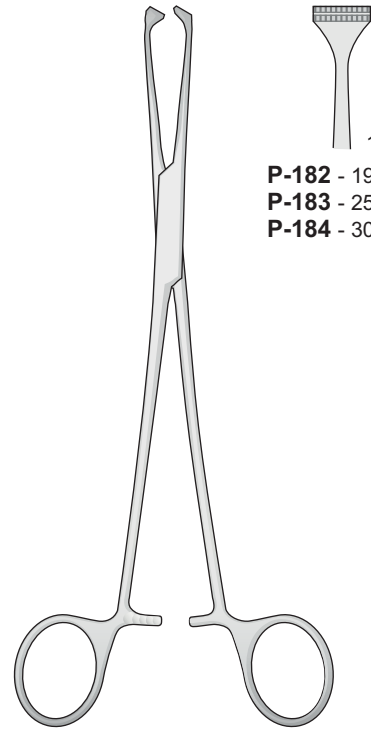




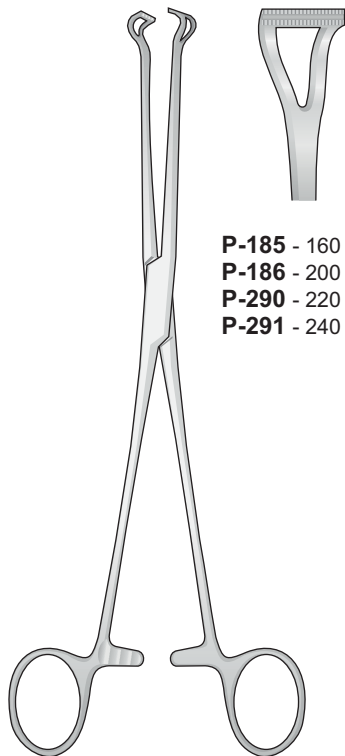
Atraumatiche - Atraumatic - Atraumatiche  
Atraumatique - Atraumáticas



ALLIS  
**P-52**  
150 mm

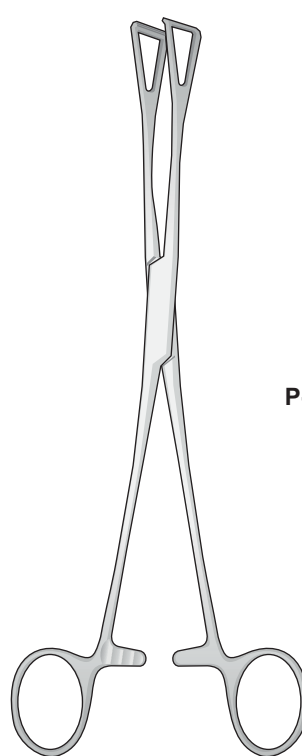


1/1  
**P-182** - 190 mm  
**P-183** - 250 mm  
**P-184** - 300 mm



BABCOCK  
**P-185/P-291**

**P-185** - 160 mm  
**P-186** - 200 mm  
**P-290** - 220 mm  
**P-291** - 240 mm



DUVAL  
**P-187/P-188**

14 mm  
**P-187** - 200 mm

18 mm  
**P-188** - 200 mm



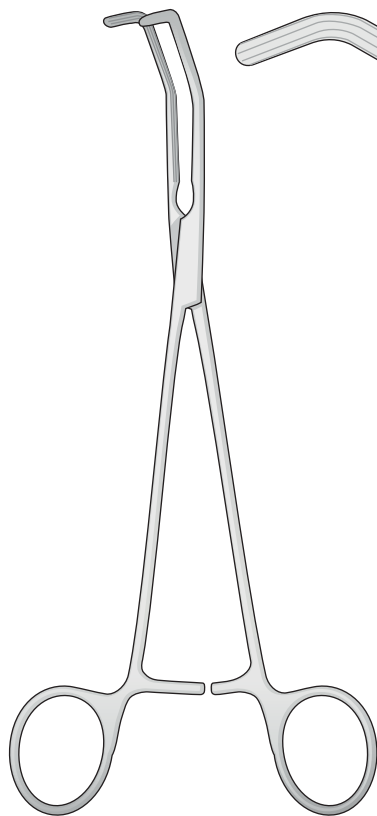
Pinze vascolari  
atraumatiche

Atraumatic  
vessel clamps

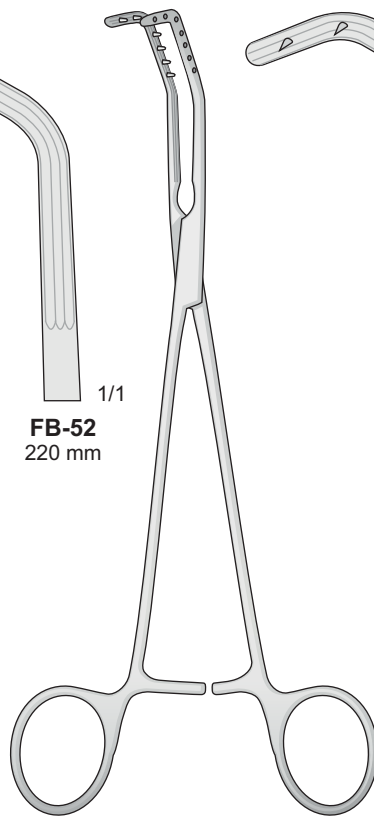
Atraumatische  
Gefäßklemmen

Pinces hémostatiques  
atraumatiques

Pinzas vasculares  
atraumáticas



PRICE - THOMAS  
**FB-52**  
220 mm

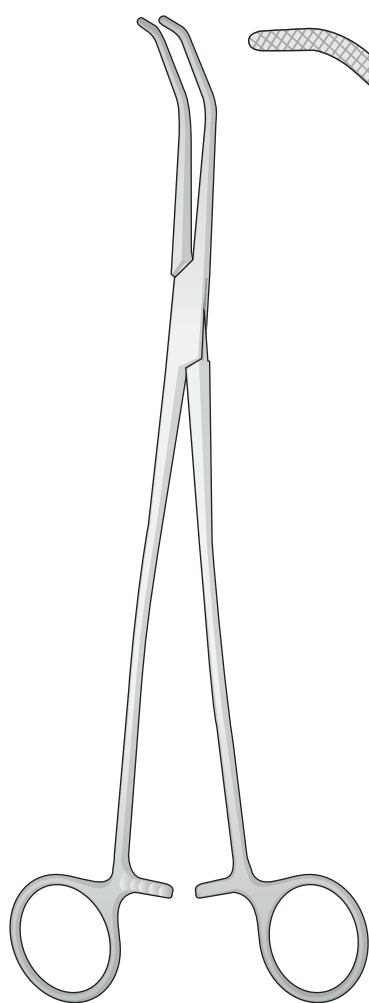


PRICE - THOMAS  
**FB-53/FB-54**

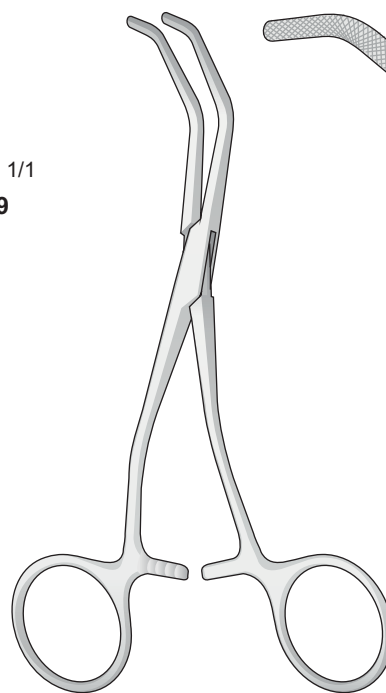
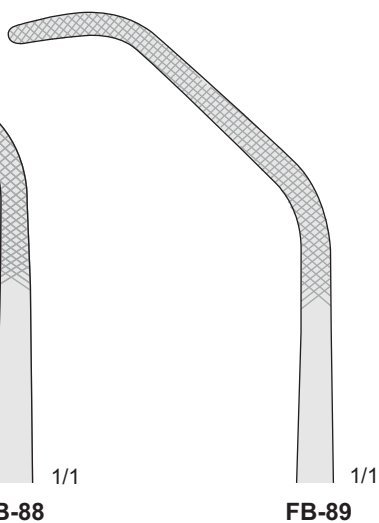
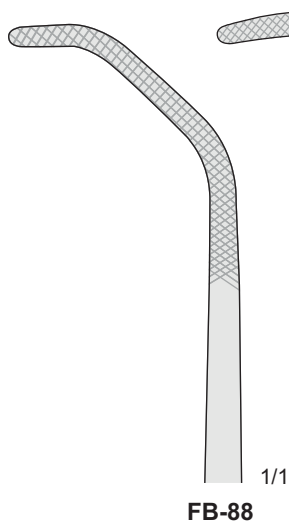
**FB-52**  
220 mm

**FB-53**  
220 mm

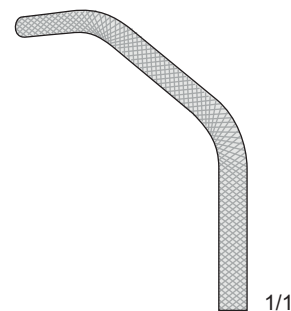
**FB-54**  
220 mm



**SATINSKY**  
**FB-88/FB-89**  
260 mm



**BABY-SATINSKY**  
**FB-46**  
150 mm





DE BAKEY  
FB-301/FB-312  
190 mm



**FB-301**  
Ø 0,5 mm



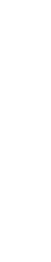
**FB-302**  
Ø 1,0 mm



**FB-303**  
Ø 1,5 mm



**FB-304**  
Ø 2,0 mm



**FB-305**  
Ø 2,5 mm



**FB-306**  
Ø 3,0 mm



**FB-307**  
Ø 3,5 mm



**FB-308**  
Ø 4,0 mm



**FB-309**  
Ø 4,5 mm



**FB-310**  
Ø 5,0 mm



**FB-311**  
Ø 7,0 mm



**FB-312**  
Ø 9,0 mm

**FB-300**  
Set completo di 12 pezzi  
Set complete with 12 pieces  
Komplettset mit 12 Stück  
Set complet avec 12 pièces  
Set completo con 12 piezas



**FB-351** - 140 mm - Ø 1,0  
**FB-352** - 140 mm - Ø 1,5  
**FB-353** - 140 mm - Ø 2,0  
**FB-354** - 140 mm - Ø 2,5  
**FB-355** - 140 mm - Ø 3,0  
**FB-356** - 140 mm - Ø 3,5  
**FB-357** - 140 mm - Ø 4,0  
**FB-358** - 140 mm - Ø 4,5  
**FB-359** - 140 mm - Ø 5,0

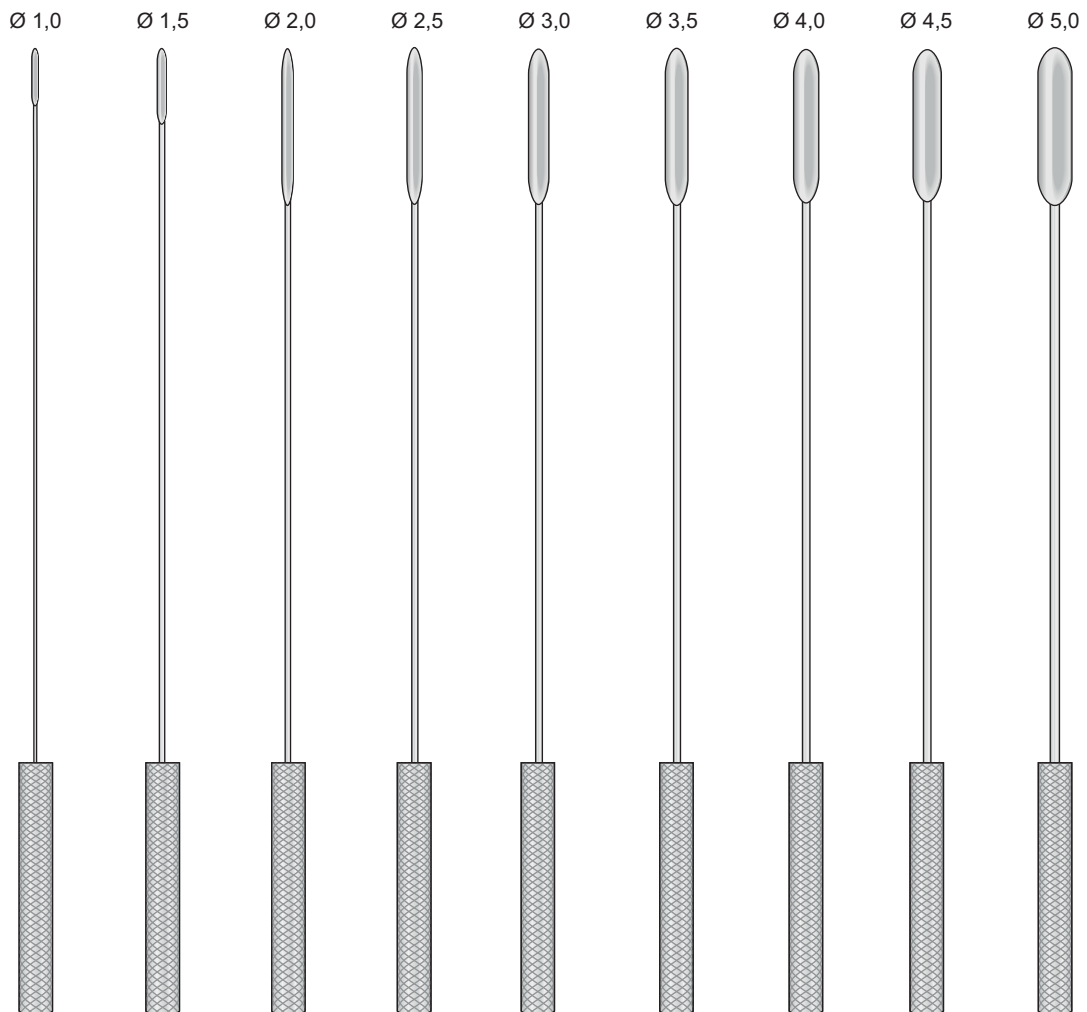
**FB-361** - 210 mm - Ø 1,0  
**FB-362** - 210 mm - Ø 1,5  
**FB-363** - 210 mm - Ø 2,0  
**FB-364** - 210 mm - Ø 2,5  
**FB-365** - 210 mm - Ø 3,0  
**FB-366** - 210 mm - Ø 3,5  
**FB-367** - 210 mm - Ø 4,0  
**FB-368** - 210 mm - Ø 4,5  
**FB-369** - 210 mm - Ø 5,0

**FB-350**

Set completo di 9 pezzi  
Set complete with 9 pieces  
Komplettset mit 9 Stück  
Saet complet avec 9 pièces  
Set completo con 9 piezas

**FB-360**

Set completo di 9 pezzi  
Set complete with 9 pieces  
Komplettset mit 9 Stück  
Saet complet avec 9 pièces  
Set completo con 9 piezas



GARRETT  
FB-351/FB-369



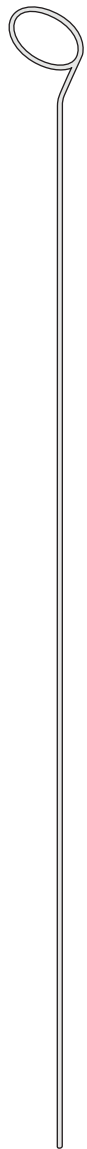
Stripper anello tira vene

Vein stripper

Ringstripper

Stripper à anneau

Sonda para vârices



Ø 2 mm  
○ 1/1  
**FB-381**

Ø 3 mm  
○ 1/1  
**FB-382**

Ø 4 mm  
○ 1/1  
**FB-383**

Ø 6 mm  
○ 1/1  
**FB-384**

Ø 7 mm  
○ 1/1  
**FB-385**

Ø 8,5 mm  
○ 1/1  
**FB-386**

Ø 10 mm  
○ 1/1  
**FB-387**

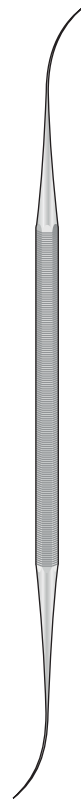
Ø 12 mm  
○ 1/1  
**FB-388**

Ø 14 mm  
○ 1/1  
**FB-389**

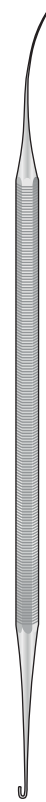
VOLLMAR  
**FB-381/FB-389**  
500 mm



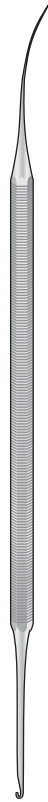
**FB-380**  
120 mm



VARADY  
**FB-107**  
180 mm



VARADY  
**FB-108**  
180 mm



VARADY  
**FB-109**  
180 mm

Aghi vascolari malleabili - Gefäßspülkanülen  
Ø 3 mm    Ø 4 mm    Ø 5 mm    Ø 6 mm



SCHMID  
**OL-30**  
150 mm



SCHMID  
**OL-31**  
150 mm



SCHMID  
**OL-32**  
150 mm



SCHMID  
**OL-33**  
150 mm



Dilatatori per  
valvola mitralica

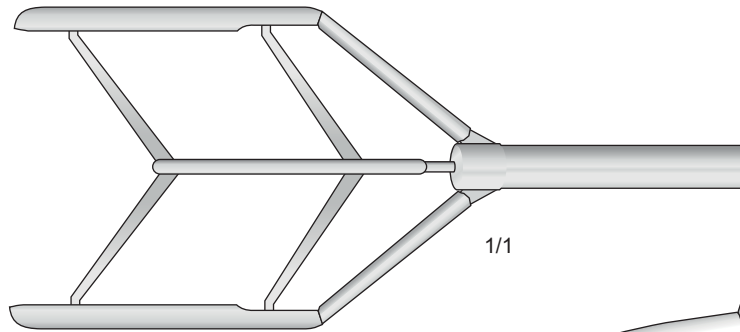
Dilator for  
mitral valve

Dilatator für  
mitralstenosen

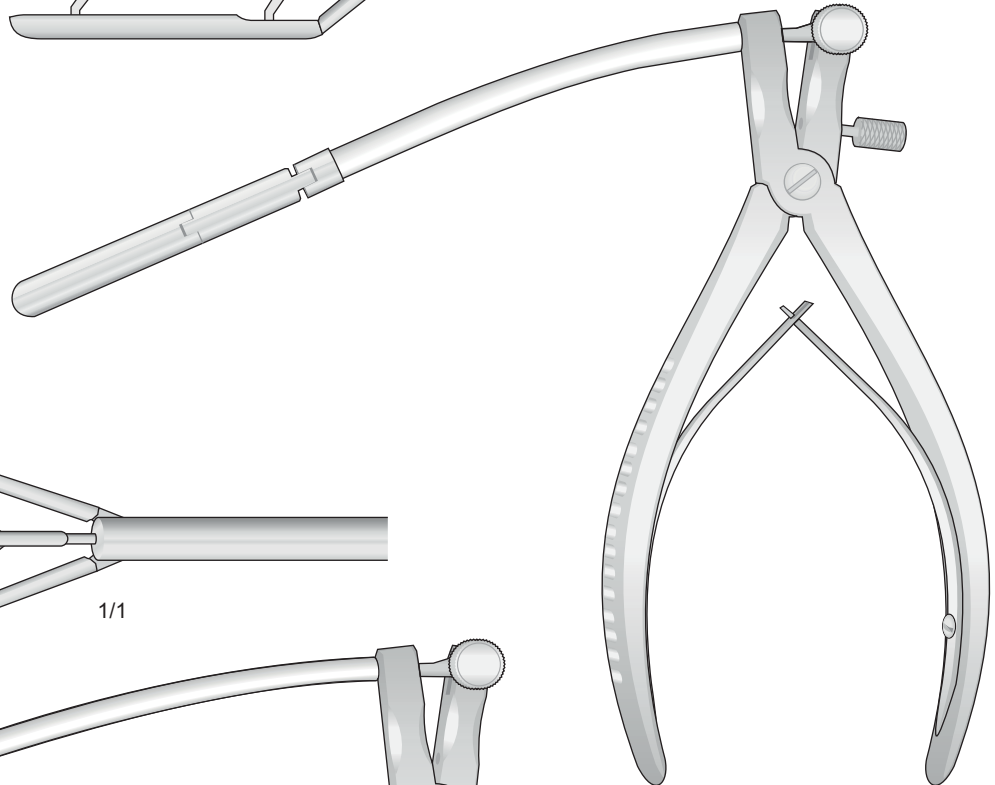
Dilatateurs

Dilatadores para  
valvula mitral

AP. 9-45 mm

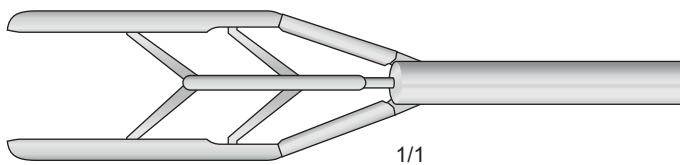


1/1

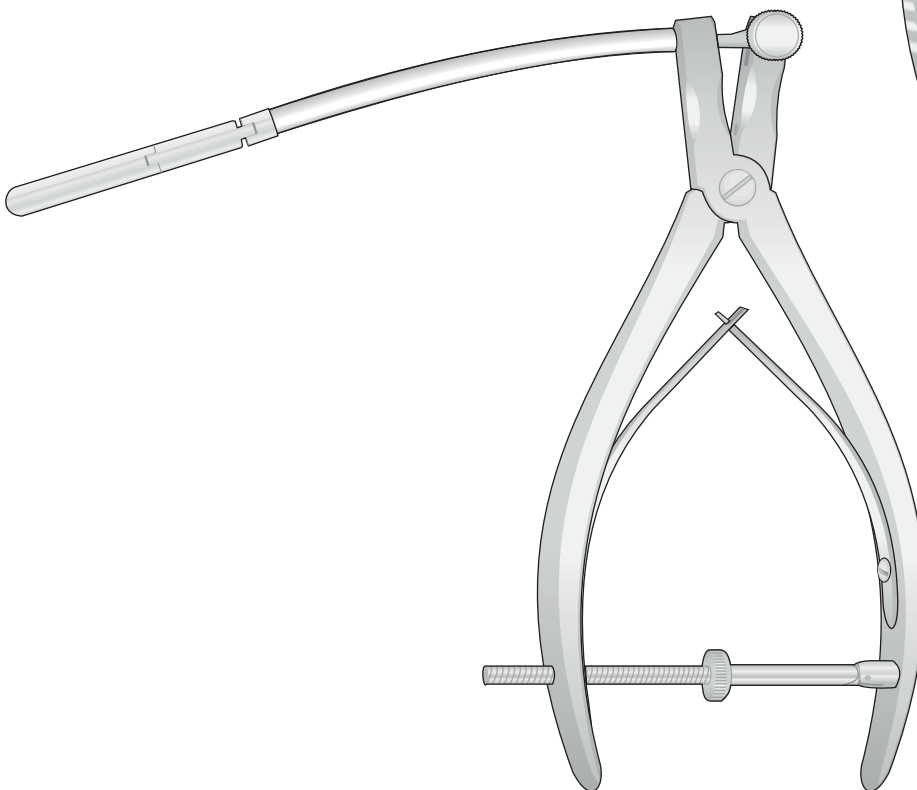


TUBBS  
FB-103

AP. 8-15 mm



1/1



COOLEY  
FB-101



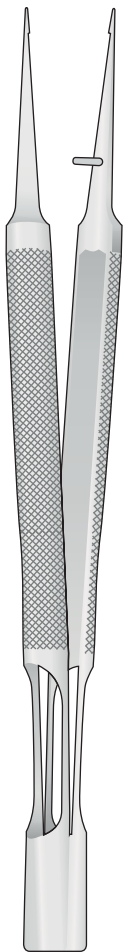
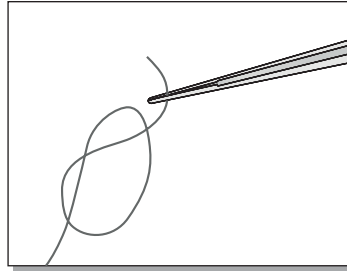




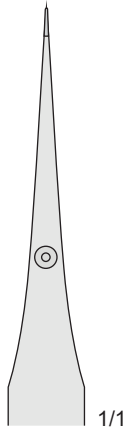
7

Port'aghi, Aghi per legature  
Needle holders, Ligature needles  
Nadelhalter, Unterbindungsnadeln  
Porte aiguilles, Aiguilles à ligatures  
Portaagujas, Agujas para ligaduras

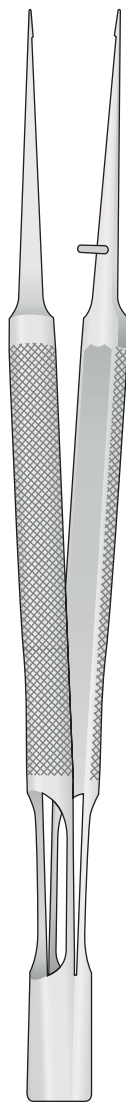




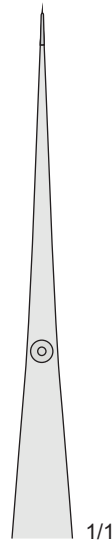
**BROCK  
FD-203**  
130 mm



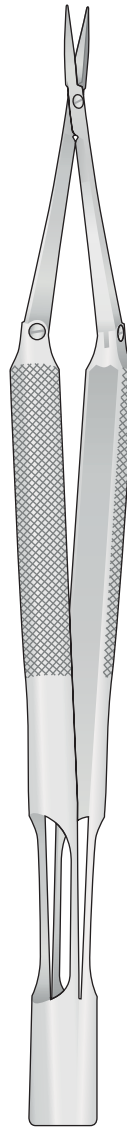
1/1



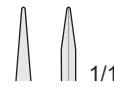
**BROCK  
FD-204**  
150 mm



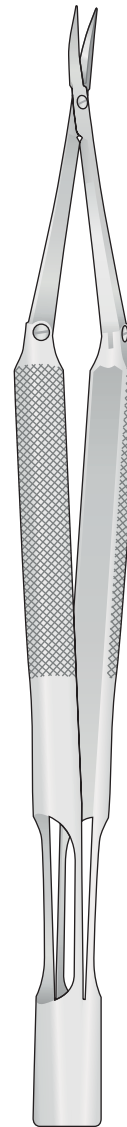
1/1



**BROCK  
FD-211**  
150 mm



1/1



**BROCK  
FD-213**  
150 mm



1/1



Micro port'aghi

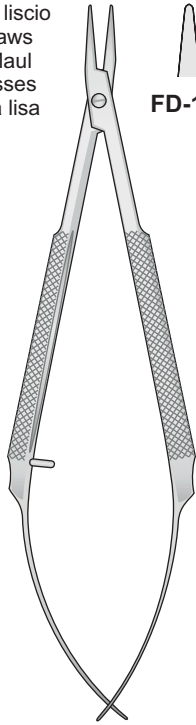
Micro Needle Holders

Micro Nadelhalter

Micro porte aiguilles

Micro portaagujas

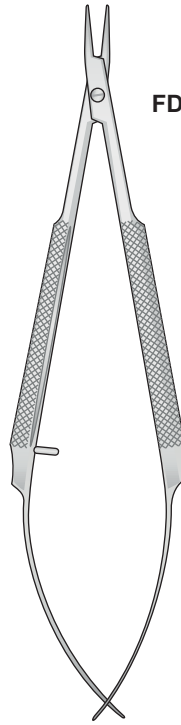
Con morso liscio  
Smooth jaws  
Glattes Maul  
A' mors lisses  
Mandibula lisa



FD-105



FD-106



FD-107

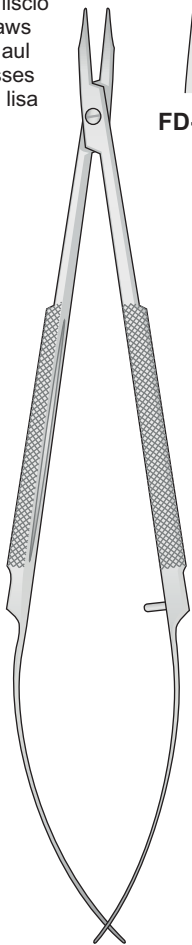


FD-108

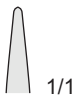
FD-105/FD-106  
110 mm

FD-107/FD-108  
110 mm

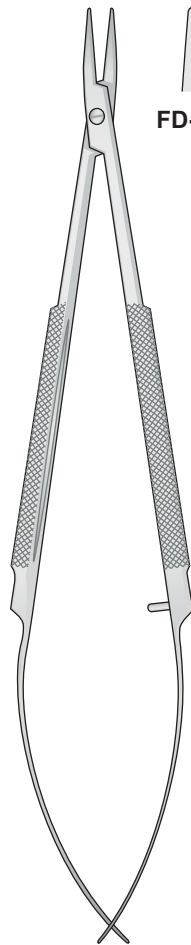
Con morso liscio  
Smooth jaws  
Glattes Maul  
A' mors lisses  
Mandibula lisa



FD-113



FD-114

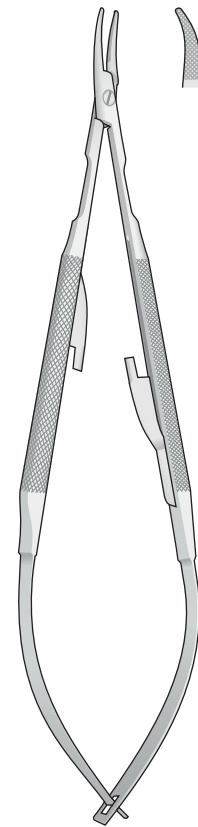


FD-115



FD-116

Con morso zigrinato fine  
Fine serrated jaws  
Feingerieftes Maul  
Mors stries fins  
Bocas estriadas finas

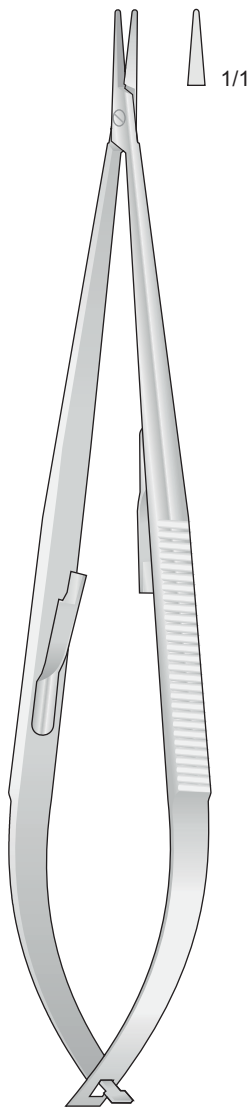


BARRAQUER  
FD-24  
135 mm

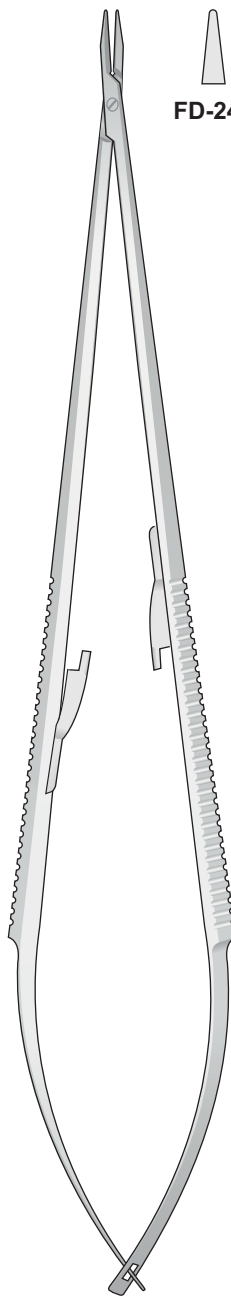




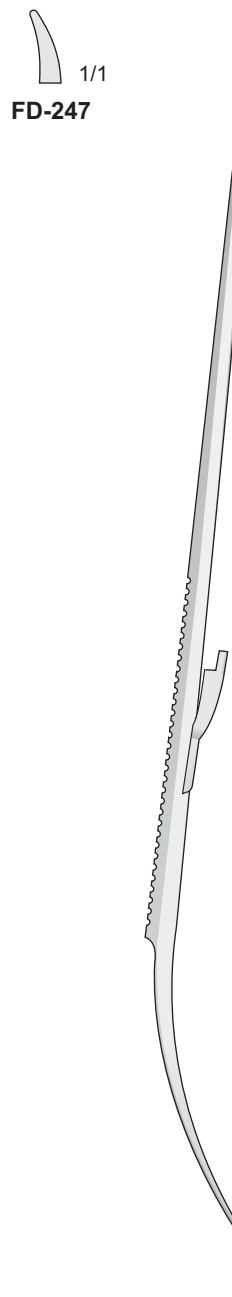
Con morso liscio - Smooth jaws  
Glattes Maul - A' mors lisses - Mandibula lisa



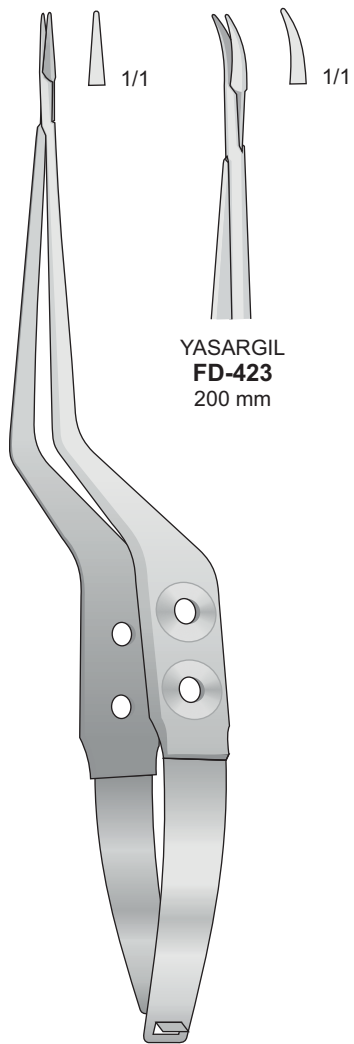
JACOBSON  
FD-63  
180 mm



FD-246/FD-247  
225 mm

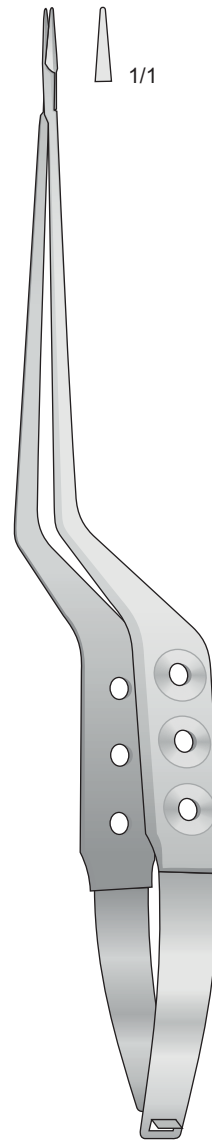


FD-248/FD-249  
225 mm



YASARGIL  
**FD-423**  
200 mm

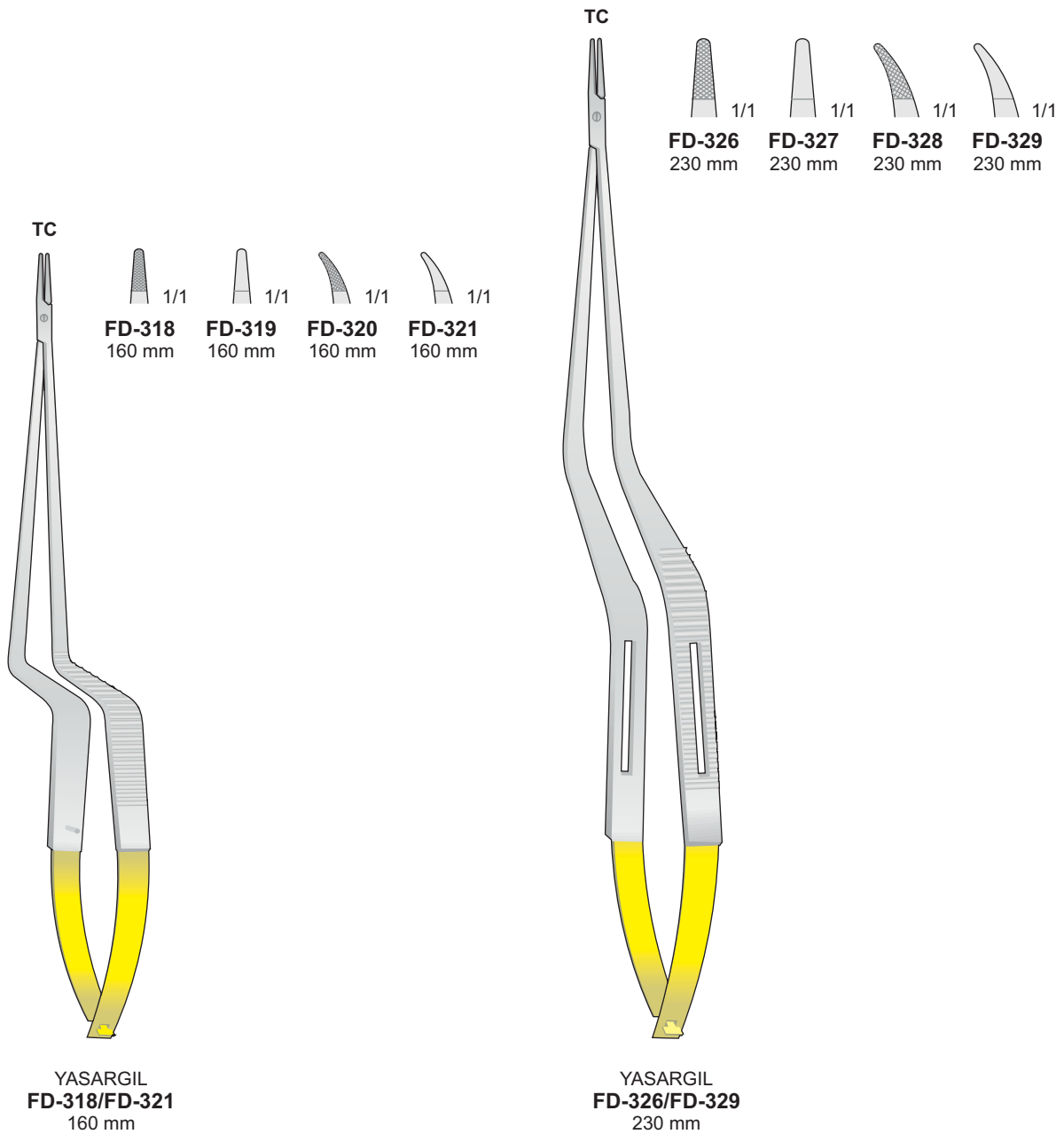
YASARGIL  
**FD-420**  
200 mm

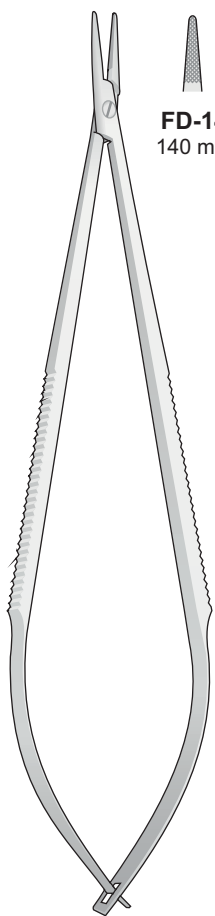



YASARGIL  
**FD-421**  
225 mm




Portaghi con inserti al tungsteno  
 Needle Holders with tungsten-carbide inserts  
 Nadelhalter mit Hartmetalleinlagen  
 Porte aiguilles avec plaquettes en carbure de tungstène  
 Portaagujas con plaquitas de carburo de tungsteno

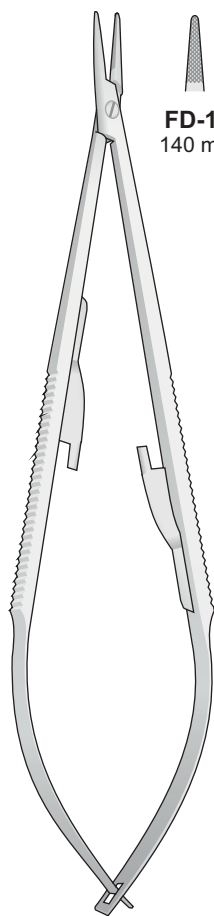






 1/1  
**FD-14**  
140 mm

 1/1  
**FD-16**  
140 mm

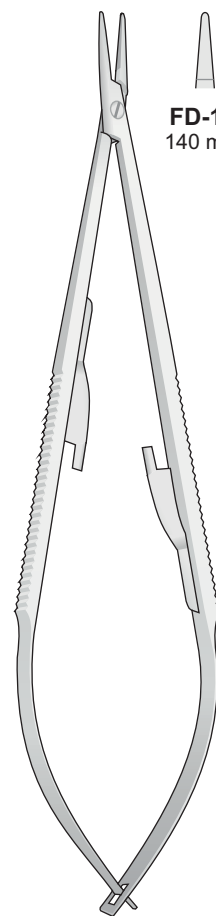
**FD-14/FD-16**  
140 mm





 1/1  
**FD-18**  
140 mm

 1/1  
**FD-20**  
140 mm

**CASTROVIEJO**  
**FD-18/FD-20**  
140 mm



 1/1  
**FD-17**  
140 mm

 1/1  
**FD-19**  
140 mm

**CASTROVIEJO**  
**FD-17/FD-19**  
140 mm

Con morso liscio  
With smooth jaws  
Mit Glatten maul  
Avec mors lisses  
Con mandibula lisa

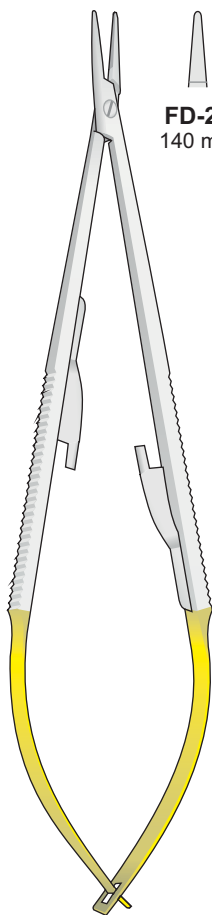




Portaghi con inserti al tungsteno  
 Needle Holders with tungsten-carbide inserts  
 Nadelhalter mit Hartmetalleinlagen  
 Porte aiguilles avec plaquettes en carbure de tungstène  
 Portaagujas con plaquitas de carburo de tungsteno

Con morso liscio  
 With smooth jaws  
 Mit Glatten mau  
 Avec mors lisses  
 Con mandibula lisa

TC



1/1

**FD-21**  
140 mm

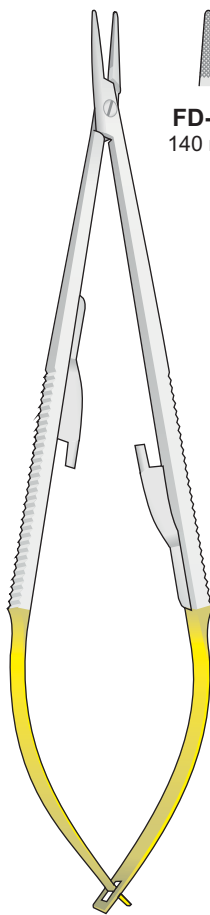


1/1

**FD-23**  
140 mm

CASTROVIEJO  
**FD-21/FD-23**  
 140 mm

TC



1/1

**FD-22**  
140 mm

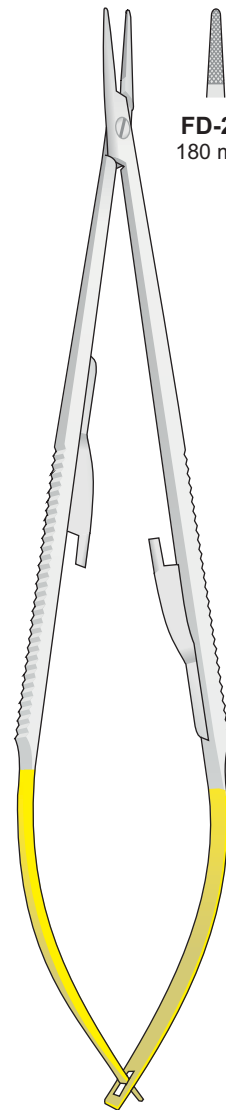


1/1

**FD-28**  
140 mm

CASTROVIEJO  
**FD-22/FD-28**  
 140 mm

TC



1/1

**FD-25**  
180 mm



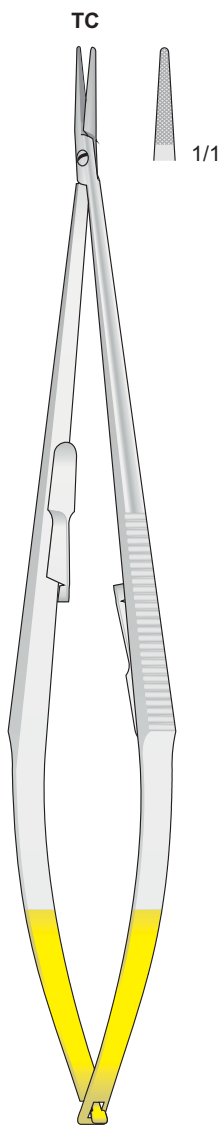
1/1

**FD-29**  
180 mm

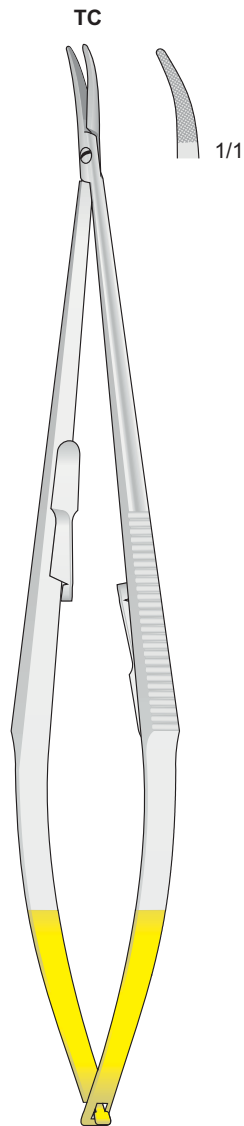
CASTROVIEJO  
**FD-25/FD-29**  
 180 mm



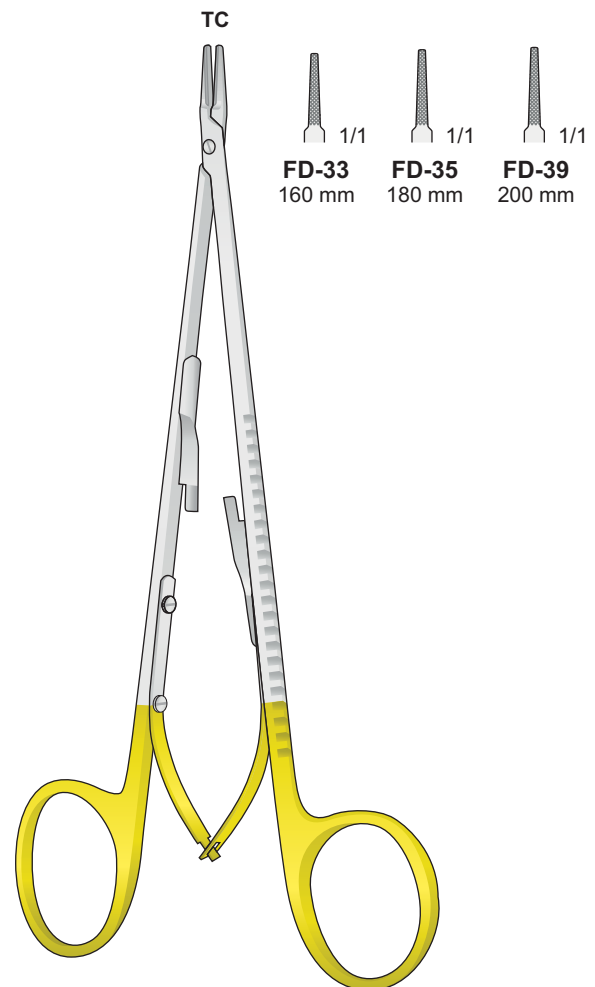
Portaghi con inserti al tungsteno  
Needle Holders with tungsten-carbide inserts  
Nadelhalter mit Hartmetalleinlagen  
Porte aiguilles avec plaquettes en carbure de tungstène  
Portaagujas con plaquitas de carburo de tungsteno



CASTROVIEJO  
FD-27  
215 mm



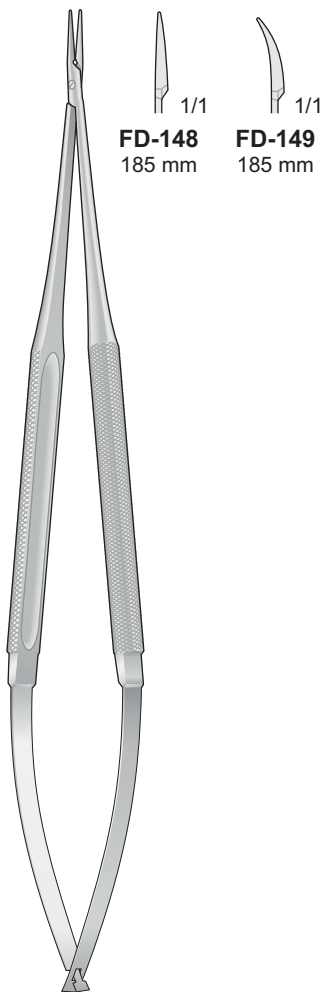
CASTROVIEJO  
FD-128  
215 mm



DIETRICH  
FD-33/FD-39

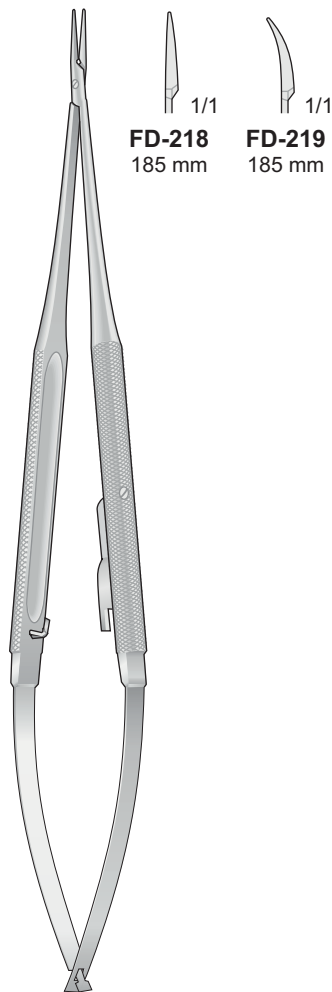


Con morso liscio  
With smooth jaws  
Mit Glatten mau  
Avec mors lisses  
Con mandibula lisa



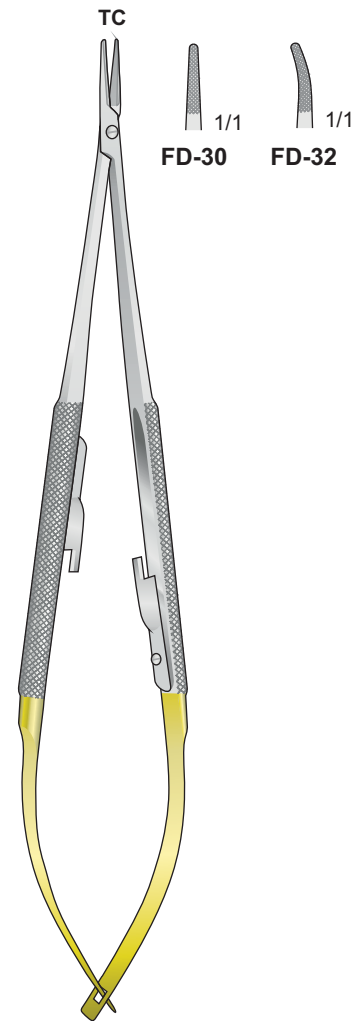
**FD-148/FD-149**  
185 mm

Con morso liscio  
With smooth jaws  
Mit Glatten mau  
Avec mors lisses  
Con mandibula lisa



**FD-218/FD-219**  
185 mm

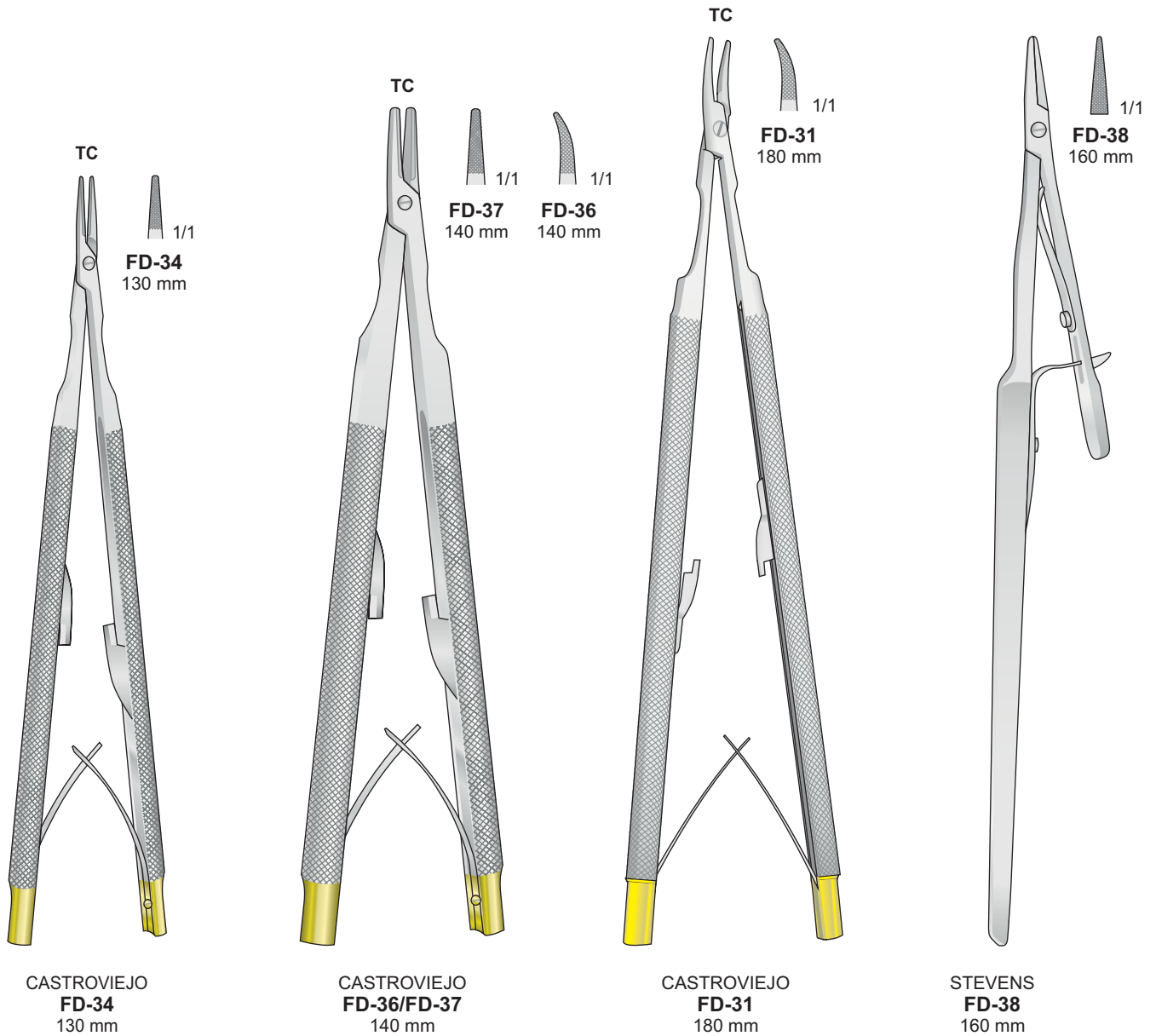
Portaghi con inserti al tungsteno  
Needle Holders with tungsten-carbide inserts  
Nadelhalter mit Hartmetalleinlagen  
Porte aiguilles avec plaquettes en carbure de tungstène  
Portaagujas con plaquitas de carburo de tungsteno



**JACOBSON**  
**FD-30/FD-32**  
180 mm

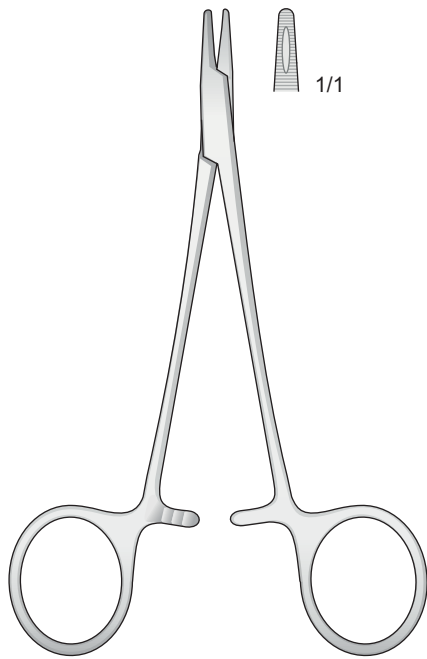


Portaghi con inserti al tungsteno  
 Needle Holders with tungsten-carbide inserts  
 Nadelhalter mit Hartmetalleinlagen  
 Porte aiguilles avec plaquettes en carbure de tungstène  
 Portaagujas con plaquitas de carburo de tungsteno

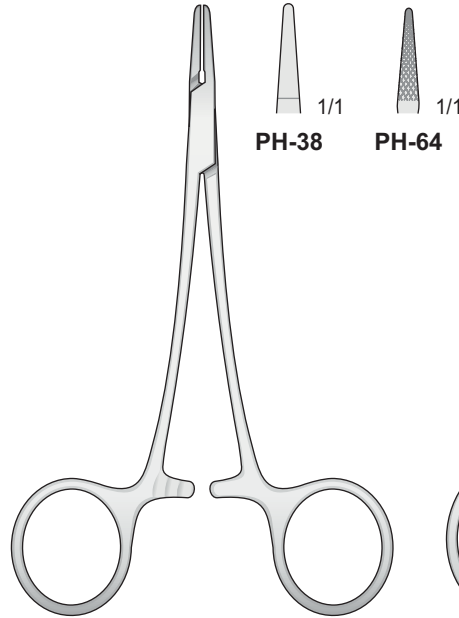




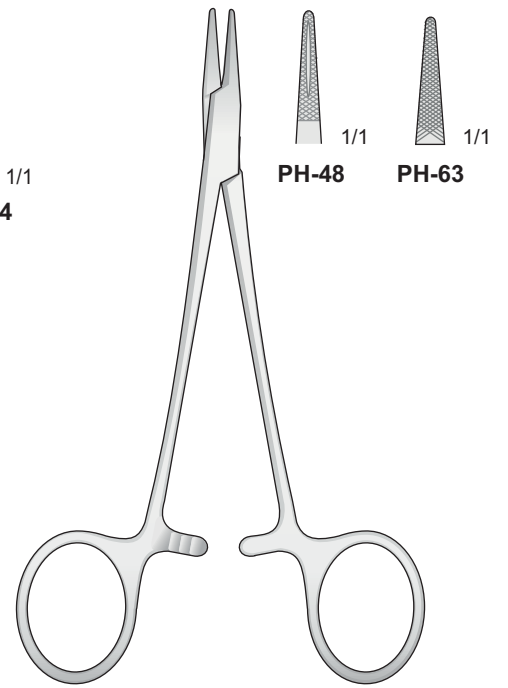
Con morso liscio  
With smooth jaws  
Mit Glatten maul  
Avec mors lisses  
Con mandibula lisa



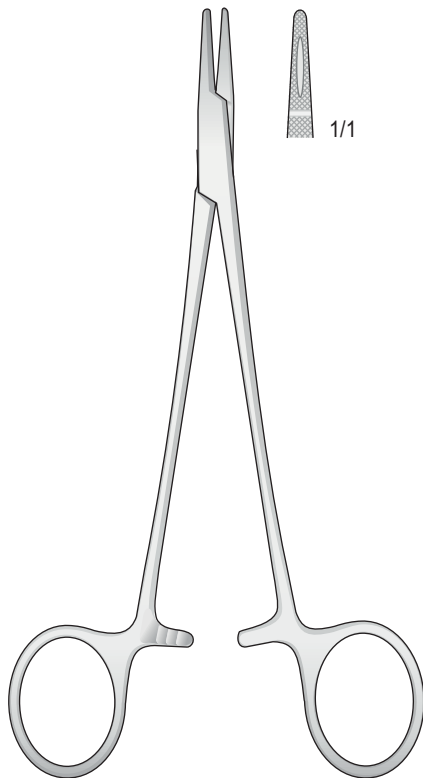
DERF  
PH-39  
125 mm



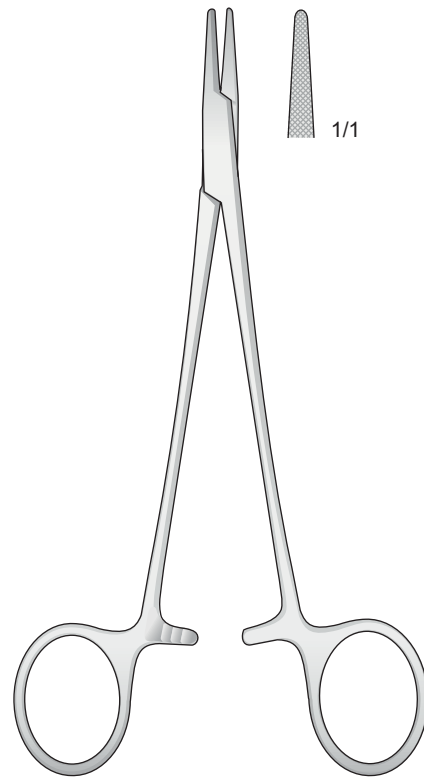
PH-38/PH-64  
120 mm



HALSEY  
PH-48/PH-63  
130 mm



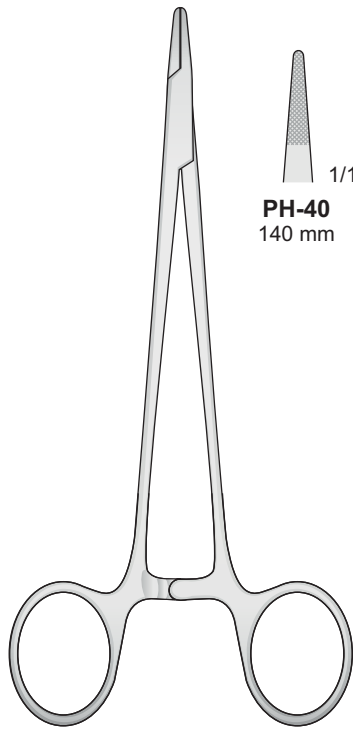
CRILE-WOOD  
PH-61  
150 mm



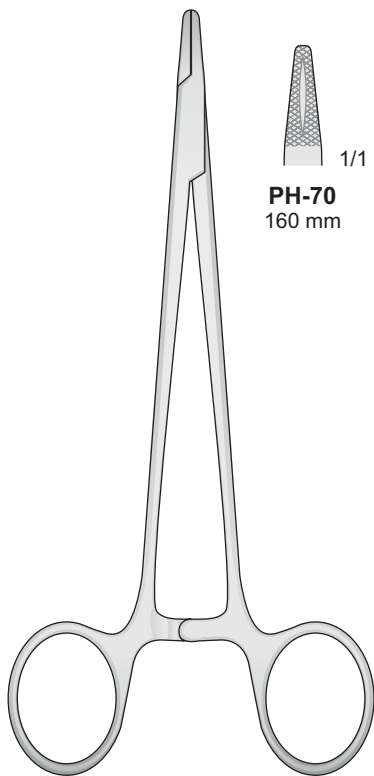
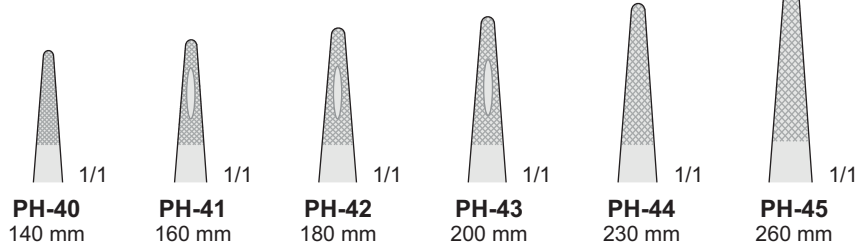
CRILE-MURRAY  
PH-62  
150 mm



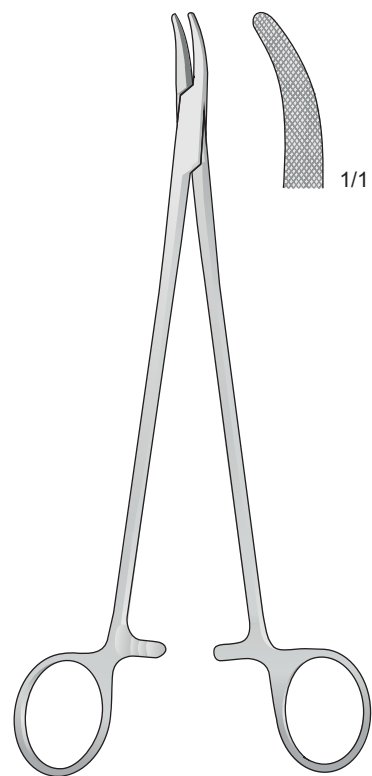
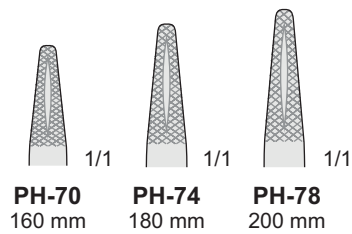
Modello fine - Delicate pattern - Schlankes Modell  
Modèle fin - Modelo delegado



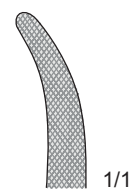
MAYO-HEGAR  
PH-40/PH-45

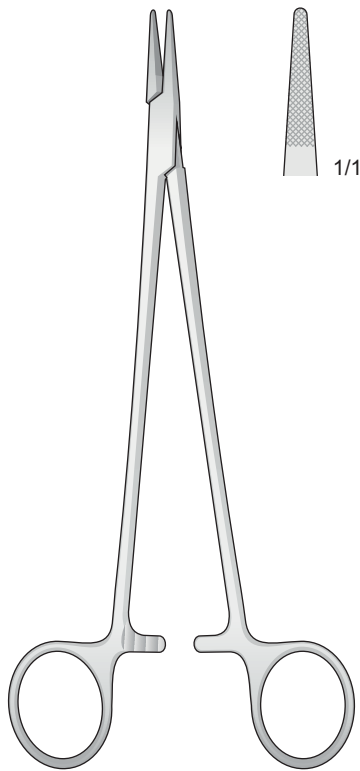


HEGAR  
PH-70/PH-78

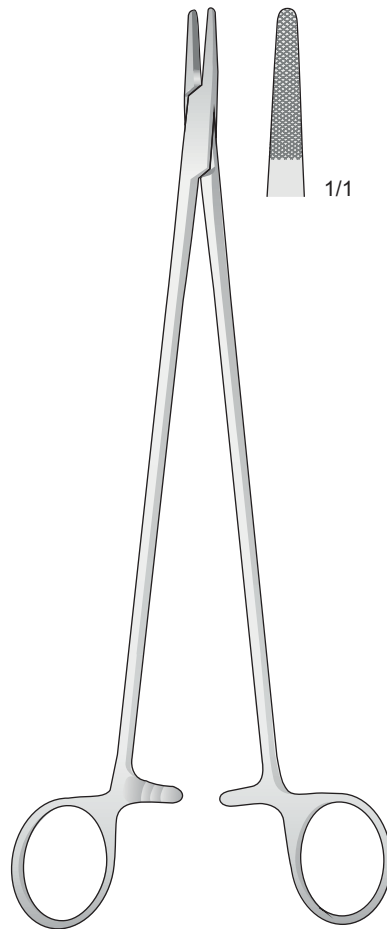


HEANEY (HEGAR)  
PH-52  
200 mm

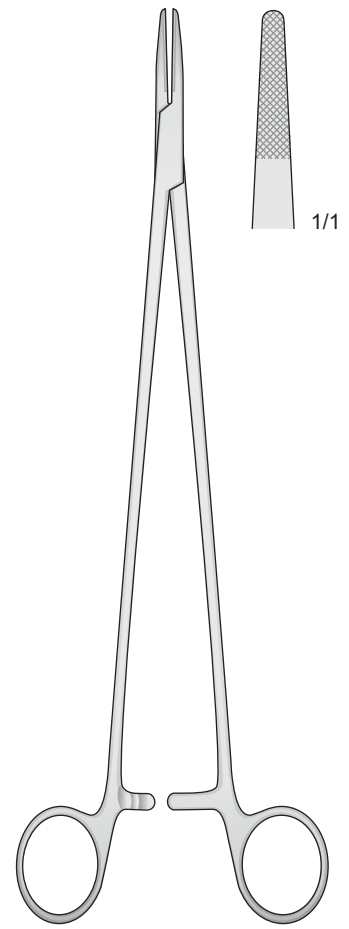




HEGAR-MAYO-SEELEY  
**PH-46**  
200 mm



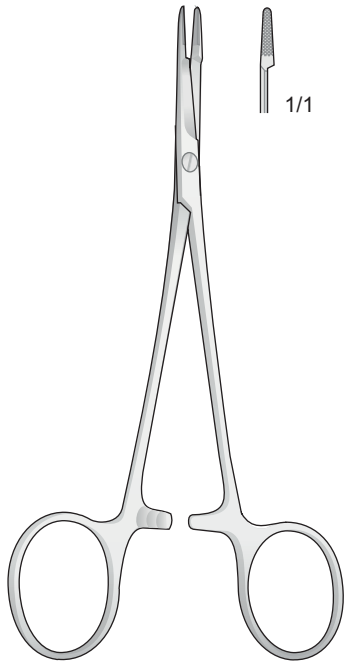
MASSON  
**PH-47**  
270 mm



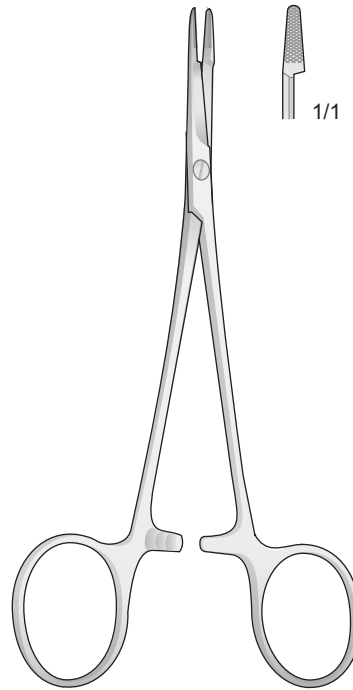
WANGENSTEEN  
**PH-49**  
270 mm



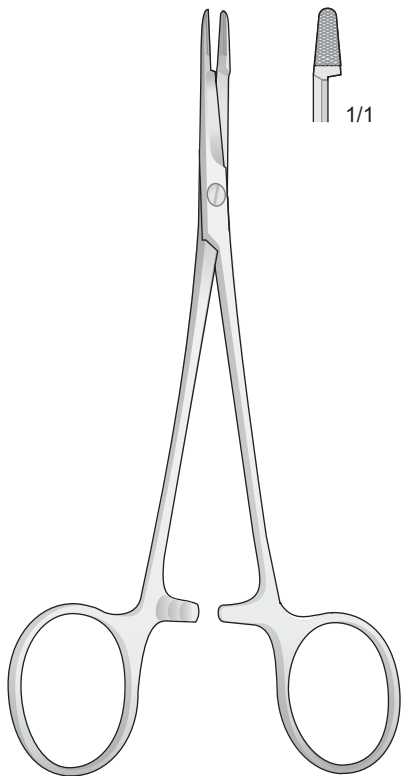
Port'aghi con forbici - Needle holders with scissors - Nadelhalter mit Schere - Porte aiguilles avec ciseaux - Portaagujas con tijeras



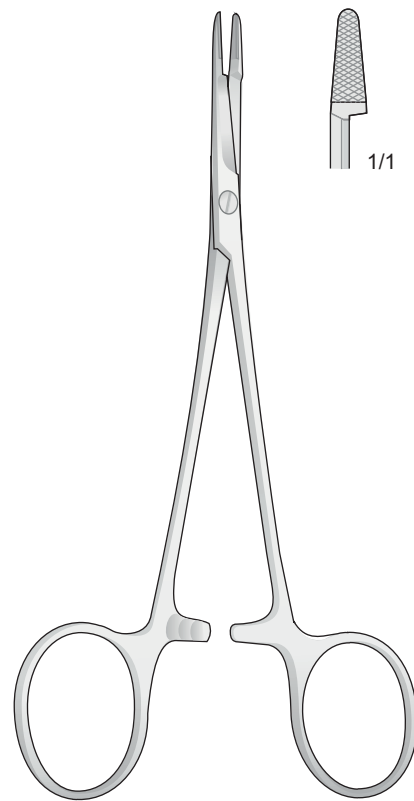
MINI-OLSEN-HEGAR  
**BM-61**  
120 mm



OLSEN-HEGAR  
**BM-62**  
140 mm



OLSEN-HEGAR  
**BM-63**  
170 mm

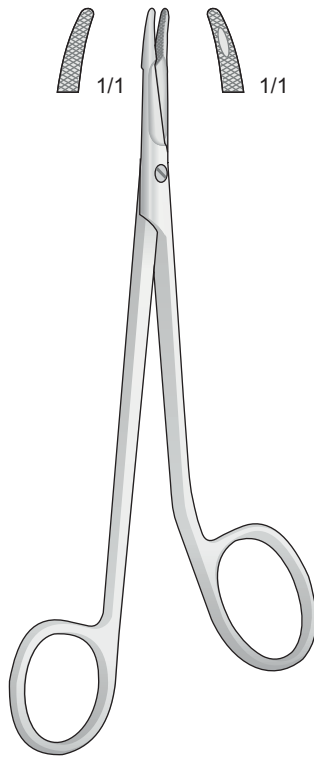


OLSEN-HEGAR  
**BM-64**  
190 mm

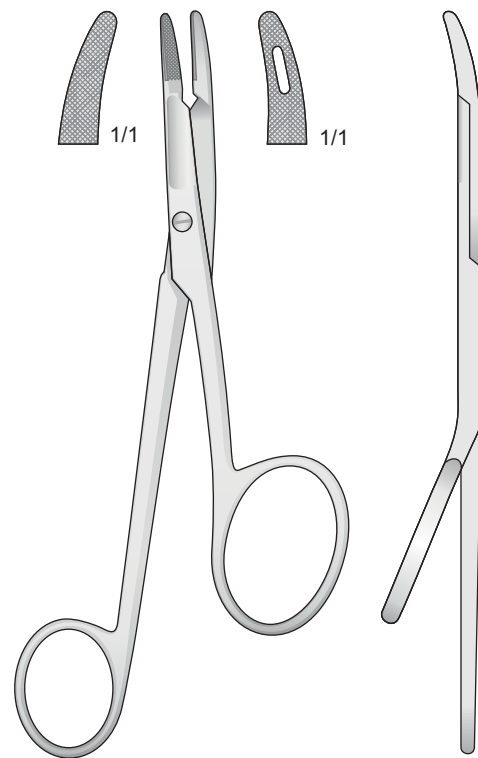




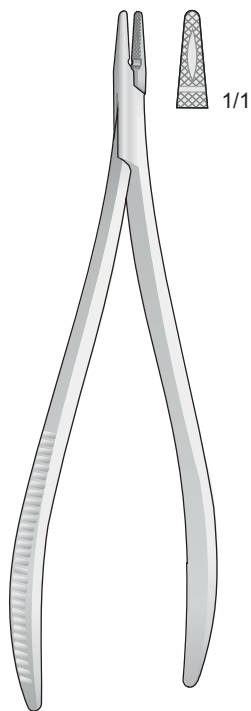
Port'aghi con forbici - Needle holders with scissors - Nadelhalter mit Schere - Porte aiguilles avec ciseaux - Portaagujas con tijeras



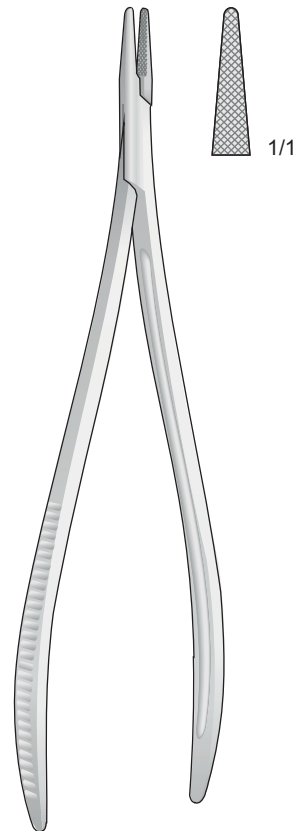
MINI-GILLIES  
**PO-59**  
145 mm



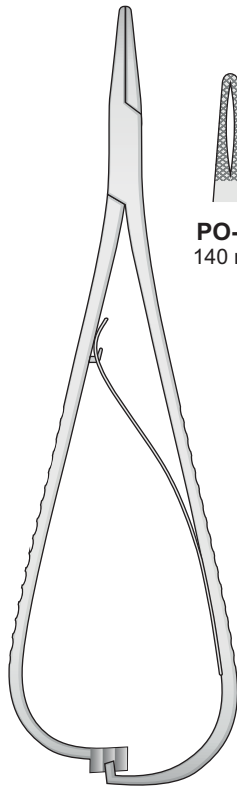
GILLIES  
**PO-89**  
160 mm



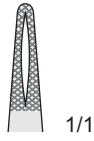
CRILE  
**PO-37**  
150 mm



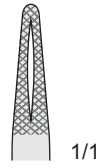
TÖNNIS  
**PO-38**  
190 mm



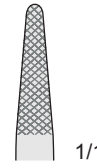
MATHIEU  
PO-78/PO-91



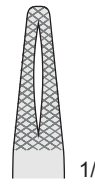
PO-78  
140 mm



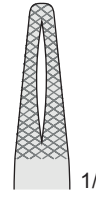
PO-81  
170 mm



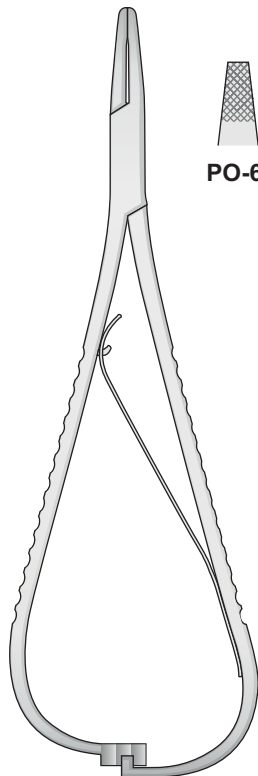
PO-65  
170 mm



PO-90  
200 mm



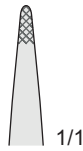
PO-91  
240 mm



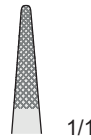
MATHIEU  
PO-60/PO-80  
140 mm



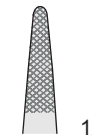
PO-60



PO-71



PO-79



PO-80



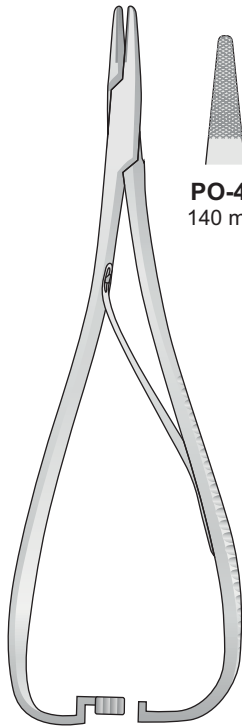
Port'aghi

Needle Holders

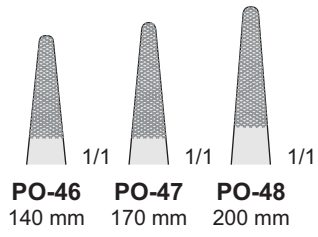
Nadelhalter

Porte aiguilles

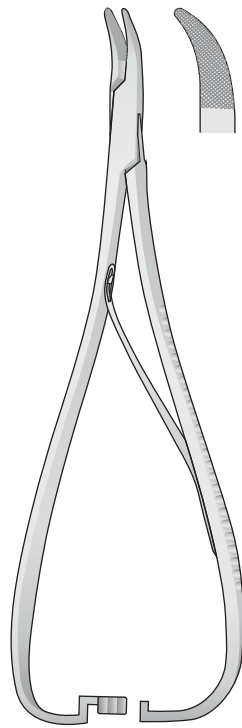
Portaagujas



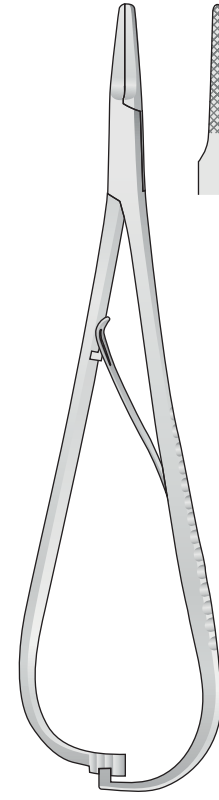
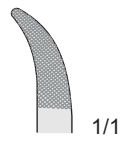
MATHIEU  
PO-46/PO-48



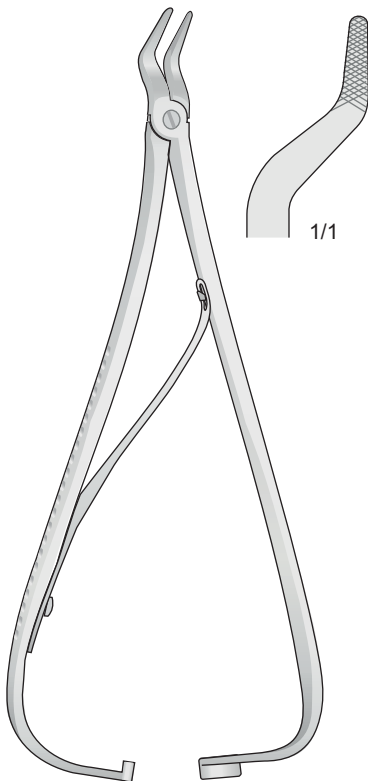
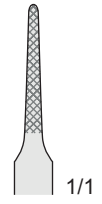
PO-46 140 mm  
PO-47 170 mm  
PO-48 200 mm



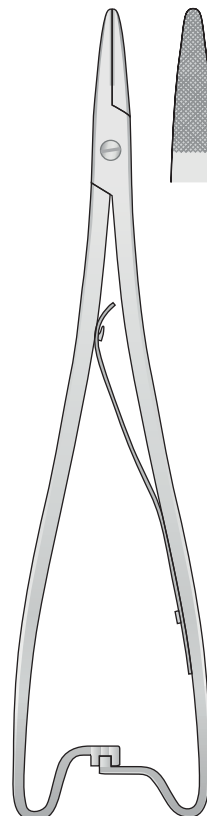
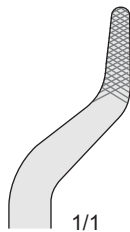
PO-40  
140 mm



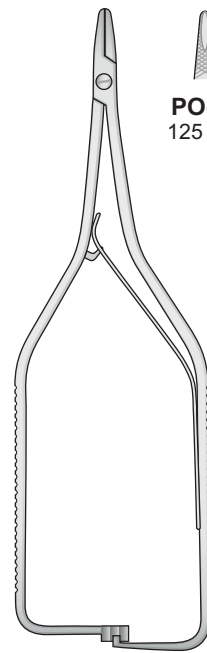
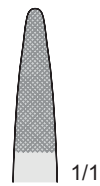
STILLE  
PO-74  
170 mm



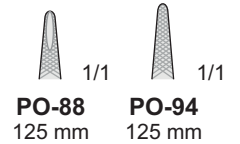
EISELBERG-MATHIEU  
PO-75  
180 mm



MATHIEU  
PO-67  
200 mm

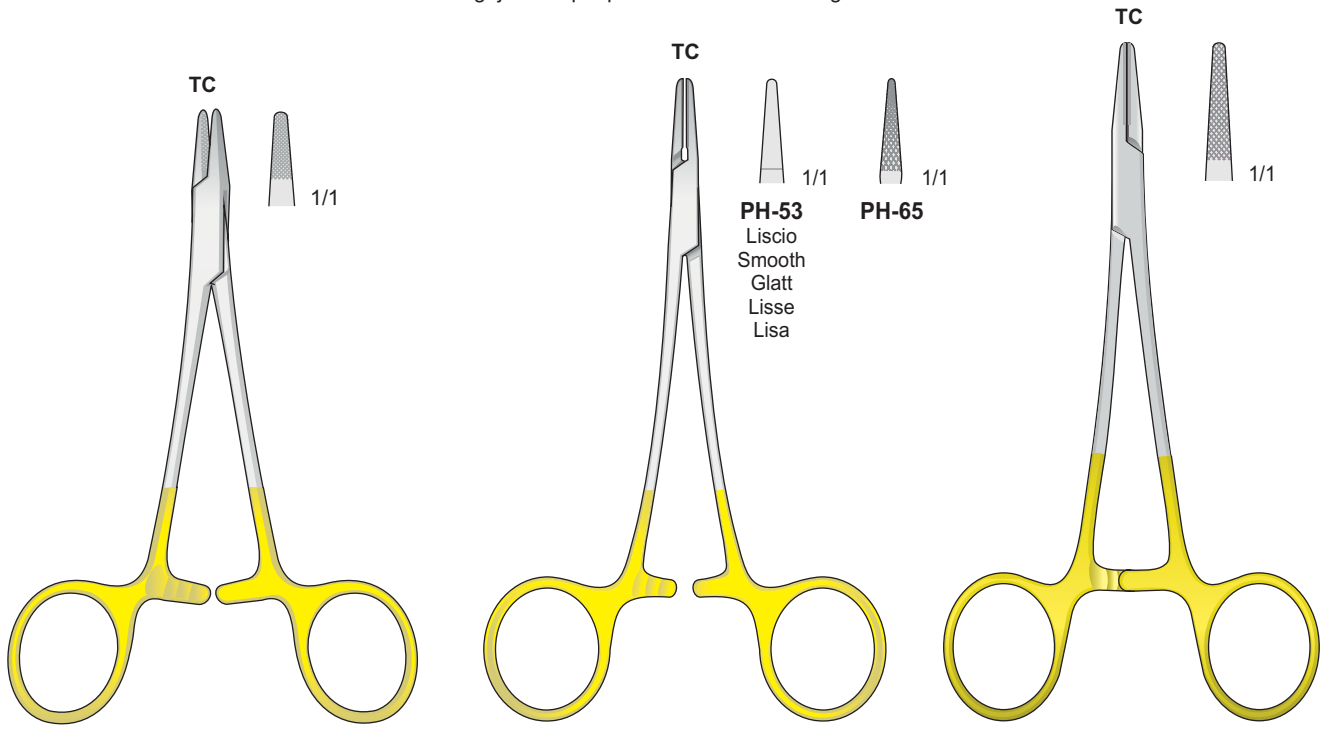


BOYNTON  
PO-88/PO-94  
125 mm





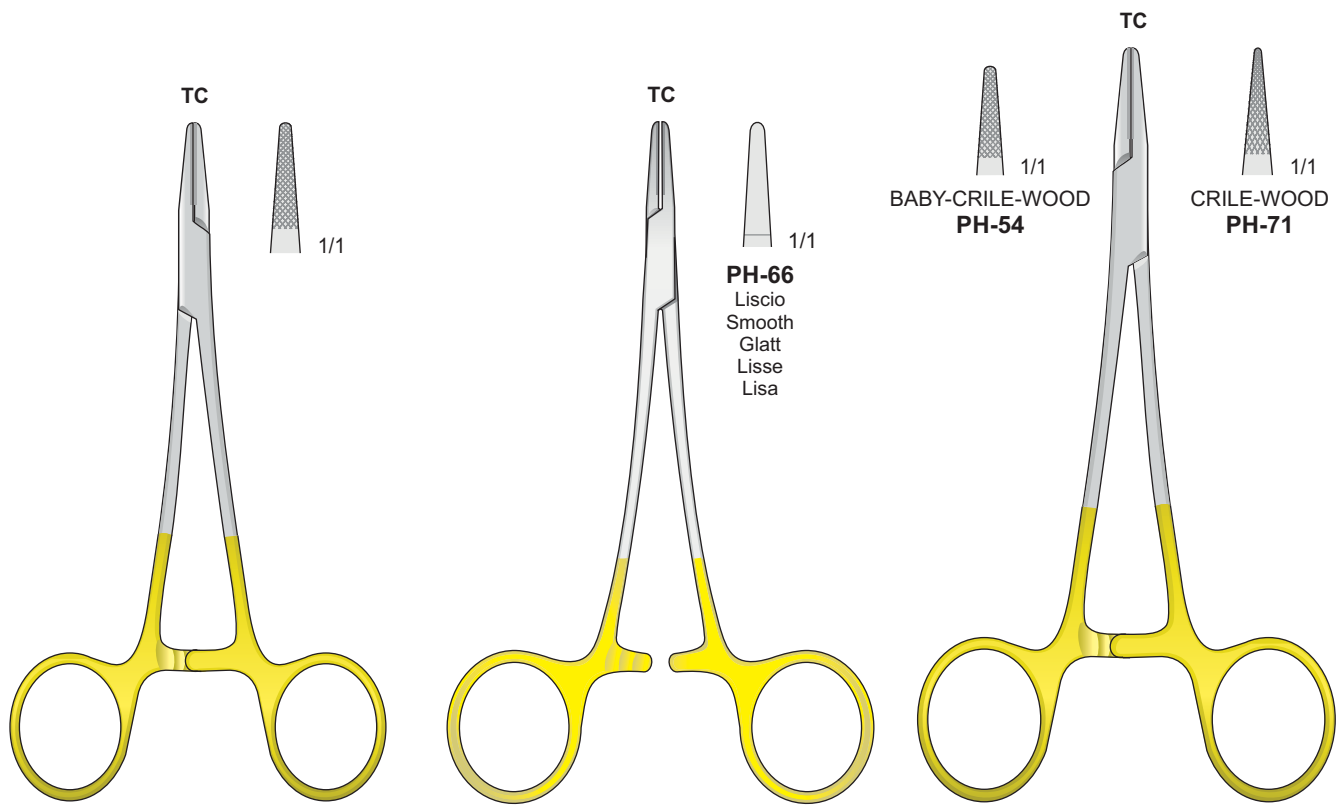
Portaghi con inserti al tungsteno - Needle Holders with tungsten-carbide inserts  
Nadelhalter mit Hartmetalleinlagen - Porte aiguilles avec plaquettes en carbure de tungstène  
Portaagujas con plaquitas de carburo de tungsteno



DERF  
**PH-69**  
115 mm

**PH-53/PH-65**  
120 mm

CONVERSE  
**PH-68**  
130 mm



HALSEY  
**PH-73**  
130 mm

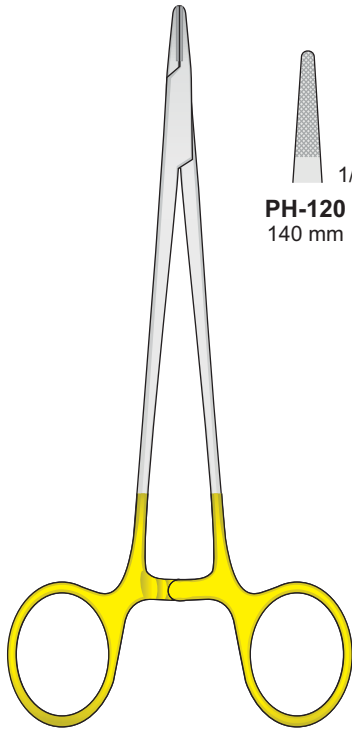
WEBSTER  
**PH-66**  
130 mm

CRILE-WOOD  
**PH-54/PH-71**  
150 mm

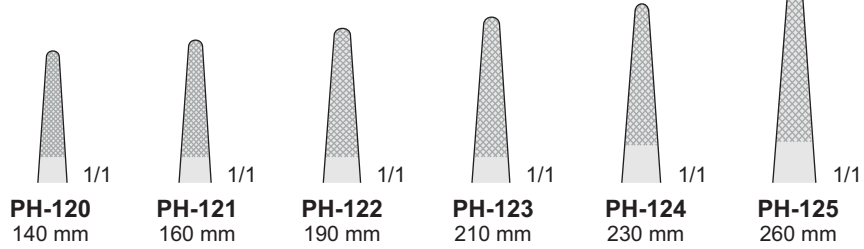


Portaghi con inserti al tungsteno - Needle Holders with tungsten-carbide inserts  
Nadelhalter mit Hartmetalleinlagen - Porte aiguilles avec plaquettes en carbure de tungstène  
Portaagujas con plaquitas de carburo de tungsteno

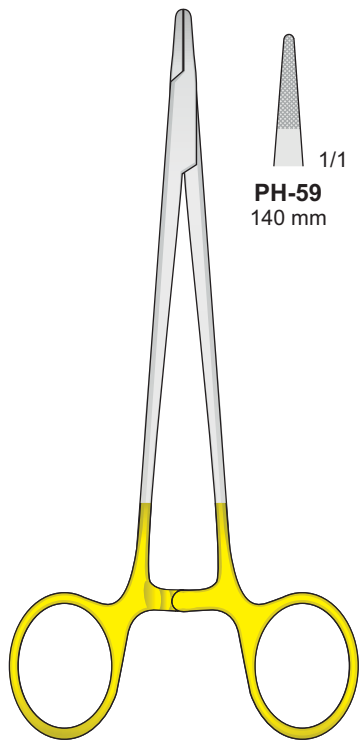
TC



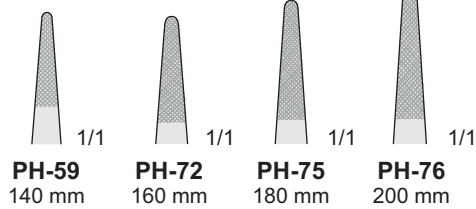
MAYO-HEGAR  
PH-120/PH-125



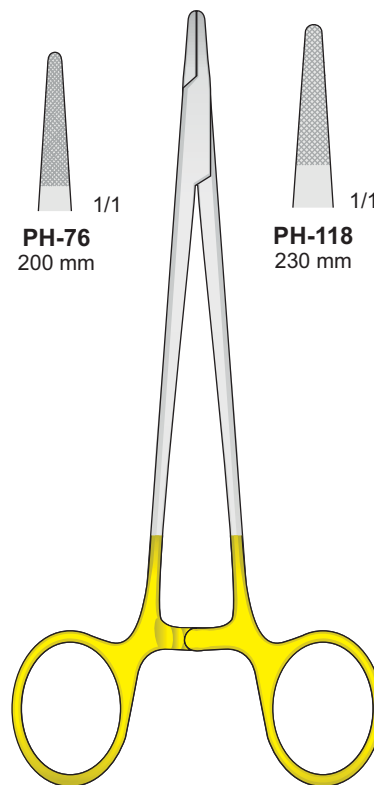
TC



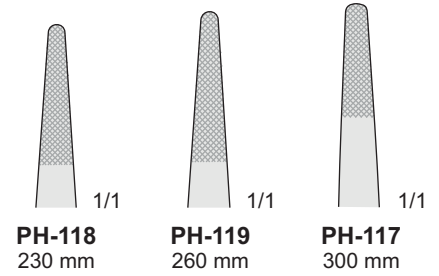
HEGAR  
PH-59/PH-76



TC



MAYO-HEGAR  
PH-117/PH-119





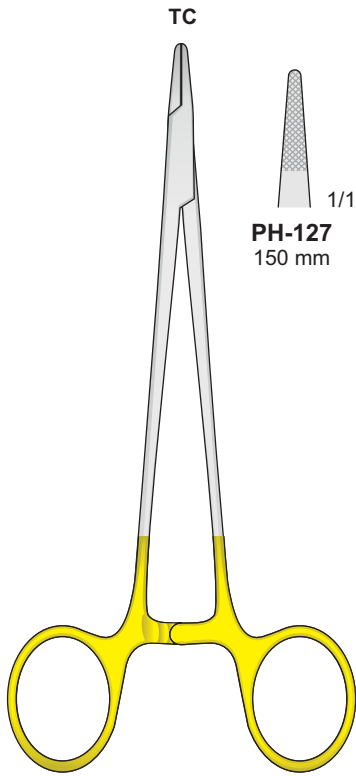
Port'aghi

Needle Holders

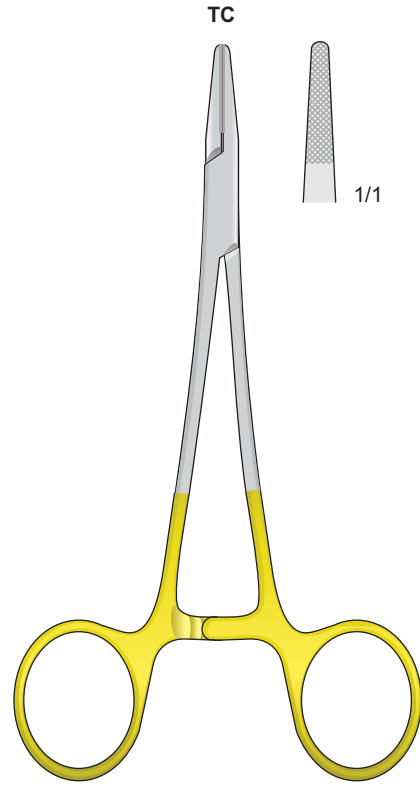
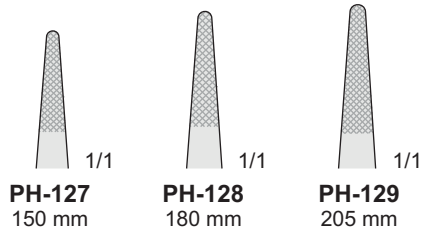
Nadelhalter

Porte aiguilles

Portaagujas

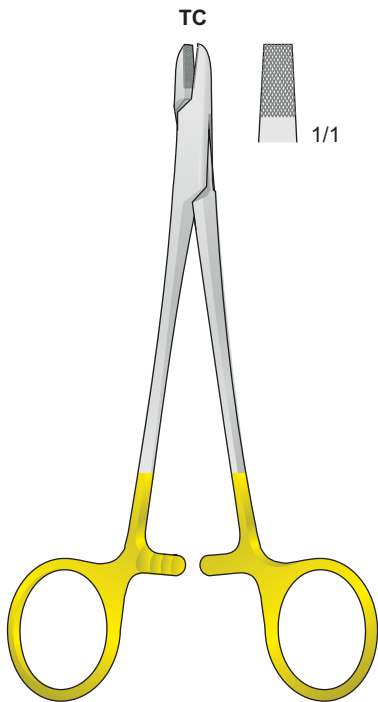


MAYO-HEGAR-FINO  
PH-127/PH-129

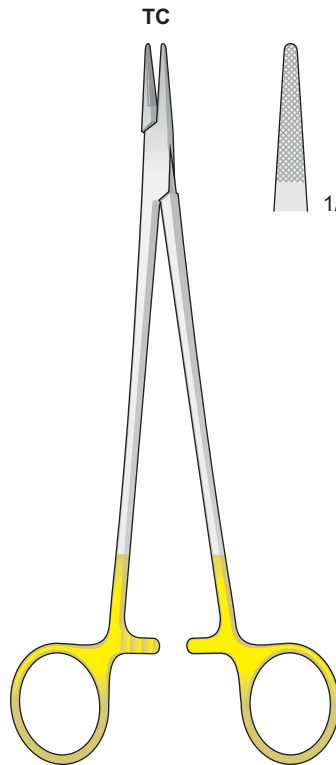
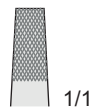


CRILE-WOOD  
PH-77  
180 mm

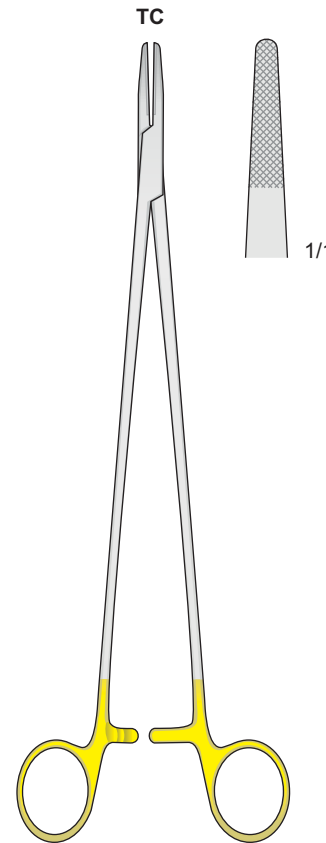
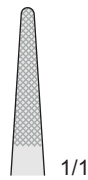
Port'aghi, pinze per fili d'acciaio  
Needle holder, wire forceps  
Nadelhalter, Draht-Zangen  
Porte-aiguilles, pinces à saisir  
Porta agujas, pinzas para hilos



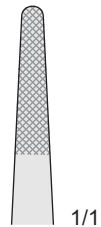
PH-58  
150 mm



HEGAR-MAYO-SEELEY  
PH-130  
200 mm

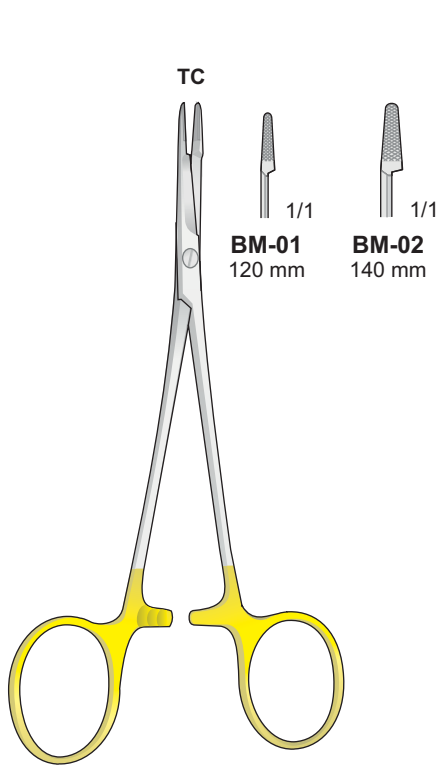


WANGENSTEEN  
PH-131  
270 mm

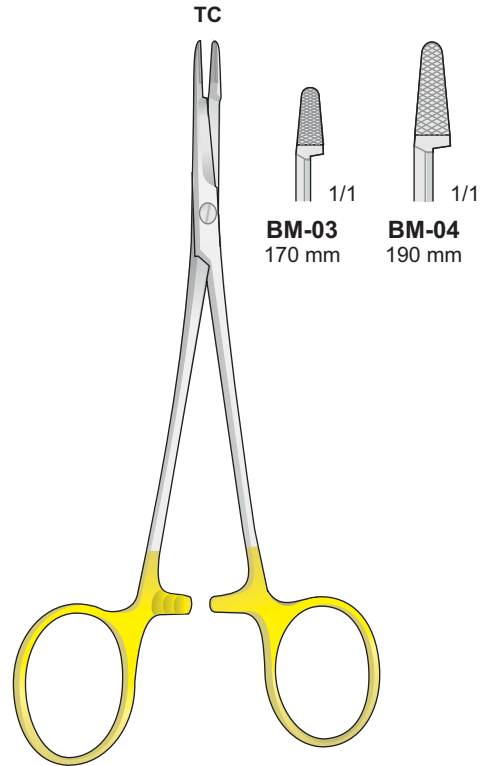




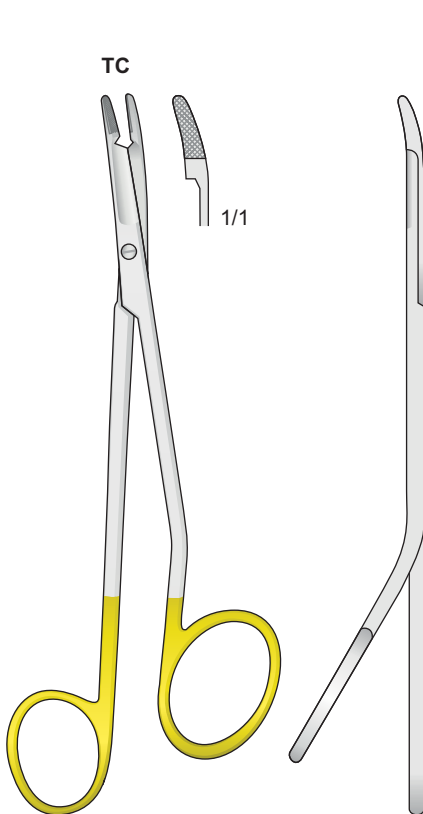
Port'aghi con forbici - Needle holders with scissors - Nadelhalter mit Schere - Porte aiguilles avec ciseaux - Portaagujas con tijeras



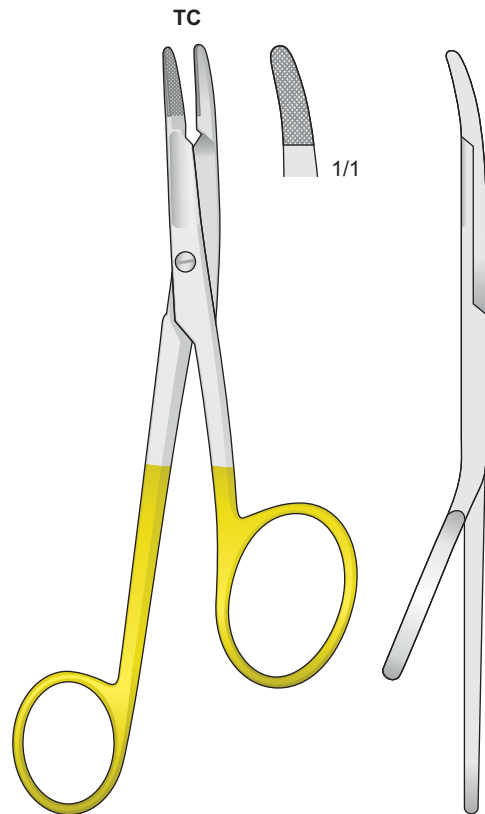
OLSEN-HEGAR  
BM-01/BM-02



OLSEN-HEGAR  
BM-03/BM-04



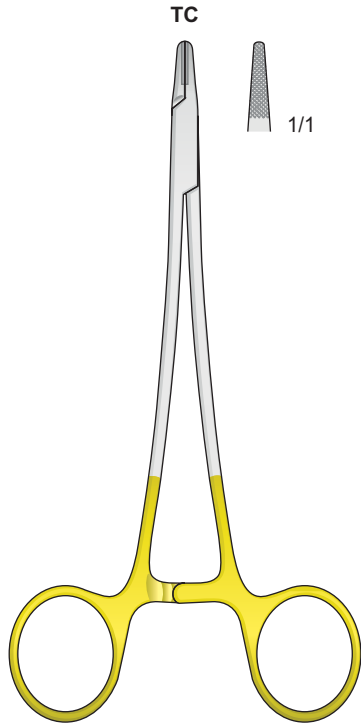
MINI-GILLIES  
PO-99  
145 mm



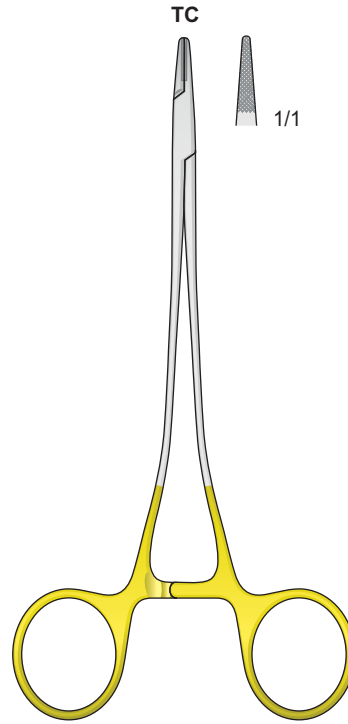
GILLIES  
PO-97  
160 mm



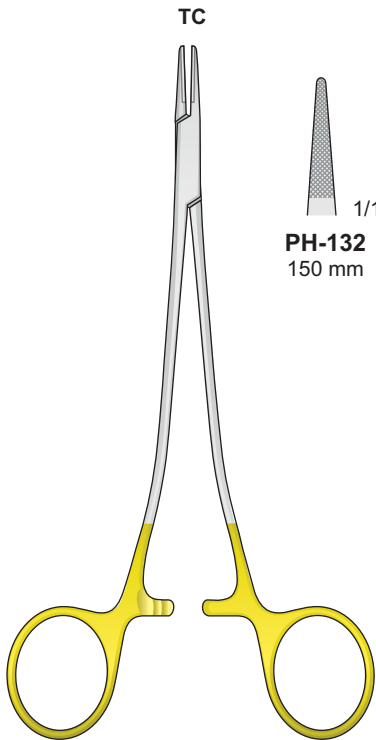
Portaghi con inserti al tungsteno - Needle Holders with tungsten-carbide inserts  
Nadelhalter mit Hartmetalleinlagen - Porte aiguilles avec plaquettes en carbure de tungstène  
Portaagujas con plaquitas de carburo de tungsteno



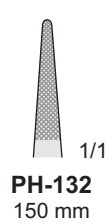
**PH-79**  
145 mm



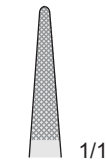
**PH-85**  
150 mm



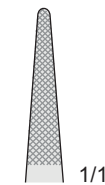
SAROT  
**PH-132/PH-134**



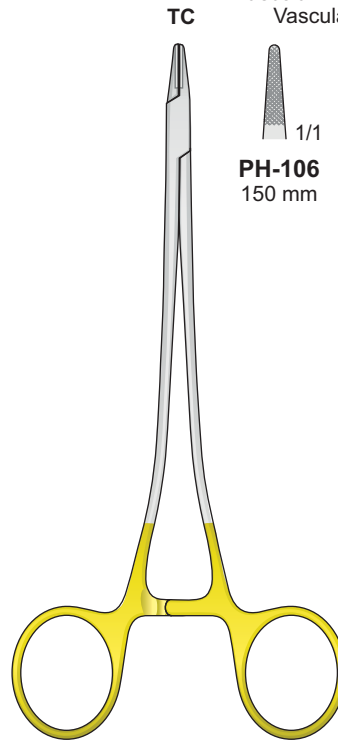
**PH-132**  
150 mm



**PH-133**  
180 mm

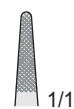


**PH-134**  
210 mm

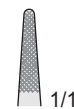


SWEDISH MOD.  
**PH-106/PH-108**

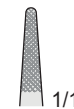
Vascolari - Vascular - Vasculares  
Vasculaires - Vasculares



**PH-106**  
150 mm



**PH-107**  
180 mm



**PH-108**  
200 mm

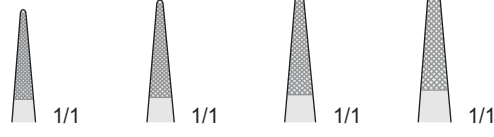
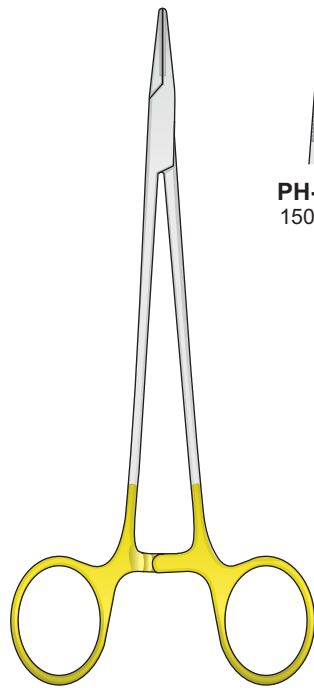




Portaghi con inserti al tungsteno - Needle Holders with tungsten-carbide inserts  
Nadelhalter mit Hartmetalleinlagen - Porte aiguilles avec plaquettes en carbure de tungstène  
Portaagujas con plaquitas de carburo de tungsteno

TC

Vascolari - Vascular - Vasculares  
Vasculaires - Vasculares



**PH-101**  
150 mm

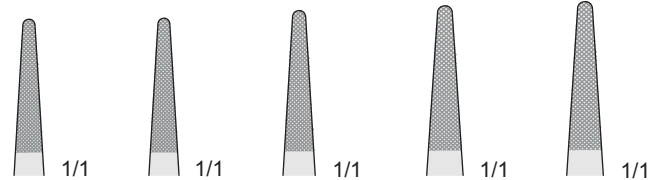
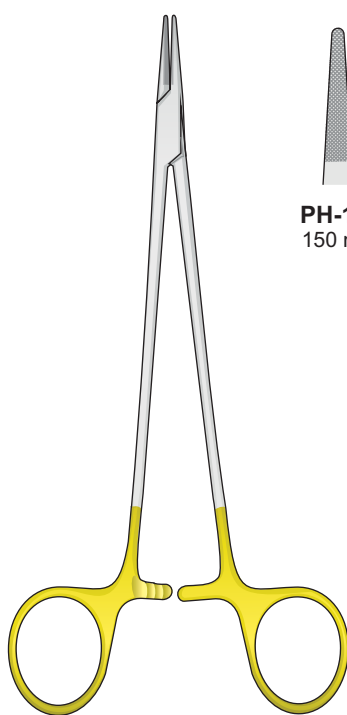
**PH-102**  
180 mm

**PH-103**  
200 mm

**PH-104**  
230 mm

MICRO-VASCULAR  
**PH-101/PH-104**

TC



**PH-110**  
150 mm

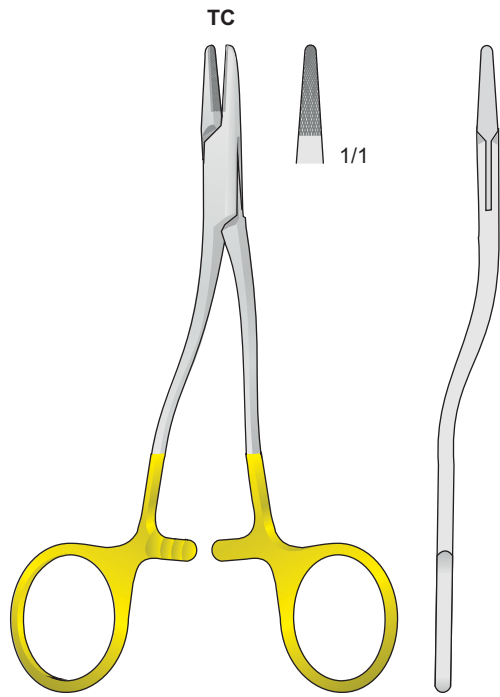
**PH-111**  
180 mm

**PH-112**  
230 mm

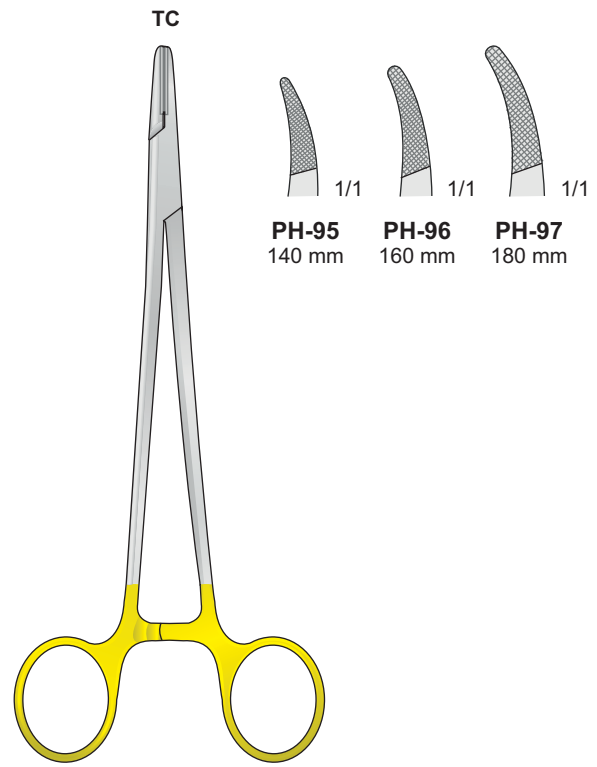
**PH-113**  
260 mm

**PH-114**  
305 mm

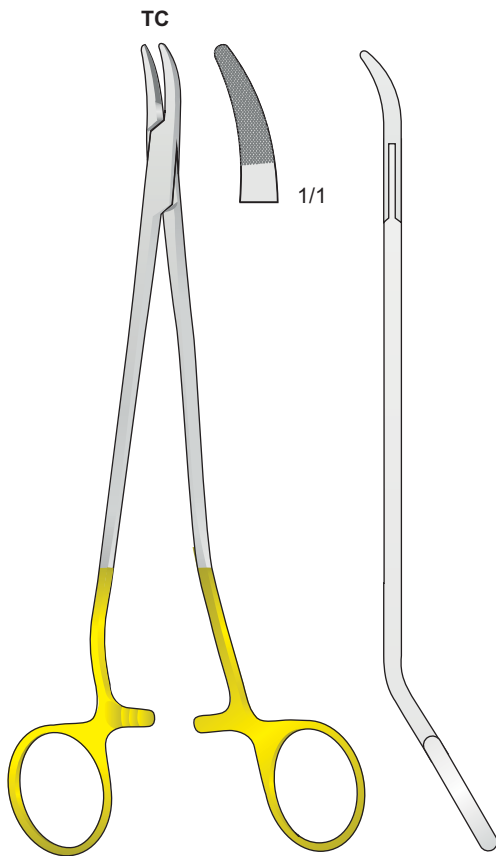
DE BAKEY  
**PH-110/PH-114**



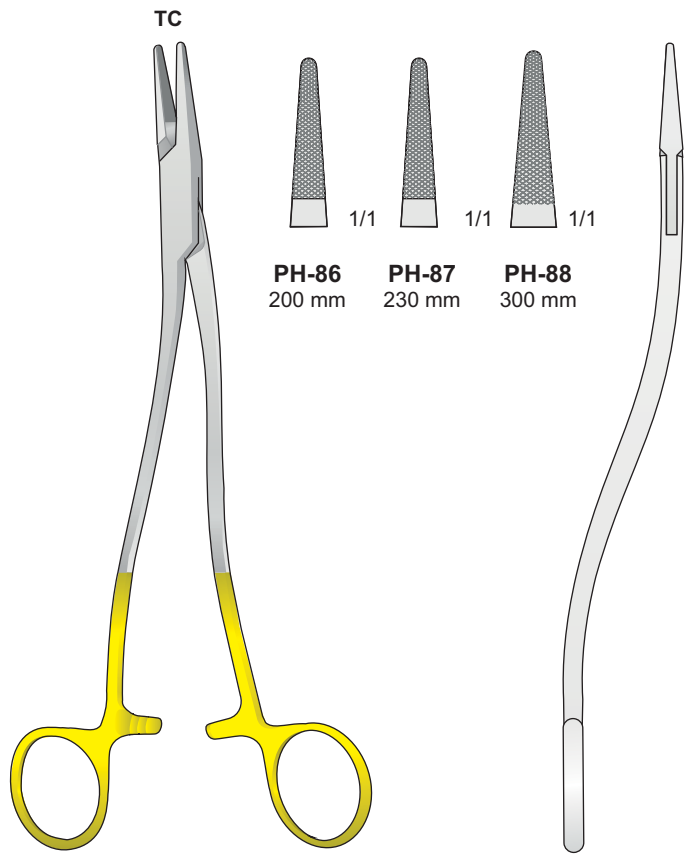
**KILNER  
PH-98  
130 mm**



**MAYO-HEGAR-HEANEY  
PH-95/PH-97**



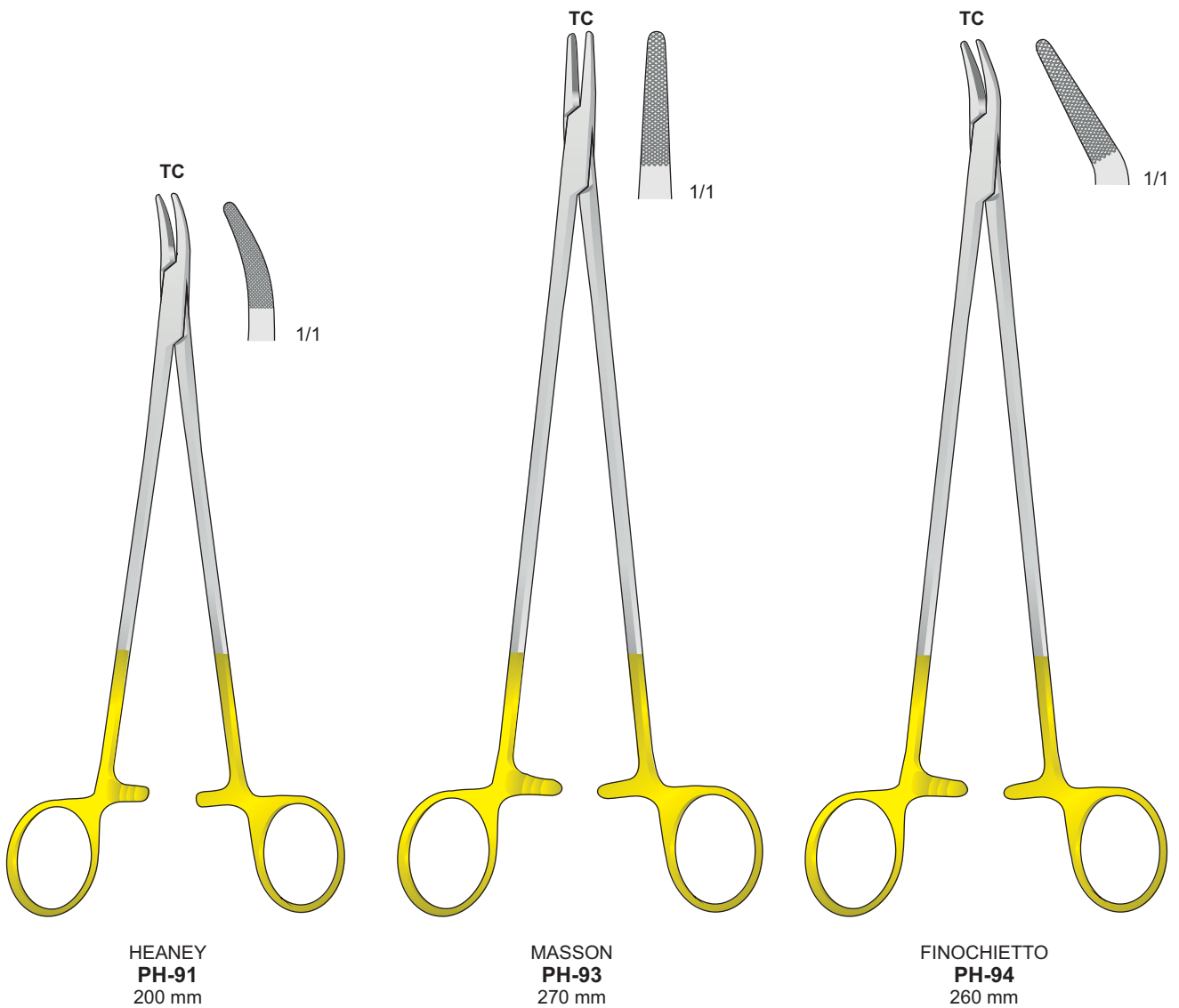
**S-FORMING  
PH-89  
200 mm**



**WERTHEIM  
PH-86/PH-88**

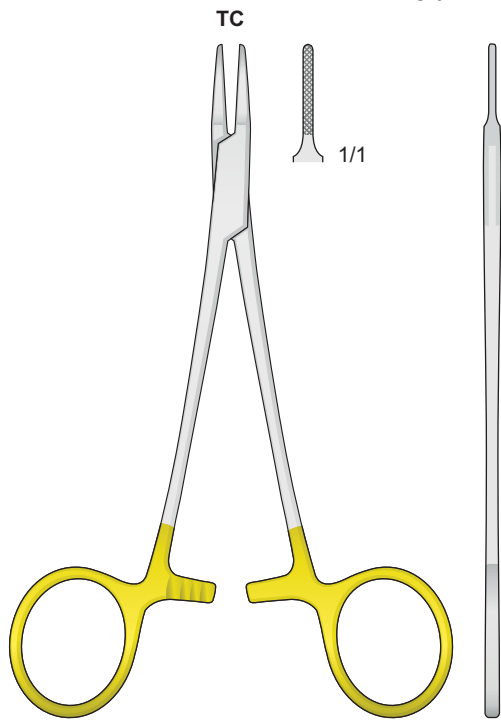


Portaghi con inserti al tungsteno - Needle Holders with tungsten-carbide inserts  
Nadelhalter mit Hartmetalleinlagen - Porte aiguilles avec plaquettes en carbure de tungstène  
Portaagujas con plaquitas de carburo de tungsteno

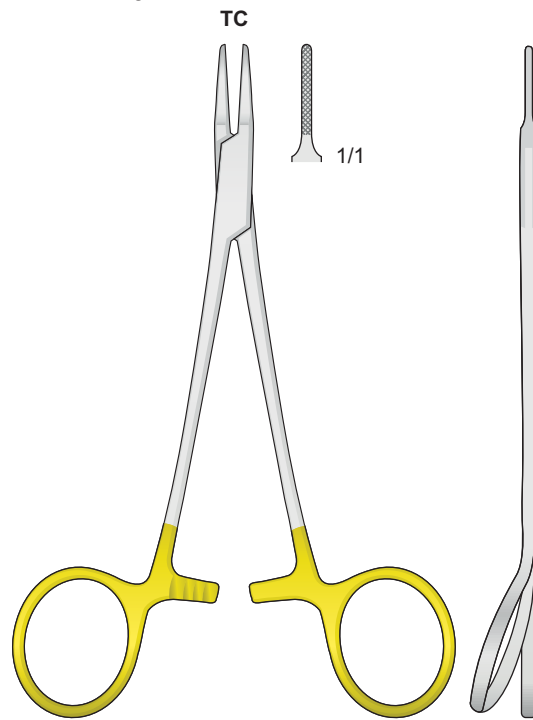




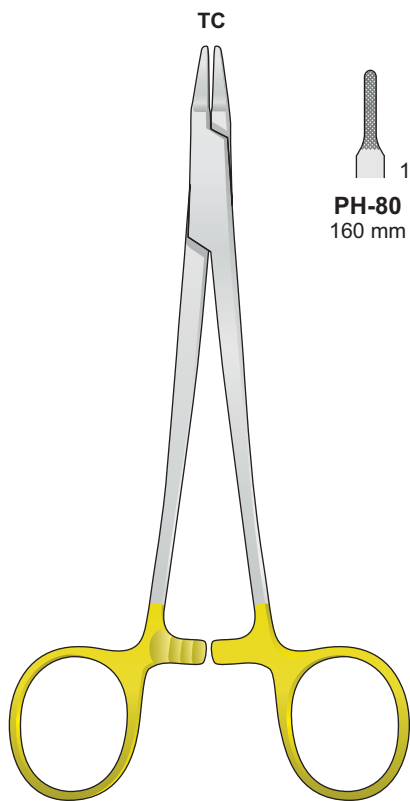
Portaghi con inserti al tungsteno - Needle Holders with tungsten-carbide inserts  
Nadelhalter mit Hartmetalleinlagen - Porte aiguilles avec plaquettes en carbure de tungstène  
Portaagujas con plaquitas de carburo de tungsteno



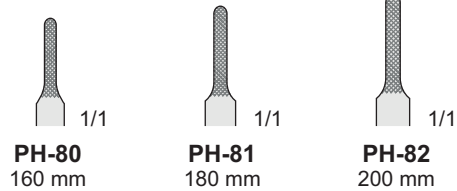
**MICRO-RYDER**  
**PH-83**  
140 mm



**PH-84**  
140 mm



**RYDER**  
**PH-80/PH-82**



**PH-80**  
160 mm

**PH-81**  
180 mm

**PH-82**  
200 mm



Port'aghi

Needle Holders

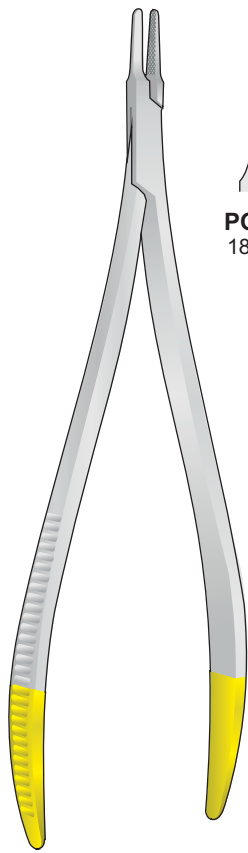
Nadelhalter

Porte aiguilles

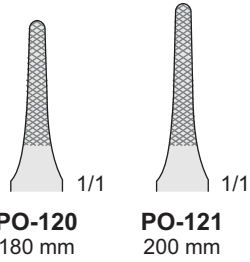
Portaagujas

Portaghi con inserti al tungsteno - Needle Holders with tungsten-carbide inserts  
Nadelhalter mit Hartmetalleinlagen - Porte aiguilles avec plaquettes en carbure de tungstène  
Portaagujas con plaquitas de carburo de tungsteno

TC



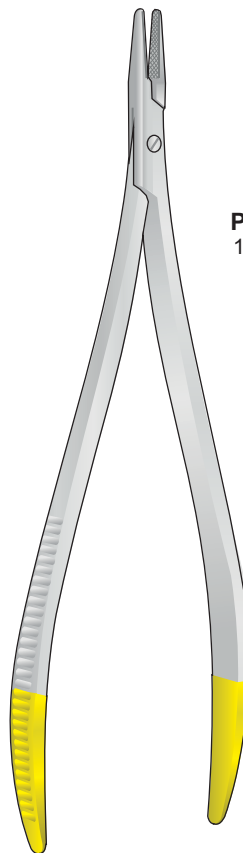
LANGENBECK-RYDER  
PO-120/PO-121



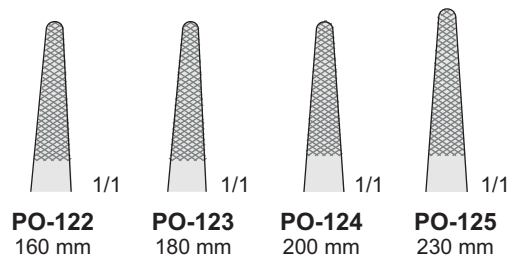
PO-120  
180 mm

PO-121  
200 mm

TC



LANGENBECK  
PO-122/PO-125



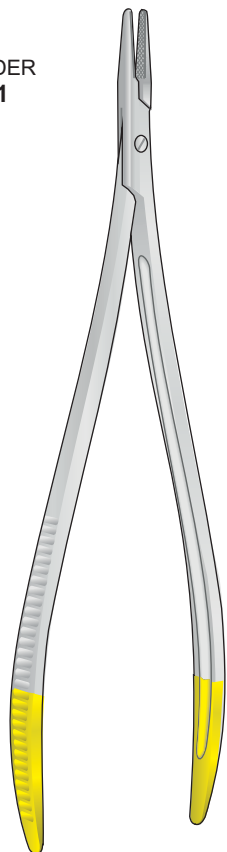
PO-122  
160 mm

PO-123  
180 mm

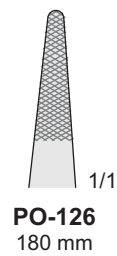
PO-124  
200 mm

PO-125  
230 mm

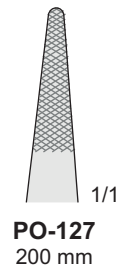
TC



TÖNNIS  
PO-126/PO-127

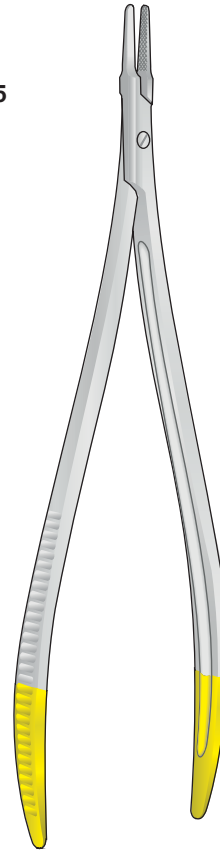


PO-126  
180 mm

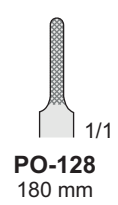


PO-127  
200 mm

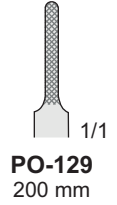
TC



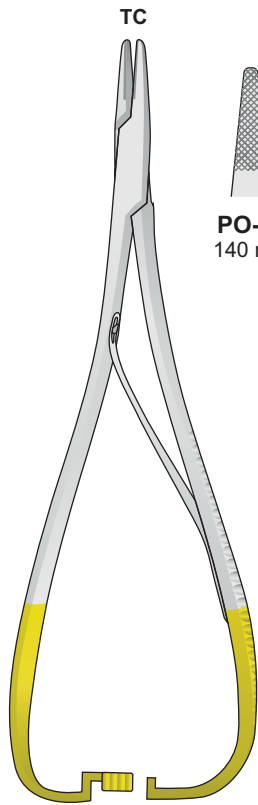
TÖNNIS-RYDER  
PO-128/PO-129



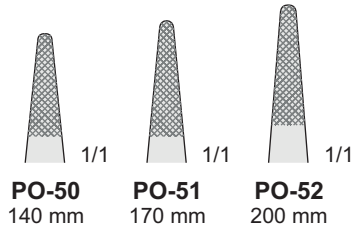
PO-128  
180 mm



PO-129  
200 mm



TC

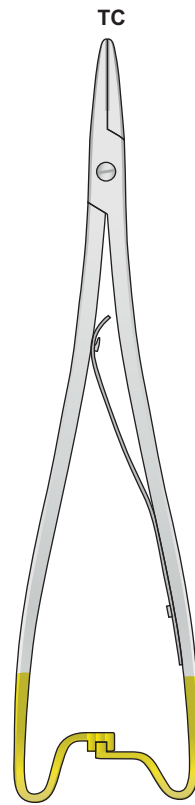


**PO-50**  
140 mm

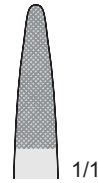
**PO-51**  
170 mm

**PO-52**  
200 mm

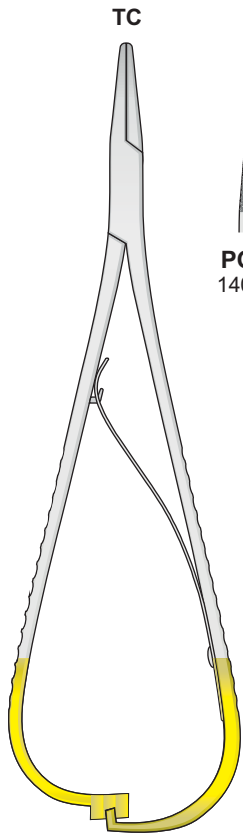
MATHIEU  
**PO-50/PO-52**



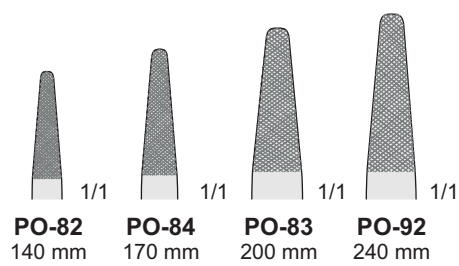
TC



MATHIEU  
**PO-66**  
200 mm



TC



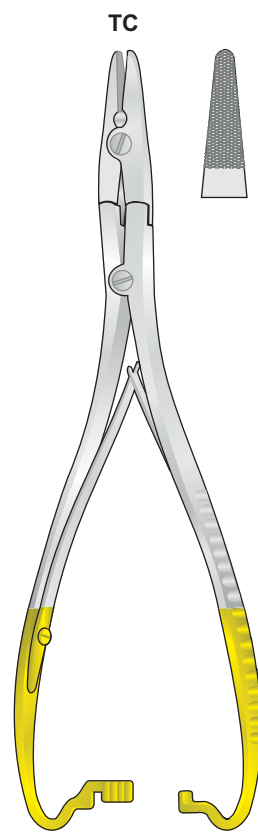
**PO-82**  
140 mm

**PO-84**  
170 mm

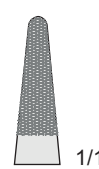
**PO-83**  
200 mm

**PO-92**  
240 mm

MATHIEU  
**PO-82/PO-92**



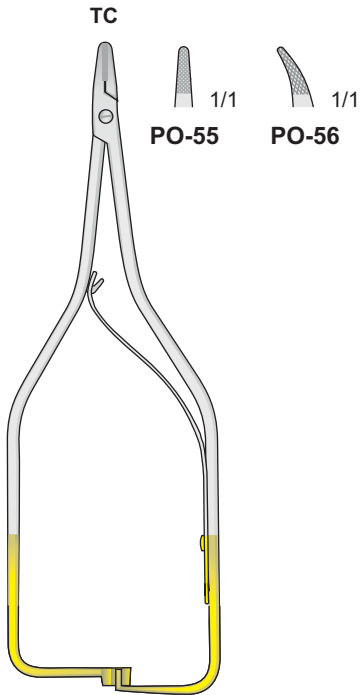
TC



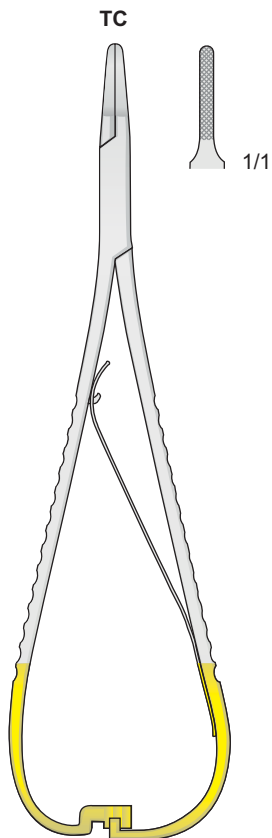
**PO-110**  
200 mm



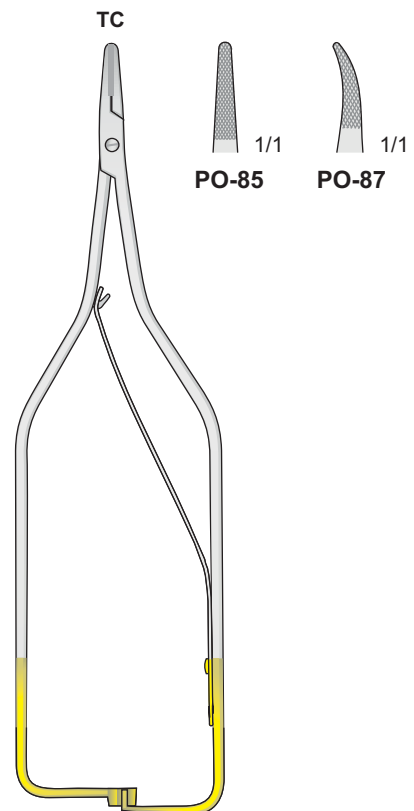
Portaghi con inserti al tungsteno - Needle Holders with tungsten-carbide inserts  
Nadelhalter mit Hartmetalleinlagen - Porte aiguilles avec plaquettes en carbure de tungstène  
Portaagujas con plaquitas de carburo de tungsteno



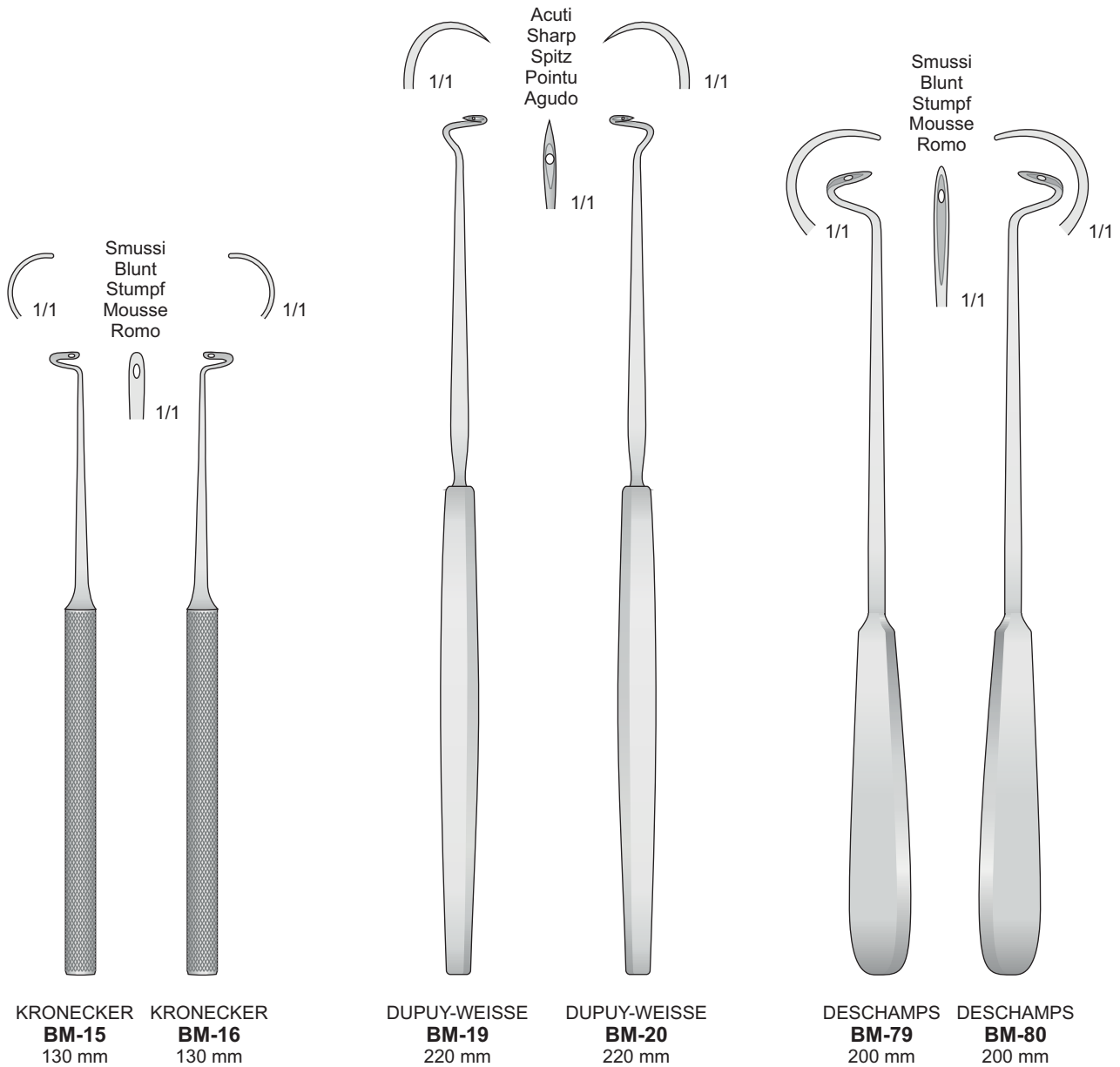
BOYNTON  
PO-55/PO-56  
120 mm



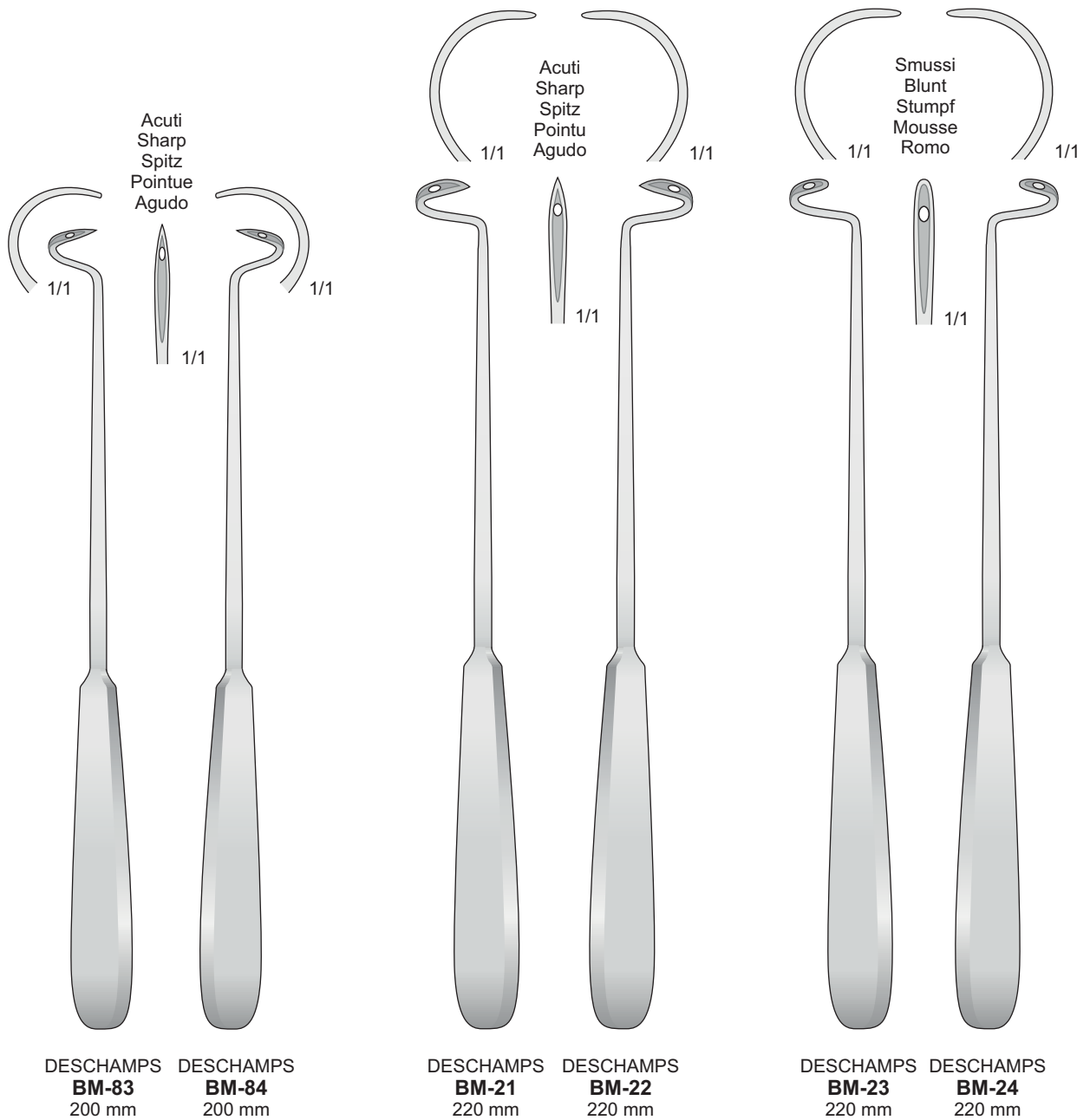
LICHTENBERG  
PO-86  
175 mm

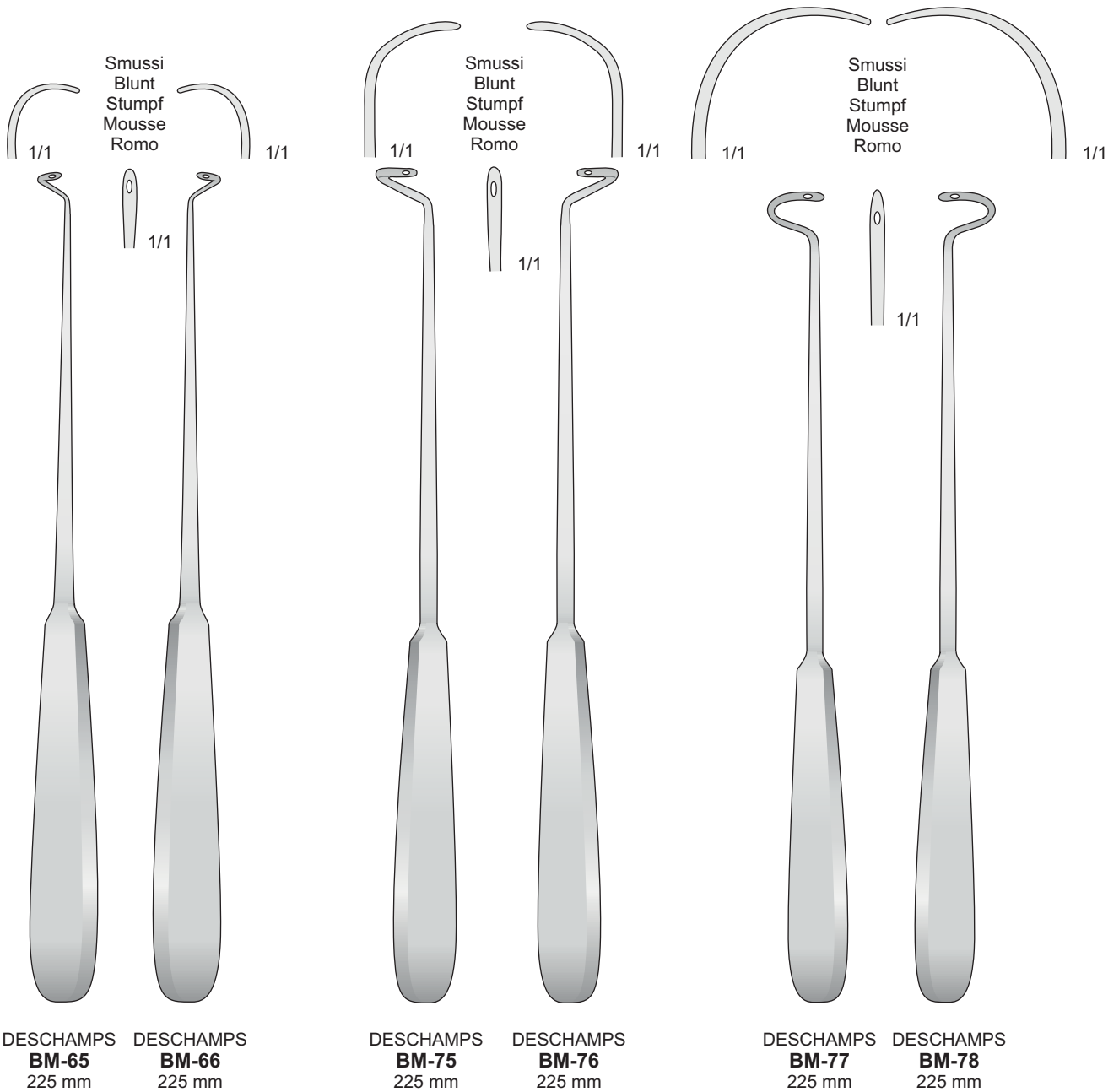


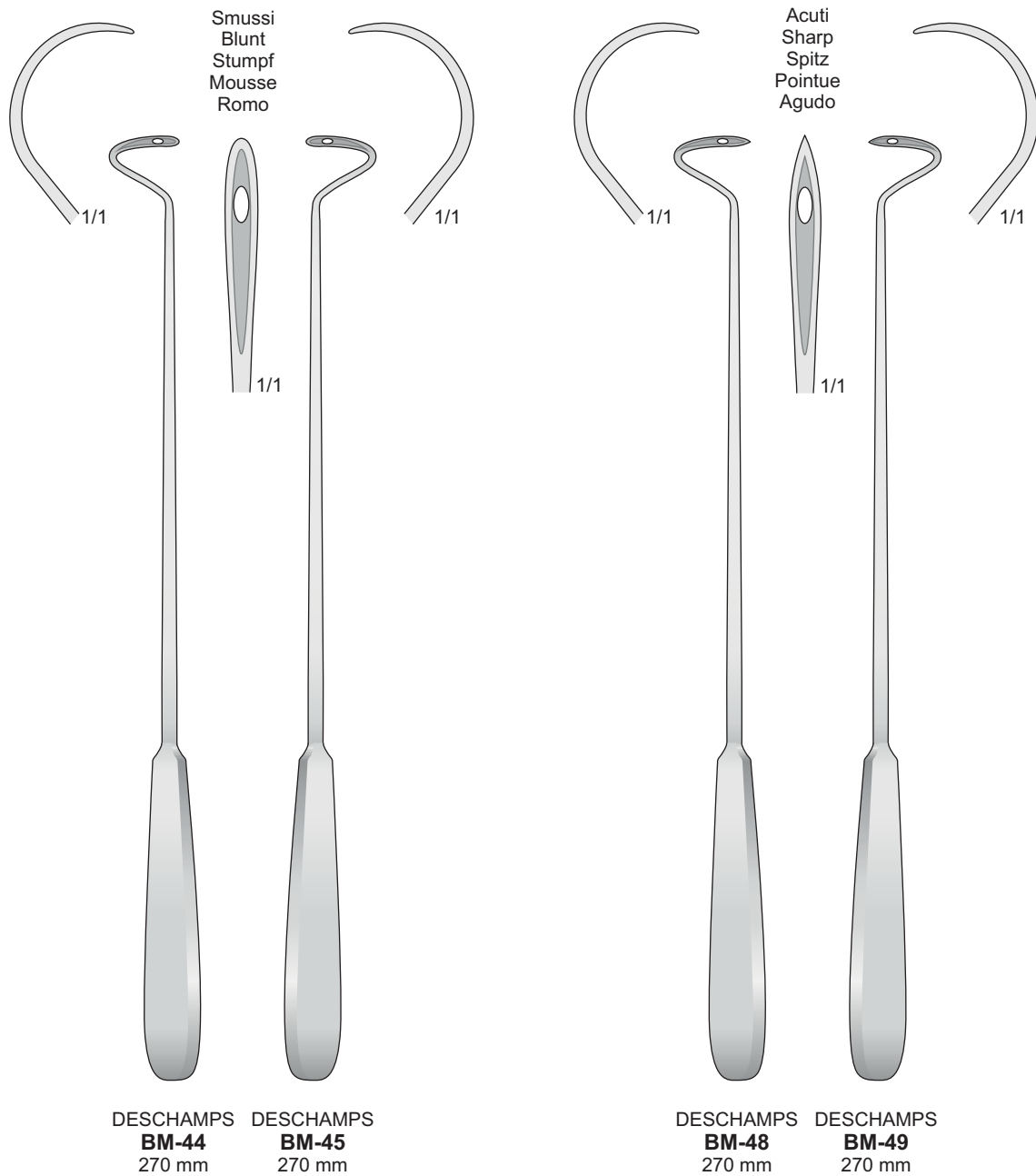
ARRUGA  
PO-85/PO-87  
160 mm

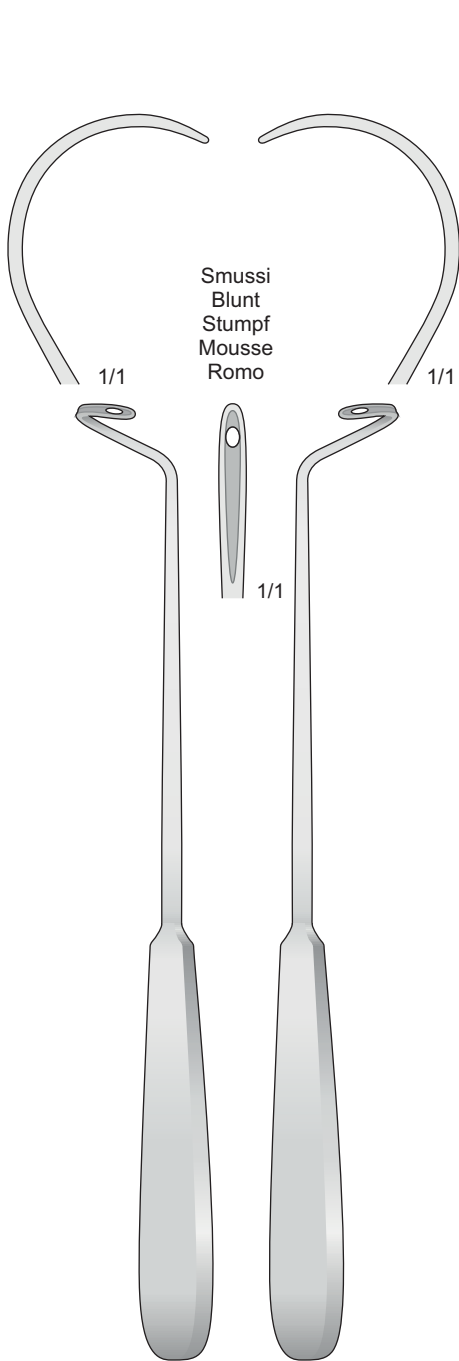




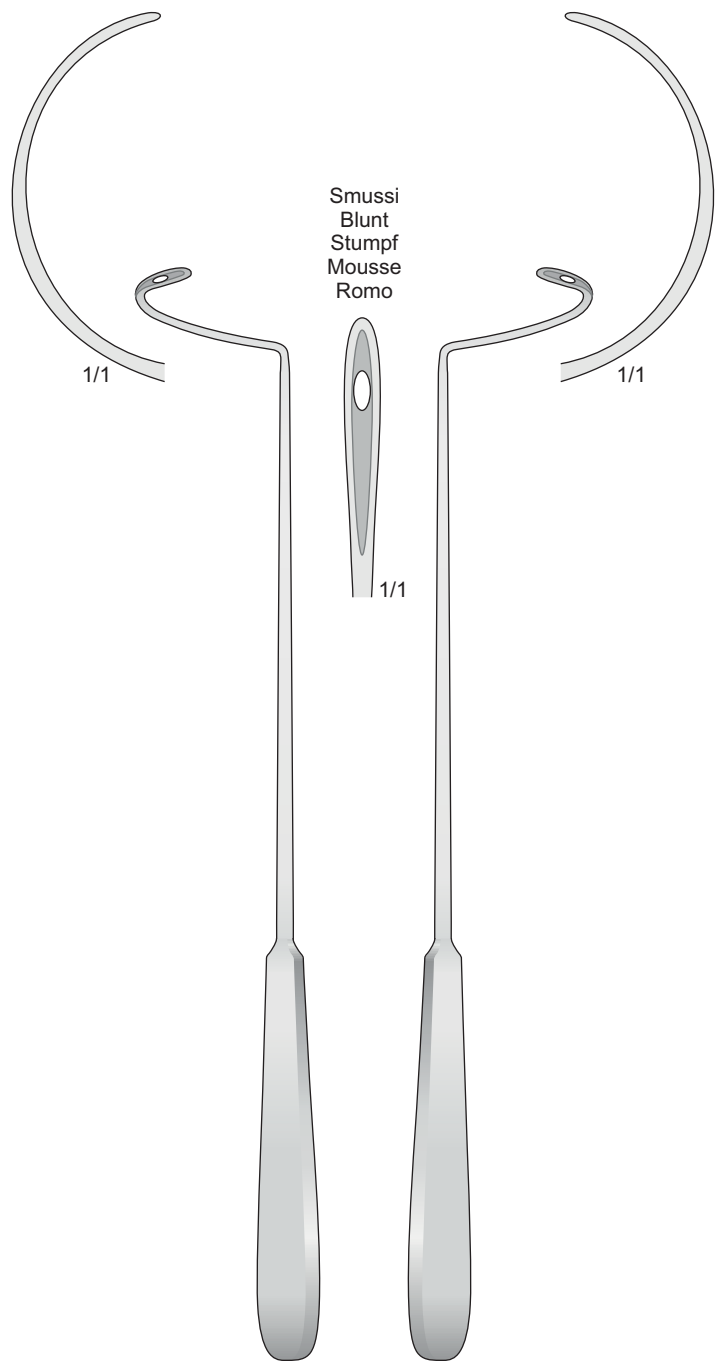




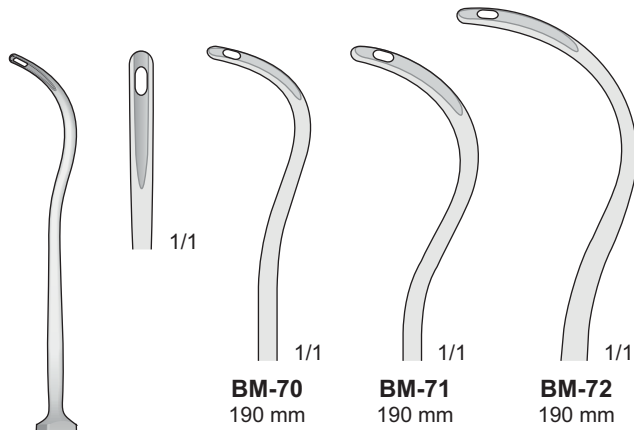




DESCHAMPS **BM-46** 240 mm  
DESCHAMPS **BM-47** 240 mm



DESCHAMPS **BM-52** 280 mm  
DESCHAMPS **BM-53** 280 mm

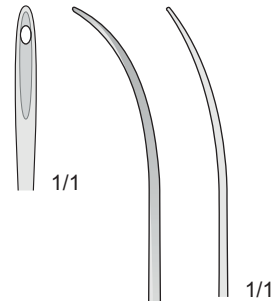


**BM-70**  
190 mm

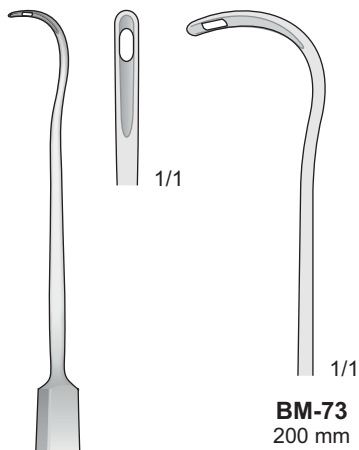
**BM-71**  
190 mm

**BM-72**  
190 mm

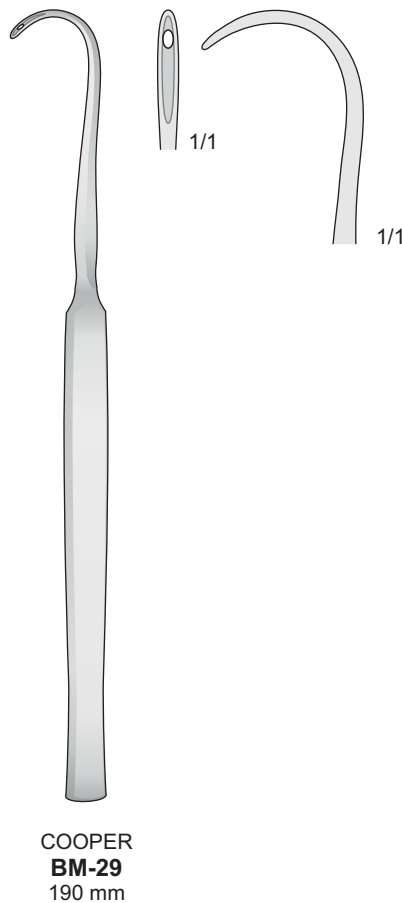
Malleabile  
Flexible  
Biegsam  
Souple  
Maleable



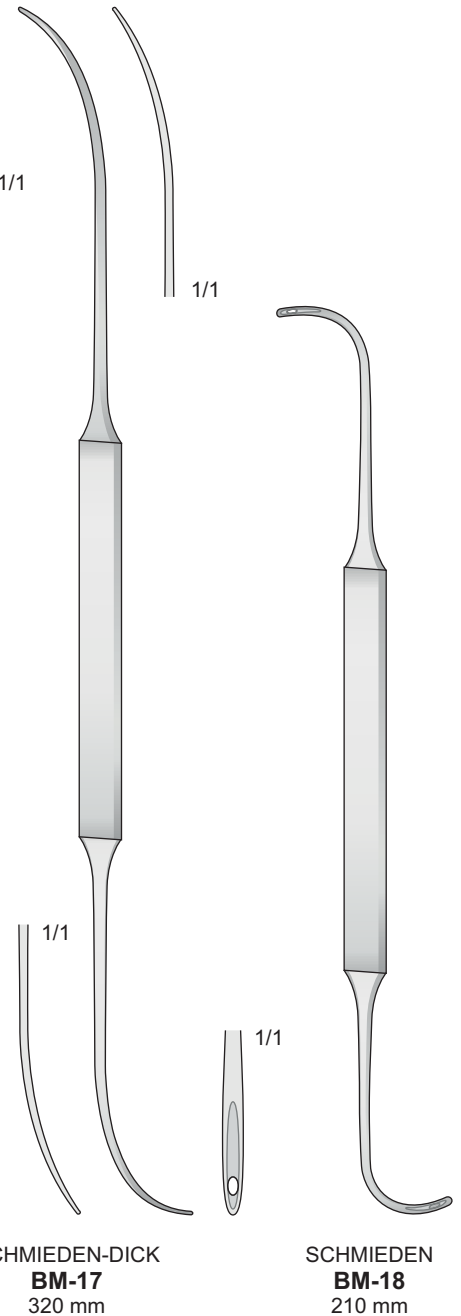
KOCHER  
**BM-70/BM-72**  
190 mm



COOPER  
**BM-73**  
200 mm

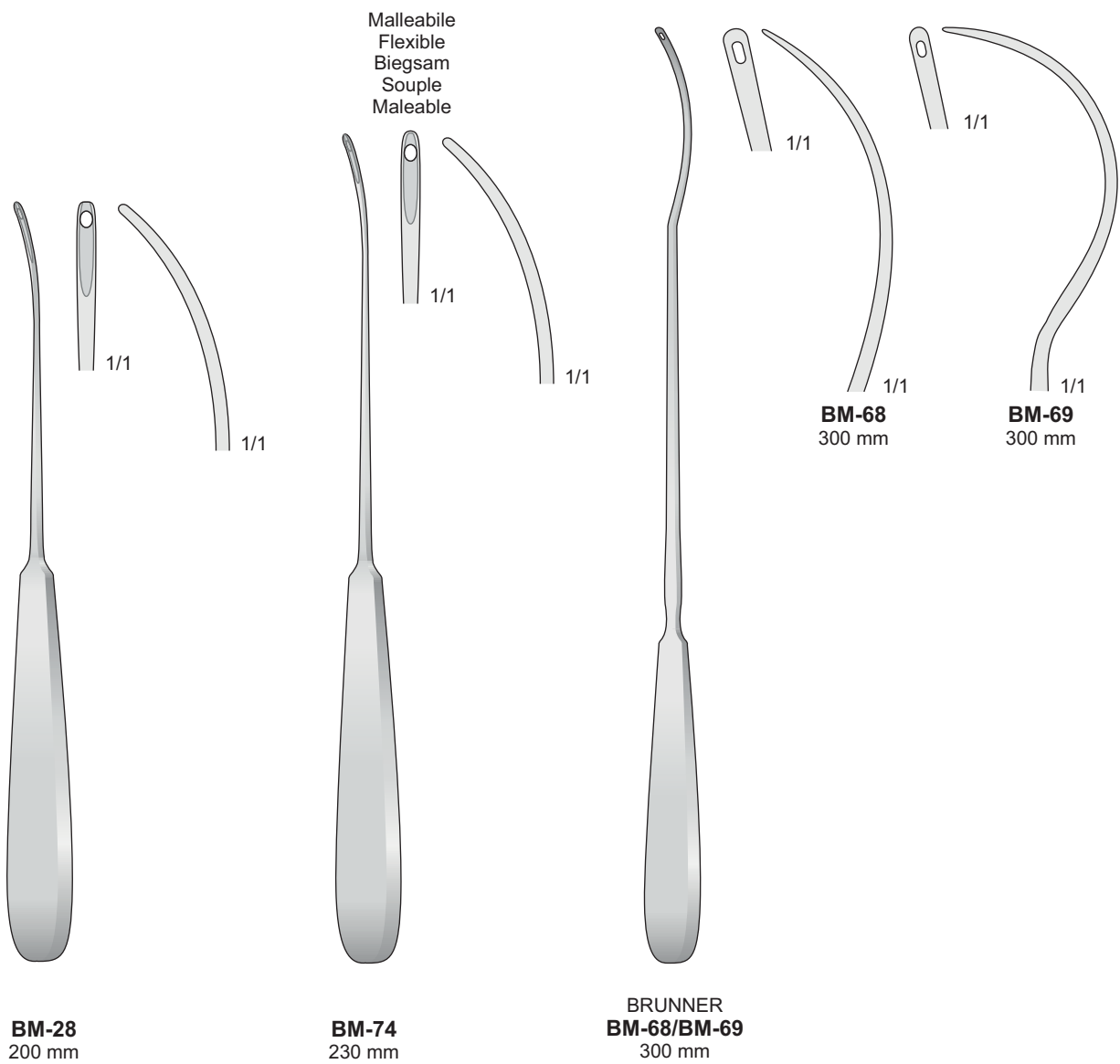


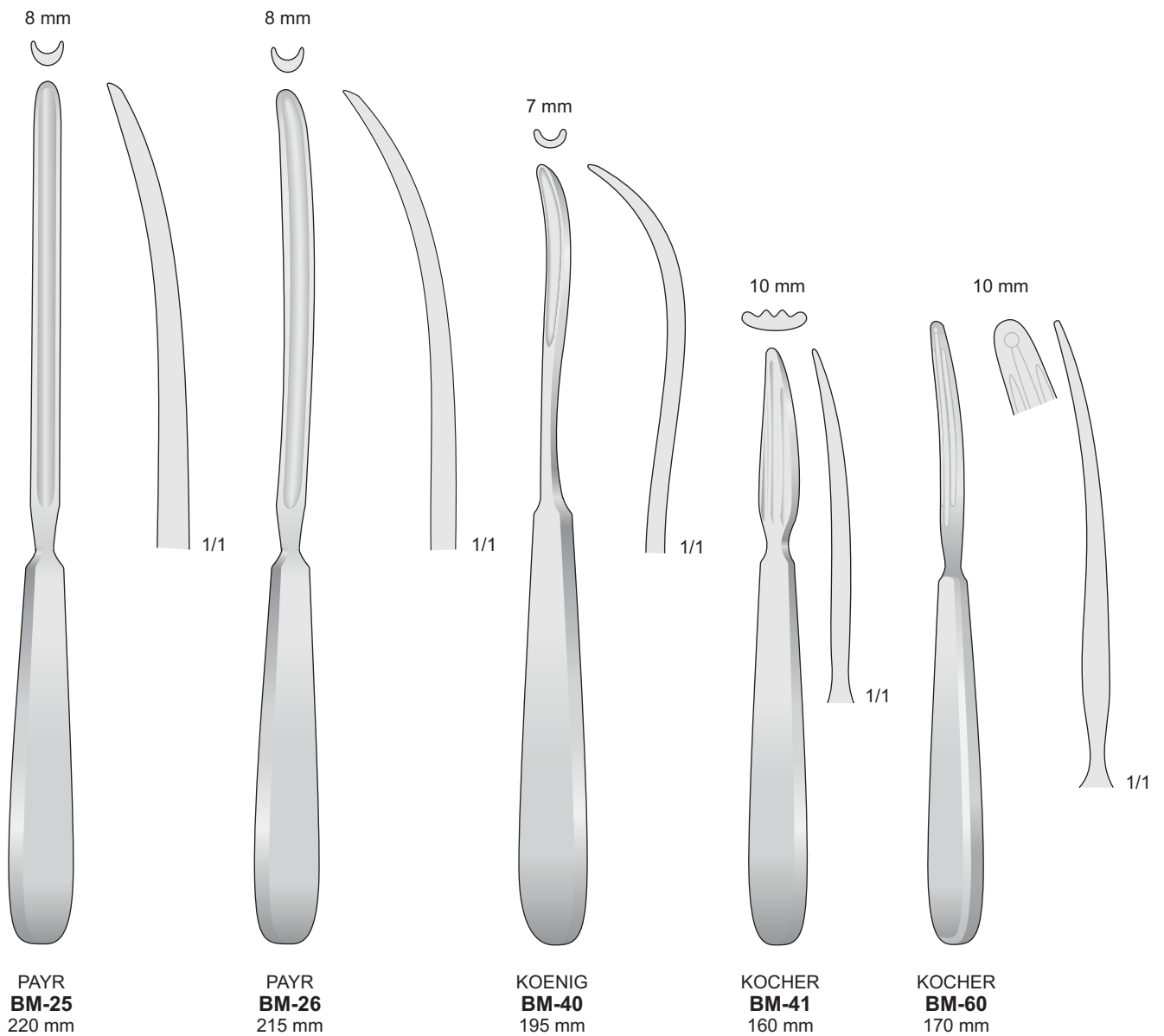
COOPER  
**BM-29**  
190 mm



SCHMIEDEN-DICK  
**BM-17**  
320 mm

SCHMIEDEN  
**BM-18**  
210 mm



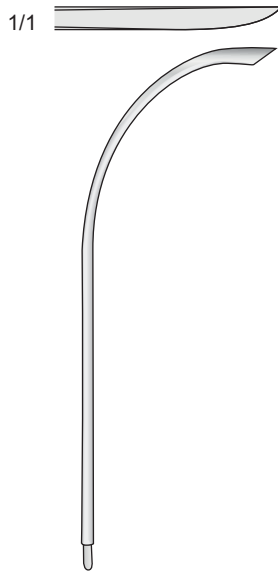




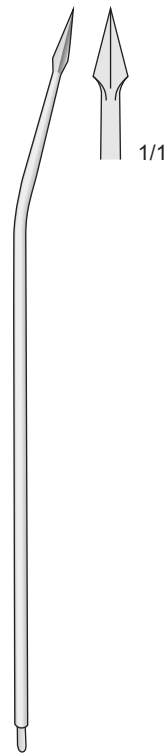
Char. 8	= 2,75 mm
Char 10	= 3,3 mm
Char 12	= 4 mm
Char 14	= 4,6 mm
Char 16	= 5,3 mm
Char 18	= 6 mm



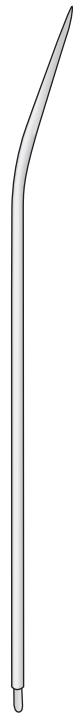
Punta a coltello  
Messerspitze gebogen  
Knife tip curved



Punta a coltello  
Messerspitze gebogen  
Knife tip curved



Punta a lancetta  
Lanzettenspitze gebogen  
Lancet tip curved



Punta Trocar  
Dreikanterspitze gebogen  
Trocar tip curved

Charr.

8	<b>BM-102</b>
10	<b>BM-103</b>
12	<b>BM-104</b>
14	<b>BM-105</b>
16	<b>BM-106</b>
18	<b>BM-107</b>

<b>BM-112</b>
<b>BM-113</b>
<b>BM-114</b>
<b>BM-115</b>
<b>BM-116</b>
<b>BM-117</b>

<b>BM-122</b>
<b>BM-123</b>
<b>BM-124</b>
<b>BM-125</b>
<b>BM-126</b>
<b>BM-127</b>

<b>BM-132</b>
<b>BM-133</b>
<b>BM-134</b>
<b>BM-135</b>
<b>BM-136</b>
<b>BM-137</b>





Pinze  
per agrafes

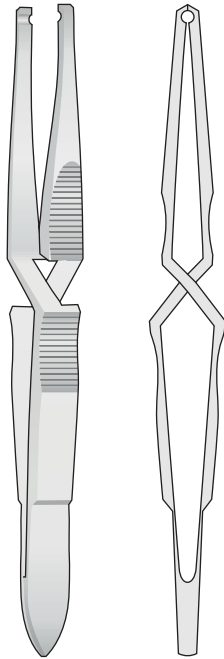
Clip applying  
forceps

Klammernanlegepinzetten

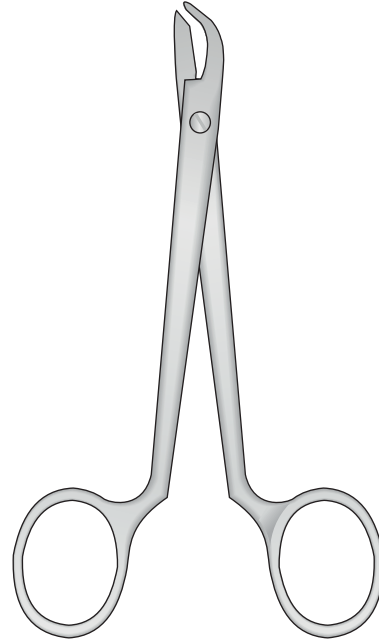
Pinces pour  
agrafes

Pinzas para  
agrafes

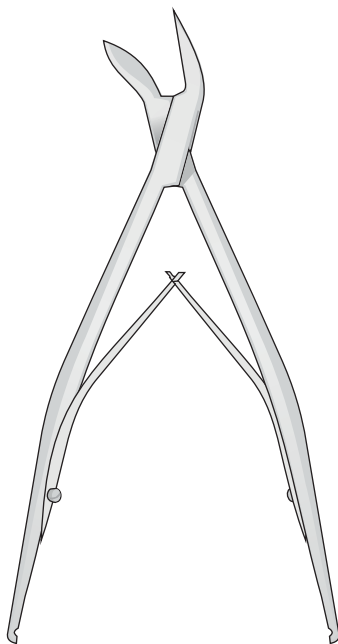
 1/1



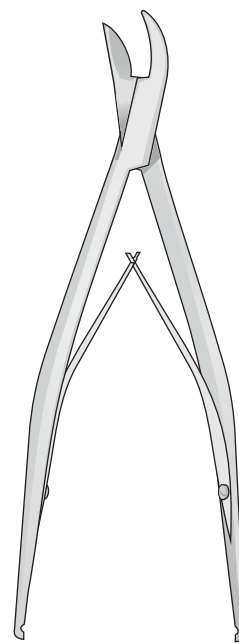
HEGENBARTH  
**BD-52**  
125 mm



COLLIN  
**BF-65**  
135 mm



MICHEL  
**BF-68**  
130 mm



MICHEL  
**BF-69**  
120 mm





8

Sonde, Specilli, Portacotone  
Probes, Directors, Cotton Applicators  
Sonden, Watterträger  
Stylets, Sondes, Porte coton  
Sondas, Estiletos, Portaalgodòn





Sonde bottonute

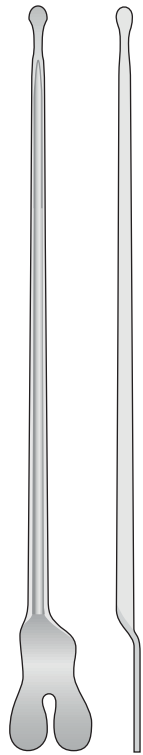
Probes

Sonden

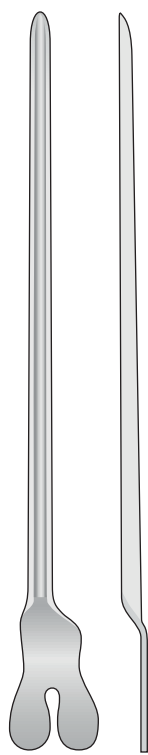
Sondes

Estiletos

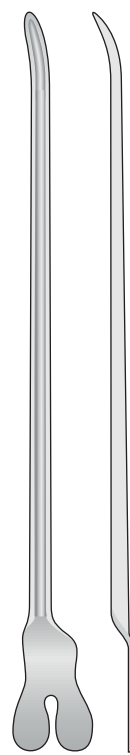
Hohlsonde



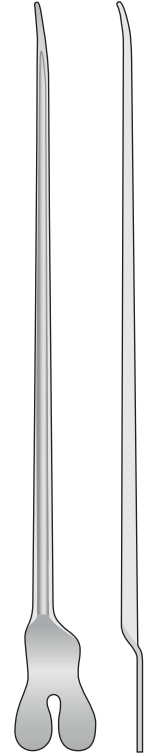
**PF-54** 145 mm  
**PF-55** 160 mm  
**PF-19** 180 mm  
**PF-56** 200 mm



**PF-53** 130 mm  
**PF-57** 145 mm  
**PF-58** 160 mm  
**PF-59** 180 mm  
**PF-18** 200 mm



**DOYEN**  
**PF-24**  
145 mm

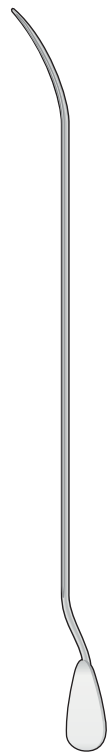


**NELATON**  
**PF-17**  
160 mm

Sonde per fistole - Fistula probes - Fistelsonden - Sondes pour fistulas - Sondas para fistulas



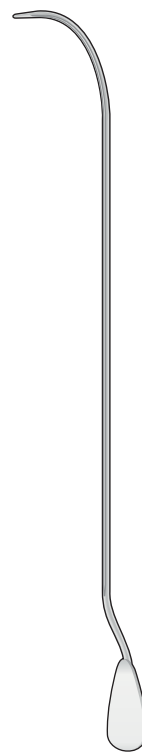
**LOCHART**  
**PF-80**  
170 mm



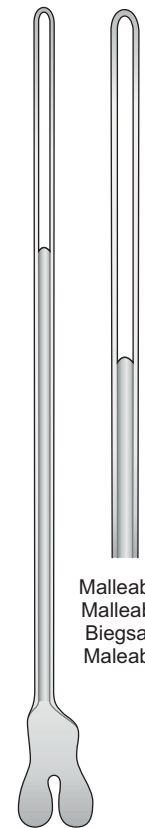
**LOCHART**  
**PF-81**  
170 mm



**LOCHART**  
**PF-82**  
170 mm



**LOCHART**  
**PF-83**  
170 mm



**LOCHART**  
**PF-85**  
190 mm

1/1  
Malleabile  
Malleable  
Bięgsam  
Maleable



Sonde bottonute

Probes

Sonden

Sondes

Estiletos

Ø 1 mm



**PF-20** 145 mm  
**PF-21** 160 mm

Ø 1,5 mm



**PF-32** 130 mm  
**PF-22** 145 mm  
**PF-25** 160 mm  
**PF-26** 200 mm

Ø 2 mm



**PF-27** 145 mm  
**PF-23** 160 mm  
**PF-28** 200 mm  
**PF-44** 250 mm

Ø 2 mm



**PF-36** 130 mm  
**PF-15** 145 mm  
**PF-29** 160 mm  
**PF-38** 200 mm

Ø 1,5 mm



**PF-7**  
145 mm

Ø 1,0 mm



STACKE  
**PF-14**  
110 mm



BOWMAN  
**PF-30** 00/0  
**PF-31** 1/2  
**PF-33** 3/4  
**PF-34** 5/6  
**PF-35** 7/8  
**PF-37** 6/7



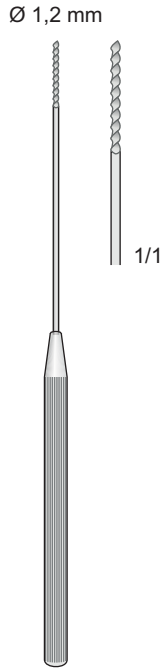
Porta cotone

Cotton applicators

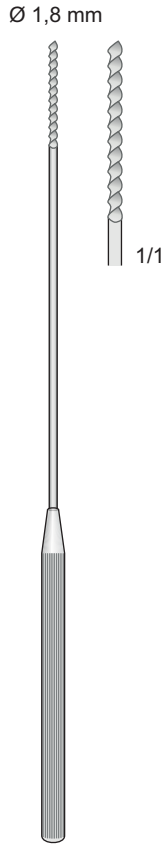
Watteträger

Porte cotons

Portaalgodòn



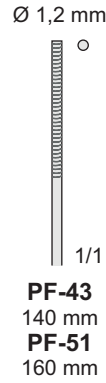
UNIVERSAL  
PF-48 120 mm  
PF-40 140 mm  
PF-50 160 mm



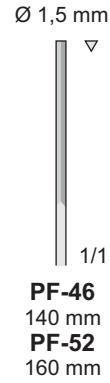
UNIVERSAL  
PF-62 120 mm  
PF-63 140 mm  
PF-64 160 mm  
PF-41 180 mm



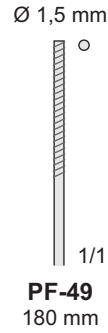
MOD. MARTIN  
PF-43/PF-52



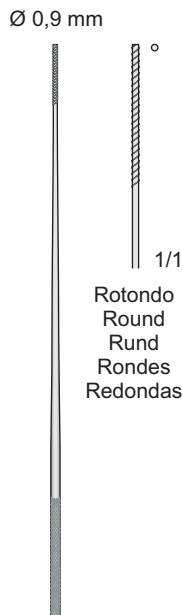
Rotondo  
Round  
Rund  
Rondes  
Redondas



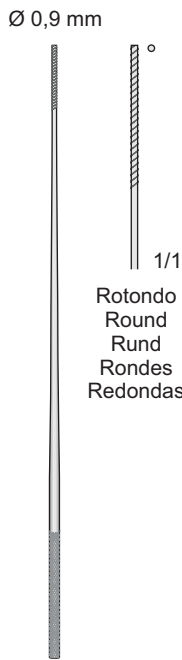
Triangolare  
Triangular  
Dreikant  
Triangulaires  
Triangulares



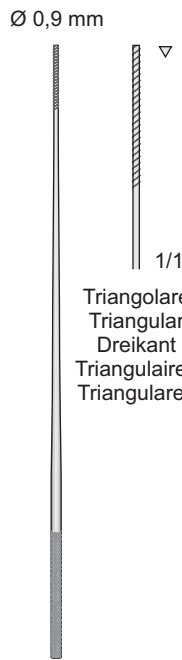
Rotondo  
Round  
Rund  
Rondes  
Redondas



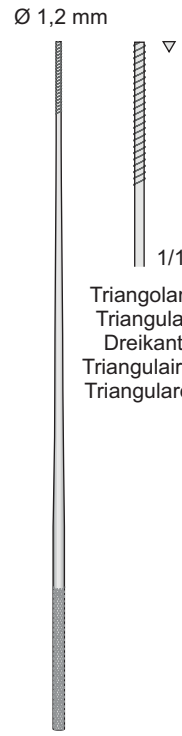
FARRELL  
PF-10 120 mm



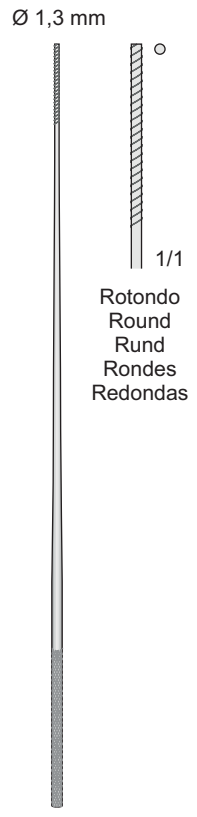
FARRELL  
PF-13 140 mm  
PF-66 160 mm  
PF-67 180 mm



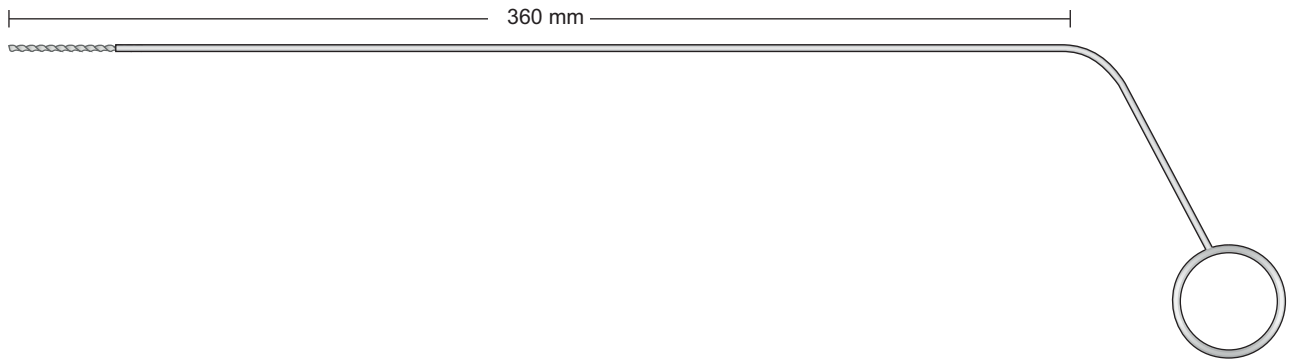
FARRELL  
PF-68 140 mm  
PF-69 160 mm



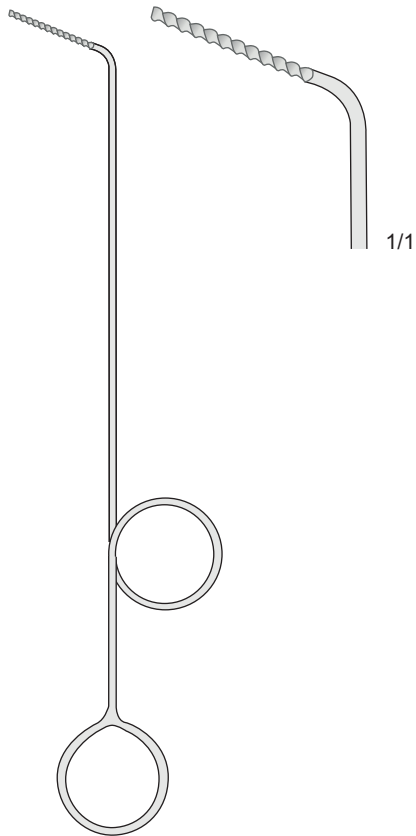
FARRELL  
PF-39 180 mm



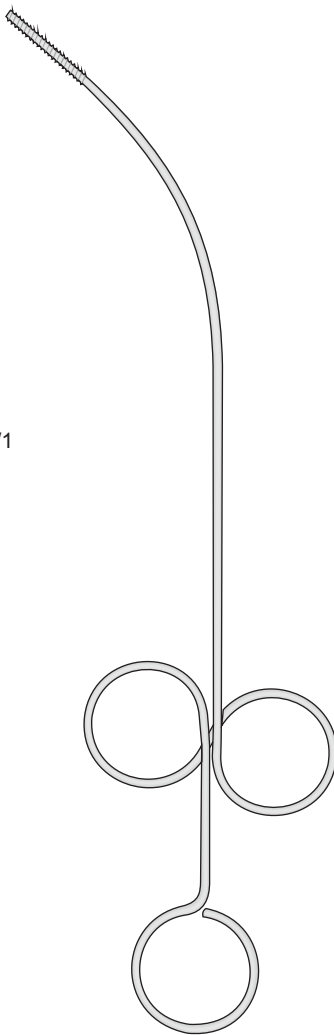
FARRELL  
PF-42 230 mm



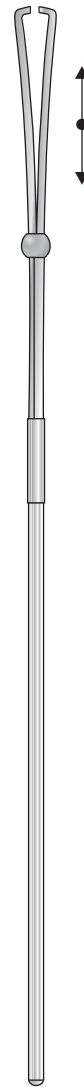
**PF-88**  
400 mm



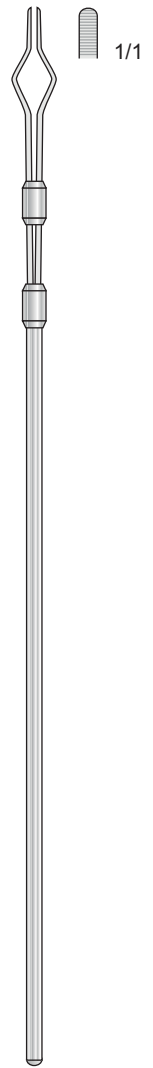
**HARTMANN**  
**PF-73** - Ø 2,3 mm  
220 mm



**FEIN**  
**PF-65**  
250 mm

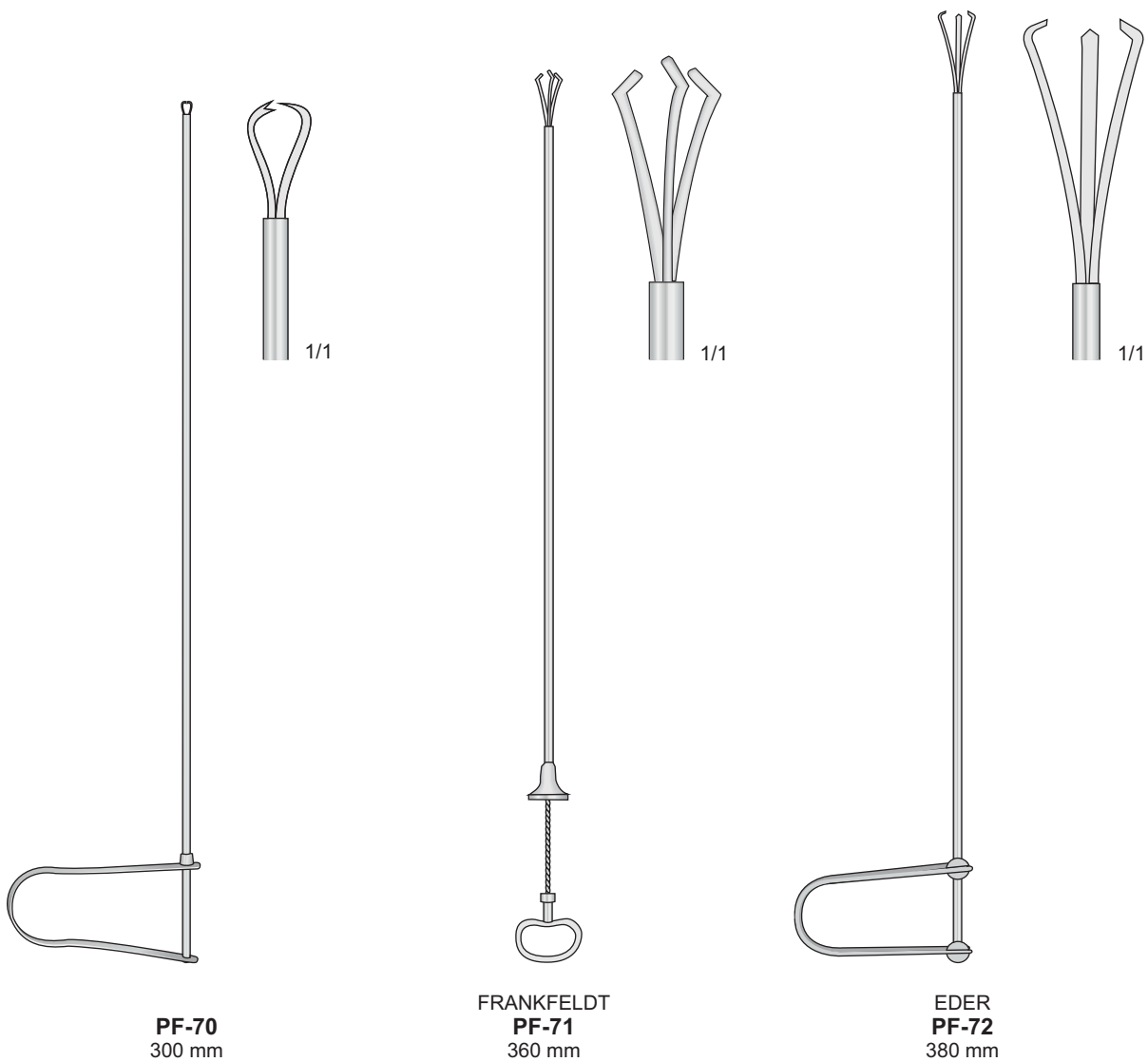


**HEILDEBERG**  
**PF-60**  
180 mm



**HEILDEBERG**  
**PF-61**  
170 mm









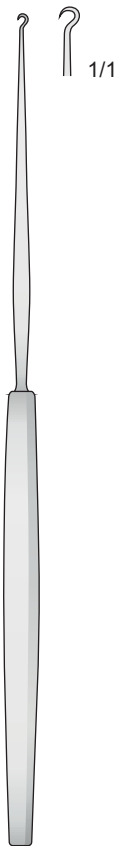
9

Divaricatori, Chirurgia Toracica  
Retractors  
Wundhaken  
Ecarteurs  
Separadores

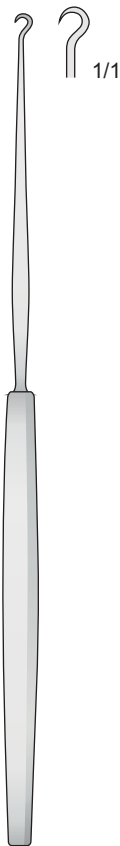




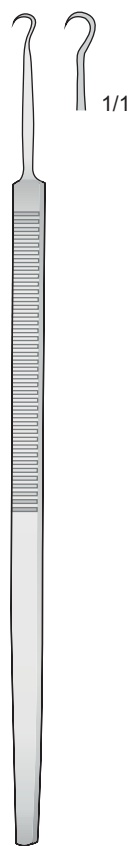
Uncini cutanei - Cutaneous hook - Hauthäkchen - Erignes cutanées - Ganchos cutáneos



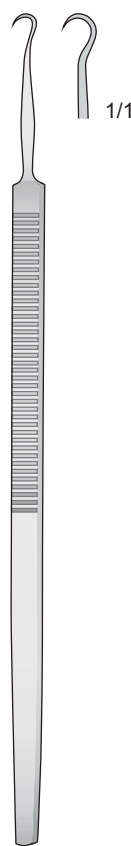
GILLIES  
**BT-15**  
180 mm



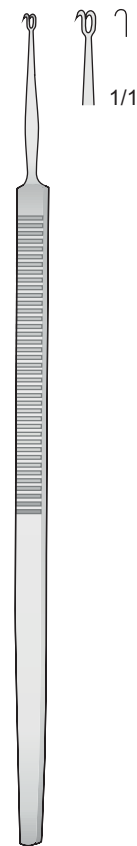
GILLIES  
**BT-16**  
180 mm



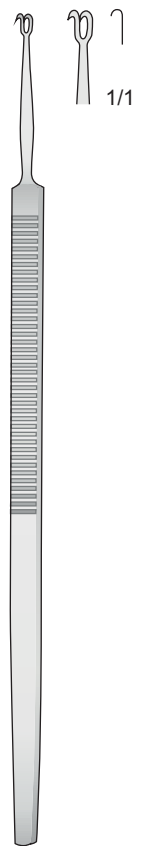
**BT-207**  
160 mm



**BT-208**  
160 mm



GUTHRIE  
**BT-203**  
160 mm



GUTHRIE  
**BT-204**  
160 mm



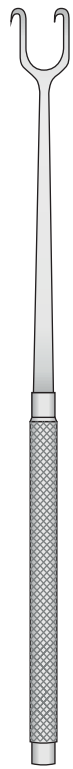
Divaricatori

Retractors

Wundhaken

Ecarteurs

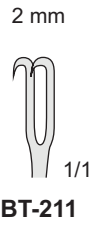
Separadores



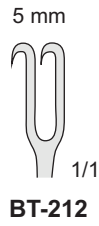
JOSEPH  
BT-210/BT-214  
160 mm



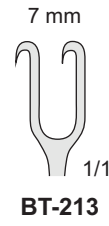
BT-210



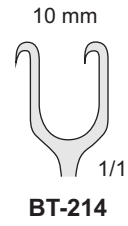
2 mm  
BT-211



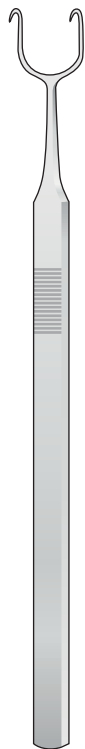
5 mm  
BT-212



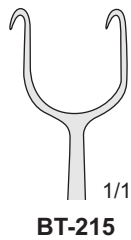
7 mm  
BT-213



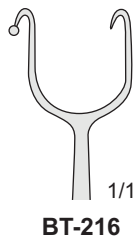
10 mm  
BT-214



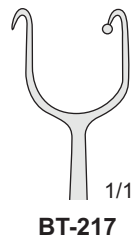
COTTLE  
BT-215/BT-217  
150 mm



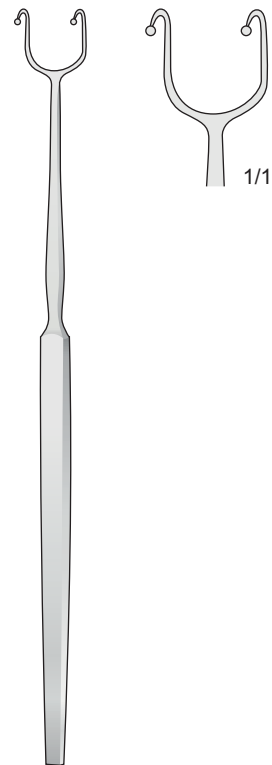
BT-215



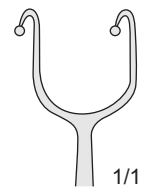
BT-216



BT-217



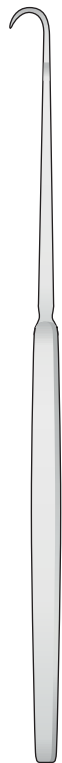
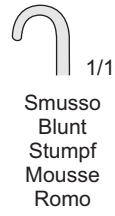
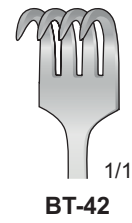
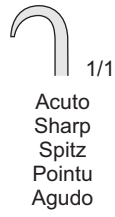
FOMON  
BT-218  
160 mm



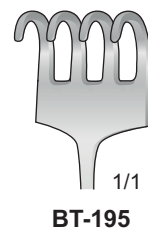
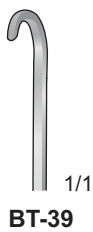
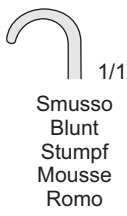
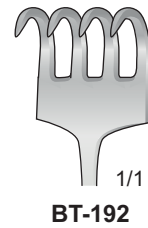
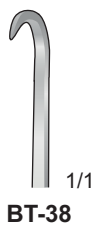
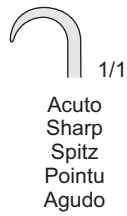
1/1



**BT-40/BT-46**  
160 mm



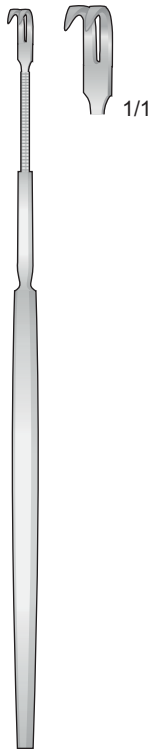
**BT-38/BT-195**  
160 mm



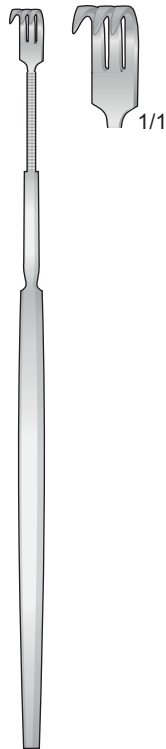


Divaricatori delicati flessibili-acuti  
Feine wundhaken flexibel-spitz  
Delicate retractors flexible-sharp  
Separadores finos flexibles-agudas

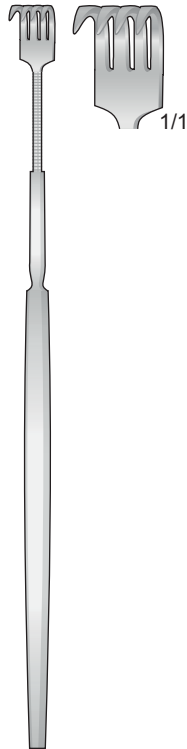
Divaricatori delicati flessibili-smussi  
Feine wundhaken flexibel-stumpf  
Delicate retractors flexible-blunt  
Separadores finos flexibles-romas



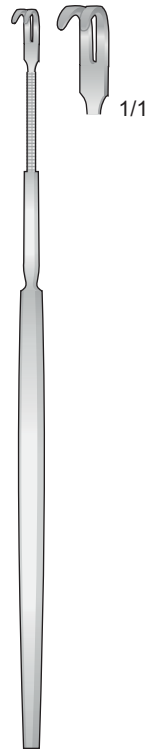
**BT-50**  
150 mm



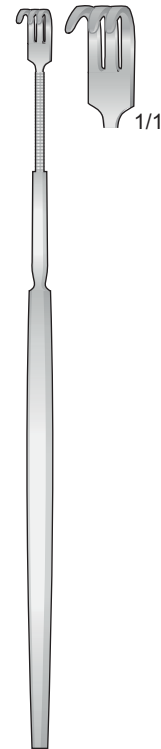
**BT-51**  
150 mm



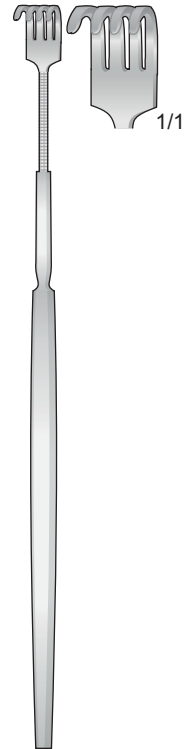
**BT-52**  
150 mm



**BT-54**  
150 mm

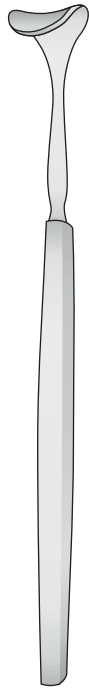


**BT-55**  
150 mm



**BT-56**  
150 mm

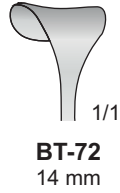




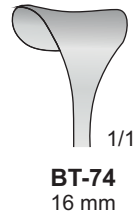
DESMARRES  
BT-70/BT-79  
140 mm



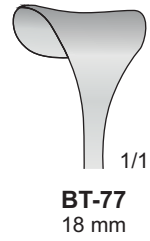
BT-70  
10 mm



BT-72  
14 mm



BT-74  
16 mm



BT-77  
18 mm



BT-71  
12 mm



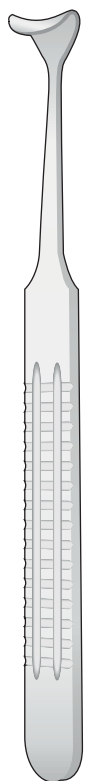
BT-73  
14 mm



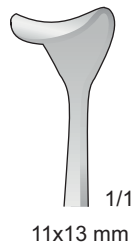
BT-75  
16 mm



BT-79  
18 mm



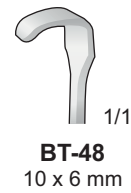
DESMARRES  
BT-28  
160 mm



11x13 mm



SENN GREEN  
BT-48/BT-49  
160 mm



BT-48  
10 x 6 mm



BT-49  
20 x 6 mm



Divaricatori

Retractors

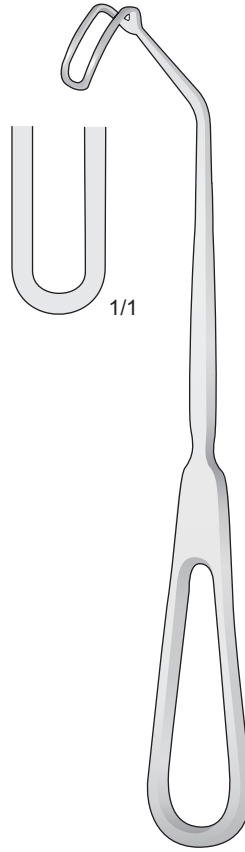
Wundhaken

Ecarteurs

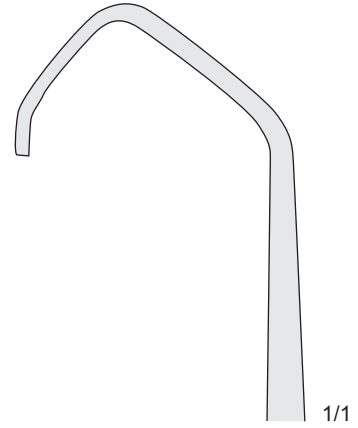
Separadores



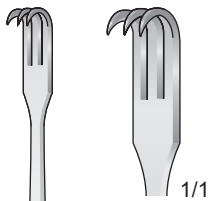
LAHEY  
BT-109  
195 mm



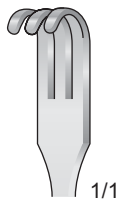
CUSHING  
BT-29  
200 mm



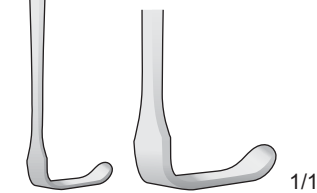
1/1



BT-18



BT-19

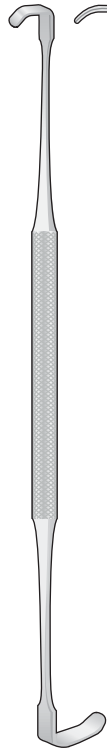


SENN-MILLER  
BT-18/BT-19  
160 mm

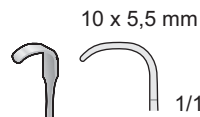


8 x 3 mm

1/1

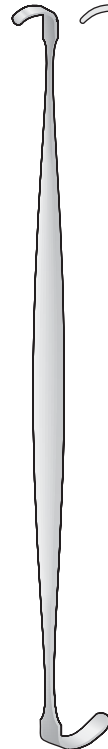


RAGNELL  
BT-27  
140 mm



10 x 5,5 mm

1/1



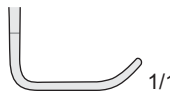
RAGNELL-DAVIS  
BT-26  
140 mm

15 x 5 mm

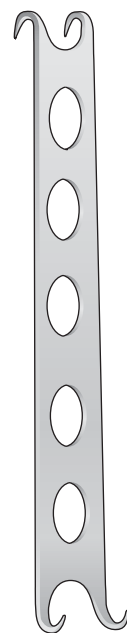


1/1

17 x 5,5 mm



1/1



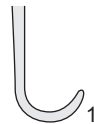
CONVERSE  
BT-22  
120 mm



7 x 12 mm

1/1

8 x 12 mm



1/1



Divaricatori

Retractors

Wundhaken

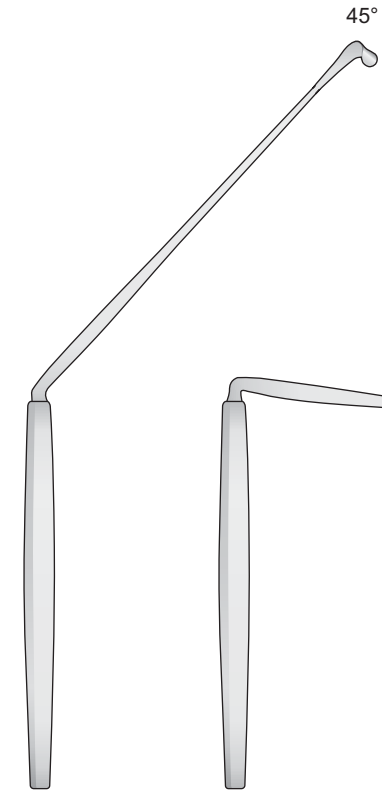
Ecarteurs

Separadores

Dritto



LOVE  
DO-56  
210 mm



LOVE  
DO-57

LOVE  
DO-58

45°

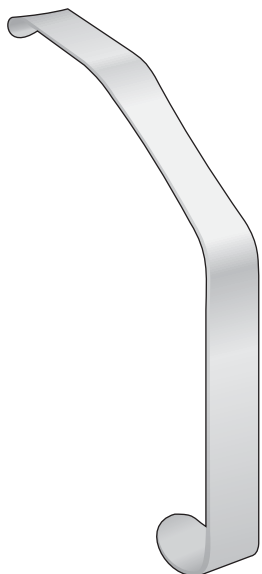
90°



LOVE  
DO-174  
210 mm



1/1



LOVE  
DO-213 - 18 mm  
DO-214 - 20 mm  
DO-215 - 22 mm  
150 mm



BT-296  
1/1

BT-297  
1/1

CUSHING  
BT-296/BT-297  
190 mm



BT-298  
1/1



BT-299  
1/1

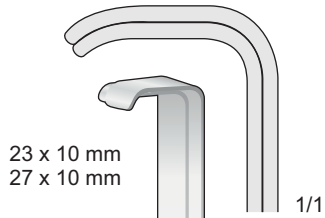
CUSHING  
BT-298/BT-299  
280 mm



LANGE  
KO-60  
220 mm

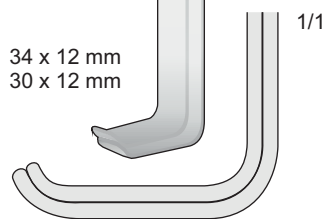


1/1



23 x 10 mm  
27 x 10 mm

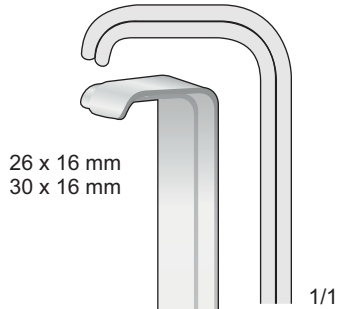
1/1



34 x 12 mm  
30 x 12 mm

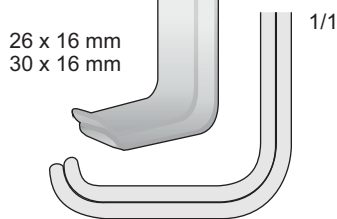
1/1

FARABEU  
**BT-20**  
120 mm



26 x 16 mm  
30 x 16 mm

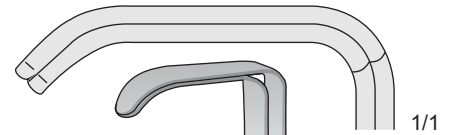
1/1



26 x 16 mm  
30 x 16 mm

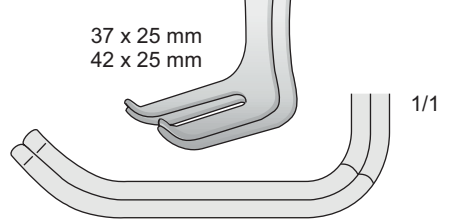
1/1

FARABEU  
**BT-25**  
150 mm



47 x 13 mm  
41 x 13 mm

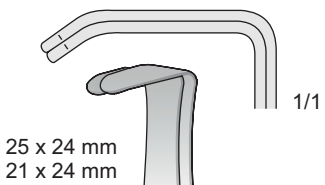
1/1



37 x 25 mm  
42 x 25 mm

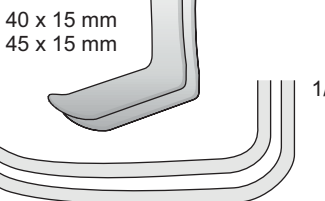
1/1

MATHIEU  
**BT-294**  
200 mm



25 x 24 mm  
21 x 24 mm

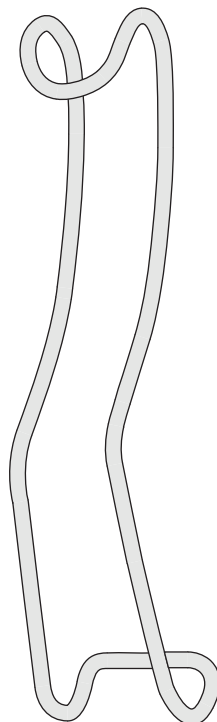
1/1



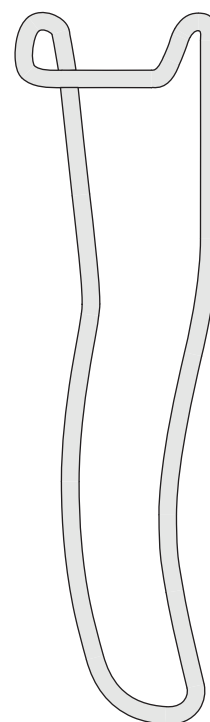
40 x 15 mm  
45 x 15 mm

1/1

PARKER-LANGENBECK  
**BT-291**  
210 mm



STERNBERG  
**OM-50**  
160 mm



STERNBERG  
**OM-52**  
160 mm



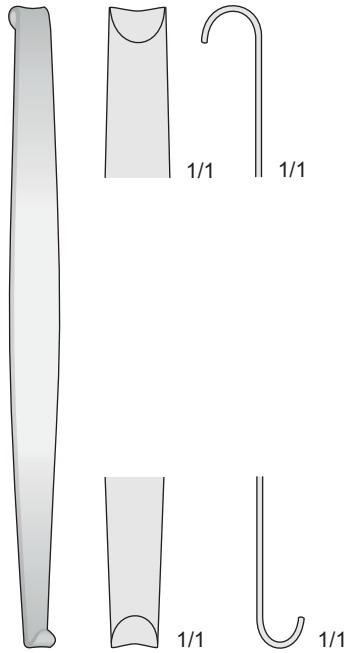
Divaricatori

Retractors

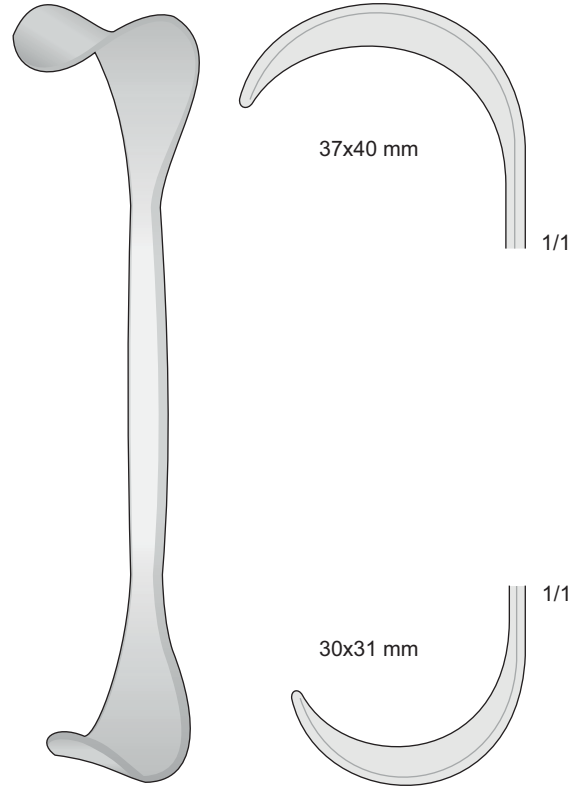
Wundhaken

Ecarteurs

Separadores



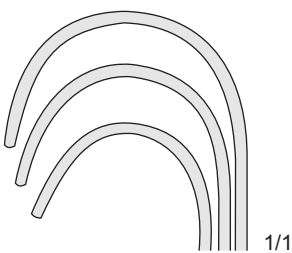
MINI-ROUX  
BT-282  
150 mm



GOELET  
BT-83  
190 mm

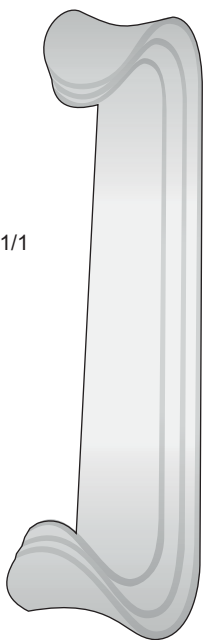
**BT-283**  
Set completo  
Set complete  
Komplettsset  
Set complet  
Set completo

29 mm  
26 mm  
22 mm

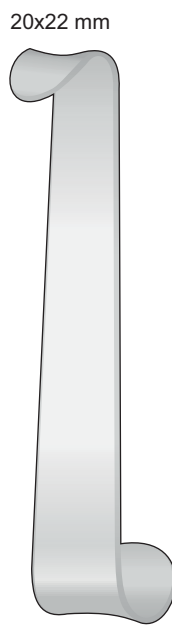


**BT-284** - 20x22 mm  
25x28 mm  
**BT-285** - 23x26 mm  
29x38 mm  
**BT-286** - 29x29 mm  
34x44 mm

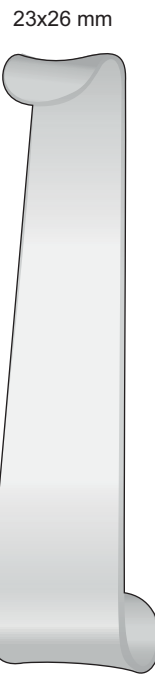
28 mm  
38 mm  
44 mm



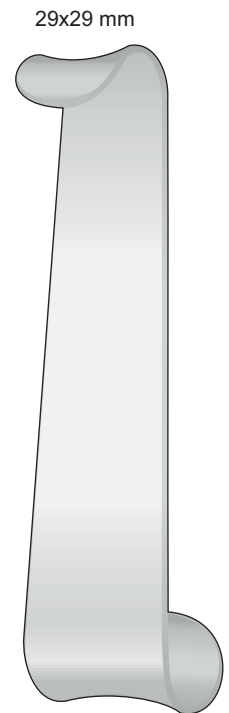
ROUX  
BT-284/BT-286  
165 mm



25x28 mm  
ROUX-MAGNUS  
BT-287  
150 mm



23x26 mm  
ROUX-MAGNUS  
BT-288  
160 mm



29x29 mm  
ROUX-MAGNUS  
BT-289  
170 mm



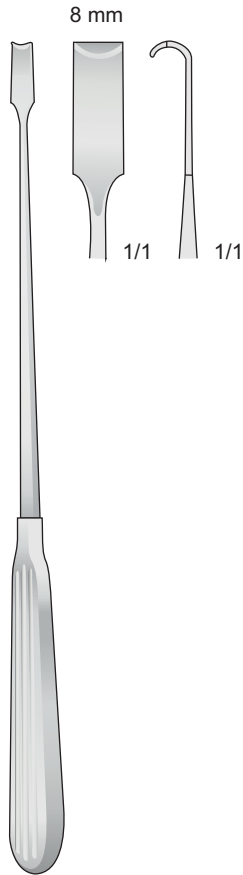
Divaricatori

Retractors

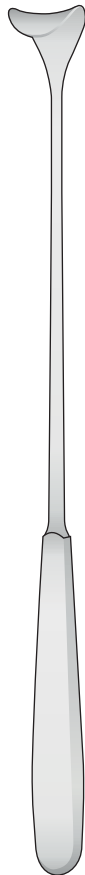
Wundhaken

Ecarteurs

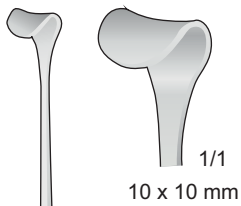
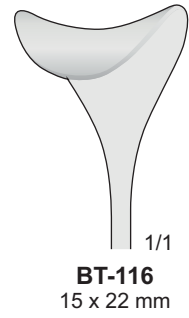
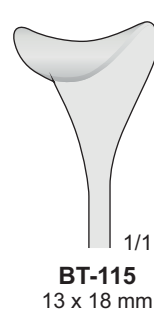
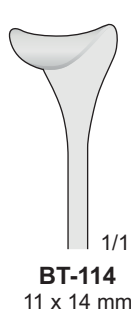
Separadores



SCOVILLE  
**BT-312**  
230 mm



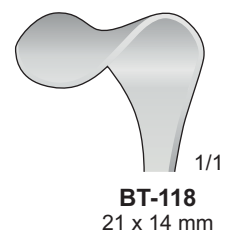
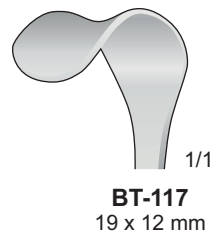
CUSHING  
**BT-114/BT-116**  
250 mm

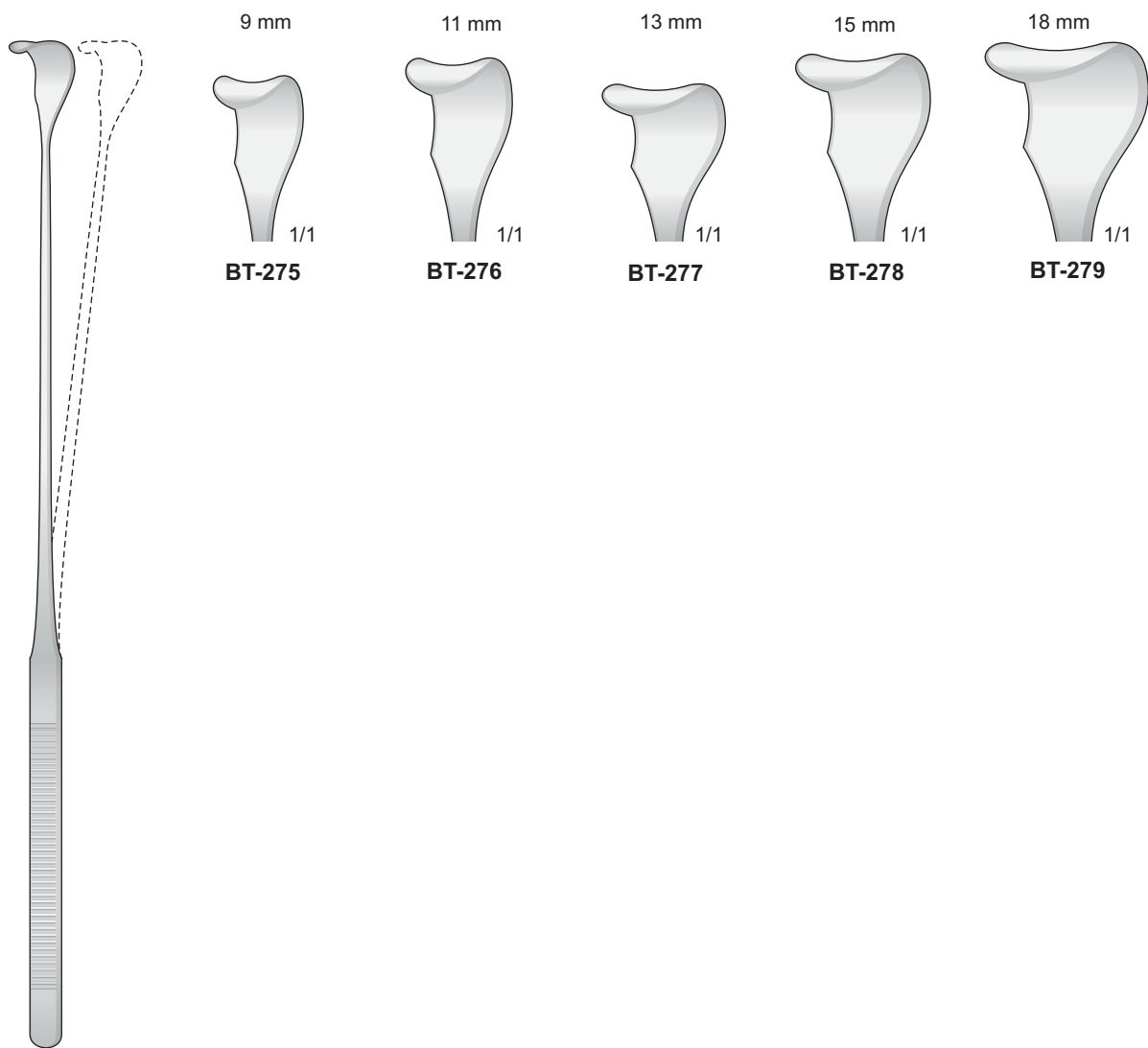


CUSHING-KOCHER  
**BT-113**  
180 mm

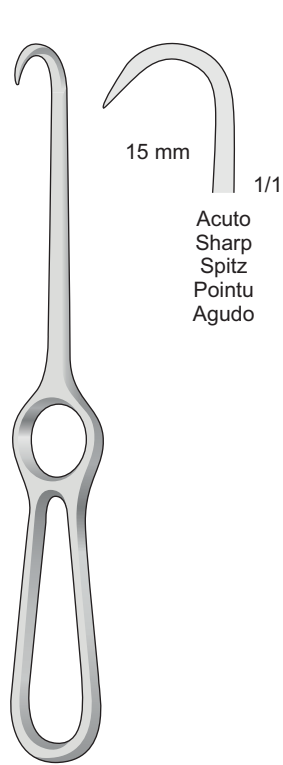


KOCHER  
**BT-117/BT-118**  
205 mm

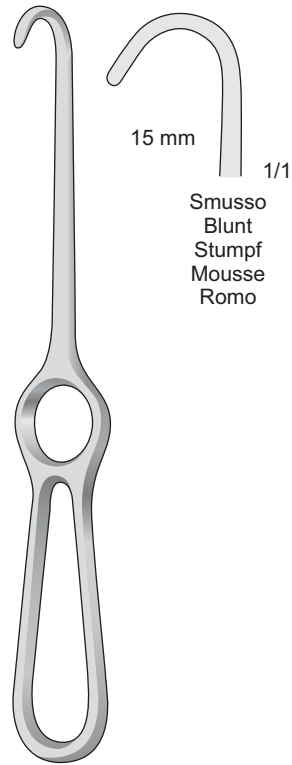




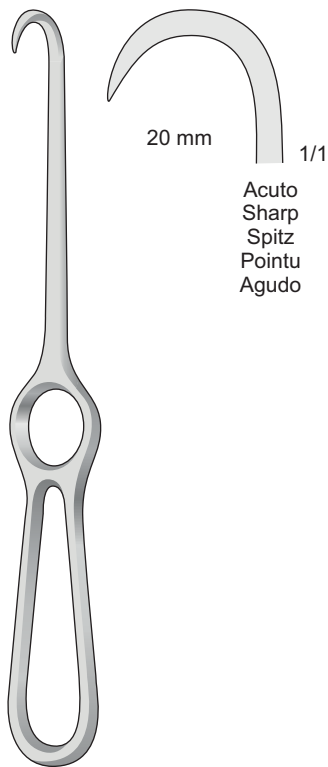
GIL-VERNET  
BT-275/BT-279  
280 mm



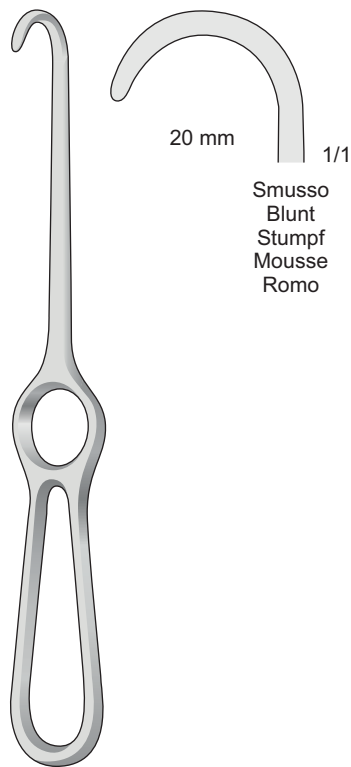
KOCHER  
**BT-139**  
205 mm



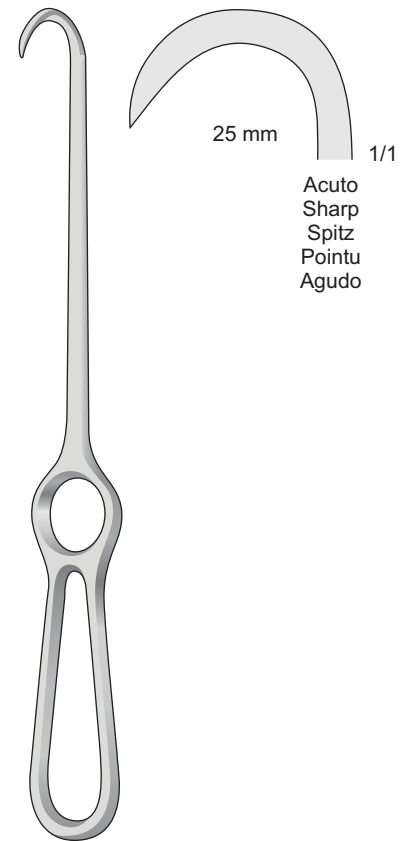
KOCHER  
**BT-140**  
220 mm



VOLKMANN  
**BT-126**  
220 mm

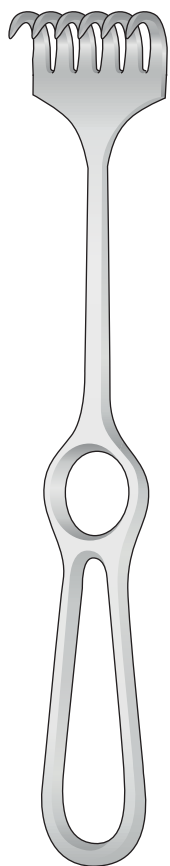


VOLKMANN  
**BT-127**  
220 mm



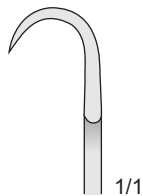
**BT-128**  
245 mm





VOLKMANN  
BT-101/BT-108  
220 mm

Acuto  
Sharp  
Spitz  
Pointu  
Agudo



1/1



**BT-101**  
9 x 8 mm



**BT-103**  
9 x 13 mm

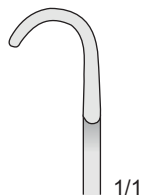


**BT-105**  
9 x 19 mm



**BT-107**  
9 x 29 mm

Smusso  
Blunt  
Stumpf  
Mousse  
Romo



1/1



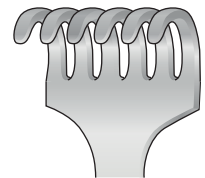
**BT-102**  
9 x 8 mm



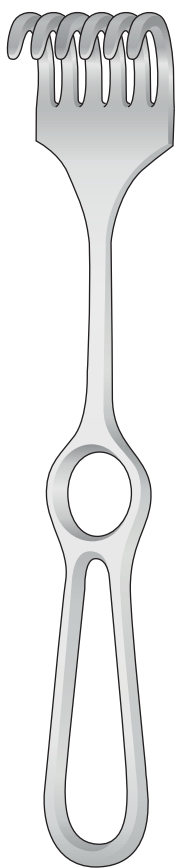
**BT-104**  
9 x 13 mm



**BT-106**  
9 x 19 mm

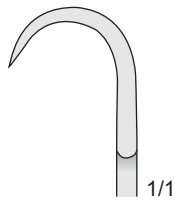


**BT-108**  
9 x 29 mm

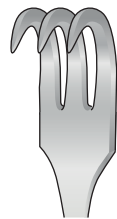


KOCHER  
BT-141/BT-148  
220 mm

Acuto  
Sharp  
Spitz  
Pointu  
Agudo



**BT-141**  
16 x 9 mm



**BT-143**  
16 x 14 mm

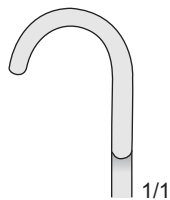


**BT-145**  
16 x 20 mm



**BT-147**  
16 x 30 mm

Smusso  
Blunt  
Stumpf  
Mousse  
Romo



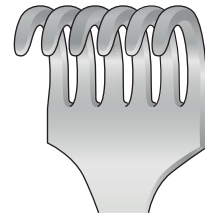
**BT-142**  
16 x 9 mm



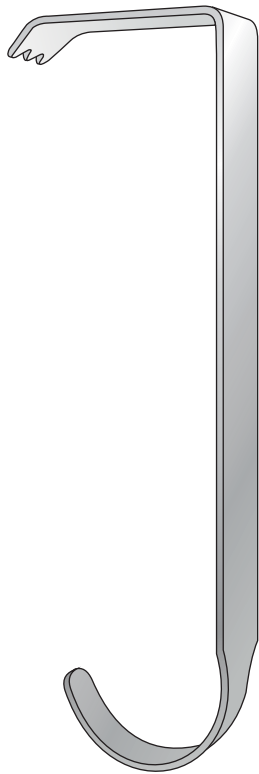
**BT-144**  
16 x 14 mm



**BT-146**  
16 x 20 mm



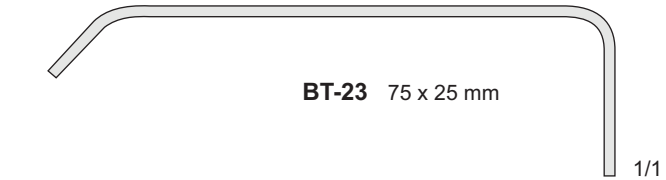
**BT-148**  
16 x 30 mm



HIBBS  
**BT-23/BT-24**  
240 mm

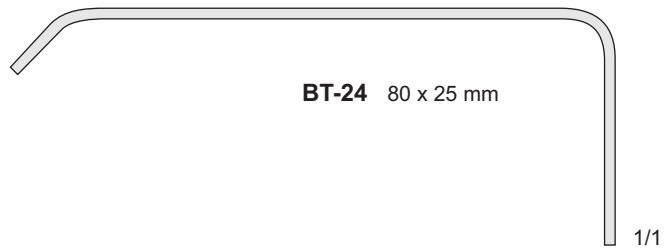


1/1



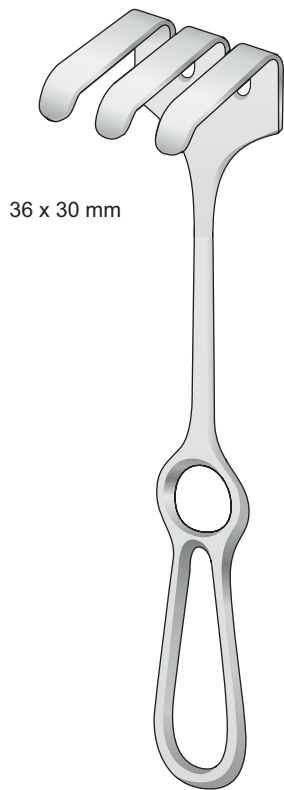
**BT-23** 75 x 25 mm

1/1



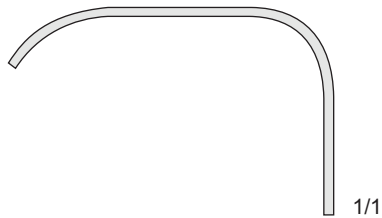
**BT-24** 80 x 25 mm

1/1

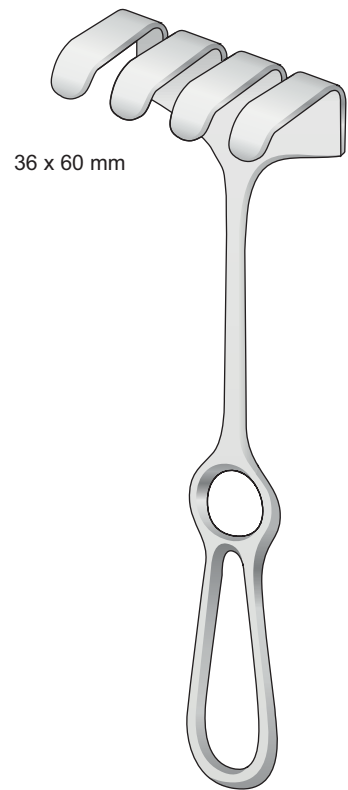


36 x 30 mm

OLLIER  
**BT-124**  
225 mm



1/1

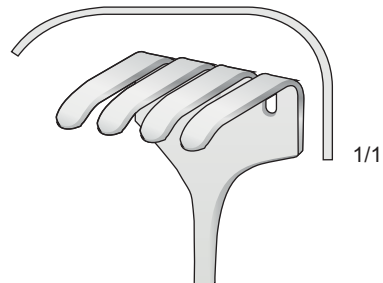


36 x 60 mm

OLLIER  
**BT-125**  
225 mm

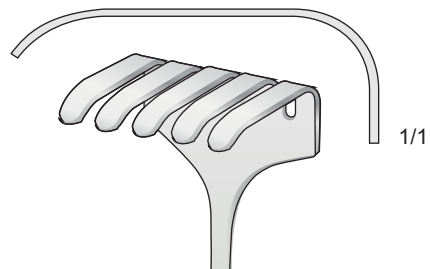


40 x 40 mm



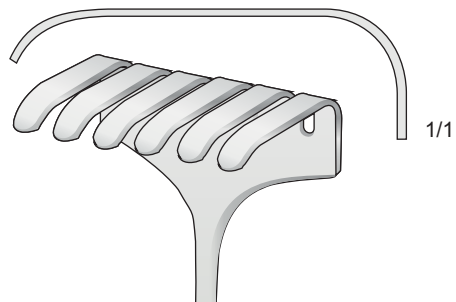
**BT-120**

45 x 50 mm



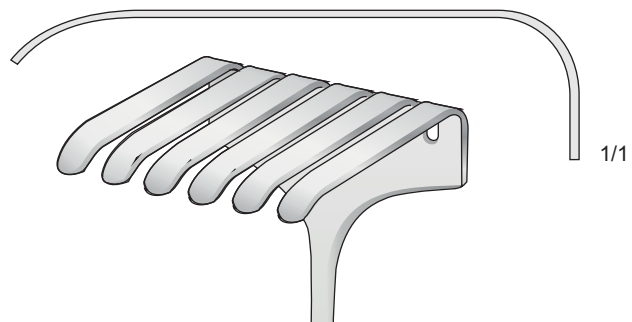
**BT-121**

50 x 60 mm

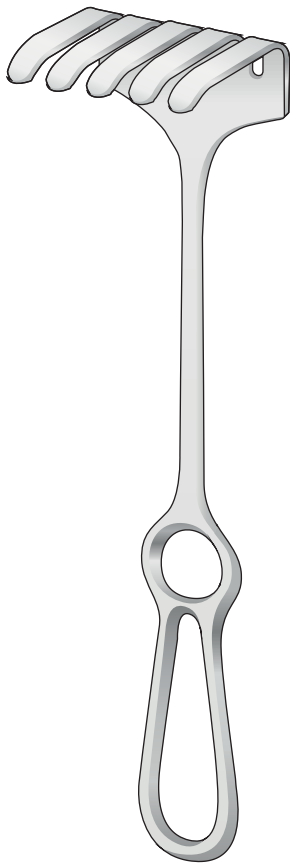


**BT-122**

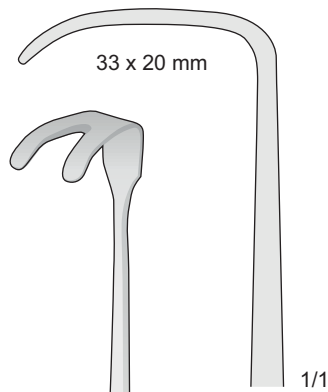
70 x 70 mm



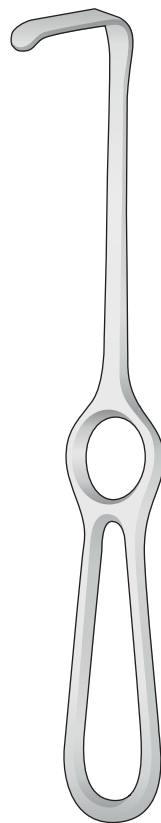
**BT-123**



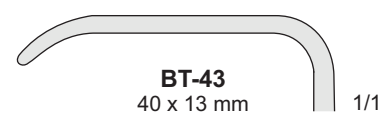
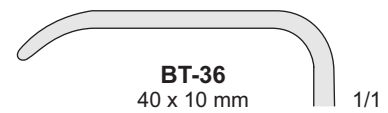
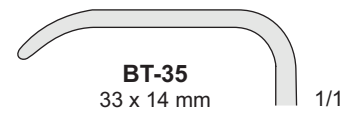
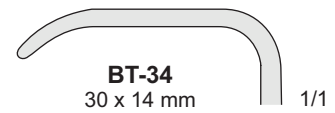
ISRAEL  
**BT-120/BT-123**  
250 mm

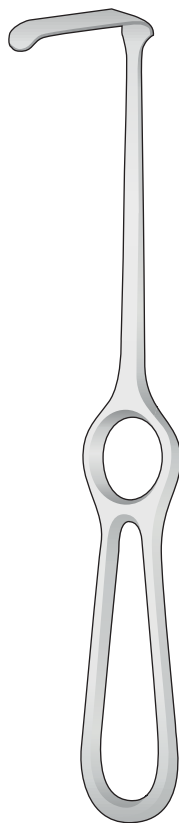


WASSMUND  
BT-69  
220 mm

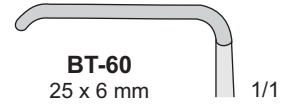


LANGENBECK  
BT-33/BT-43  
210 mm

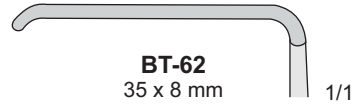




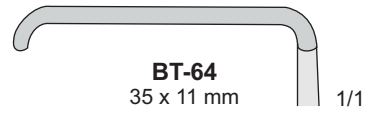
KOCHER-LANGENBECK  
BT-60/BT-263  
215 mm



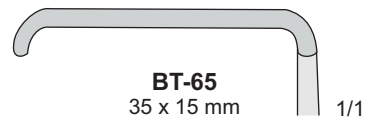
BT-60  
25 x 6 mm



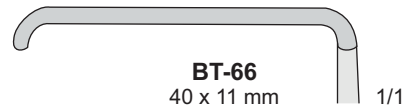
BT-62  
35 x 8 mm



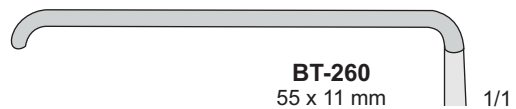
BT-64  
35 x 11 mm



BT-65  
35 x 15 mm



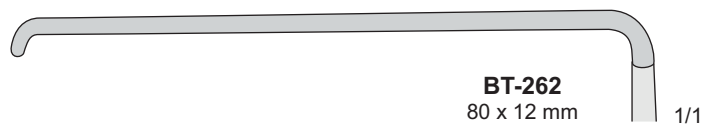
BT-66  
40 x 11 mm



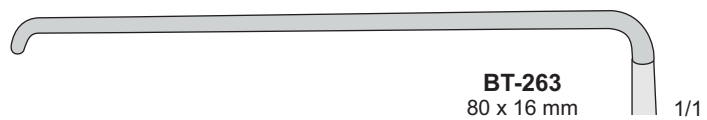
BT-260  
55 x 11 mm



BT-261  
70 x 14 mm



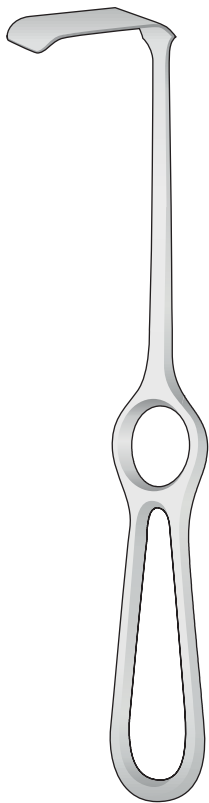
BT-262  
80 x 12 mm



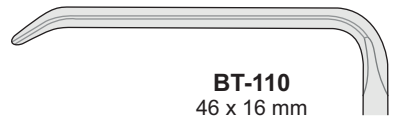
BT-263  
80 x 16 mm



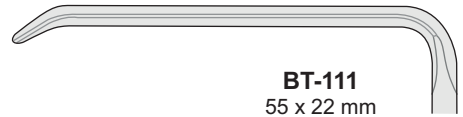
SAUERBRUCH  
BT-110/BT-112  
225 mm



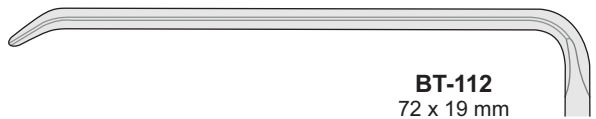
KOCHER  
BT-250/BT-254  
230 mm



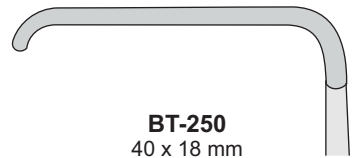
BT-110  
46 x 16 mm 1/1



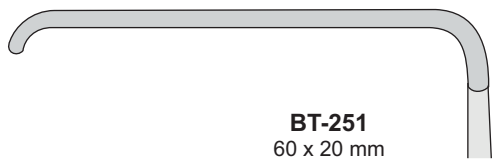
BT-111  
55 x 22 mm 1/1



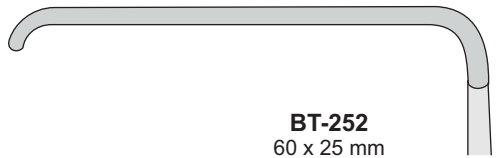
BT-112  
72 x 19 mm 1/1



BT-250  
40 x 18 mm 1/1



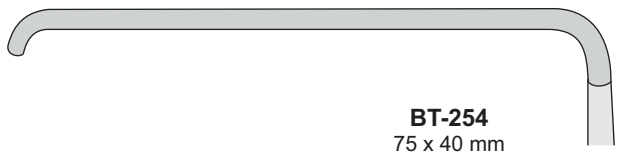
BT-251  
60 x 20 mm 1/1



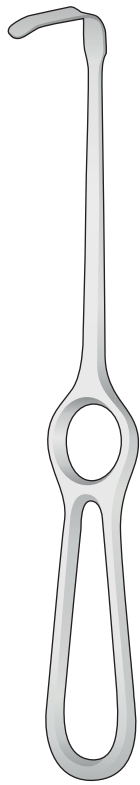
BT-252  
60 x 25 mm 1/1



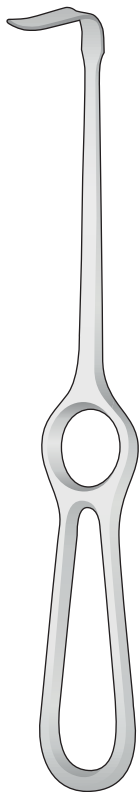
BT-253  
75 x 30 mm 1/1



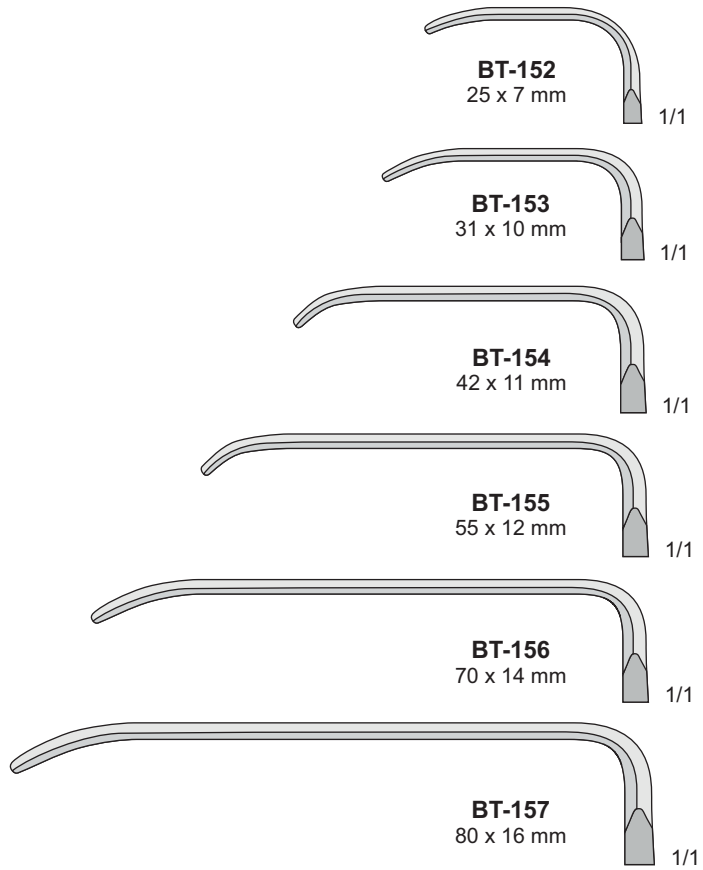
BT-254  
75 x 40 mm 1/1



OBWEGESER  
BT-152/BT-157  
220 mm



OBWEGESER  
BT-92/BT-100  
220 mm



BT-152  
25 x 7 mm

1/1

BT-153  
31 x 10 mm

1/1

BT-154  
42 x 11 mm

1/1

BT-155  
55 x 12 mm

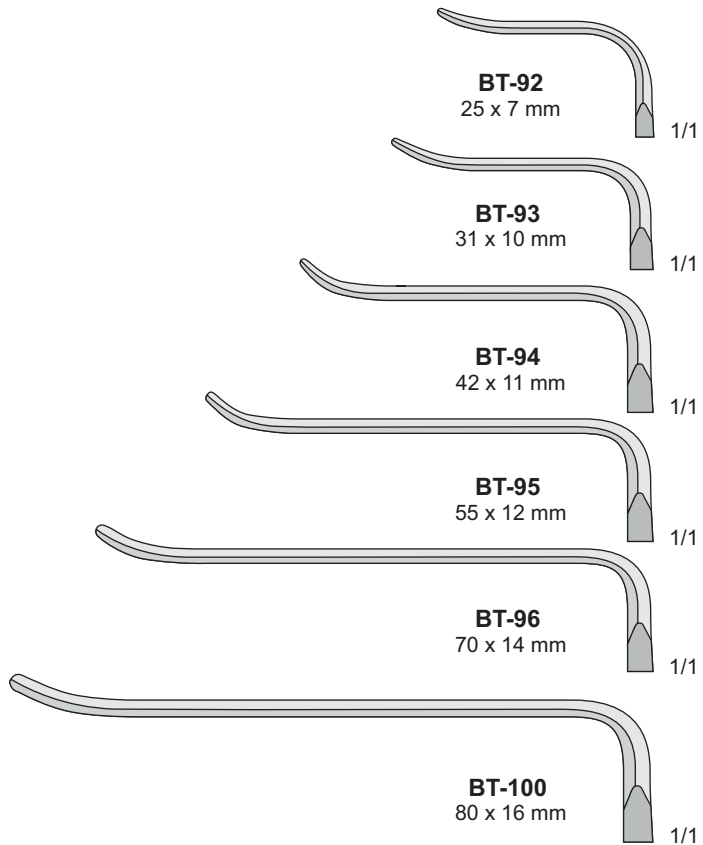
1/1

BT-156  
70 x 14 mm

1/1

BT-157  
80 x 16 mm

1/1



BT-92  
25 x 7 mm

1/1

BT-93  
31 x 10 mm

1/1

BT-94  
42 x 11 mm

1/1

BT-95  
55 x 12 mm

1/1

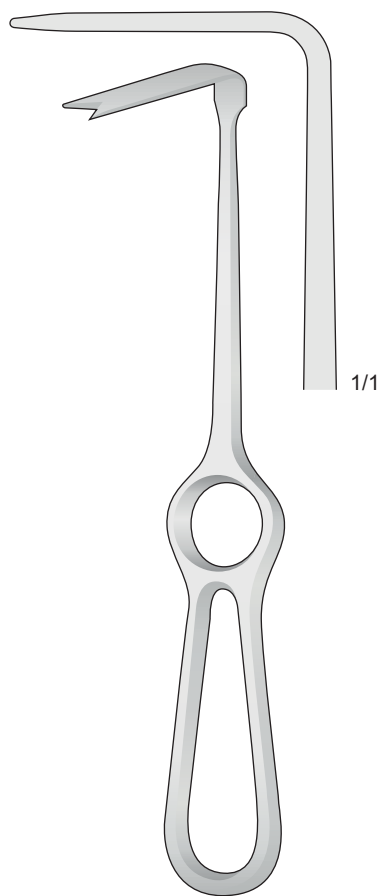
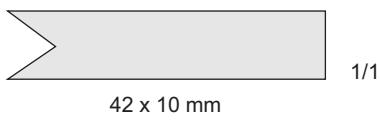
BT-96  
70 x 14 mm

1/1

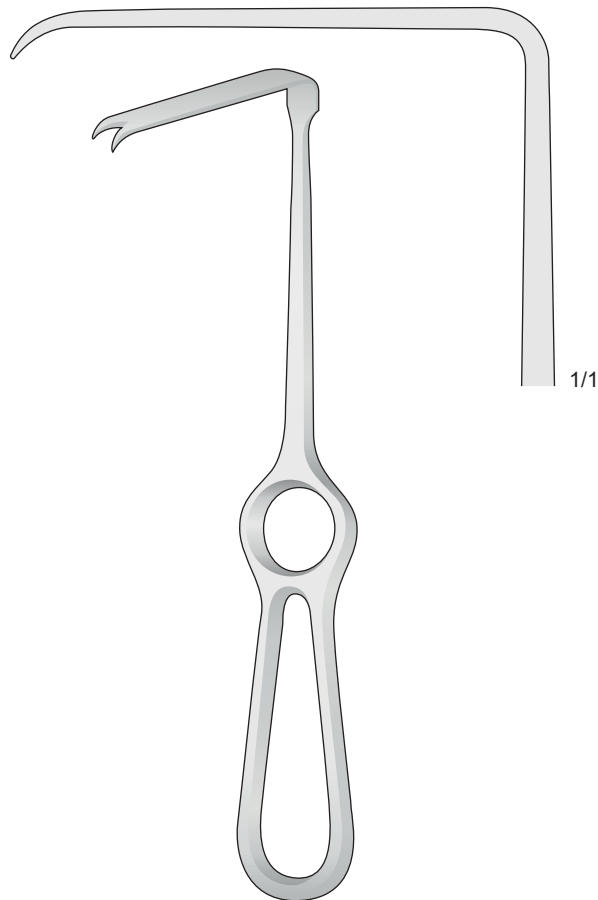
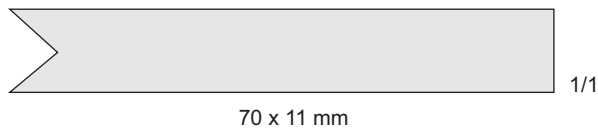
BT-100  
80 x 16 mm

1/1

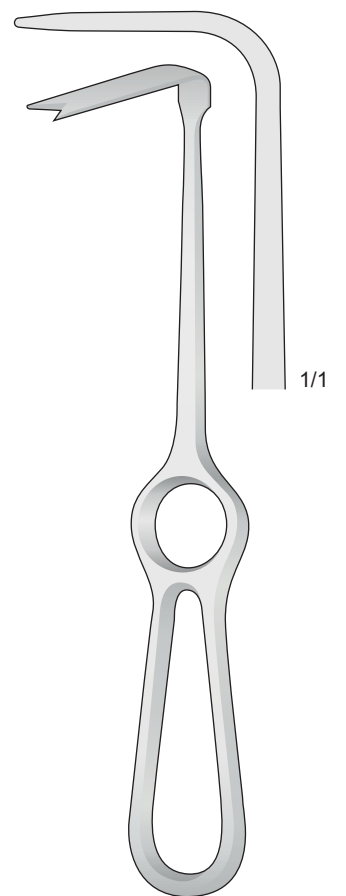
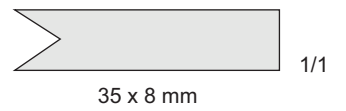




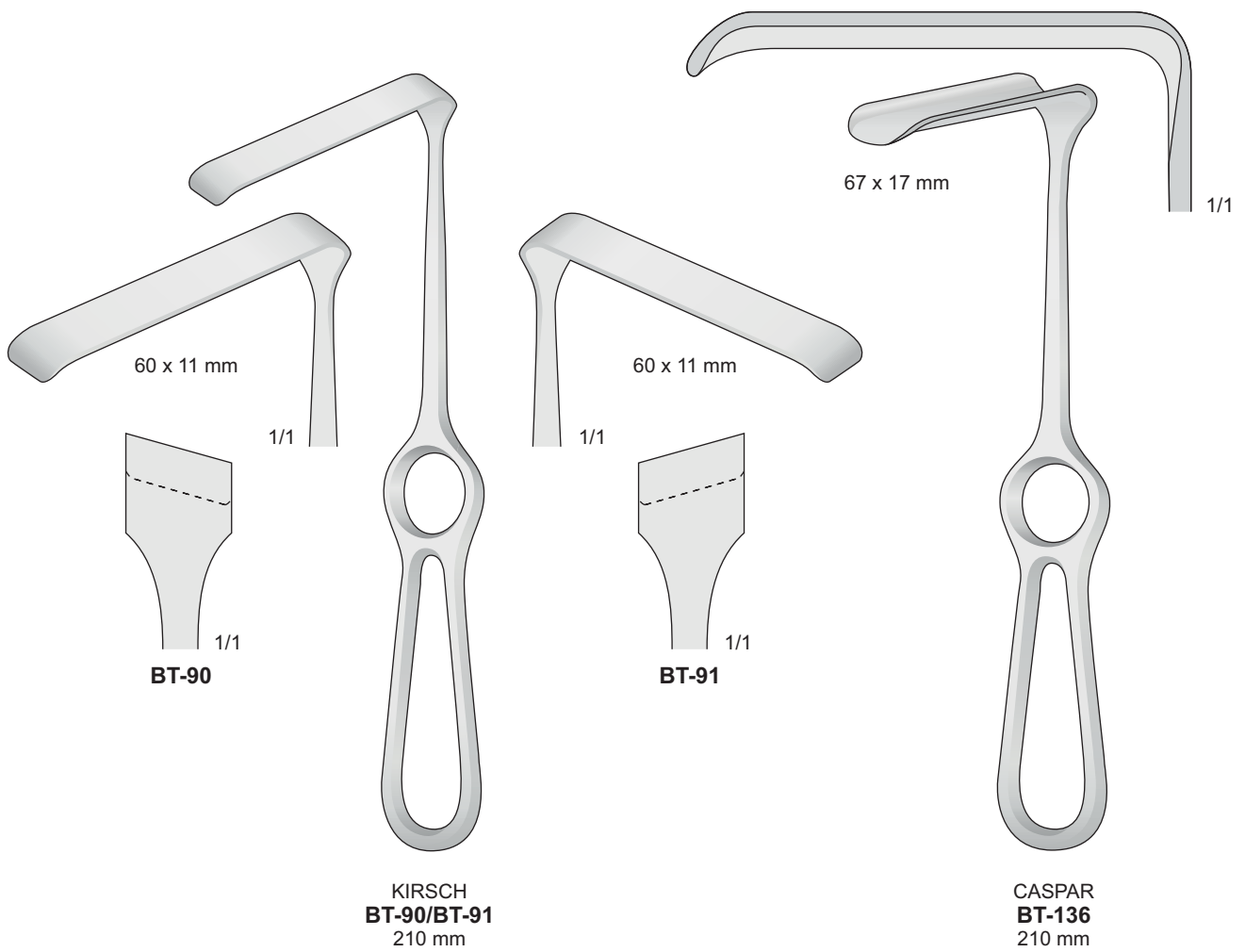
OBWEGESER  
**BT-67**  
215 mm

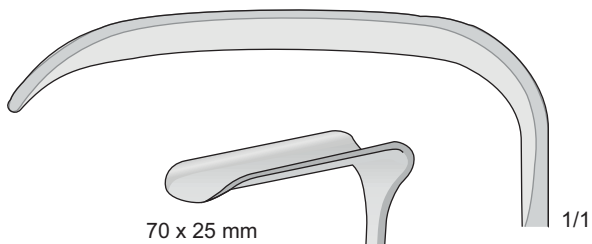


**BT-68**  
220 mm



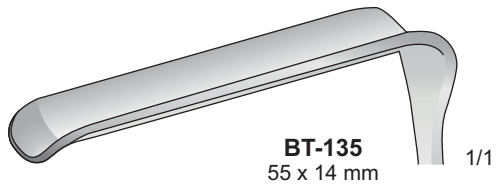
**BT-130**  
215 mm





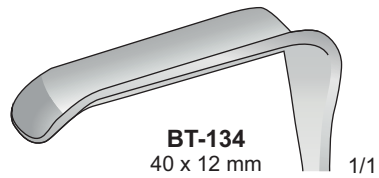
70 x 25 mm

1/1



**BT-135**  
55 x 14 mm

1/1

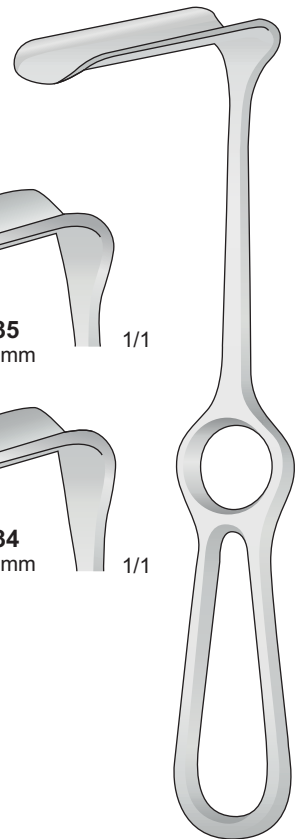


**BT-134**  
40 x 12 mm

1/1



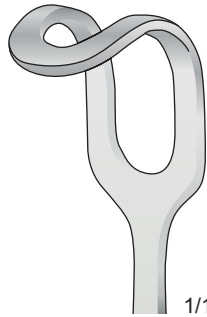
**KOCHER**  
**BT-137**  
240 mm



**DOCKHORN**  
**BT-134/BT-135**  
210 mm

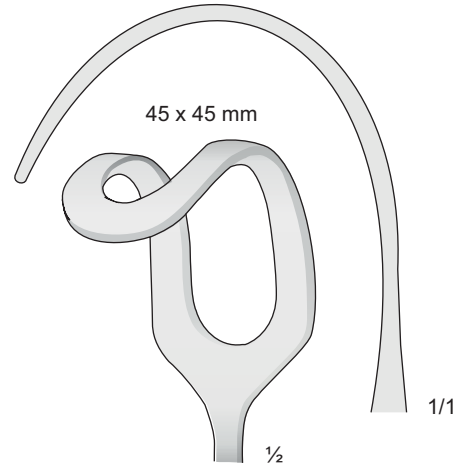


15 x 15 mm



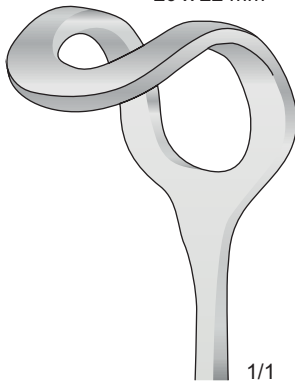
**BT-80**  
225 mm

45 x 45 mm



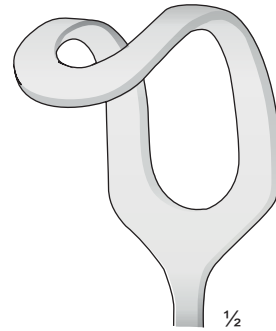
**BT-180**  
255 mm

20 x 22 mm



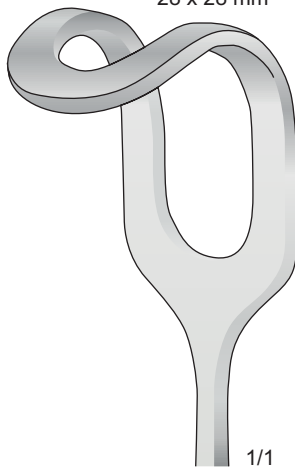
**BT-81**  
225 mm

45 x 50 mm



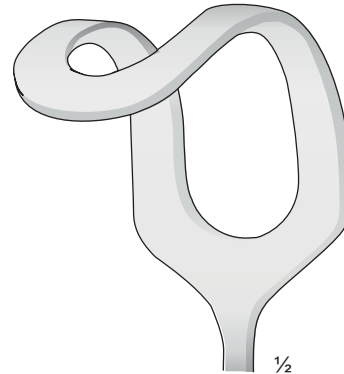
**BT-181**  
255 mm

28 x 28 mm



**BT-82**  
225 mm

55 x 70 mm



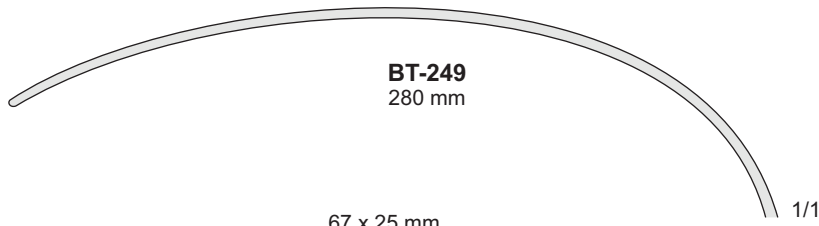
**BT-182**  
255 mm

MIDDELDORPF  
**BT-80/BT-82**  
225 mm

MIDDELDORPF  
**BT-180**  
255 mm

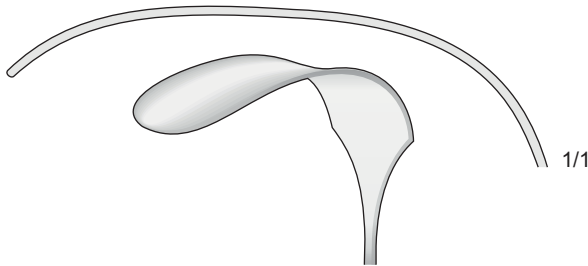


100 x 35 mm



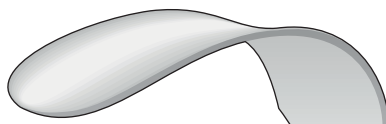
**BT-249**  
280 mm

67 x 25 mm

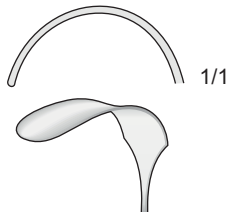


**BT-248**  
280 mm

**BT-270** 80x42 mm  
**BT-271** 80x50 mm  
**BT-272** 80x60 mm



22 x 15 mm

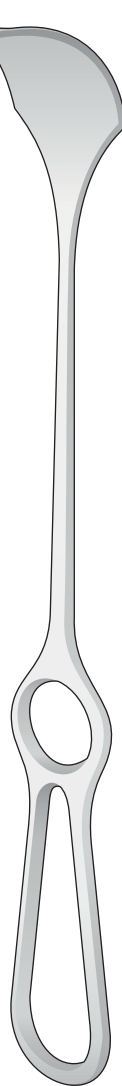


**BT-246**  
280 mm

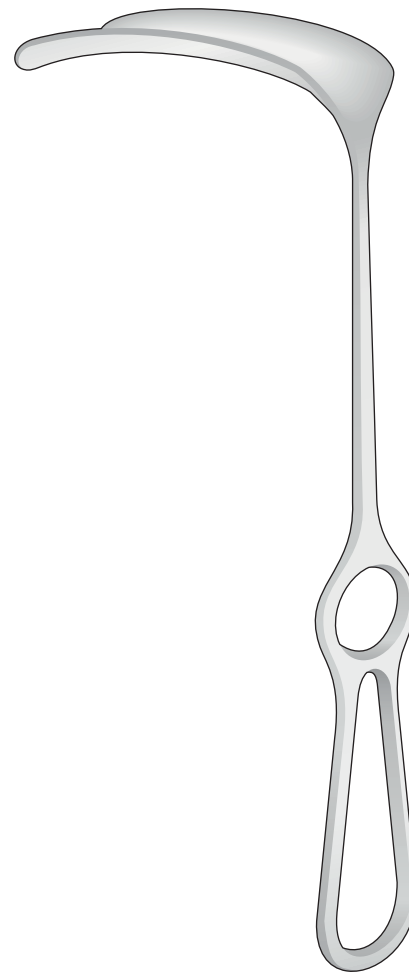
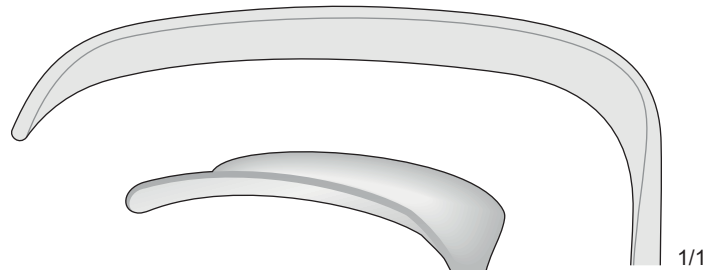
38 x 20 mm



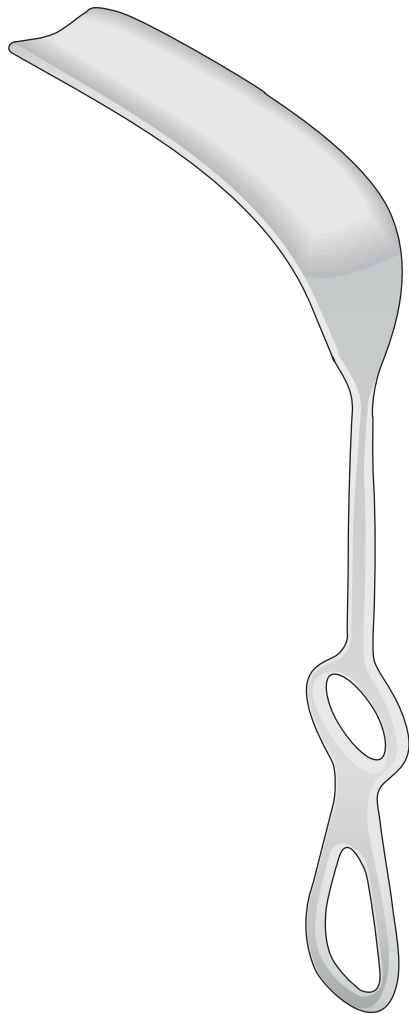
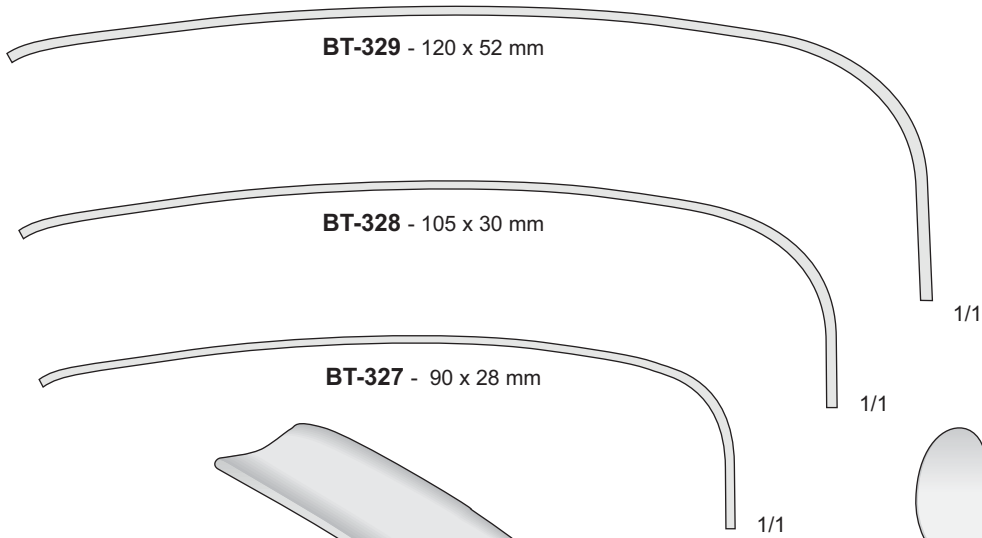
**BT-247**  
280 mm



KOCHER  
**BT-246/BT-249**  
280 mm



KOCHER  
**BT-270/BT-272**  
250 mm

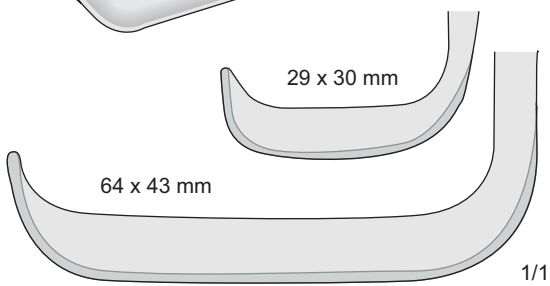
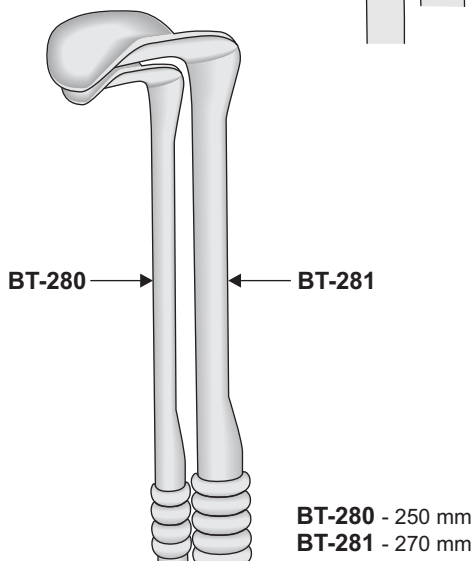
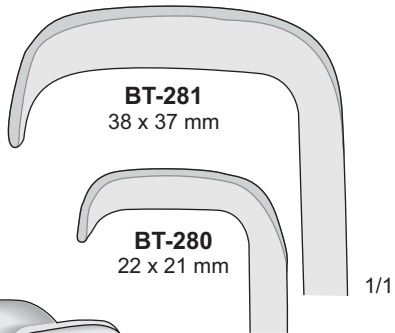


**DOYEN-STILLE**  
**BT-327/BT-329**  
220 mm

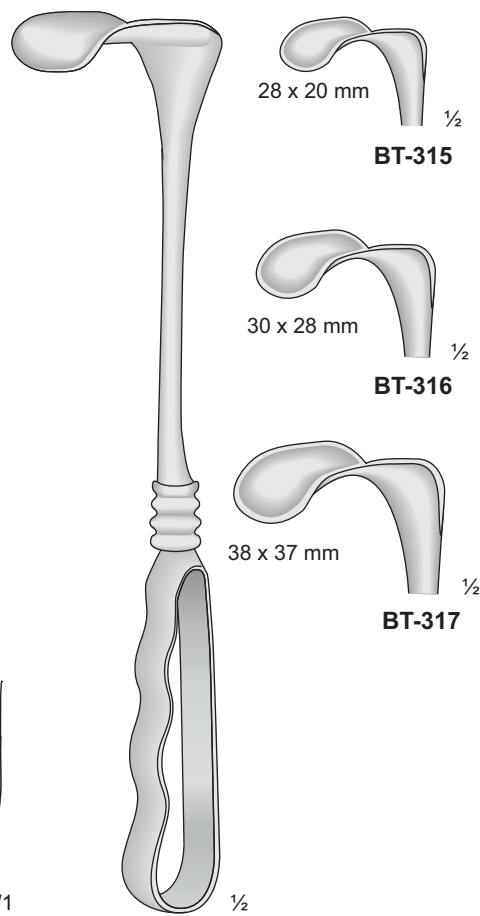


50 x 85 mm

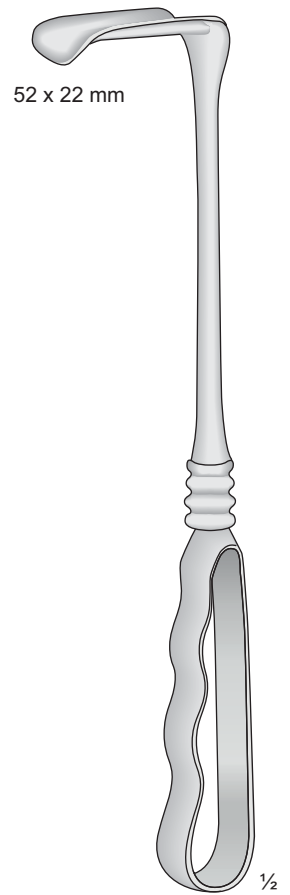
**DOYEN**  
**BT-330**  
250 mm



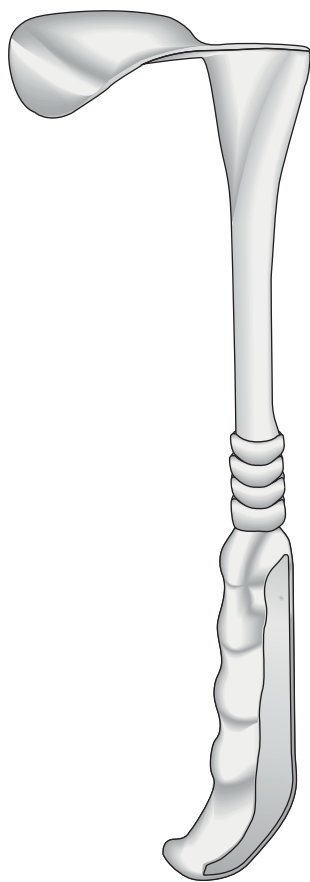
RICHARDSON-EASTMAN  
**BT-290**  
Set 2 pezzi



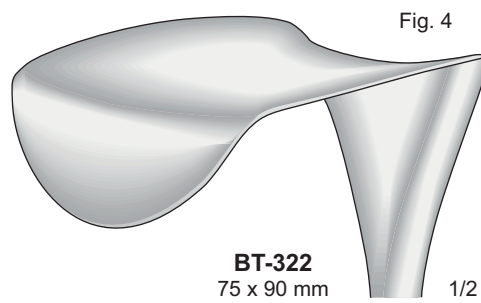
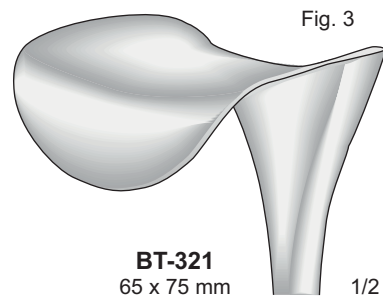
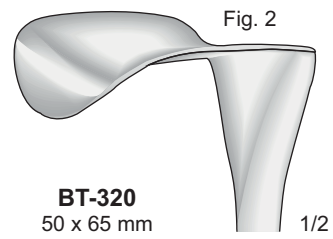
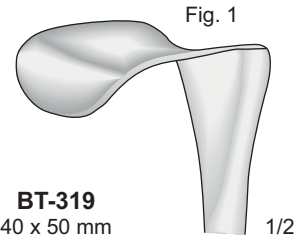
RICHARDSON  
**BT-315/BT-317**  
240 mm



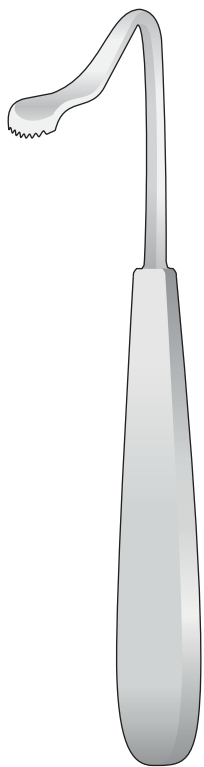
RICHARDSON  
**BT-318**  
240 mm



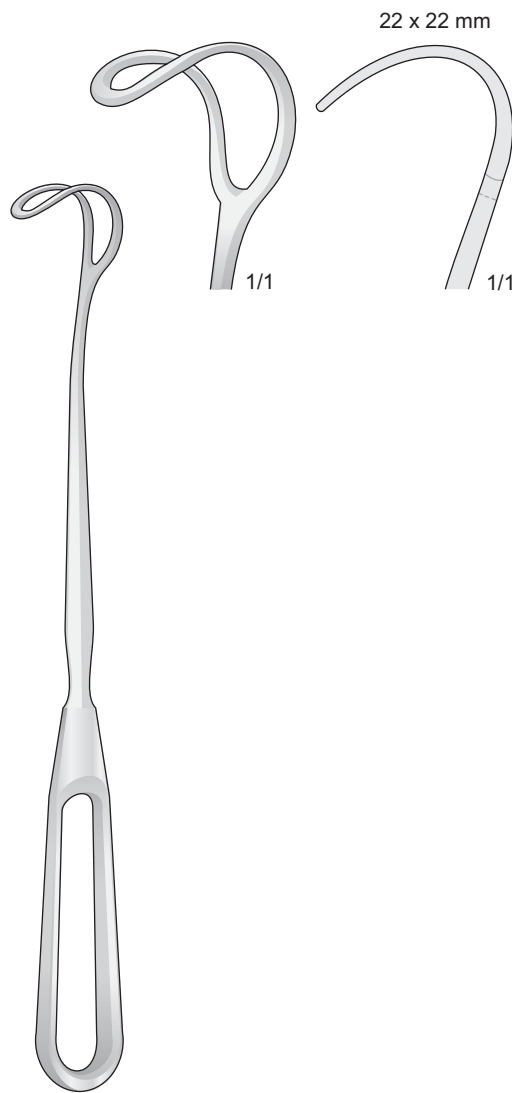
KELLY  
BT-319/BT-322  
260 mm



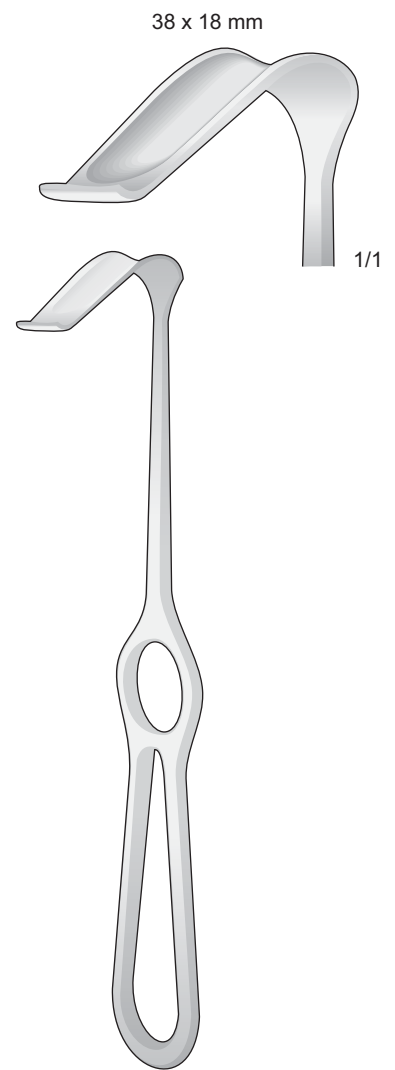




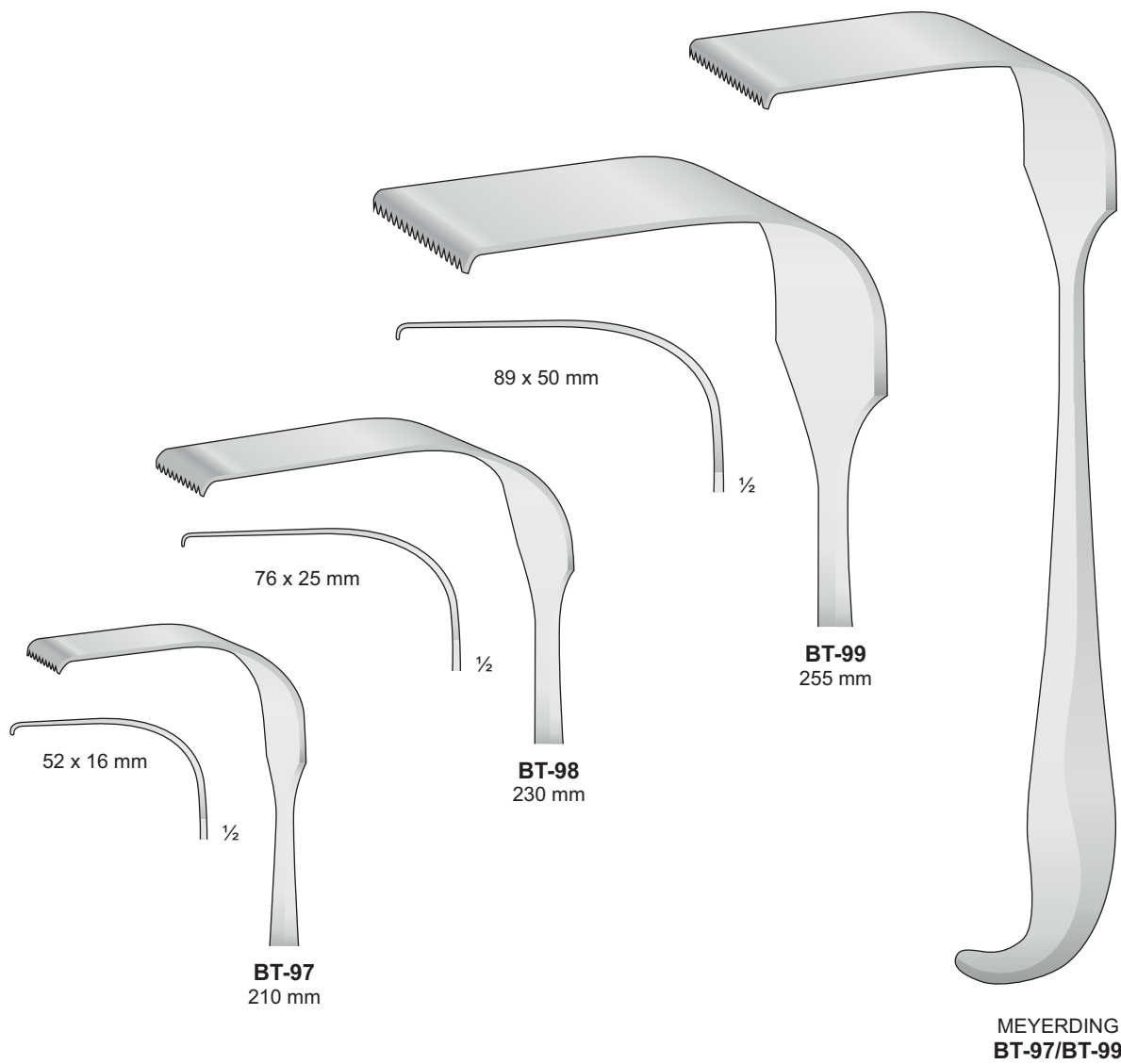
**BOWLED-HENRY**  
**DO-175**  
170 mm

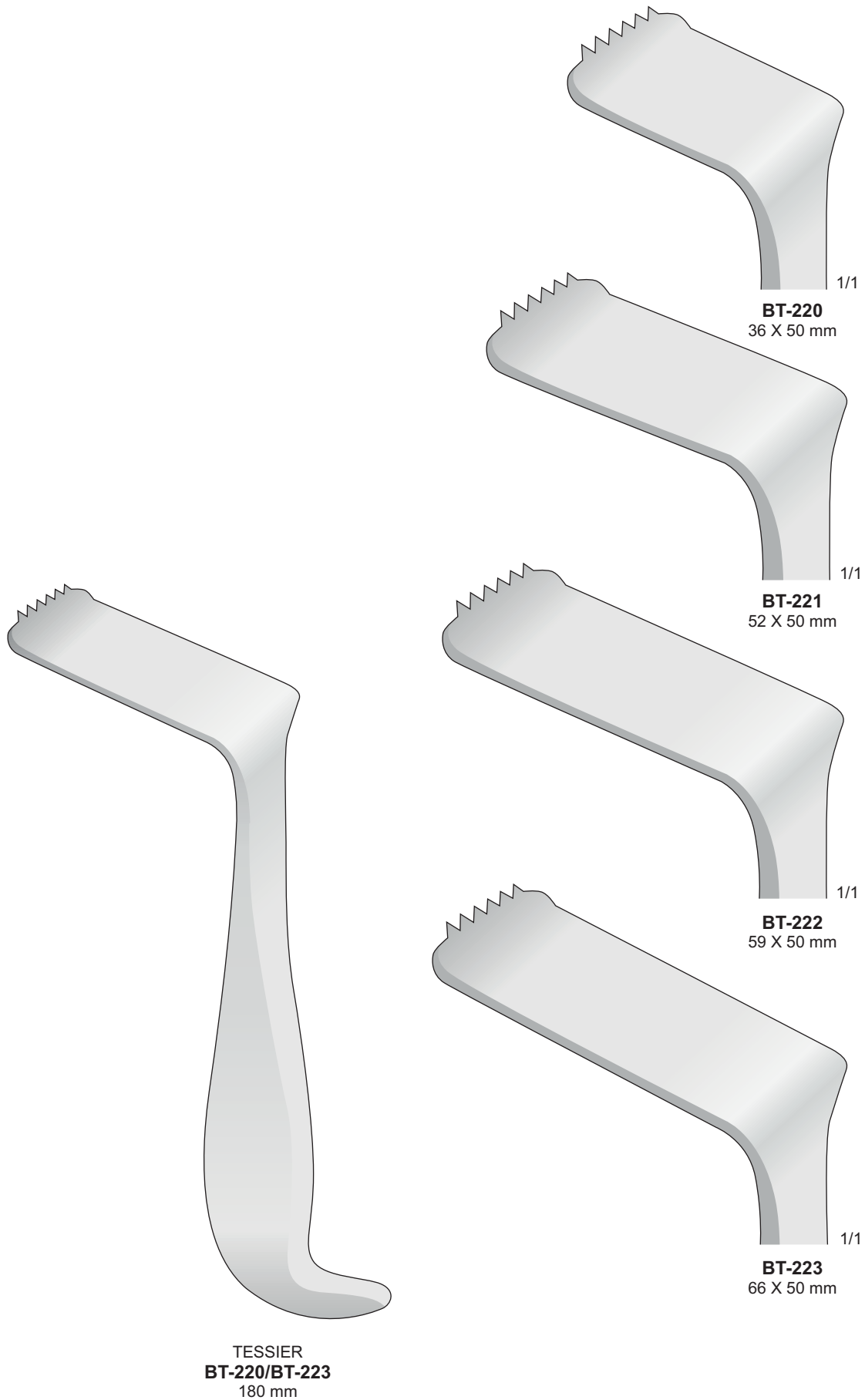


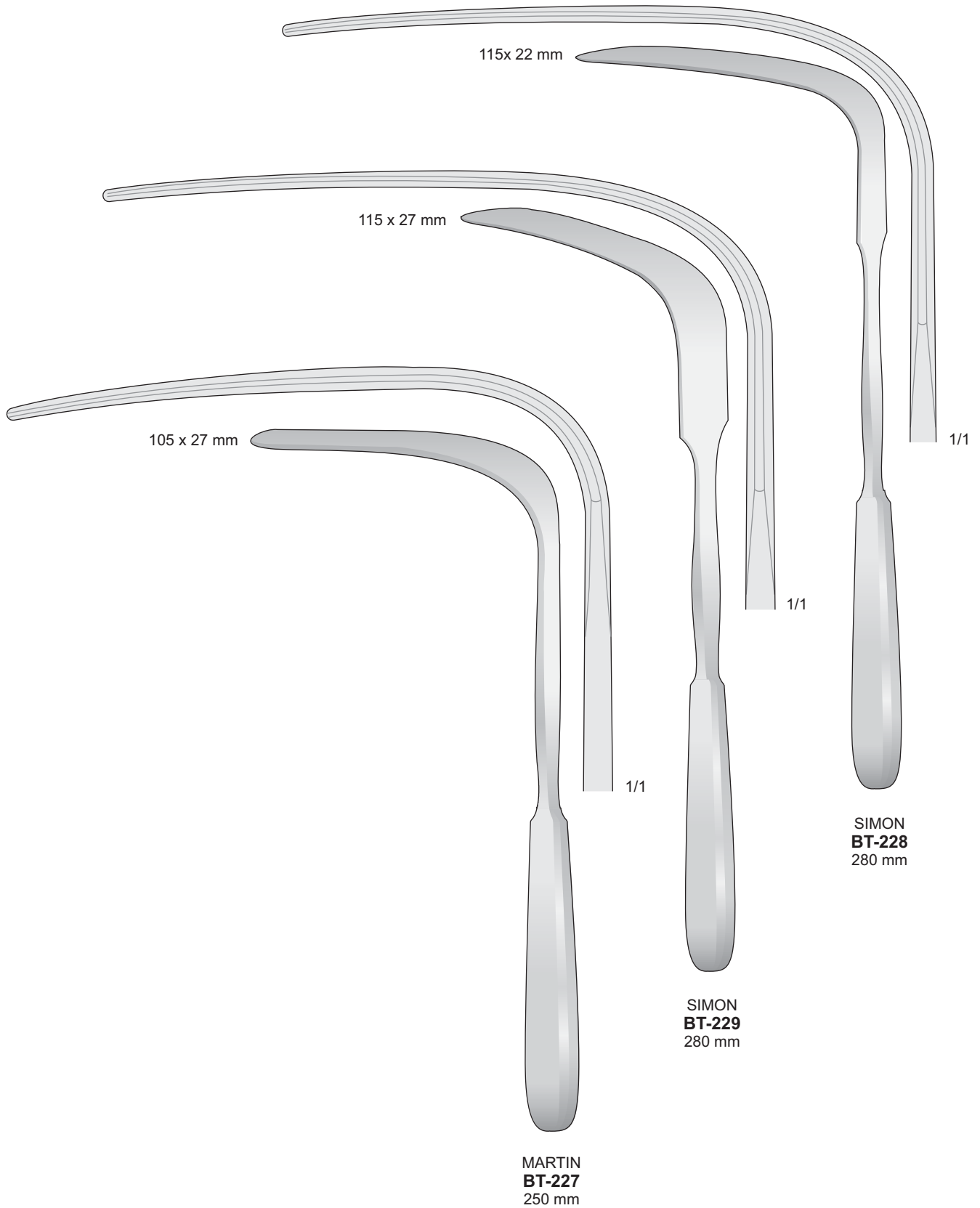
**GREENE**  
**BT-131**  
225 mm

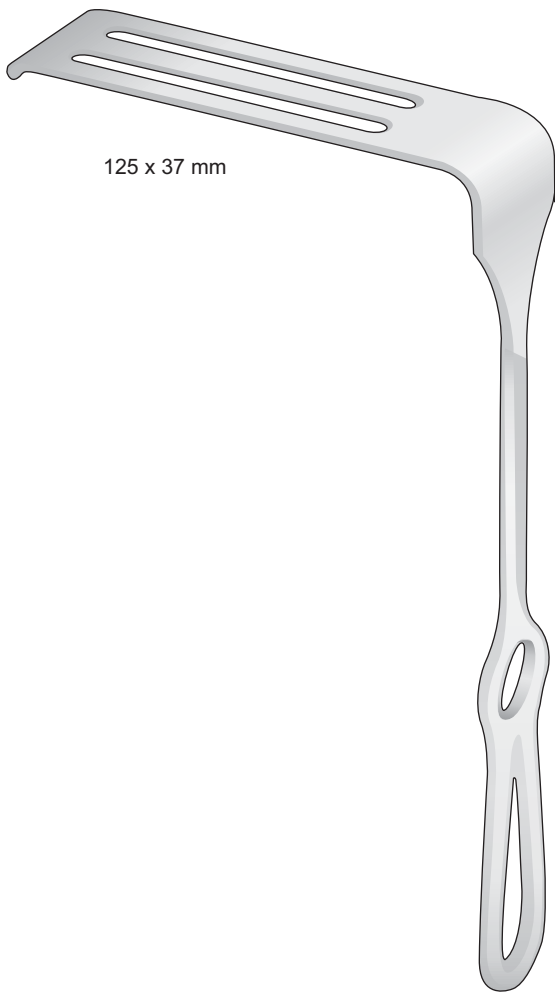
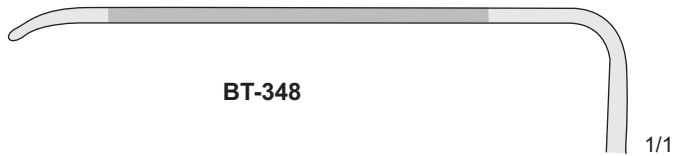
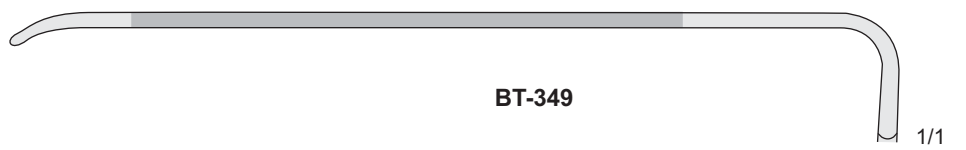
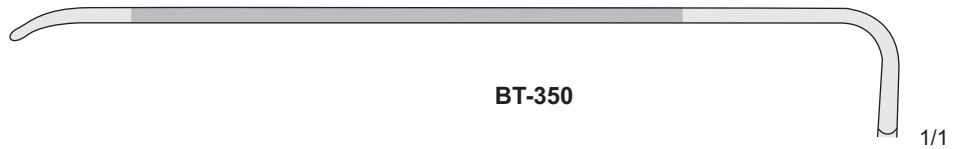
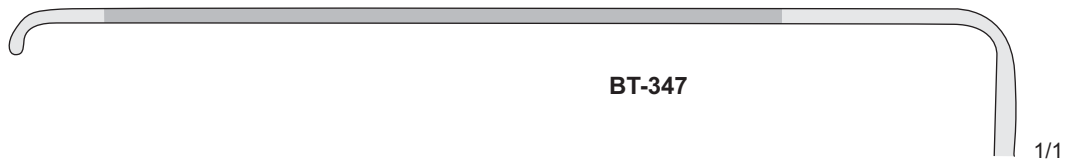


**BÜCHS**  
**BT-133**  
205 mm

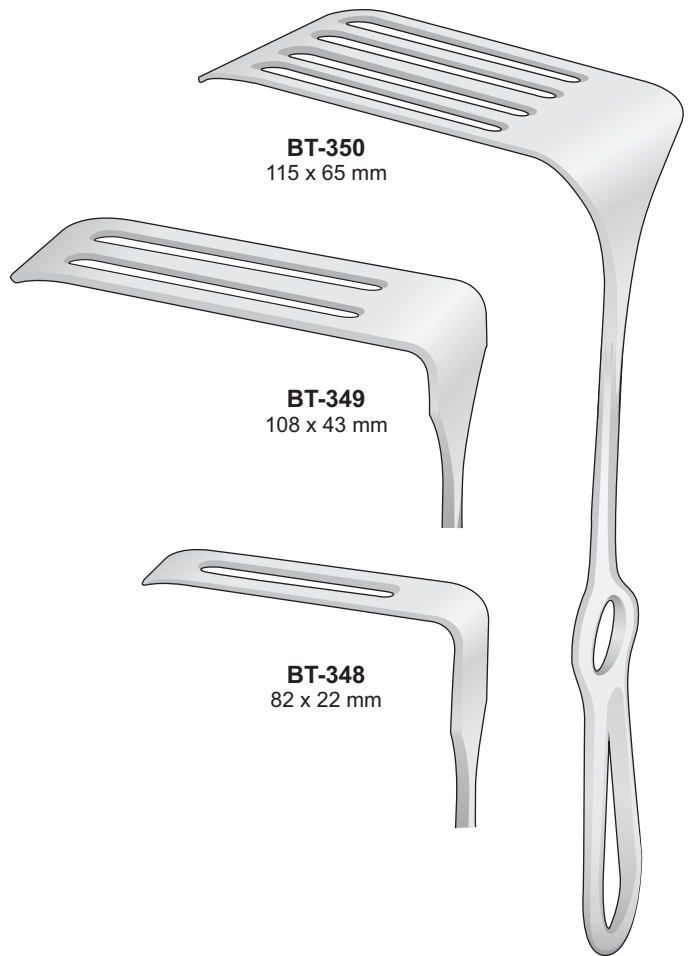








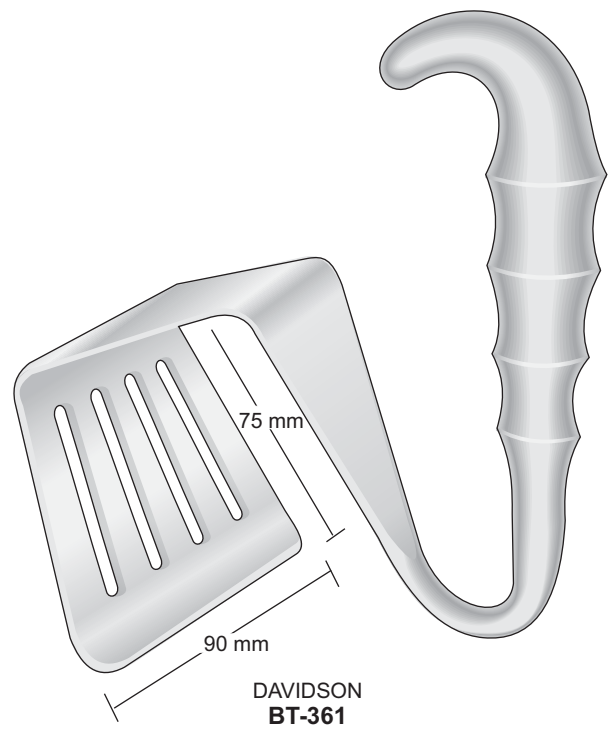
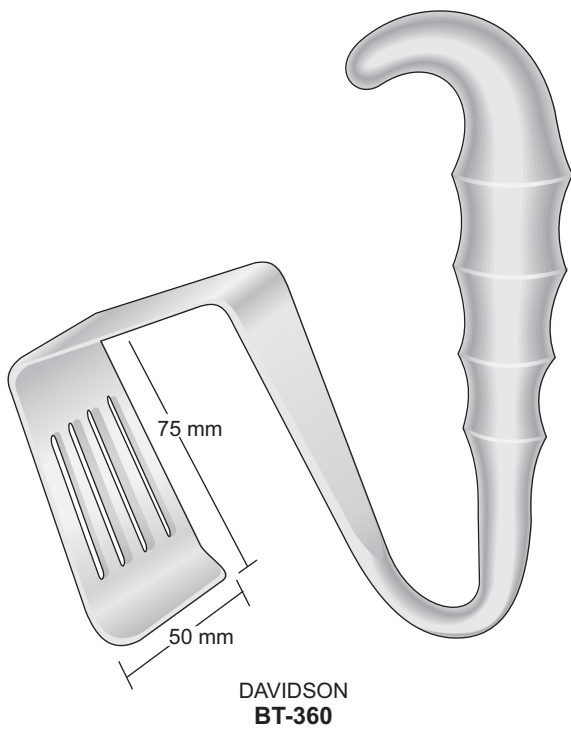
SAUERBRUCH  
BT-347  
260 mm

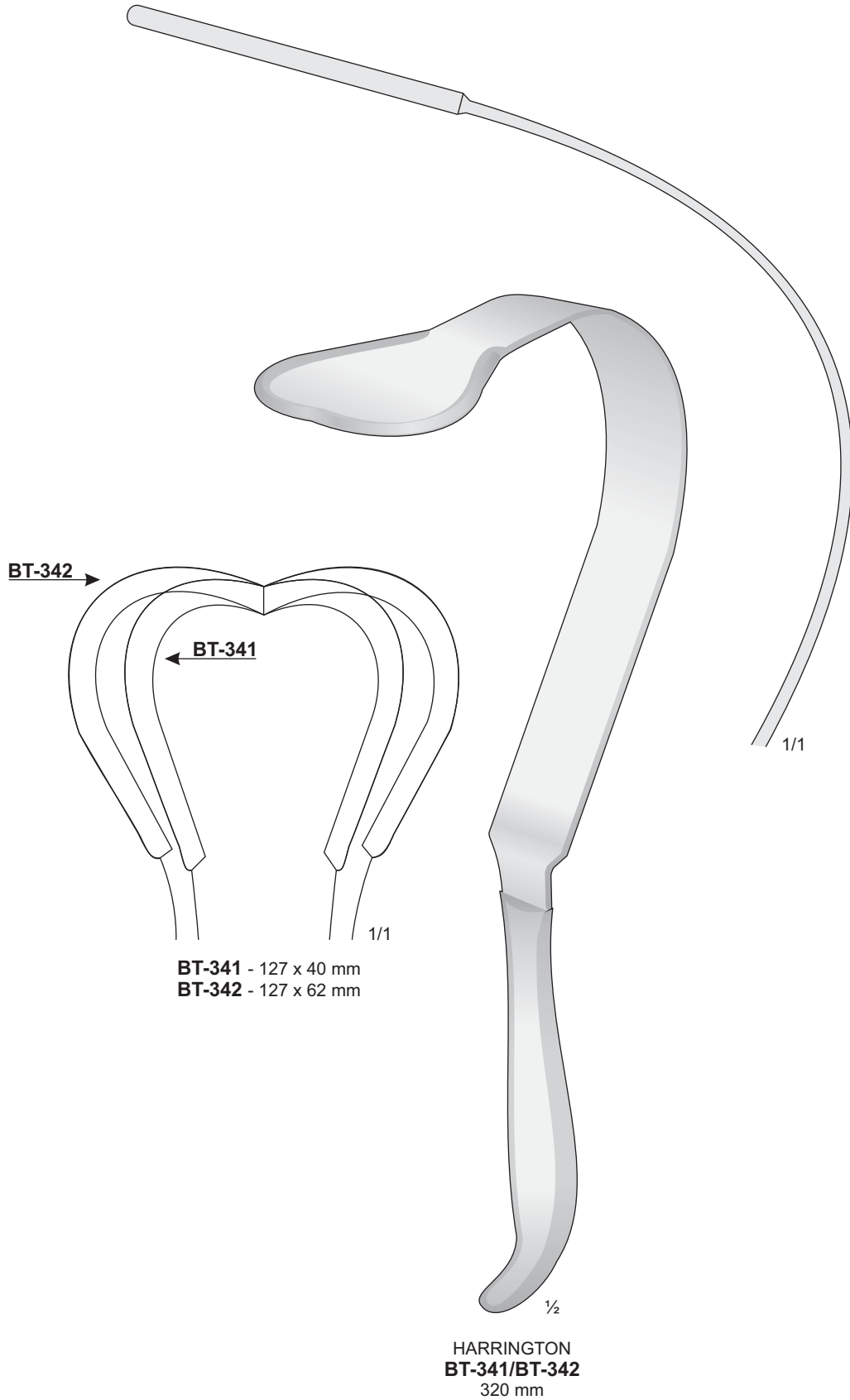


CORYLLOS  
BT-348/BT-350  
255 mm



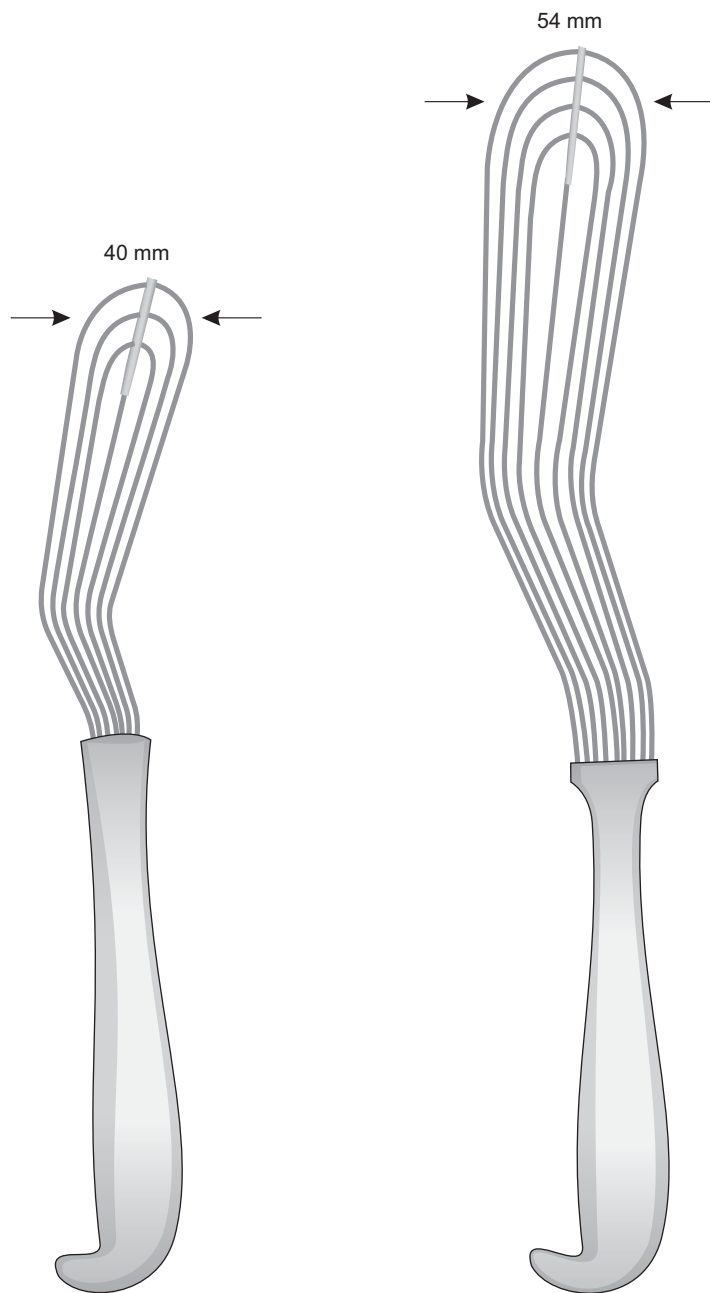
Retrattori per scapola  
Scapula retractors  
Scapula-Haken  
Ecarteurs pour scapula  
Separadores para scápula







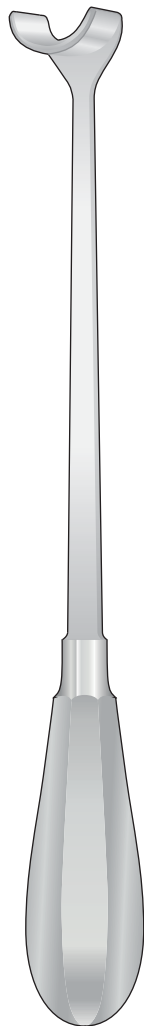
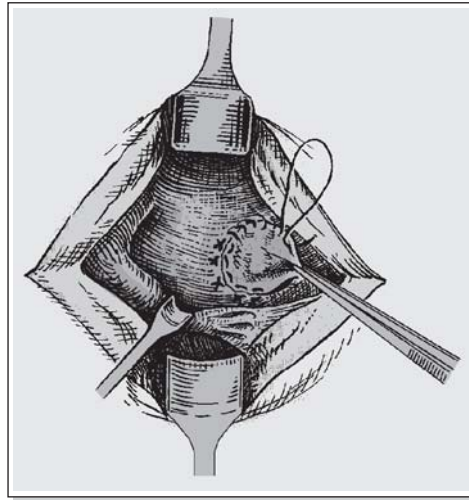
Spatole per polmone  
Lung spatulas  
Lungenspatel  
Spatules pulmonaires  
Espátulas pulmonares



ALLISON  
**BT-344**  
255 mm

ALLISON  
**BT-345**  
320 mm





ROSS  
BT-331/BT-336  
270 mm

Fig. 1



BT-331

Fig. 2



BT-332

Fig. 3



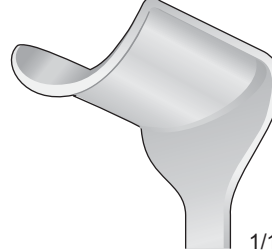
BT-333

Fig. 4



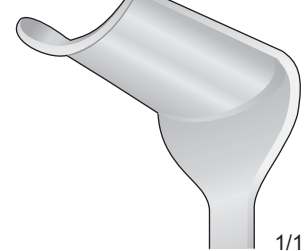
BT-334

Fig. 5

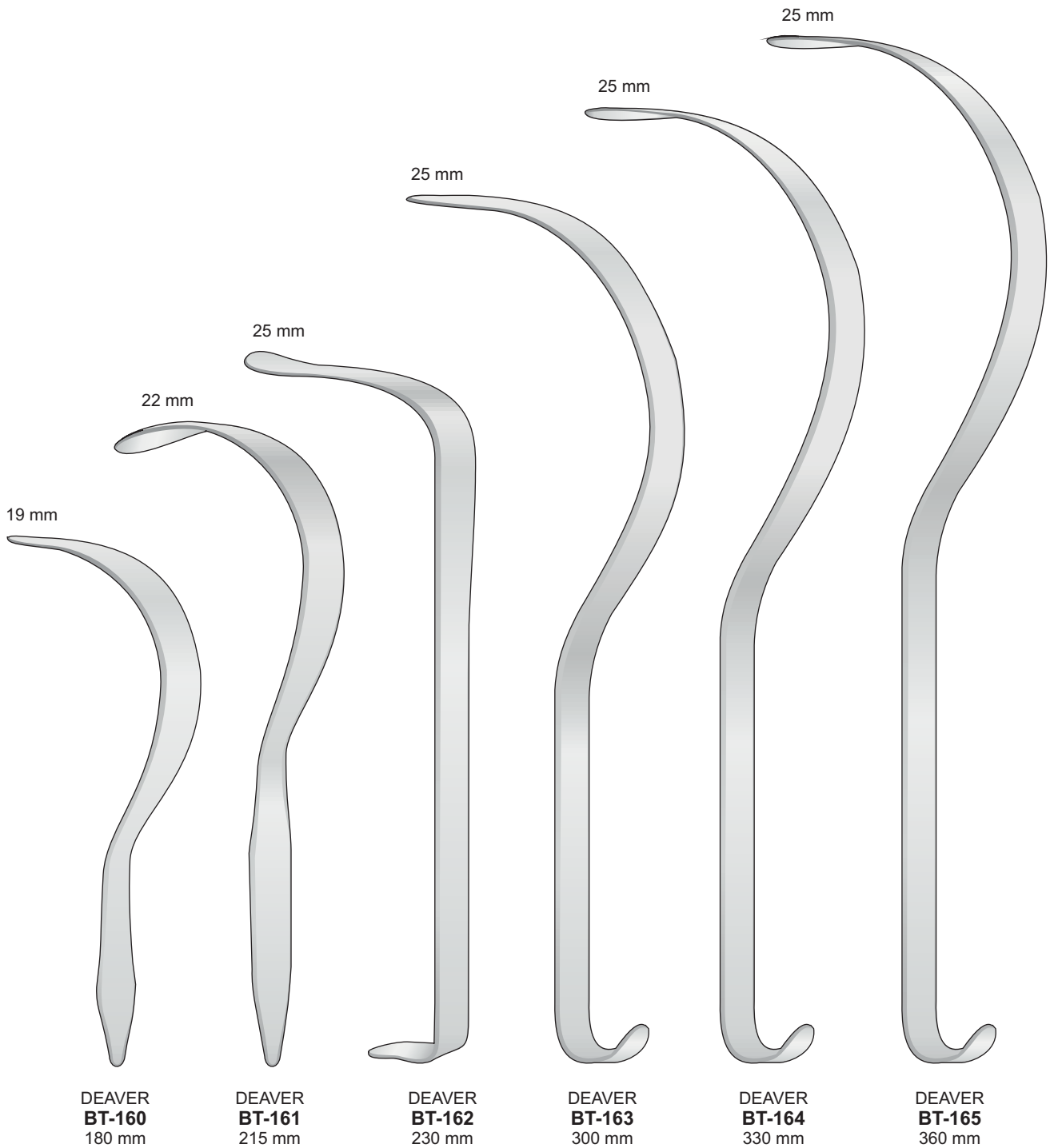


BT-335

Fig. 6

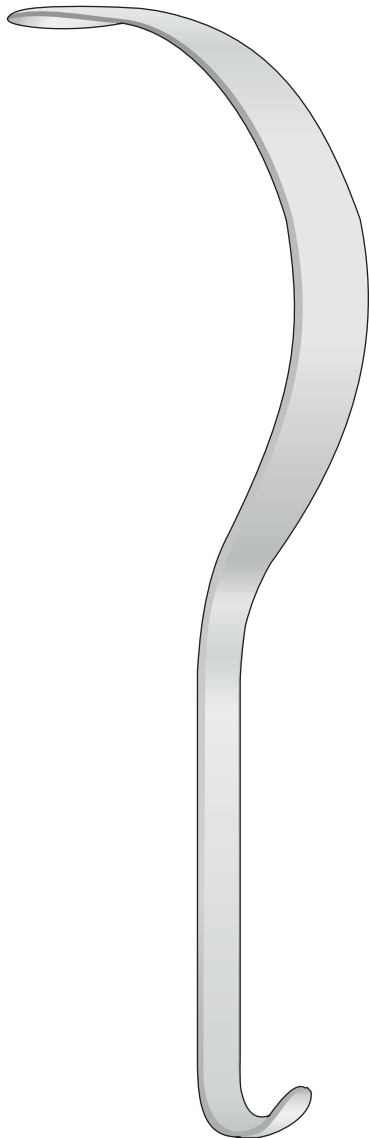


BT-336



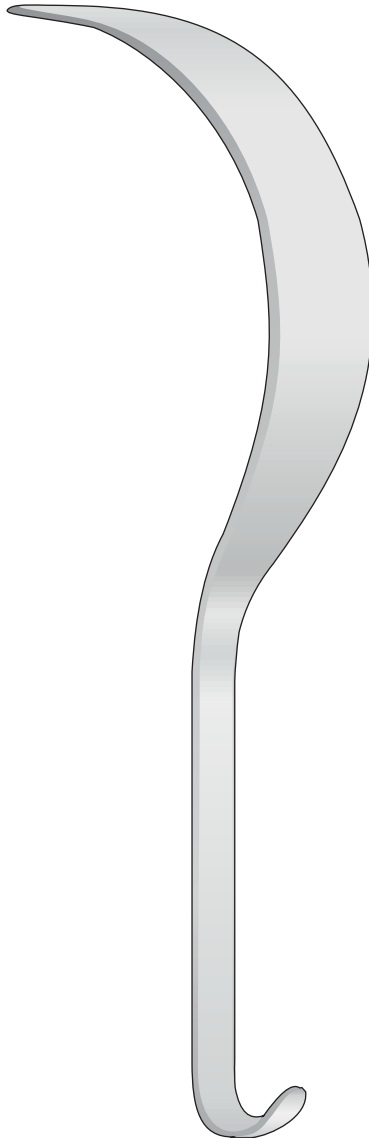


38 mm



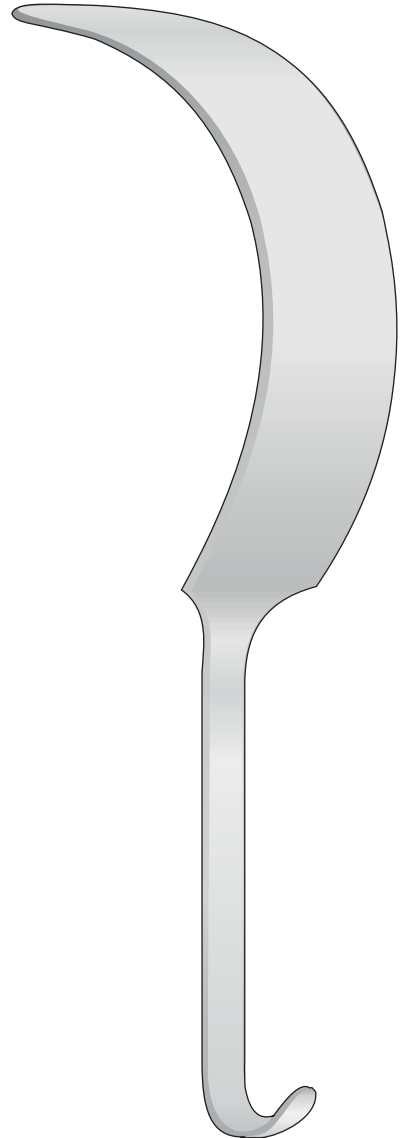
DEAVER  
**BT-166**  
300 mm

50 mm

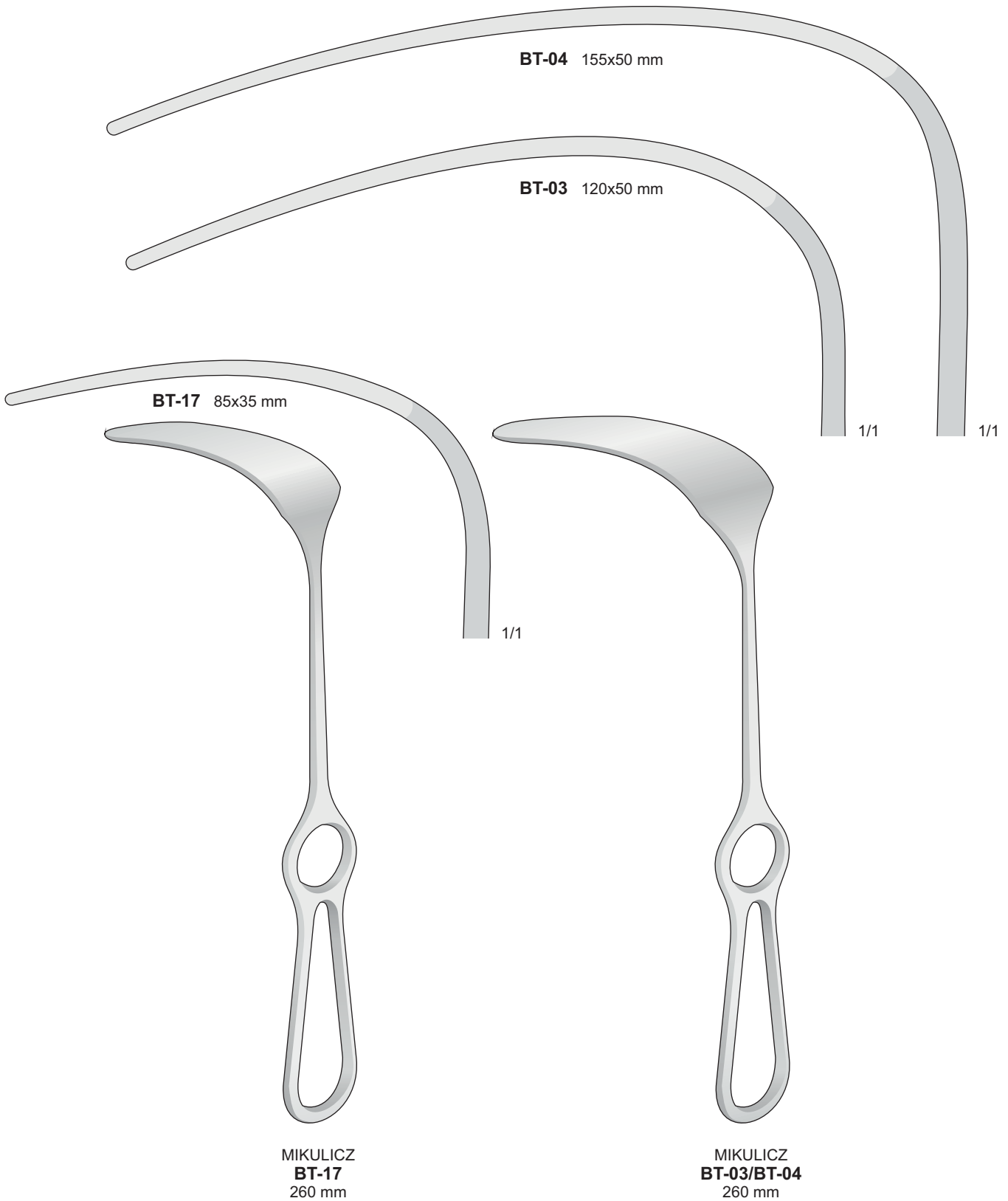


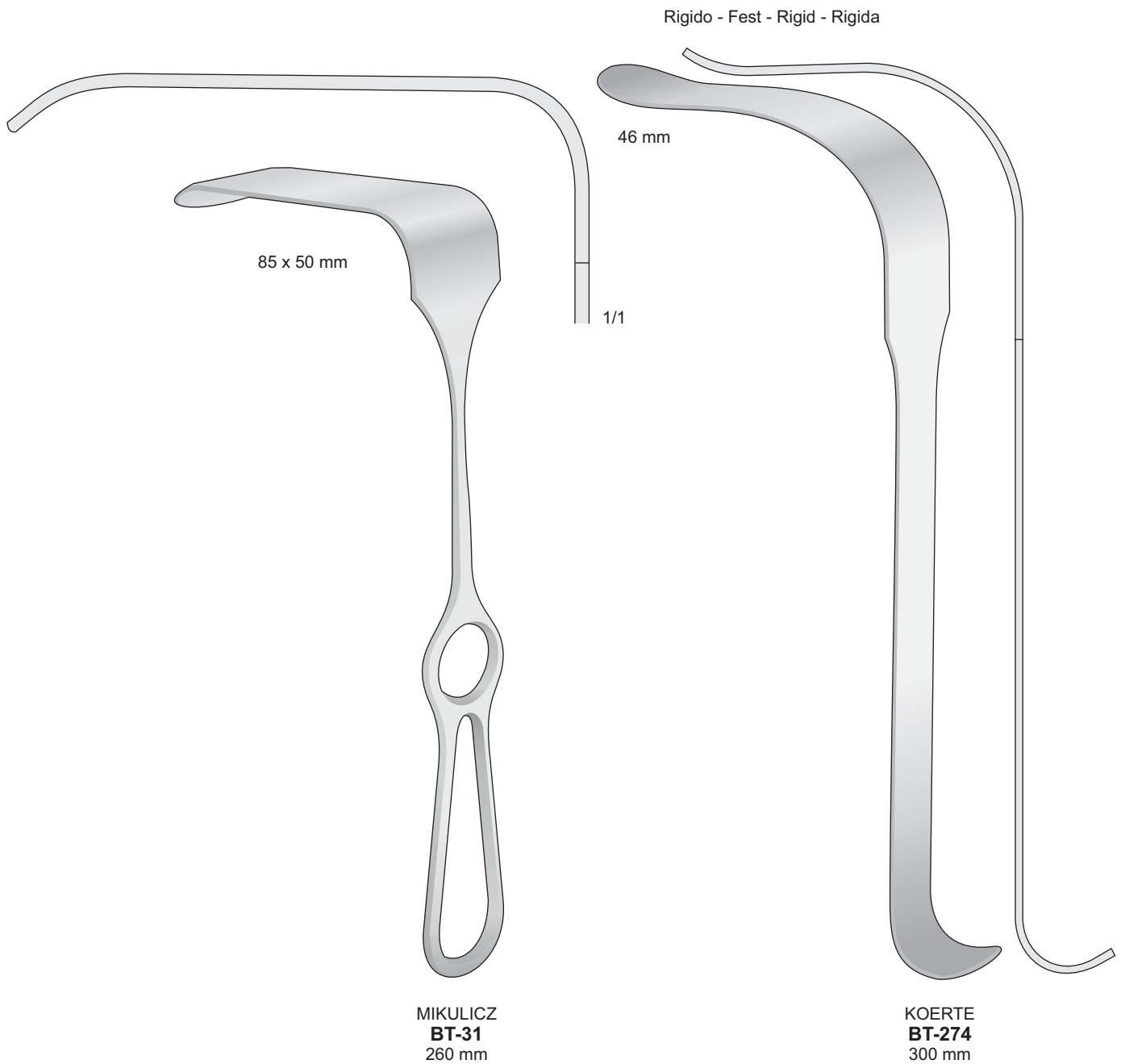
DEAVER  
**BT-167**  
300 mm

75 mm



DEAVER  
**BT-168**  
300 mm

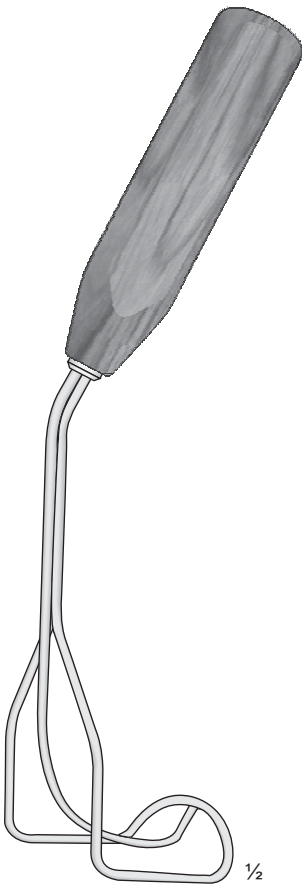






Destro  
Right  
Rechts  
Droite  
Derecha

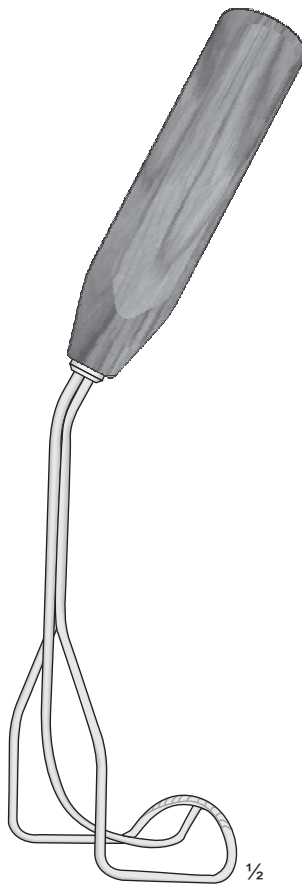
45 mm  
48 mm



COOLEY  
**BT-357**  
215 mm

Destro, leggermente dentallato  
Right, slightly serrated  
Rechts, mit zahnriefen  
Droite, légèrement dentelé  
Derecha, legermente dentados

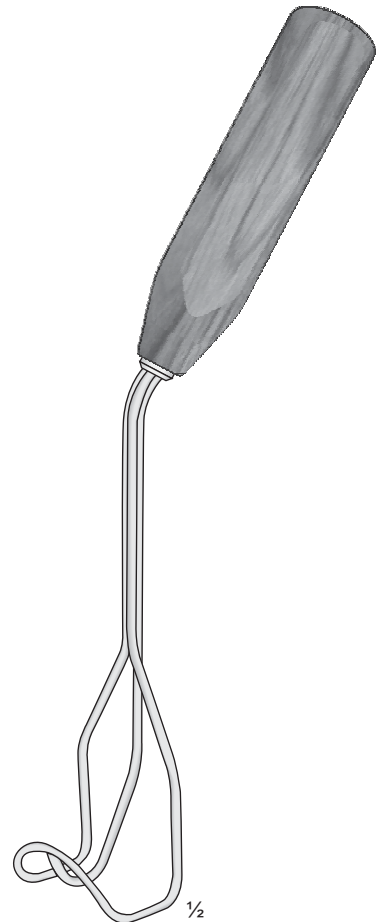
45 mm  
48 mm



COOLEY  
**BT-358**  
215 mm

Sinistro  
Left  
Links  
Gauche  
Izquierda

24 mm  
48 mm



COOLEY  
**BT-359**  
230 mm

**OM-85**

Set completo con 3 spatole  
Set complete with 3 spatulas  
Kompletset mit 3 Spatel  
Set complete avec 3 spatules  
Set completos con 3 espatulas

**OM-80 + OM-81 + OM-82**

Spatole addominali e intestinali inox  
Abdominal and intestinal spatulas  
Bauch und Darmspatel  
Ecarteurs abdominaux et intestinaux  
Espátulas abdominales e intestinales

Malleabili - Malleable - Biegsam  
Souples - Maleables

Spatole Inox malleabili antiriflesso nere  
Spatulas malleable black anodized

18 mm



22 mm

**OM-80**  
200 mm

14 mm



16 mm

**OM-81**  
200 mm

5 mm



8 mm

**OM-82**  
240 mm

18 mm



22 mm

**OM-87**  
200 mm

14 mm



16 mm

**OM-88**  
200 mm



Divaricatori

Retractors

Wundhaken

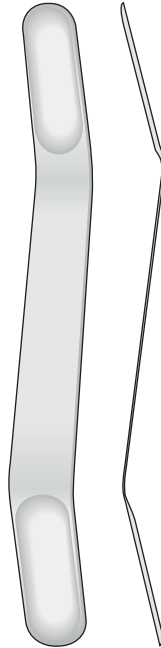
Ecarteurs

Separadores



<b>OM-201</b>	7 mm + 9 mm
<b>OM-202</b>	11 mm + 13 mm
<b>OM-203</b>	15 mm + 18 mm
<b>OM-204</b>	18 mm + 22 mm

CUSHING  
**OM-201/OM-204**  
180 mm



<b>OM-208</b>	7 mm + 9 mm
<b>OM-209</b>	11 mm + 13 mm
<b>OM-210</b>	15 mm + 18 mm
<b>OM-211</b>	18 mm + 22 mm

OLIVECRONA  
**OM-208/OM-211**  
180 mm

Malleabile - Malleable  
Biagsam - Souple - Maleable



**OM-101** 30 mm  
**OM-102** 40 mm  
**OM-103** 50 mm  
330 mm

Malleabile - Malleable  
Biagsam - Souple - Maleable



**HABERER**  
**OM-104**  
300 mm



**REVERDIN**  
**OM-105**  
285 mm

Malleabile - Malleable  
Biagsam - Souple - Maleable



**TUFFIER**  
**OM-99**  
200 mm





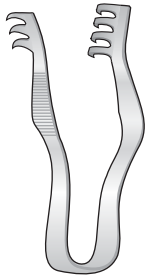
Divaricatori

Retractors

Wundhaken

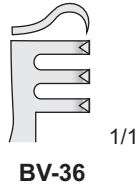
Ecarteurs

Separadores



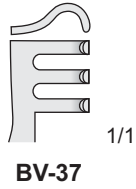
FINSEN  
BV-36/BV-39  
50 mm

Acuto  
Sharp  
Spitz  
Pointü  
Agudas



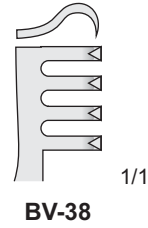
BV-36

Smusso  
Blunt  
Stumpf  
Mousse  
Romas



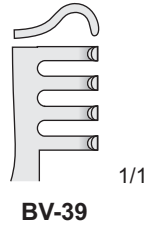
BV-37

Acuto  
Sharp  
Spitz  
Pointü  
Agudas

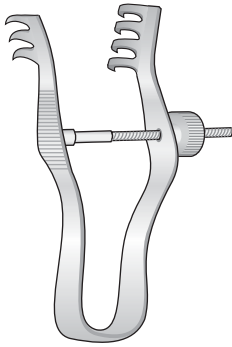


BV-38

Smusso  
Blunt  
Stumpf  
Mousse  
Romas

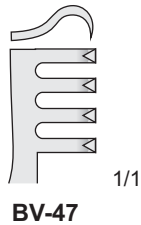


BV-39



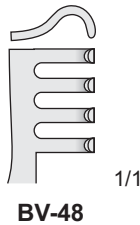
FINSEN  
BV-47/BV-48  
70 mm

Acuto  
Sharp  
Spitz  
Pointü  
Agudas

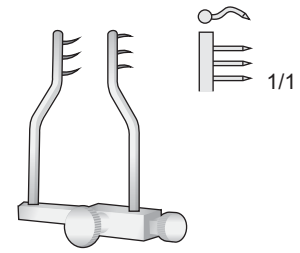


BV-47

Smusso  
Blunt  
Stumpf  
Mousse  
Romas



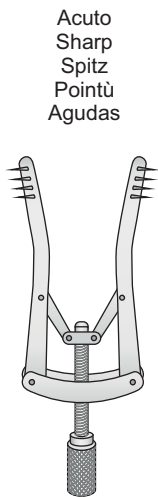
BV-48



LOGAN  
BV-45  
40 mm



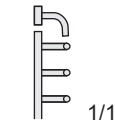
1/1



ALM  
BV-12  
70 mm

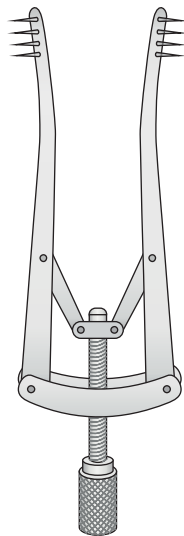
Acuto  
Sharp  
Spitz  
Pointü  
Agudas

Smusso  
Blunt  
Stumpf  
Mousse  
Romas



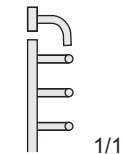
BV-12

70 mm



ALM  
BV-10  
100 mm

Acuto  
Sharp  
Spitz  
Pointü  
Agudas



BV-10

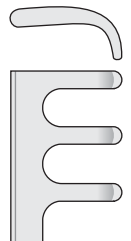
100 mm

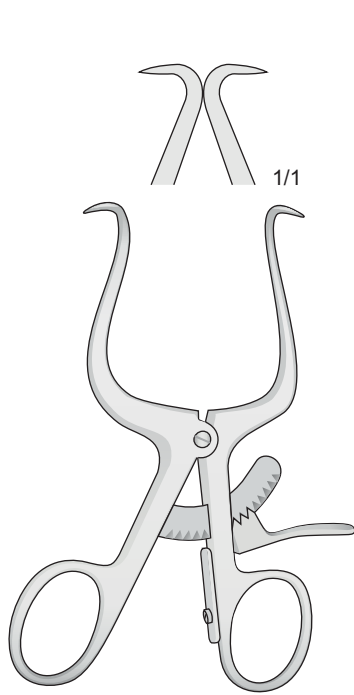


BV-08  
100 mm

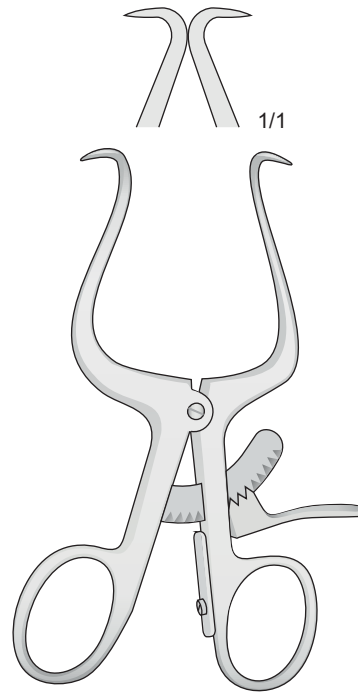
Smusso  
Blunt  
Stumpf  
Mousse  
Romas

Smusso  
Blunt  
Stumpf  
Mousse  
Romas

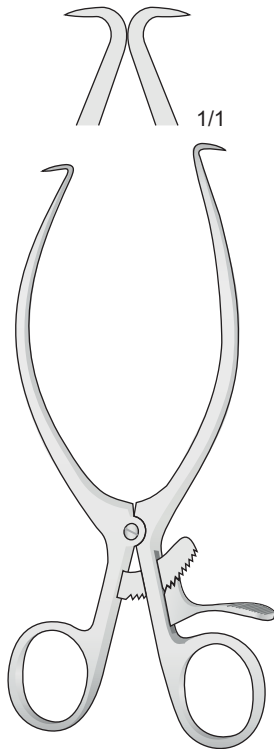




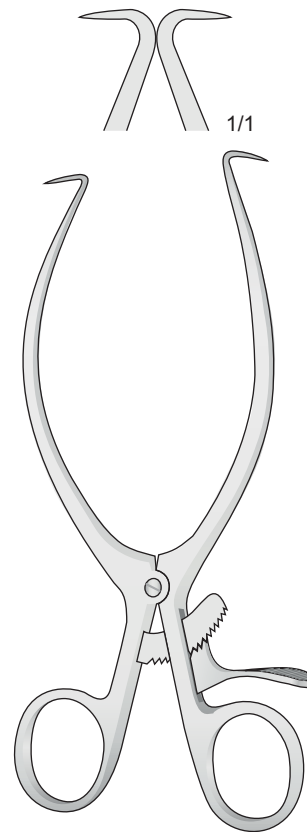
GELPI  
**BV-14**  
90 mm



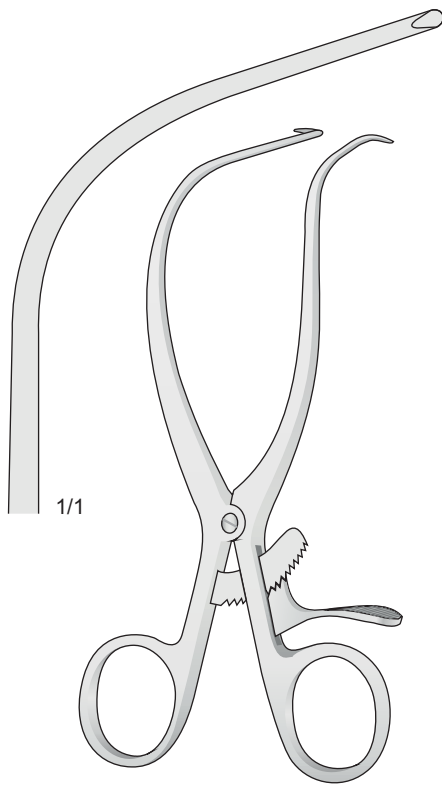
GELPI  
**BV-15**  
110 mm



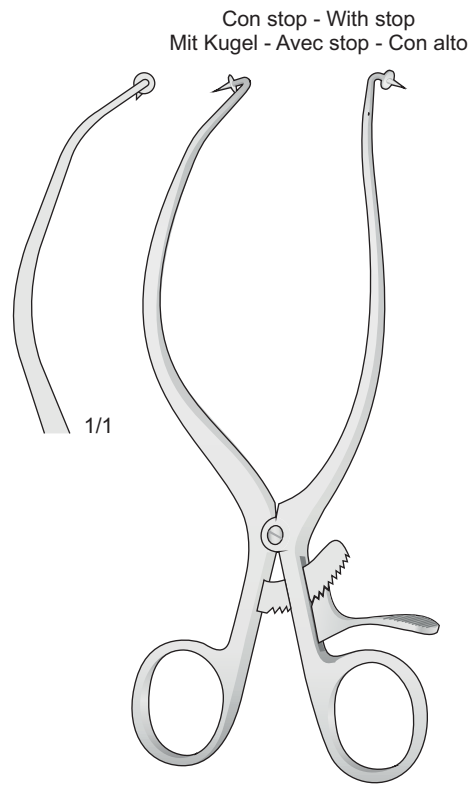
GELPI  
**BV-16**  
140 mm



GELPI  
**BV-17**  
180 mm

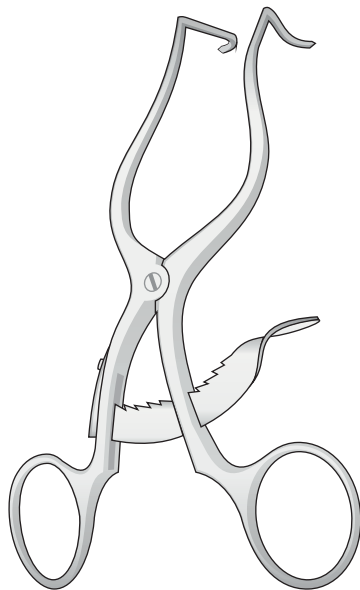


GELPI-SELETZ  
**BV-11**  
165 mm



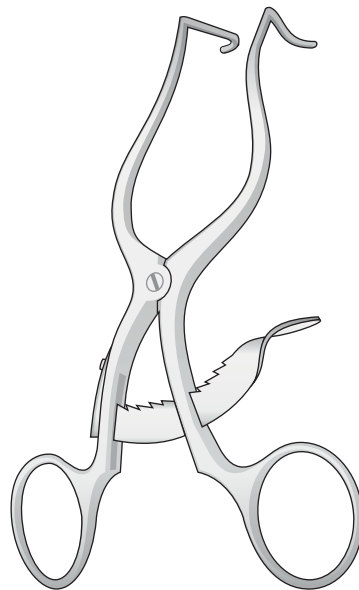
GELPI-LOKTITE  
**BV-13**  
190 mm

Acuto  
Scharp  
Spitz  
Pointu  
Agudo



CLOWARD-CONTOUR  
**BV-108**  
140 mm

Smusso  
Blunt  
Stumpf  
Mousse  
Romos



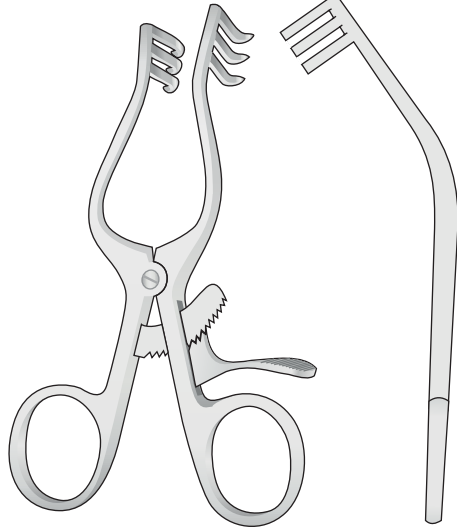
CLOWARD-CONTOUR  
**BV-109**  
140 mm



Acuto  
Sharp  
Spitz  
Pointu  
Agudo



1/1

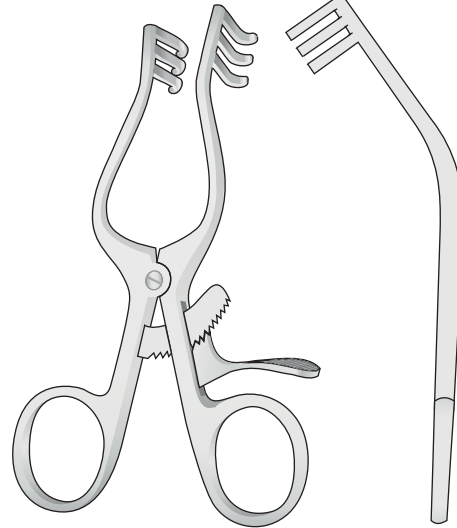


WULLSTEIN  
**BV-111**  
105 mm

Smusso  
Blunt  
Stumpf  
Mousse  
Romo



1/1

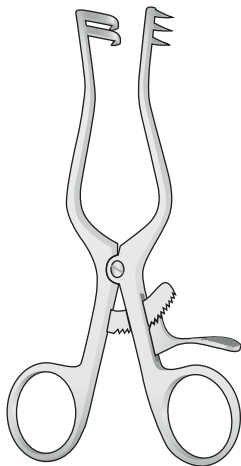


WULLSTEIN  
**BV-112**  
105 mm

Acuto  
Sharp  
Spitz  
Pointu  
Agudo



1/1

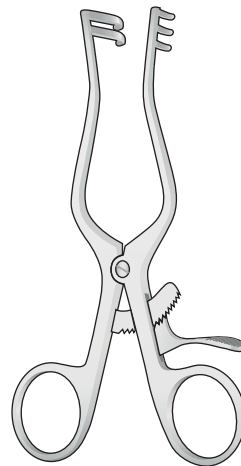


WEITLANER  
**BV-07**  
110 mm

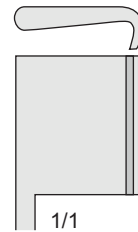
Smusso  
Blunt  
Stumpf  
Mousse  
Romo



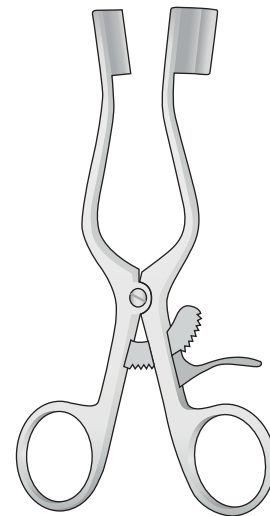
1/1



WEITLANER  
**BV-09**  
110 mm



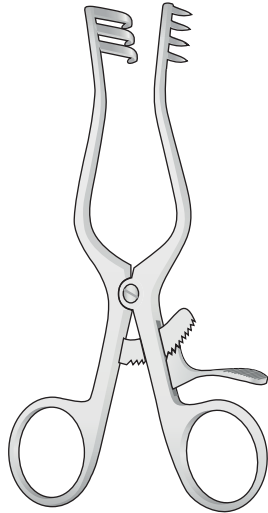
1/1



BABY-WEITLANER  
**BV-26**  
140 mm

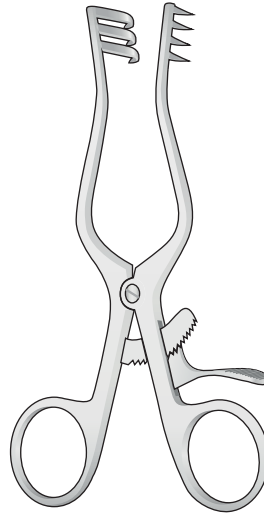


Semi acuto - Semi Sharp - Halbscharf  
Semi Pointu - Semi Agudas



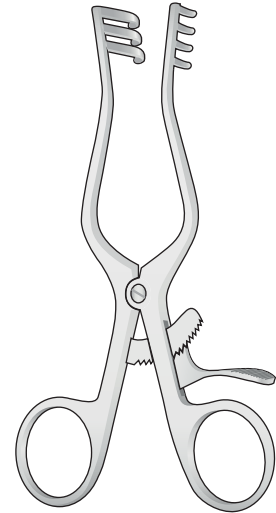
WEITLANER  
**BV-18**  
135 mm

Acuto - Sharp - Spitz  
Pointu - Agudas



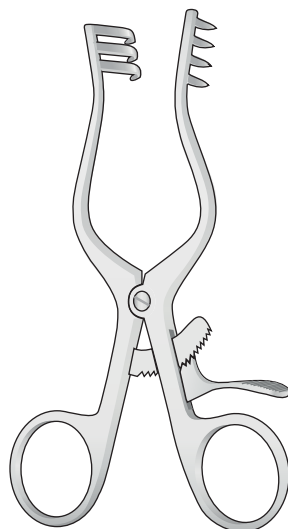
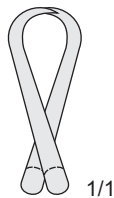
WEITLANER  
**BV-20**  
135 mm

Smusso - Blunt - Stumpf  
Mousse - Romas



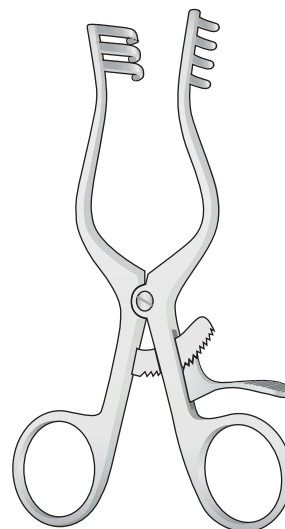
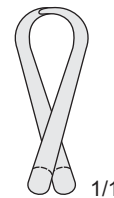
WEITLANER  
**BV-22**  
135 mm

Acuto - Sharp - Spitz  
Pointu - Agudas



WEITLANER  
**BV-55**  
135 mm

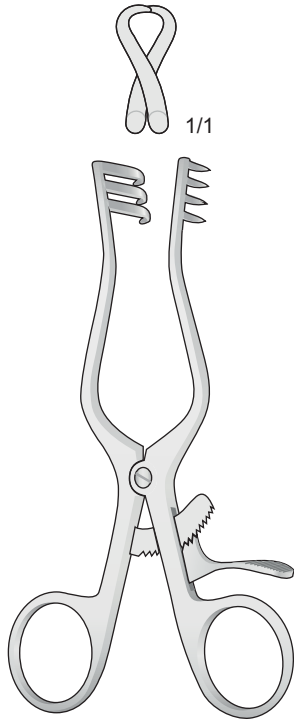
Smusso - Blunt - Stumpf  
Mousse - Romas



WEITLANER  
**BV-56**  
135 mm

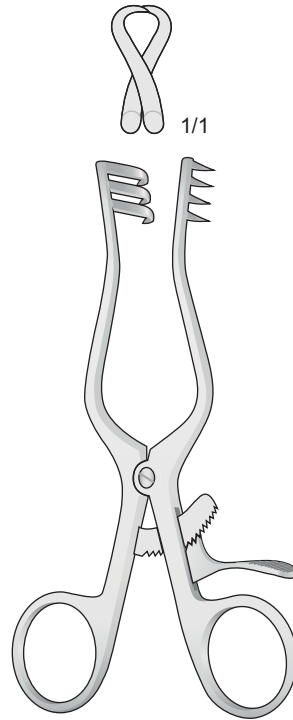


Semi acuto - Sharp - Halbscharf  
Semi Pointu - Agudas



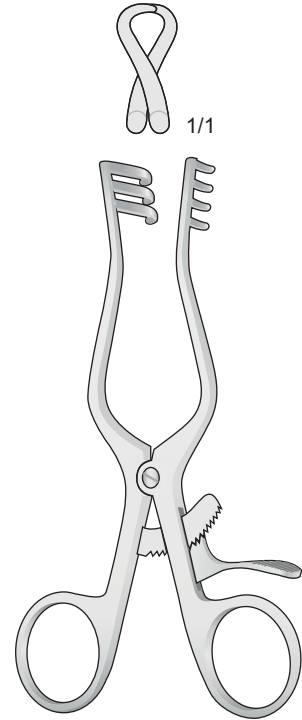
WEITLANER  
**BV-19**  
165 mm

Acuto - Sharp - Spitz  
Pointu - Agudas



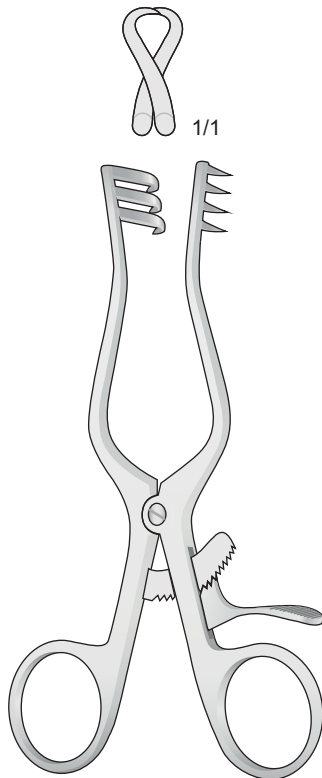
WEITLANER  
**BV-21**  
165 mm

Smusso - Blunt - Stumpf  
Mousse - Romas



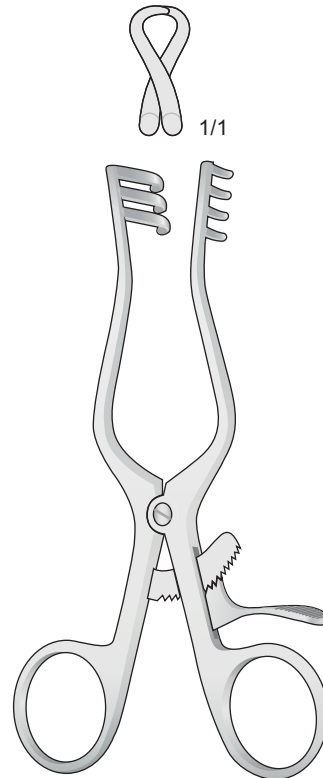
WEITLANER  
**BV-23**  
165 mm

Acuto - Sharp - Spitz  
Pointu - Agudas



WEITLANER  
**BV-24**  
200 mm

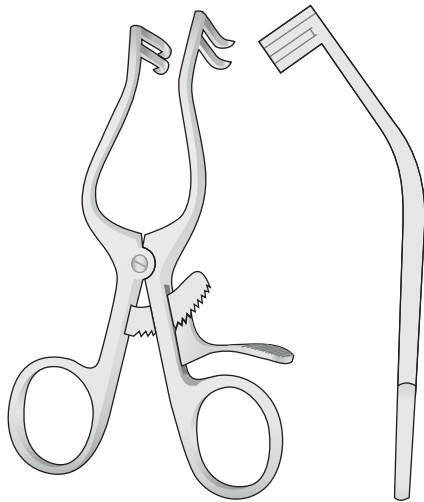
Smusso - Blunt - Stumpf  
Mousse - Romas



WEITLANER  
**BV-25**  
200 mm

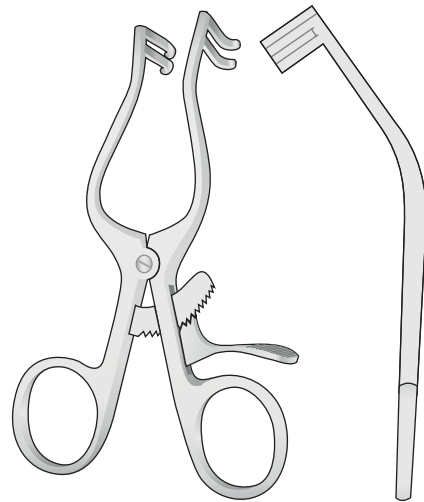


Acuto - Sharp - Spitz  
Pointu - Agudas



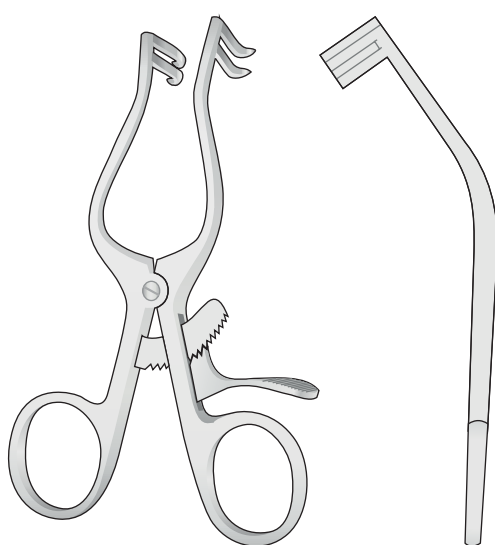
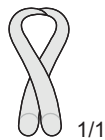
PLESTER  
**BV-90**  
110 mm

Smusso - Blunt - Stumpf  
Mousse - Romas



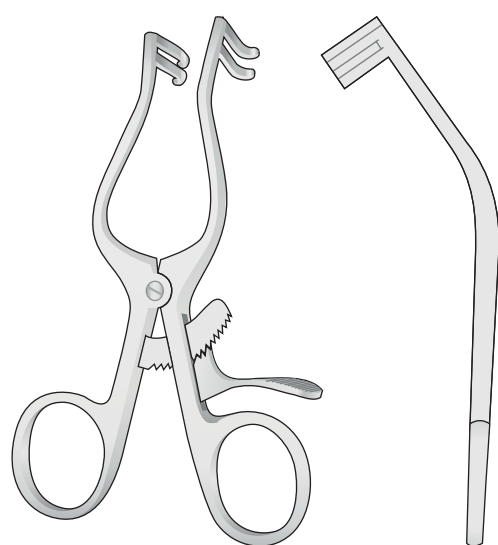
PLESTER  
**BV-91**  
110 mm

Acuto - Sharp - Spitz  
Pointu - Agudas



PLESTER  
**BV-92**  
135 mm

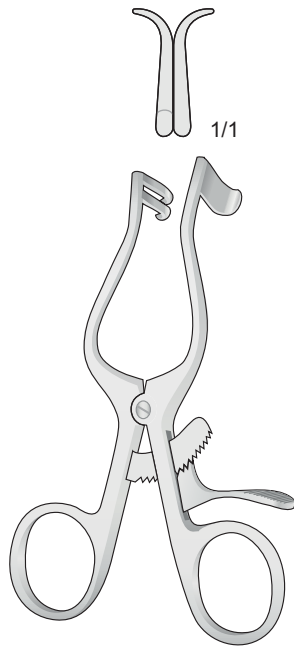
Smusso - Blunt - Stumpf  
Mousse - Romas



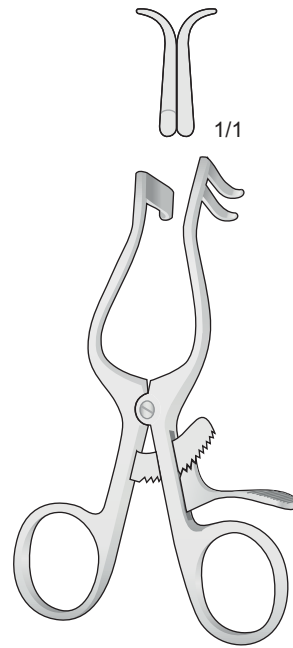
PLESTER  
**BV-93**  
135 mm



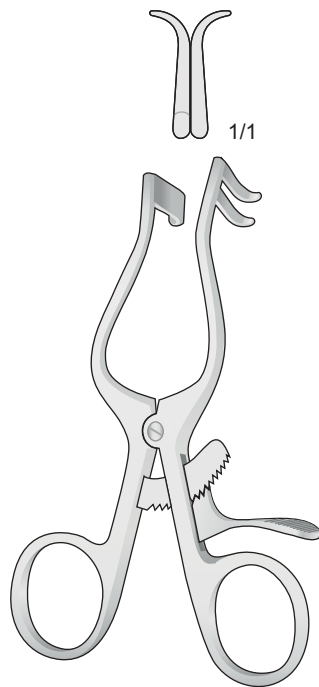
Smusso - Blunt - Stumpf - Mousse - Rome



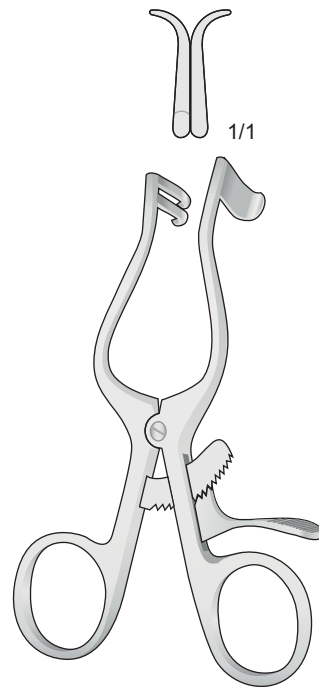
PLESTER  
**BV-94**  
110 mm



PLESTER  
**BV-95**  
110 mm

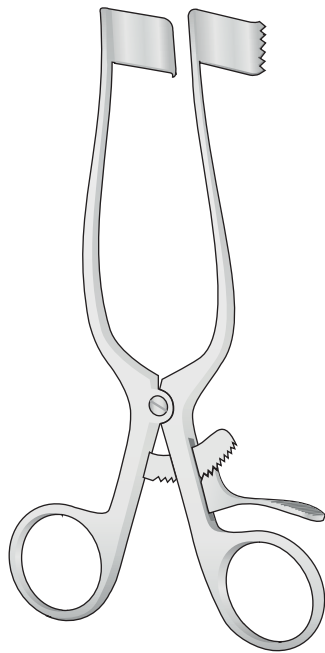


PLESTER  
**BV-96**  
135 mm



PLESTER  
**BV-97**  
135 mm

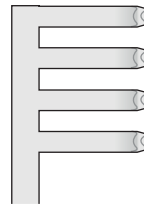
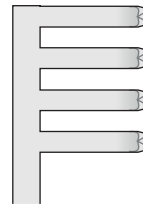




MEYERDING  
**BV-76** - 32 x 25 mm  
**BV-77** - 60 x 25 mm  
**BV-78** - 54 x 25 mm  
**BV-79** - 60 x 20 mm  
 180 mm

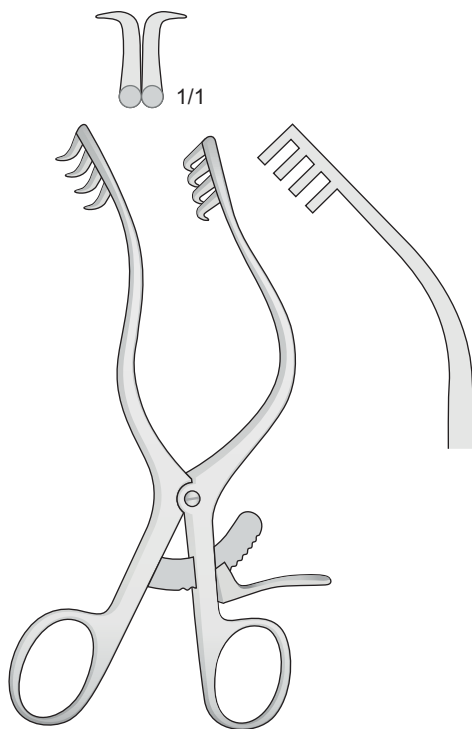
Acuto - Sharp - Spitz  
 Pointu - Agudo

Smusso - Blunt - Stumpf  
 Mousse - Rome

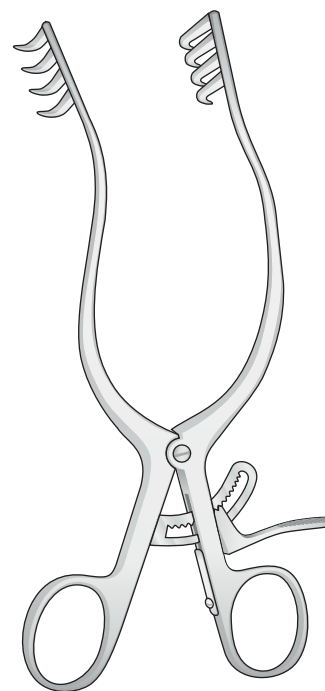


**BV-117**

**BV-118**



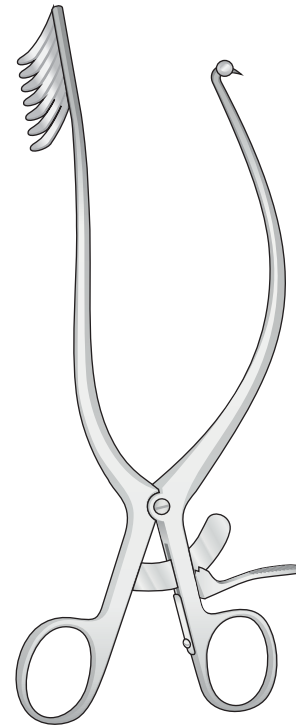
MOLLISON  
**BV-110**  
 160 mm



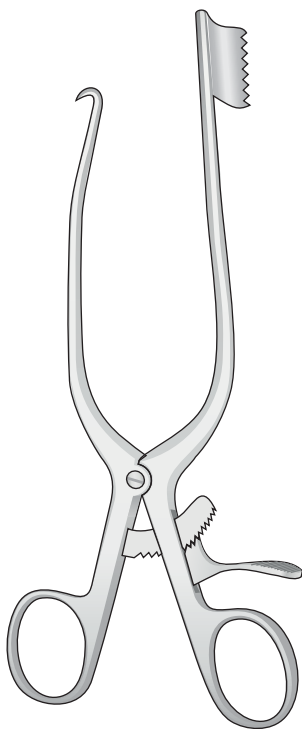
ANDERSON-ADSON  
**BV-117/BV-118**  
 200 mm



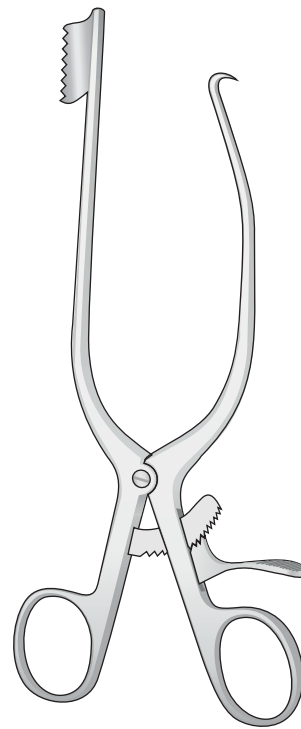
WALTON  
**BV-88**  
180 mm



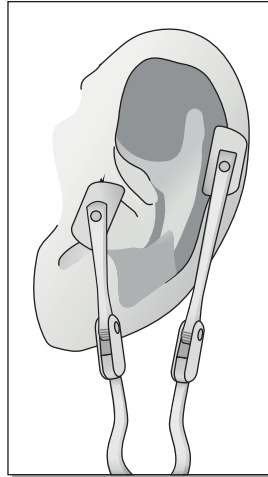
WALTON  
**BV-89**  
180 mm



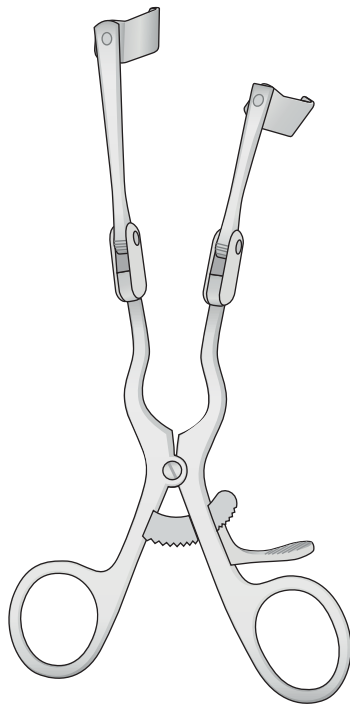
MARKHAM-MEYERDING  
**BV-98**  
180 mm



MARKHAM-MEYERDING  
**BV-99**  
180 mm

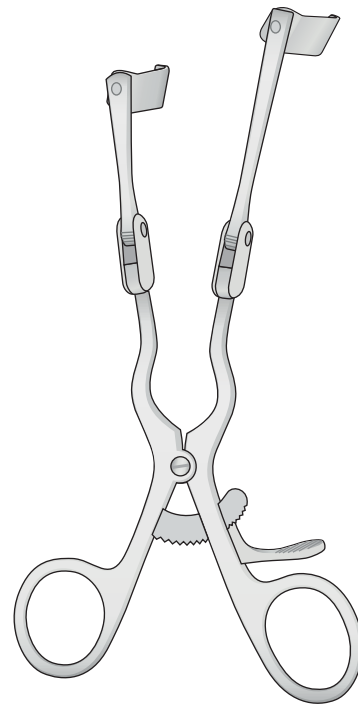


Lame, sinistro  
Blades, left  
Klingen, Link  
Lames, gauche  
Hojas, izquierda  
13 x 20 mm



**DOLWICK-REICH**  
**BV-101**  
170 mm

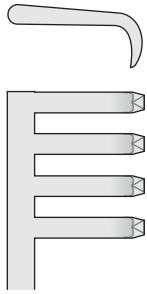
Lame, destro  
Blades, right  
Klingen, Rechts  
Lames, droite  
Hojas, derecha  
13 x 20 mm



**DOLWICK-REICH**  
**BV-102**  
170 mm

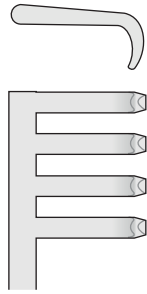


Acuto - Sharp - Spitz  
Pointu - Agudo



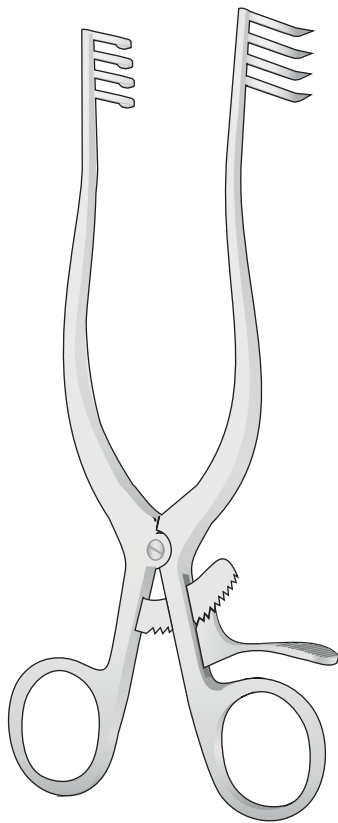
**BV-119**

Smusso - Blunt - Stumpf  
Mousse - Rome



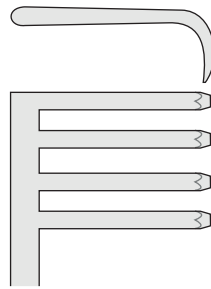
**BV-120**

4 x 4 Denti  
4 x 4 Teeth  
4 x 4 Zähne  
4 x 4 Dents  
4 x 4 Dientes



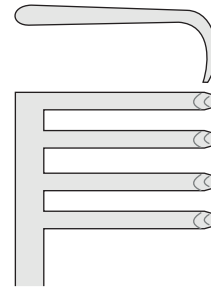
**ADSON  
BV-119/BV-120  
200 mm**

Acuto - Sharp - Spitz  
Pointu - Agudo



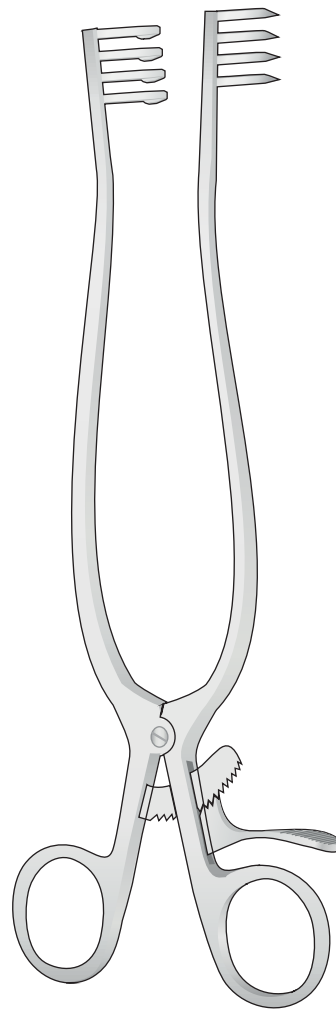
**BV-27**

Smusso - Blunt - Stumpf  
Mousse - Rome

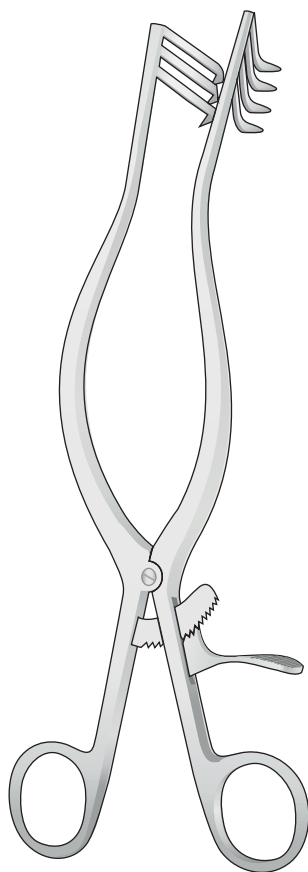


**BV-28**

4 x 4 Denti  
4 x 4 Teeth  
4 x 4 Zähne  
4 x 4 Dents  
4 x 4 Dientes



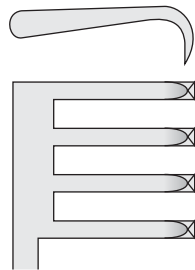
**WEITLANER  
BV-27/BV-28  
250 mm**



ADSON  
BV-190/BV-193  
265 mm

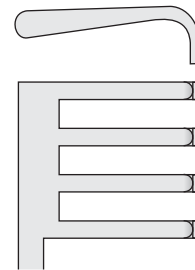
3 x 4 Denti  
3 x 4 Teeth  
3 x 4 Zähne  
3 x 4 Dents  
3 x 4 Dientes

Acuto  
Sharp  
Spitz  
Pointü  
Agudas



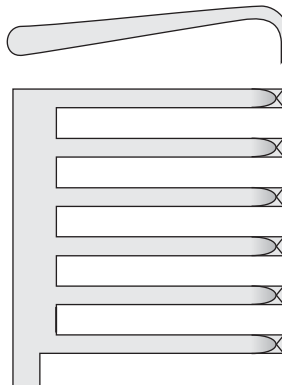
BV-190

Smusso  
Blunt  
Stumpf  
Mousse  
Romos

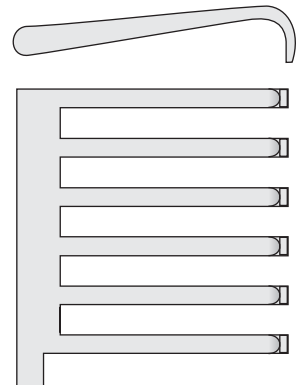


BV-191

6 x 6 Denti  
6 x 6 Teeth  
6 x 6 Zähne  
6 x 6 Dents  
6 x 6 Dientes



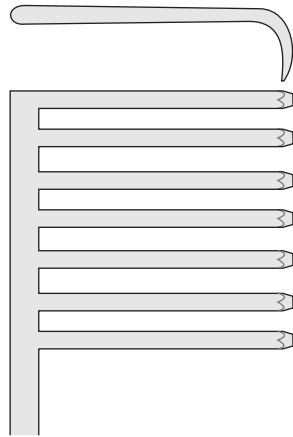
BV-192



BV-193

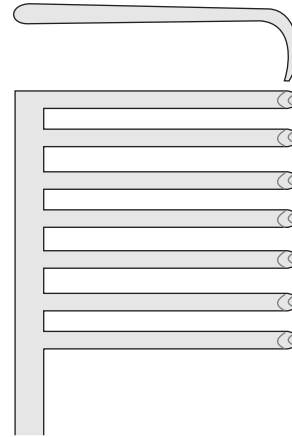


Acuto - Sharp - Spitz  
Pointu - Agudo



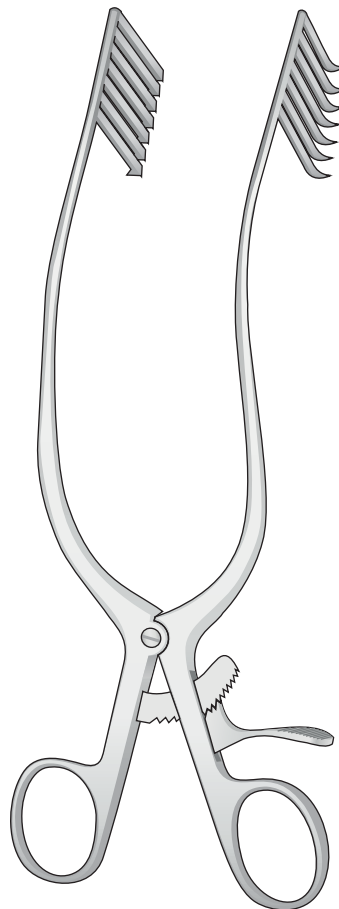
**BV-130**  
220 mm

Smusso - Blunt - Stumpf  
Mousse - Rome



**BV-131**  
220 mm

7 x 7 Denti  
7 x 7 Teeth  
7 x 7 Zähne  
7 x 7 Dents  
7 x 7 Dientes

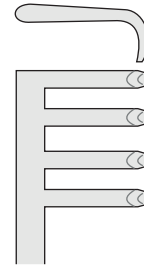
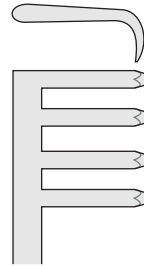


MISKIMON  
**BV-130/BV-131**  
220 mm



Acuto  
Scharp  
Spitz  
Pointu  
Agudo

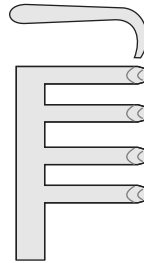
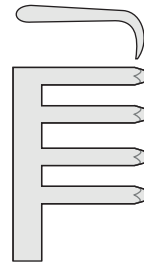
Smusso  
Blunt  
Stumpf  
Mousse  
Romos



**BV-68**  
140 mm

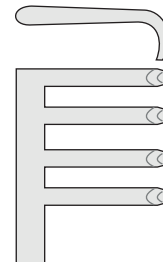
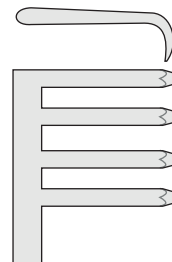
**BV-70**  
140 mm

3 x 4 Denti  
3 x 4 Teeth  
3 x 4 Zähne  
3 x 4 Dents  
3 x 4 Dientes



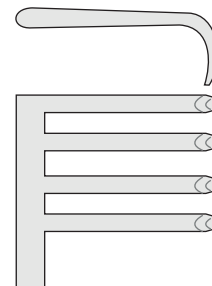
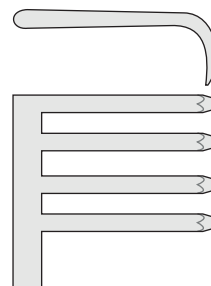
**BV-69**  
165 mm

**BV-71**  
165 mm



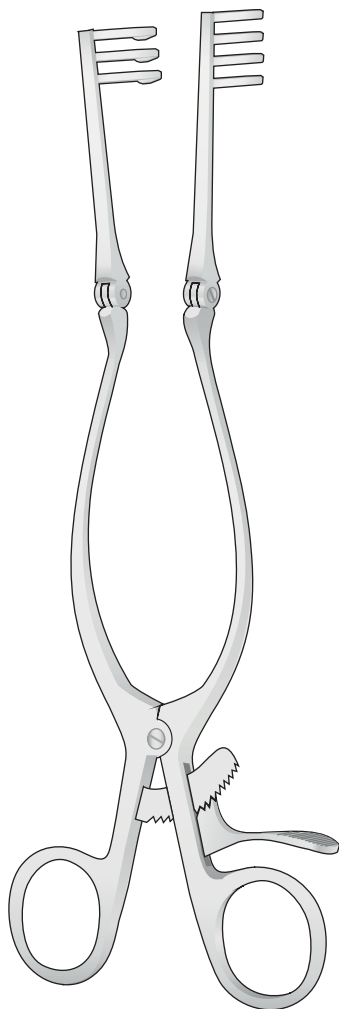
**BV-72**  
200 mm

**BV-73**  
200 mm



**BV-74**  
250 mm

**BV-75**  
250 mm

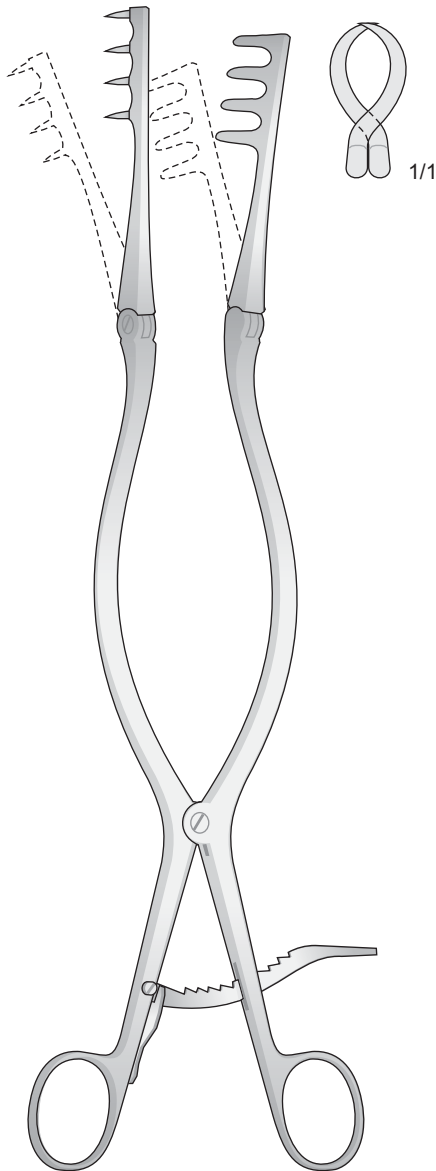


ADSON  
**BV-68/BV-75**

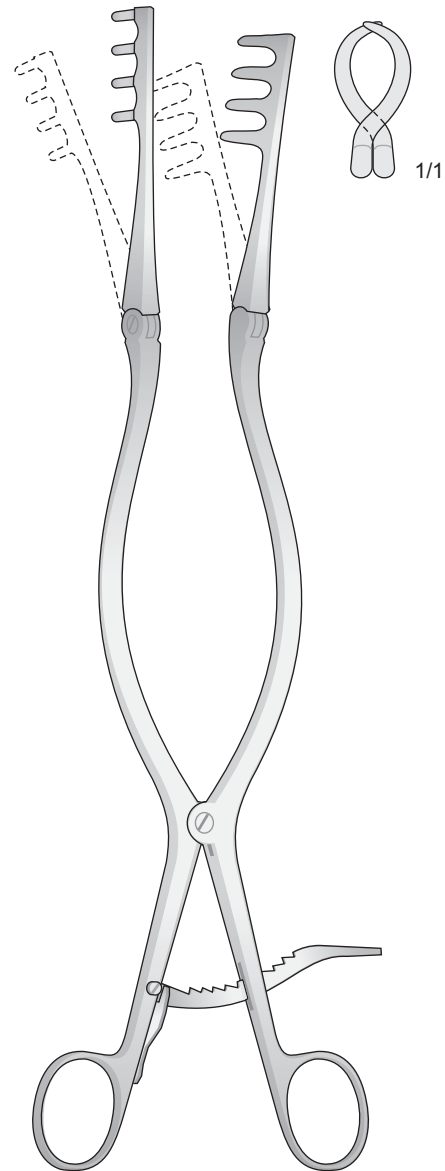


Acuto - Sharp  
Spitz - Pointu  
Agudas  
4 x 4 Denti  
4 x 4 Teeth  
4 x 4 Zähne  
4 x 4 Dents  
4 x 4 Dientes

Semi acuto -Sharp  
Halbscharf - Semi pointu  
Agudas  
4 x 4 Denti  
4 x 4 Teeth  
4 x 4 Zähne  
4 x 4 Dents  
4 x 4 Dientes



BECKMANN  
**BV-121**  
310 mm



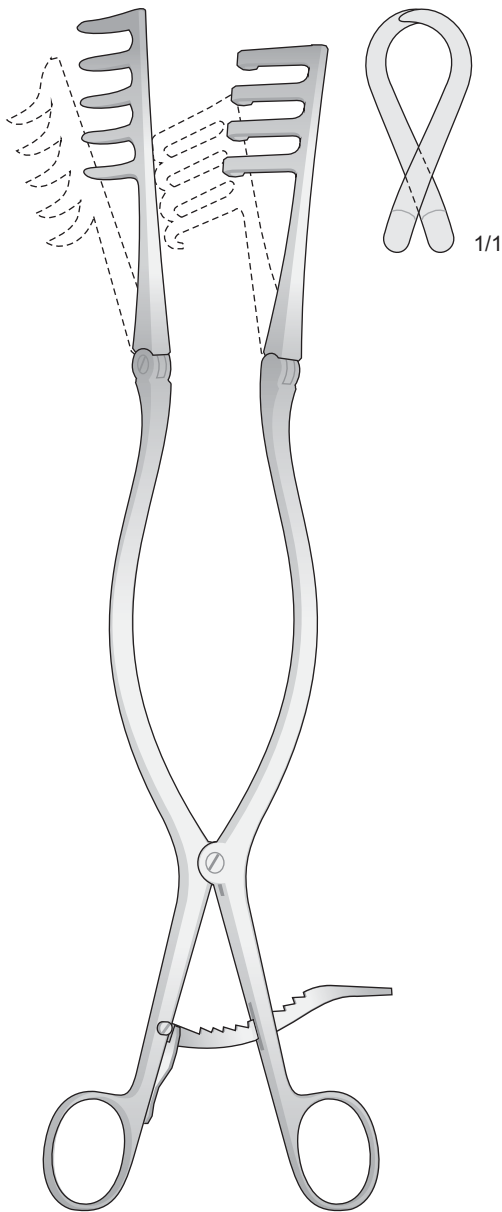
BECKMANN  
**BV-122**  
310 mm





Smusso - Blunt - Stumpf  
Mousse - Romas

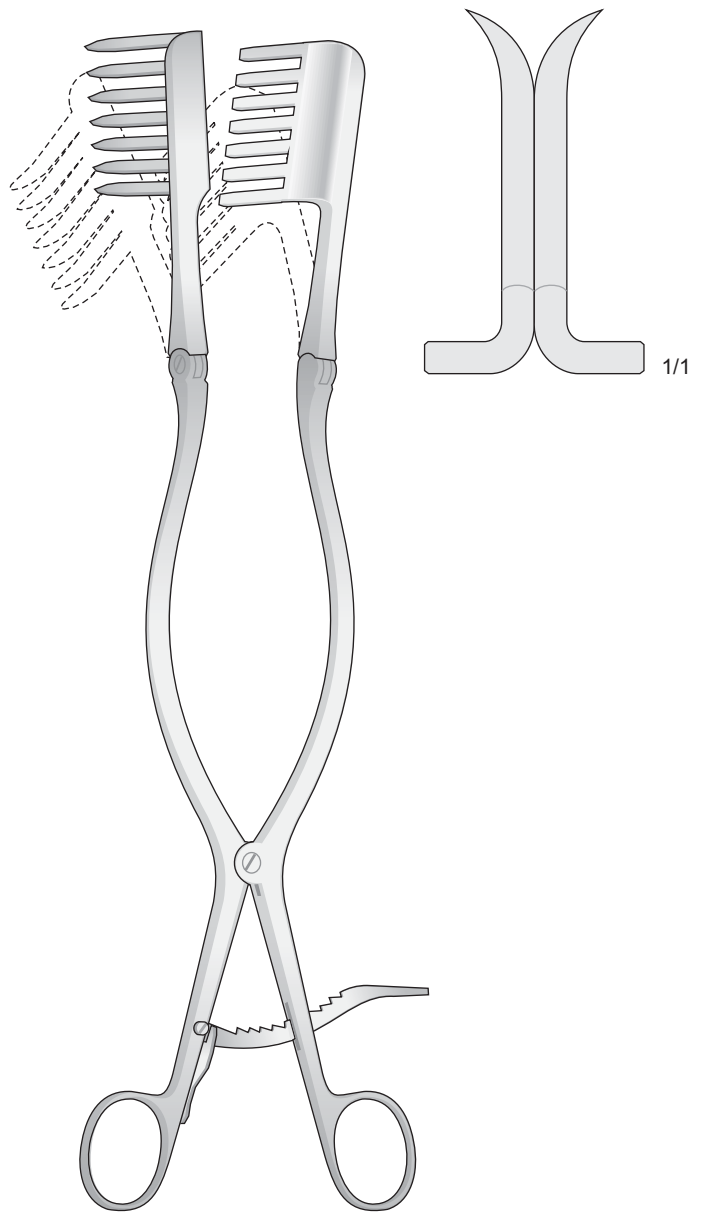
5 x 4 Denti  
5 x 4 Teeth  
5 x 4 Zähne  
5 x 4 Dents  
5 x 4 Dientes



ADSON  
BV-123  
320 mm

Acuto-Sharp-Spitz  
Pointú-Agudas

7 x 7 Denti  
7 x 7 Teeth  
7 x 7 Zähne  
7 x 7 Dents  
7 x 7 Dientes



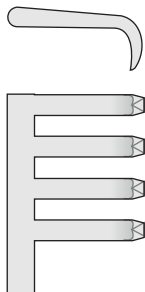
BECKMANN-EATON  
BV-124  
330 mm



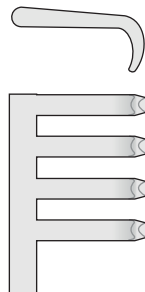
Solo divaricatore senza valva  
Retractor without blades  
Spreizer allein  
Separador sin valvas  
Ecarteur sans valves

Acuto  
Sharp  
Spitz  
Pointù  
Agudas

Smusso  
Blunt  
Stumpf  
Mousse  
Romas

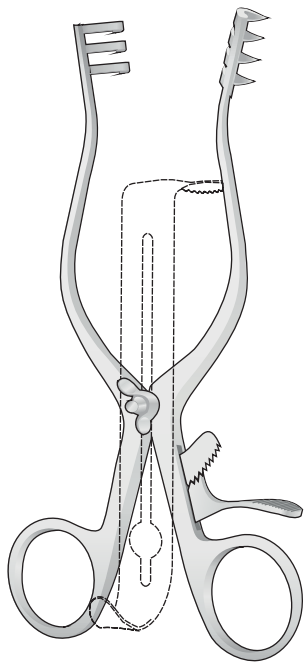


**BV-135**



**BV-136**

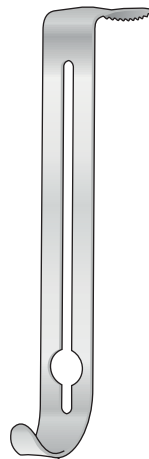
3 x 4 Denti  
3 x 4 Teeth  
3 x 4 Zähne  
3 x 4 Dents  
3 x 4 Dientes



**HENLEY  
BV-135/BV-136  
165 mm**

Valve centrali  
Center blades  
Mittelblatt  
Valves centrale  
Valvas centrales

Fig. 1



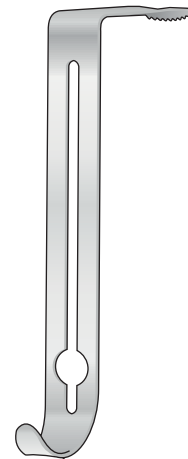
**BV-137  
16x19 mm**

Fig. 2



**BV-138  
16x25 mm**

Fig. 3

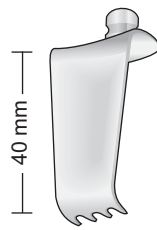


**BV-139  
16x32 mm**



CLOWARD Modif.  
**BV-319**  
 Divaricatore, solo  
 Retractor, only  
 Sperrer, allein  
 Ecarteur, seul  
 Separador, suelto

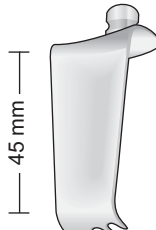
CLOWARD Modif.  
**BV-317**  
 Divaricatore, solo  
 Retractor, only  
 Sperrer, allein  
 Ecarteur, seul  
 Separador, suelto



40 mm

16 mm

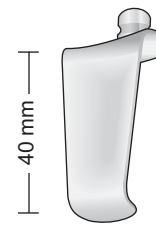
**BV-321**



45 mm

16 mm

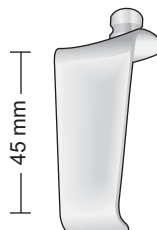
**BV-322**



40 mm

16 mm

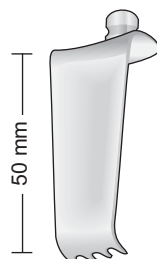
**BV-326**



45 mm

16 mm

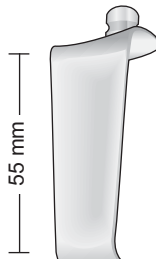
**BV-327**



50 mm

16 mm

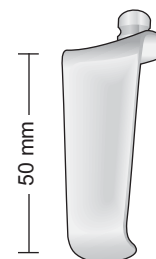
**BV-323**



55 mm

16 mm

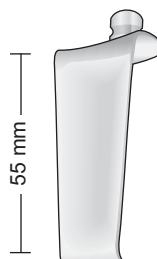
**BV-324**



50 mm

16 mm

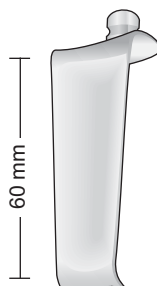
**BV-328**



55 mm

16 mm

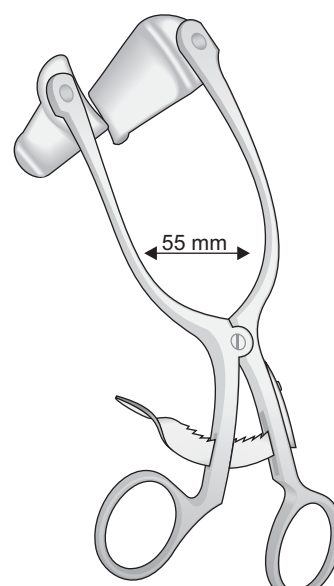
**BV-329**



60 mm

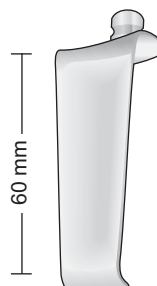
16 mm

**BV-325**



55 mm

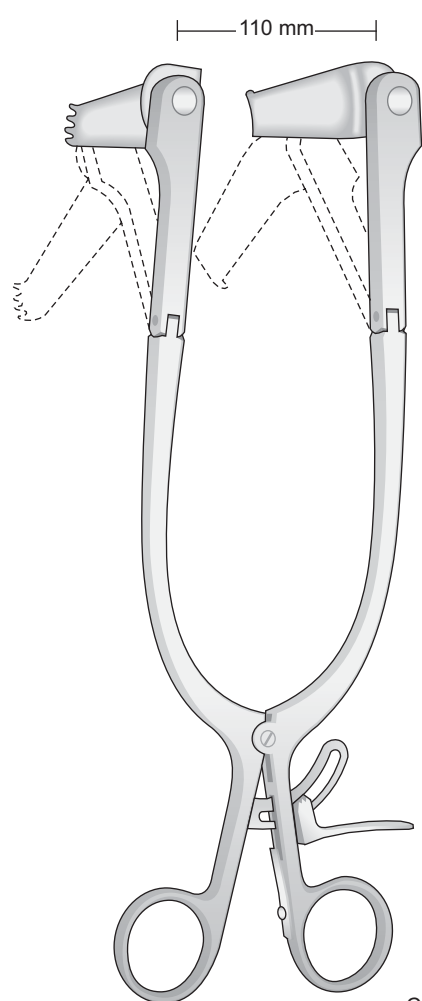
**CLOWARD BV-318**  
160 mm



60 mm

16 mm

**BV-330**



**CLOWARD modif. BV-320**  
250 mm

Completo di 5 valve  
 Complete with 5 blades  
 Komplett mit 5 Valven  
 Complet avec 5 valves  
 Completo con 5 valvas

Completo di 5 valve  
 Complete with 5 blades  
 Komplett mit 5 Valven  
 Complet avec 5 valves  
 Completo con 5 valvas

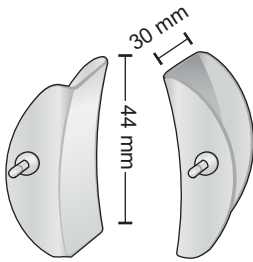


**BV-141**

Completo con un paio di valve  
 Complete with 1 pairs of blades  
 Komplett mit 1 Paar Valven  
 Complete avec 1 paires de valves  
 Completos con 1 pares de valvas

**BV-146**

Completo con due paia di valve  
 Complete with 2 pairs of blades  
 Komplett mit 2 paar valven  
 Complete avec 2 paires de valves  
 Completos con 2 pares de valvas



**BV-142** 20x44 mm  
**BV-143** 30x44 mm  
 Valve laterali - paia  
 Lateral blades - pairs  
 Seitl. Blätter - paar  
 Valves latérales - paires  
 Valvas laterales - pares

**BV-145**

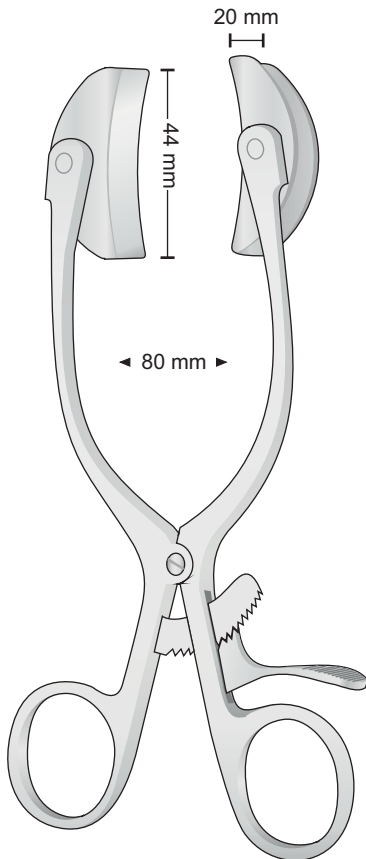
Completo con un paio di valve  
 Complete with 1 pairs of blades  
 Komplett mit 1 Paar Valven  
 Complete avec 1 paires de valves  
 Completos con 1 pares de valvas

**BV-148**

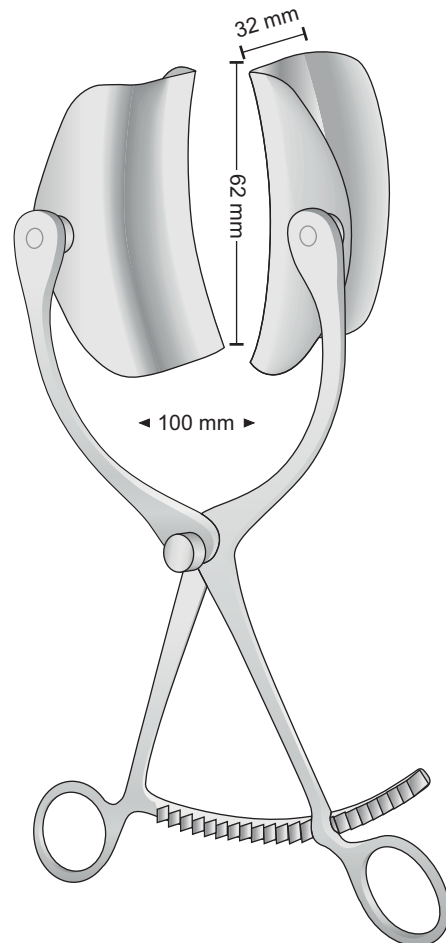
Divaricatore solo  
 Retractor only  
 Sperrer allein  
 Ecarteur seul  
 Separador suelto

**BV-372**

32x62 mm  
 Valve laterali - paia  
 Lateral blades - pairs  
 Seitl.blätter - paar  
 Valves latérales - paires  
 Valvas laterales - pares



BABY-COLLIN  
**BV-141**  
 180 mm



COLLIN  
**BV-145**  
 220 mm



**COLLIN  
BV-380**  
Completo - Complete  
Komplett - Complets - Completos  
**BV-378 ÷ BV-375 ÷ BV-372**

**COLLIN  
BV-381**  
Completo - Complete  
Komplett - Complets - Completos  
**BV-379 ÷ BV-376 ÷ BV-373**

**COLLIN  
BV-382**  
Completo - Complete  
Komplett - Complets - Completos  
**BV-379 ÷ BV-377 ÷ BV-374**

**BV-378**  
Allargatore solo  
Spreader only  
Sperrer allein  
Ecarteur seul  
Separador suelto

**BV-379**  
Allargatore solo  
Spreader only  
Sperrer allein  
Ecarteur seul  
Separador suelto

**BV-379**  
Allargatore solo  
Spreader only  
Sperrer allein  
Ecarteur seul  
Separador suelto

**BV-375**  
Valva centrale  
Center blade  
Mittelblatt  
Valve centrale  
Valva central  
55 x 55 mm

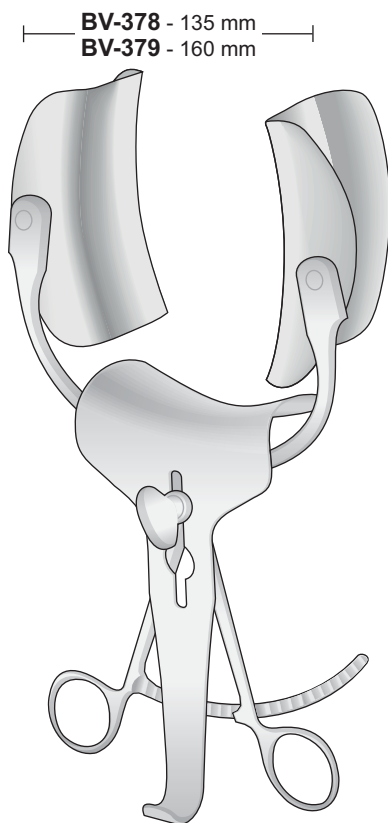
**BV-376**  
Valva centrale  
Center blade  
Mittelblatt  
Valve centrale  
Valva central  
55 x 65 mm

**BV-377**  
Valva centrale  
Center blade  
Mittelblatt  
Valve centrale  
Valva central  
55 x 75 mm

**BV-372**  
Valve laterali  
Lateral blades  
Seitliche Blätter  
Valves latérales  
Valvas laterales  
32 x 62 mm

**BV-373**  
Valve laterali  
Lateral blade  
Seitliche Blätter  
Valves latérales  
Valvas laterales  
38 x 80 mm

**BV-374**  
Valve laterali  
Lateral blade  
Seitliche Blätter  
Valves latérales  
Valvas laterales  
38 x 100 mm



Unità di vendita delle valve: paio  
Sales Unit of blades: pair  
Bestelleinheit der Blätter: Paar  
Unité de commande pour les valves: paire

**COLLIN  
BV-380 - BV-381 - BV-382**  
Completo - Complete  
Komplett - Complets - Completos



COLLIN  
**BV-370**  
Completo - Complete  
Komplett - Complets - Completos  
**BV-369 ÷ BV-368 ÷ BV-366**

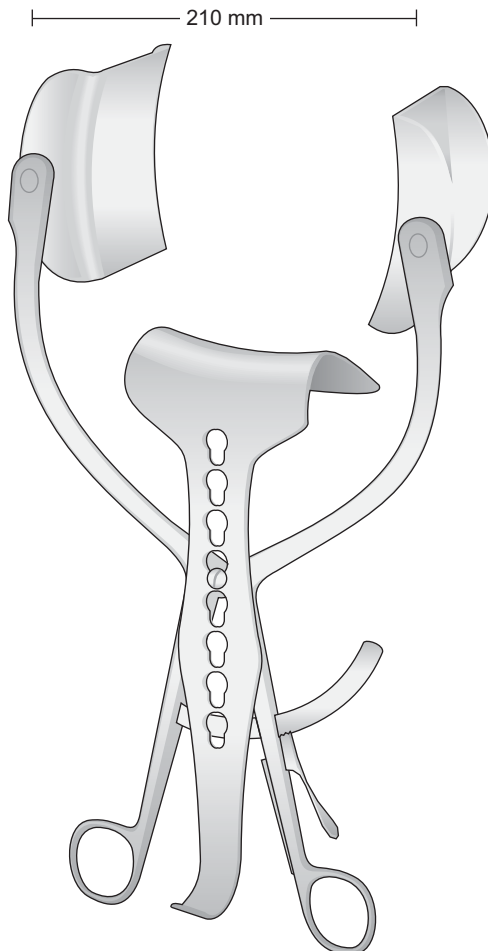
COLLIN  
**BV-371**  
Completo - Complete  
Komplett - Complets - Completos  
**BV-369 ÷ BV-368 ÷ BV-367**

**BV-366**  
Valve laterali  
Lateral blades  
Seitliche Blätter  
Valves latérales  
Valvas laterales  
50 x 58 mm

**BV-367**  
Valve laterali  
Lateral blades  
Seitliche Blätter  
Valves latérales  
Valvas laterales  
62 x 80 mm

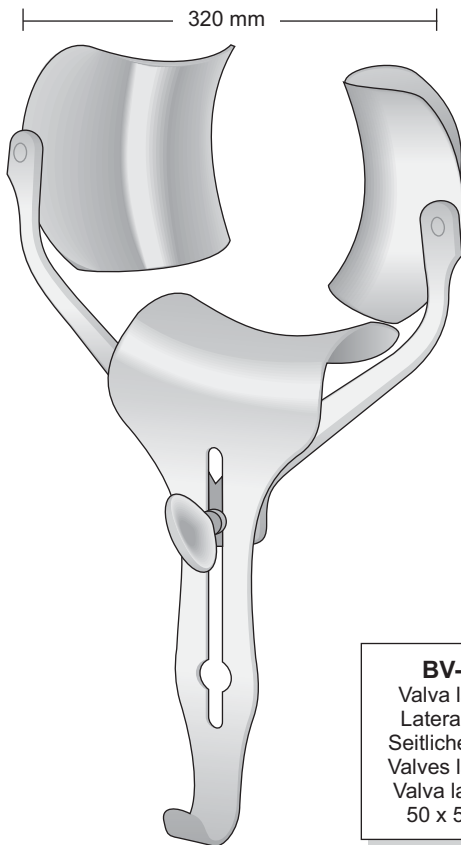
**BV-368**  
Valva centrale  
Center blade  
Mittelblatt  
Valve centrale  
Valva central  
62 x 70 mm

**BV-369**  
Allargatore solo  
Spreader only  
Sperrer allein  
Ecarteur seul  
Separador suelto



Unità di vendita delle valve: paio  
Sales Unit of blades: pair  
Bestelleinheit der Blätter: Paar  
Unité de commande pour les valves: paire

COLLIN  
**BV-370/BV-371**  
Completo - Complete  
Komplett - Complets - Completos



**RICARD  
BV-199**  
Completo - Complete  
Komplett - Complet - Completo  
**BV-194 + BV-195 + BV-197**

**RICARD  
BV-200**  
Completo - Complete  
Komplett - Complet - Completo  
**BV-194 + BV-196 + BV-198**

**BV-194**  
Divaricatore solo  
Retractor only  
Sperrer allein  
Ecarteur seul  
Separador suelto

**BV-195**  
Valva centrale  
Center blade  
Mittelblatt  
Valve centrale  
Valva central  
55 x 70 mm

**BV-196**  
Valva centrale  
Center blade  
Mittelblatt  
Valve centrale  
Valva central  
80 x 90 mm

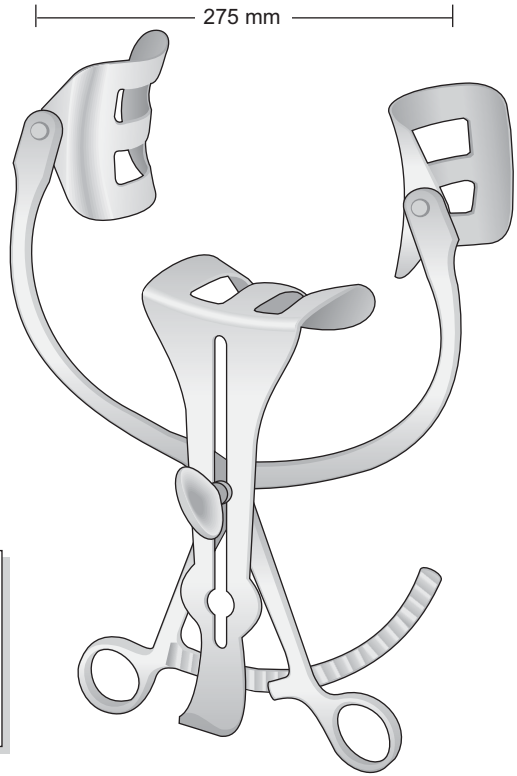
**BV-183**  
Valva laterale  
Lateral blade  
Seitliche Blätter  
Valves latérales  
Valva laterales  
50 x 58 mm

**BV-197**  
Valva laterale  
Lateral blade  
Seitliche Blätter  
Valves latérales  
Valva laterales  
60 x 80 mm

**BV-198**  
Valva laterale  
Lateral blade  
Seitliche Blätter  
Valves latérales  
Valva laterales  
72 x 85 mm

**RICARD**  
**BV-199** Completo - Complete  
Komplett - Complet - Completo  
**BV-200** Completo - Complete  
Komplett - Complet - Completo

Unità di vendita delle valve: paio  
Sales Unit of blades: pair  
Bestelleinheit der Blätter: Paar  
Unité de commande pour les valves: paire



**BV-162**  
Divaricatore solo  
Retractor only  
Sperrer allein  
Ecarteur seul  
Separador suelto

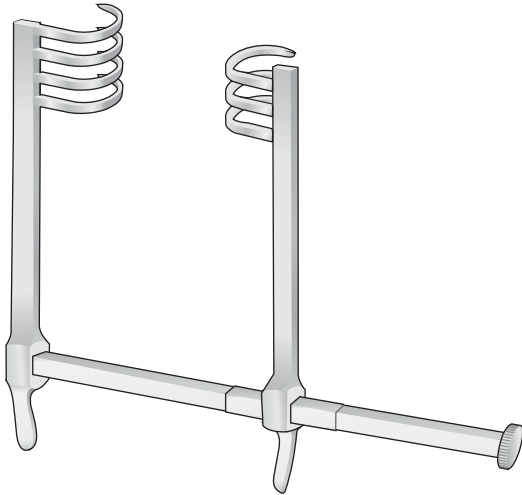
**BV-159**  
Valve laterali  
Lateral blades  
Seitliche Blätter  
Valves latérales  
Valvas laterales  
59 x 80 mm

**BV-144**  
Valva centrale  
Center blade  
Mittelblatt  
Valve centrale  
Valva central  
74 x 82 mm

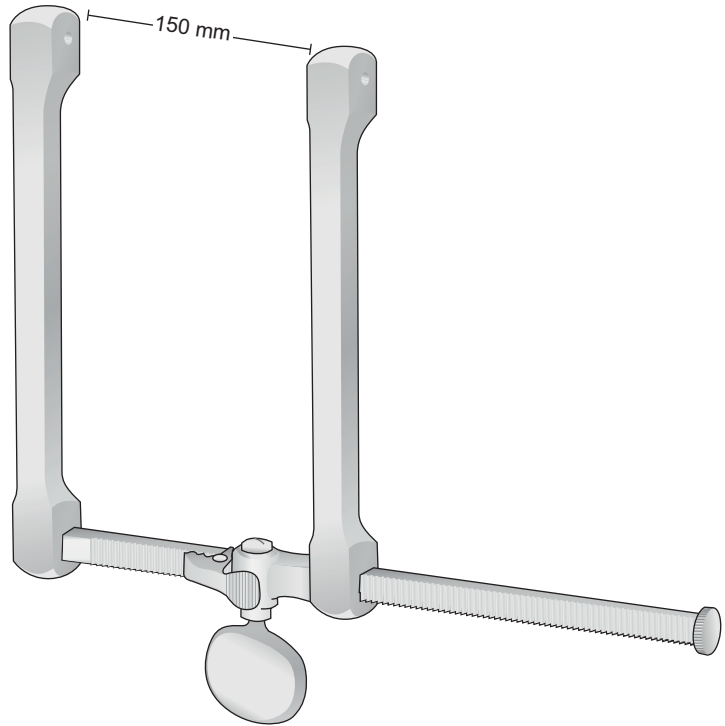
**HOLZBACH  
BV-158**  
Completo - Complete  
Komplett - Complet - Completos



Strumento solo, senza valve  
Frame only - Instrumente allein, ohne Blätter  
Cadre seul - Cuadro solo, no valvas

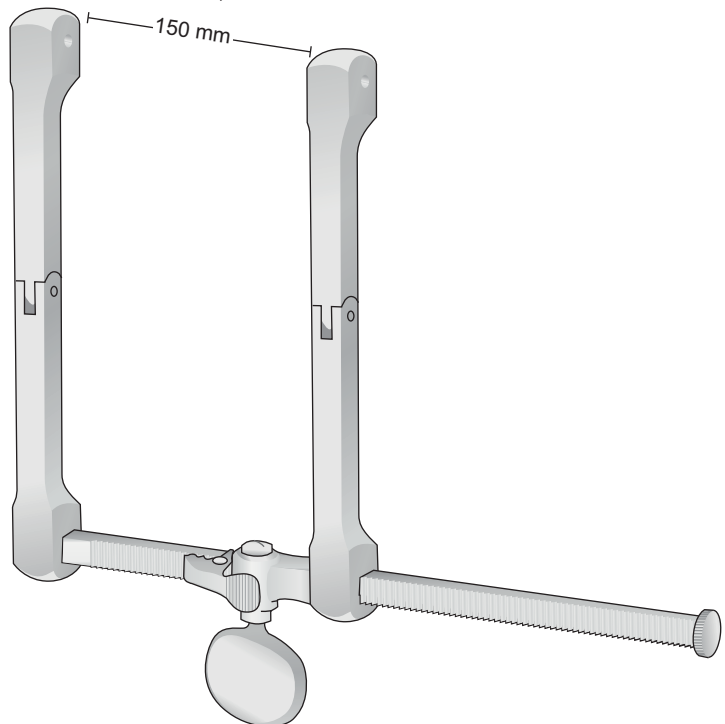


FRAZIER  
BV-35



SCOVILLE  
BV-161

Strumento solo, senza valve  
Frame only, without blade  
Instrumente allein, ohne Blätter  
Cadre seul, sans valves  
Cuadro solo, no valvas

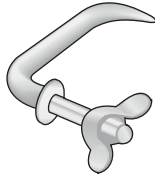


SCOVILLE-HAVERFIELD  
BV-160



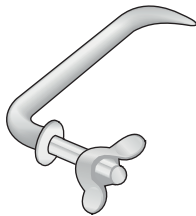


Acuto  
Scharp  
Spitz  
Pointù  
Agudo



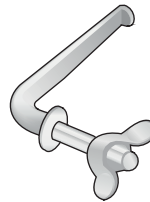
SCOVILLE  
**BV-163**  
50 mm

Acuto  
Scharp  
Spitz  
Pointù  
Agudo



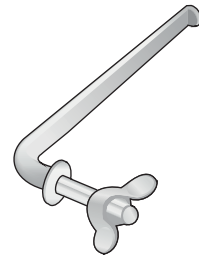
SCOVILLE  
**BV-164**  
70 mm

Smusso  
Blunt  
Stumpf  
Mousse  
Romo

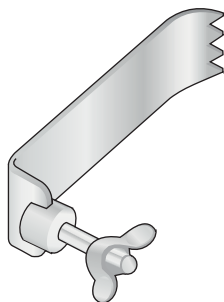


SCOVILLE  
**BV-165**  
50 mm

Smusso  
Blunt  
Stumpf  
Mousse  
Romo

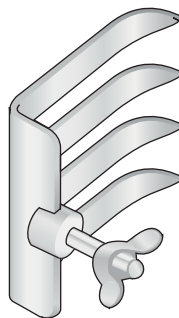


SCOVILLE  
**BV-166**  
70 mm



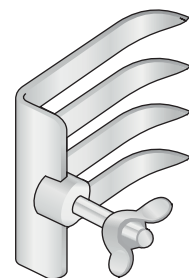
SCOVILLE

<b>BV-167</b>	50x25 mm
<b>BV-168</b>	50x50 mm
<b>BV-169</b>	57x38 mm
<b>BV-170</b>	64x25 mm
<b>BV-171</b>	64x50 mm
<b>BV-172</b>	67x30 mm
<b>BV-173</b>	75x25 mm
<b>BV-174</b>	75x50 mm
<b>BV-175</b>	88x25 mm
<b>BV-176</b>	100x50 mm



TAYLOR

<b>BV-177</b>	48x50 mm
<b>BV-178</b>	64x50 mm
<b>BV-179</b>	64x64 mm
<b>BV-180</b>	80x57 mm



SCOVILLE

<b>BV-181</b>	41x38 mm
<b>BV-182</b>	67x44 mm



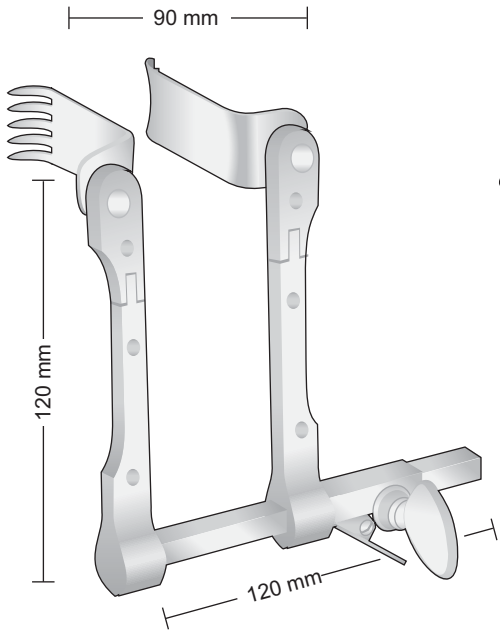
Divaricatori per  
la colonna vertebrale

Retractors for lumbar  
vertebral column

Wundspreizer für die  
Lumbale Wirbelsäule

Ecarteurs pour  
la colonne cervicale

Separadores para  
columna espinal

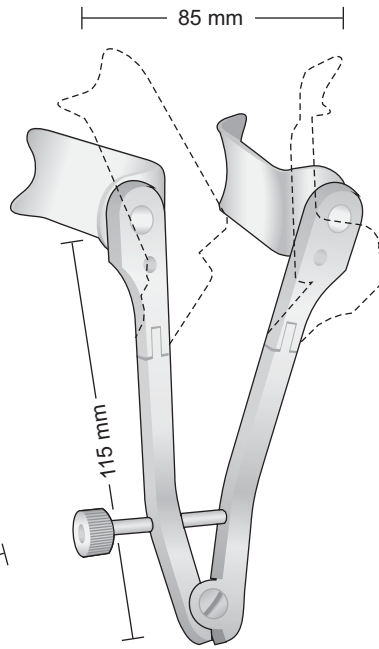


**CASPAR  
BV-250**

Completo con 5 + 5 valve  
Complete with 5 + 5 blade  
Komplett mit 5 + 5 Blätter  
Complet avec 5 + 5 valves  
Completo con 5 + 5 valvas

**BV-249**

Divaricatore solo  
Retractor only  
Sperrer allein  
Ecarteur seul  
Separador suelto

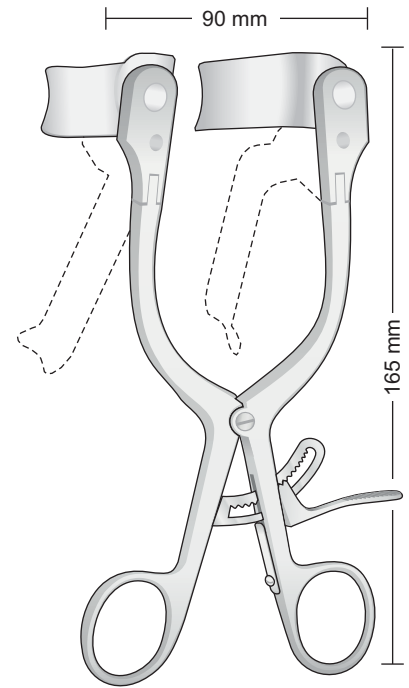


**CASPAR  
BV-270**

Completo con 5 valve  
Complete with 5 blade  
Komplett mit 5 Blätter  
Complet avec 5 valves  
Completo con 5 valvas

**BV-269**

Divaricatore solo  
Retractor only  
Sperrer allein  
Ecarteur seul  
Separador suelto



**CASPAR  
BV-280**

Completo con 5 valve  
Complete with 5 blade  
Komplett mit 5 Blätter  
Complet avec 5 valves  
Completo con 5 valvas

**BV-279**

Divaricatore solo  
Retractor only  
Sperrer allein  
Ecarteur seul  
Separador suelto



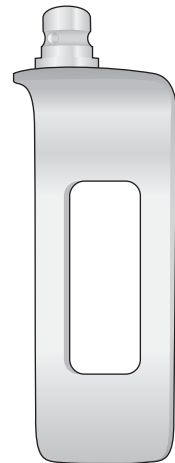
**BV-251**  
40 x 23 mm  
**BV-252**  
45 x 23 mm  
**BV-253**  
50 x 23 mm  
**BV-254**  
55 x 23 mm  
**BV-255**  
60 x 23 mm



**BV-256**  
40 x 23 mm  
**BV-257**  
45 x 23 mm  
**BV-258**  
50 x 23 mm  
**BV-259**  
55 x 23 mm  
**BV-260**  
60 x 23 mm



**BV-271**  
45 x 23 mm  
**BV-272**  
50 x 23 mm  
**BV-273**  
55 x 23 mm  
**BV-274**  
60 x 23 mm  
**BV-275**  
65 x 23 mm



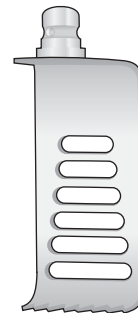
**BV-276**  
50 x 25 mm  
**BV-277**  
60 x 25 mm



Valve in titanio  
Titanium blades  
Titan-valven  
Valves en titane  
Valvas in titanio



- BV-281 T** 25 x 24 mm
- BV-282 T** 30 x 24 mm
- BV-283 T** 35 x 24 mm
- BV-284 T** 40 x 24 mm
- BV-285 T** 45 x 24 mm
- BV-286 T** 25 x 24 mm
- BV-287 T** 30 x 24 mm
- BV-288 T** 35 x 24 mm
- BV-289 T** 40 x 24 mm
- BV-290 T** 45 x 24 mm

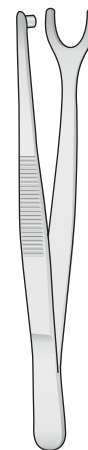


- BV-291 T** 25 x 24 mm
- BV-292 T** 30 x 24 mm
- BV-293 T** 35 x 24 mm
- BV-294 T** 40 x 24 mm
- BV-295 T** 45 x 24 mm
- BV-296 T** 50 x 24 mm
- BV-297 T** 55 x 24 mm
- BV-298 T** 60 x 24 mm
- BV-299 T** 65 x 24 mm
- BV-300 T** 70 x 24 mm



- BV-301 T** 30 x 24 mm
- BV-302 T** 35 x 24 mm
- BV-303 T** 40 x 24 mm
- BV-304 T** 45 x 24 mm
- BV-305 T** 50 x 24 mm
- BV-306 T** 55 x 24 mm
- BV-307 T** 60 x 24 mm
- BV-308 T** 65 x 24 mm
- BV-309 T** 70 x 24 mm
- BV-310 T** 75 x 24 mm

Pinzetta per la sostituzione delle valve  
con i bloccaggi rapidi a sfera  
Blade ejector for changing the blades  
with ball snap closure  
Pinzette zum wechseln der valven  
mit kugelschnellverschluss  
Pincas pour changer les valves munies  
du système de verrouillage rapide à billes



**BV-229**  
115 mm



Divaricatori per  
microchirurgia lombare

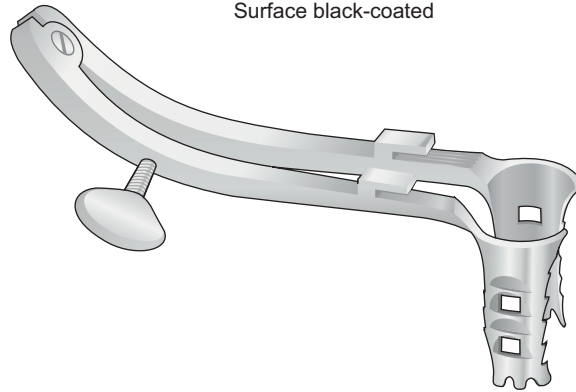
Retractors for  
Micro-Lumbar Discectomy

Wundspreizer zur  
Mikrodissektomie

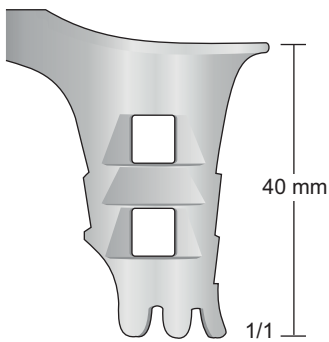
Ecarteurs pour  
Micro chirurgie

Separadors para  
micro chirurgia

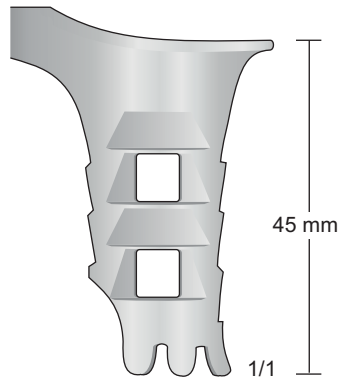
Oberfläche schwarz beschichtet  
Surface black-coated



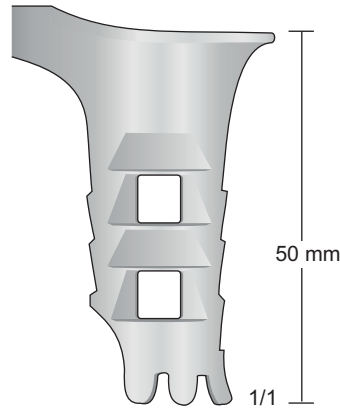
CASPAR  
BV-201/BV-208



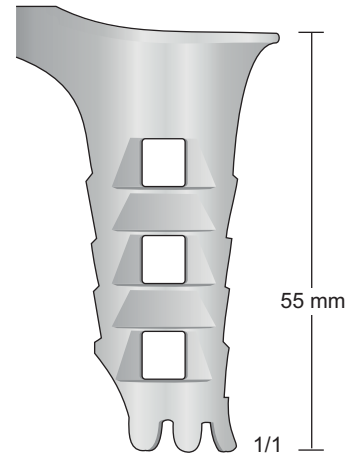
BV-201



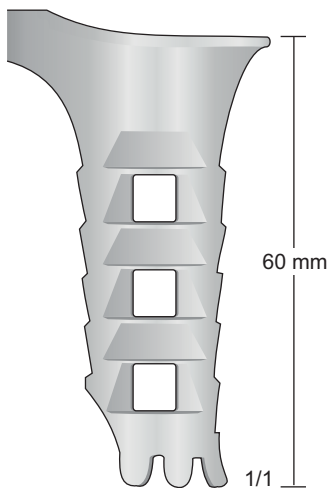
BV-202



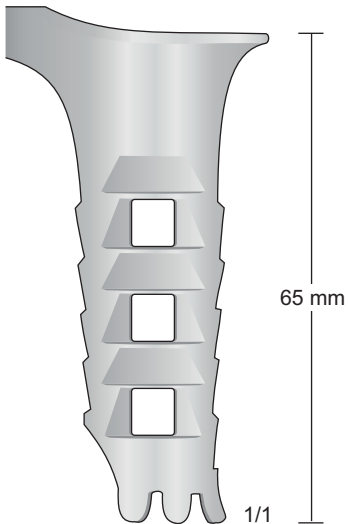
BV-203



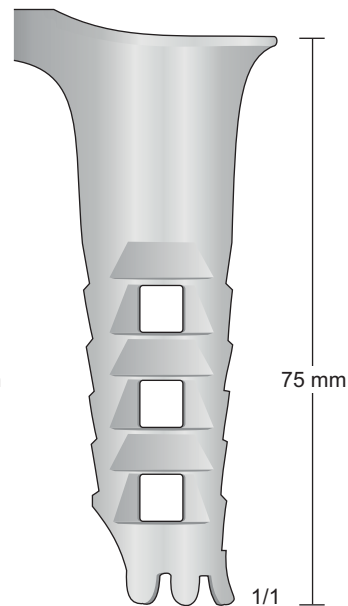
BV-204



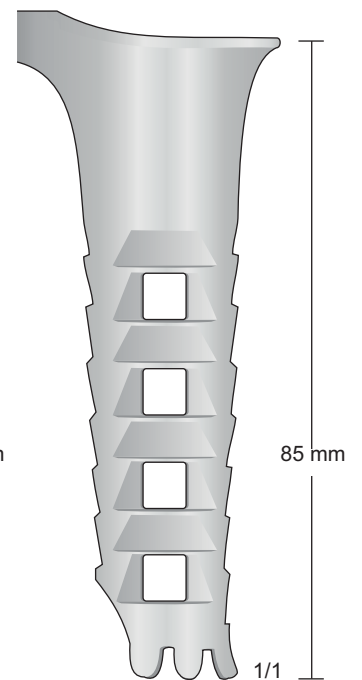
BV-205



BV-206



BV-207



BV-208



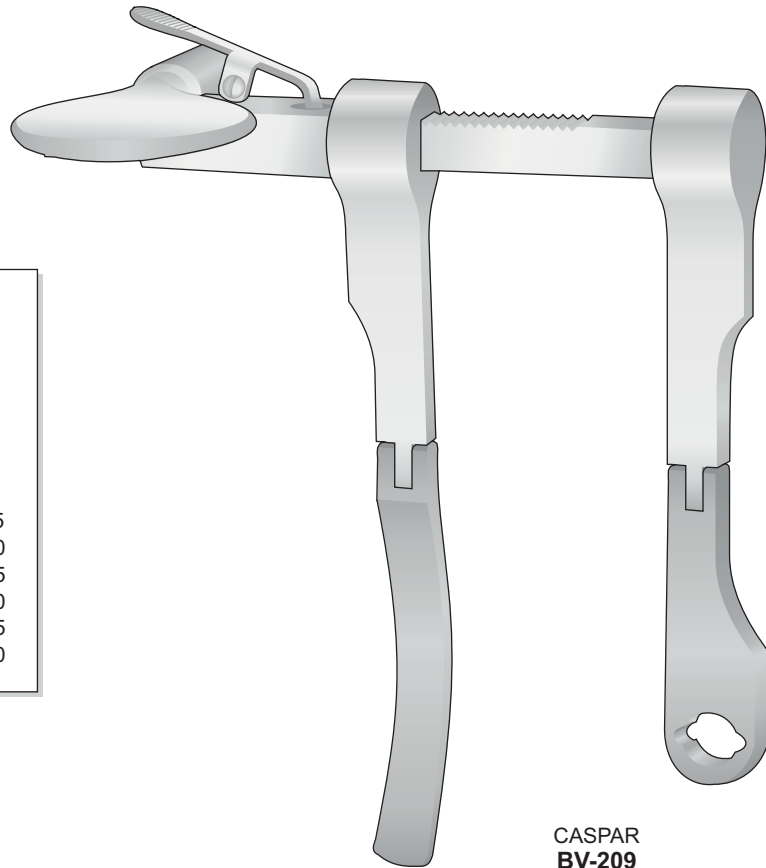
Divaricatori per  
microchirurgia lombare

Retractors for  
Micro-Lumbar Discectomy

Wundspreizer zur  
Mikrodiskektomie

Ecarteurs pour  
Micro chirurgie

Separadors para  
micro chirurgia



**CASPAR  
BV-210**

Divaricatore completo di  
Retractor complete with  
Sperrer komplett mit  
Ecarteur complet avec  
Separador completo con

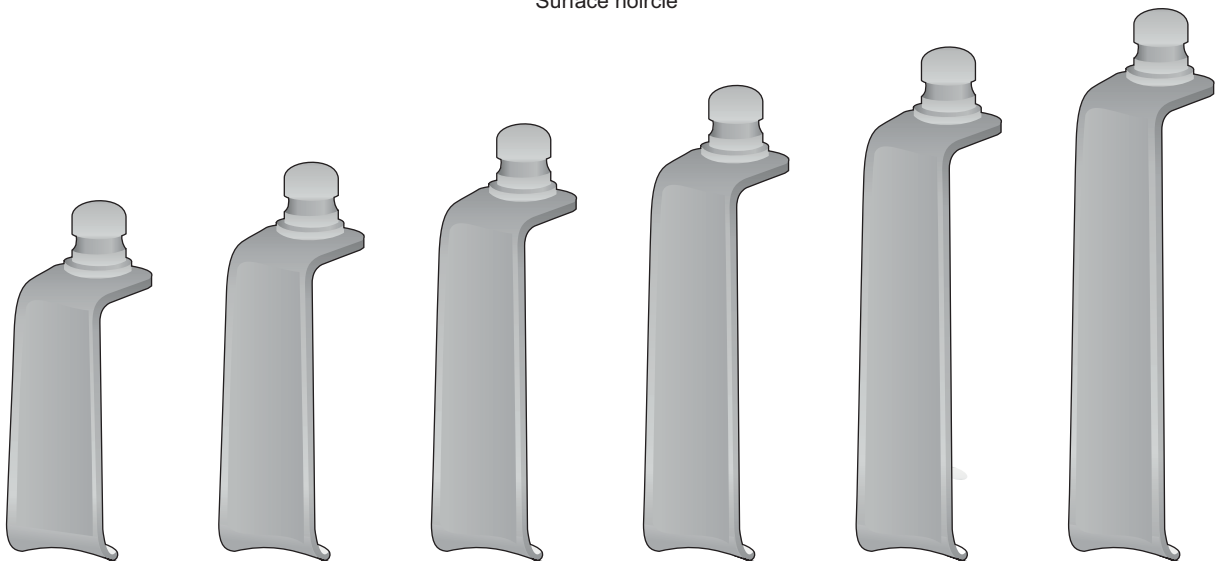
- BV-211** Valva anti-riflesso mm. 35
- BV-212** Valva anti-riflesso mm. 40
- BV-213** Valva anti-riflesso mm. 45
- BV-214** Valva anti-riflesso mm. 50
- BV-215** Valva anti-riflesso mm. 55
- BV-216** Valva anti-riflesso mm. 60

**BV-209**

Divaricatore solo  
Retractor only  
Sperrer allein  
Ecarteur seul  
Separador suelto

**CASPAR  
BV-209**

Valve anti-riflesso  
Surface Black-coated  
Oberfläche schwarz Beschichtet  
Surface noircie



**BV-211**  
35 mm

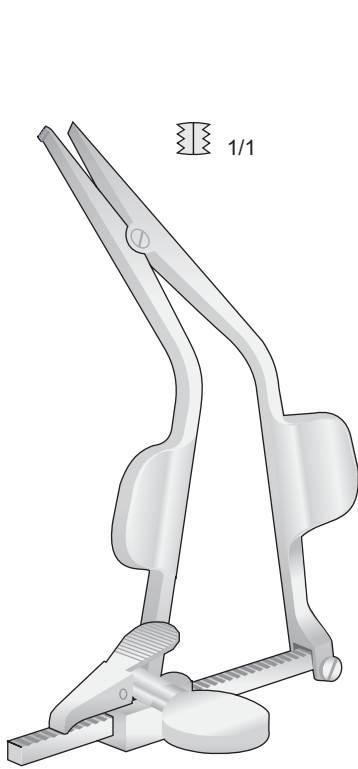
**BV-212**  
40 mm

**BV-213**  
45 mm

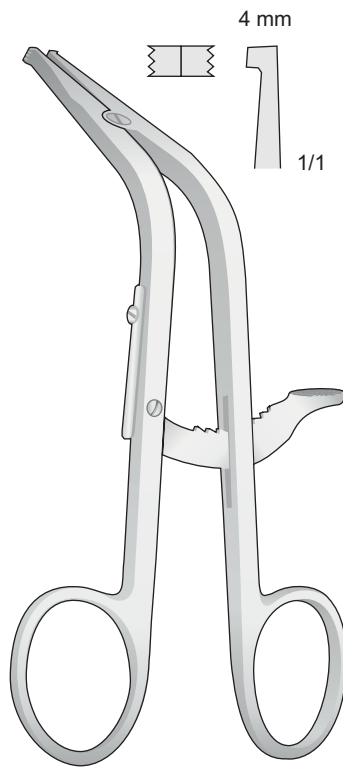
**BV-214**  
50 mm

**BV-215**  
55 mm

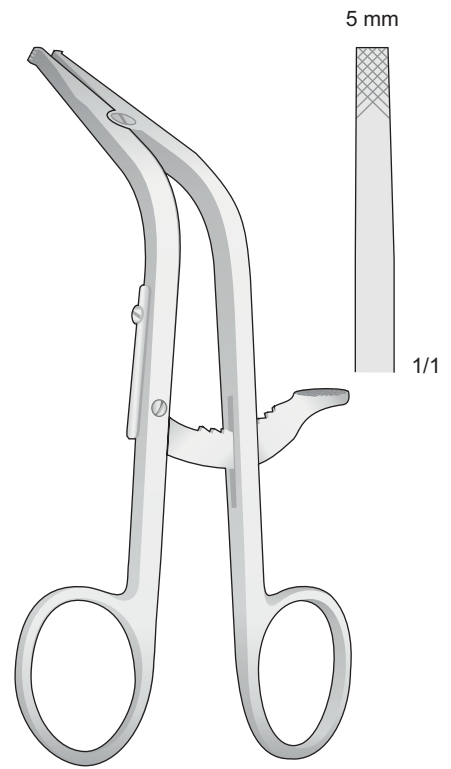
**BV-216**  
60 mm



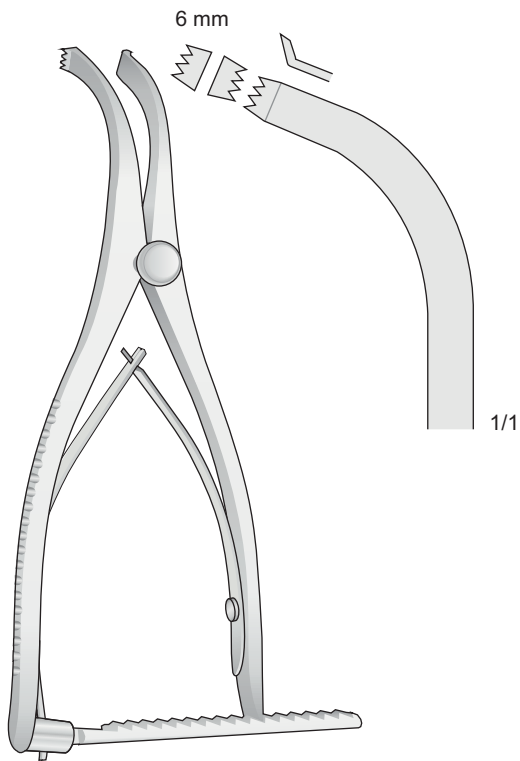
CLOWARD  
**BV-86**  
150 mm



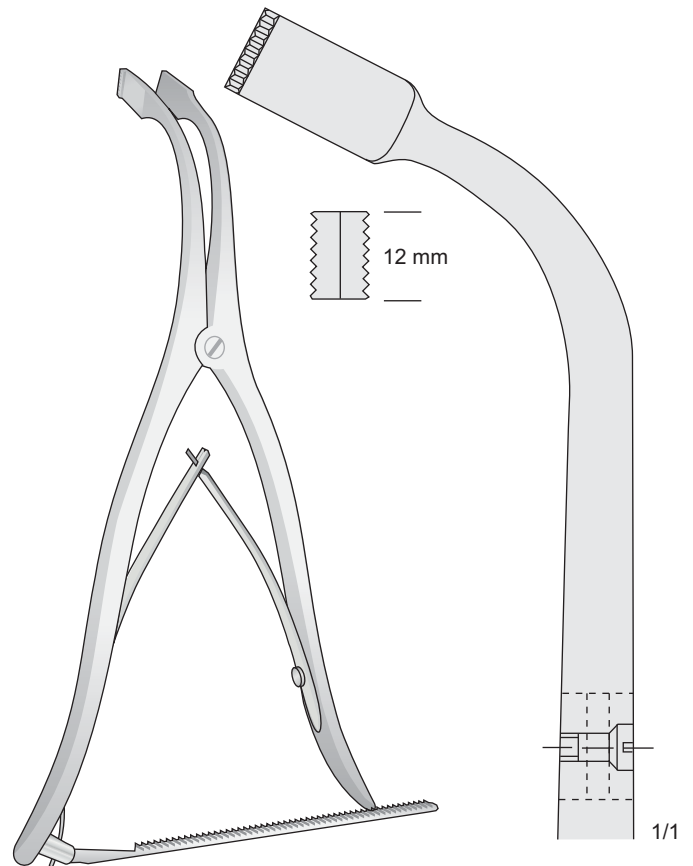
CLOWARD  
**BV-84**  
160 mm



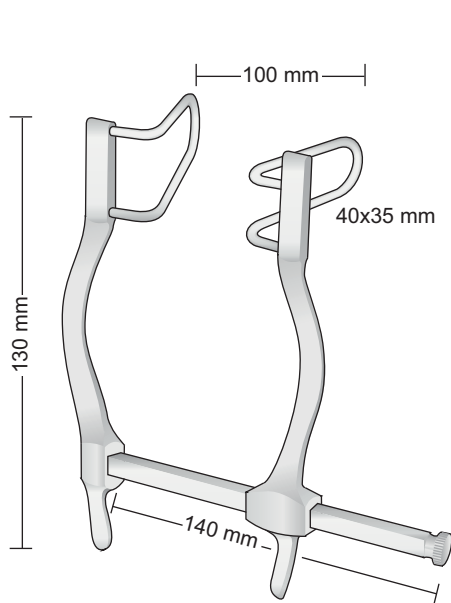
CLOWARD  
**BV-85**  
160 mm



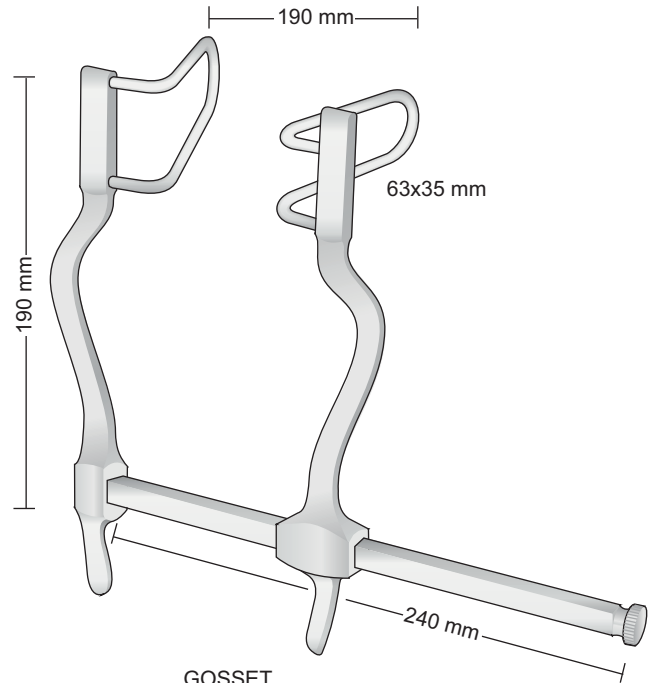
INGE  
**BV-80**  
160 mm



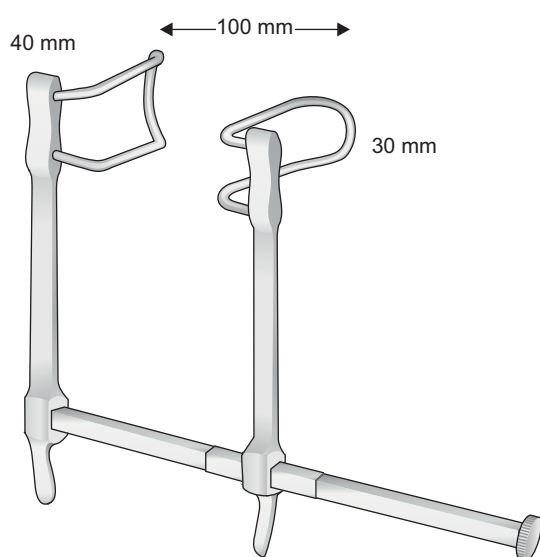
INGE  
**BV-82**  
275 mm



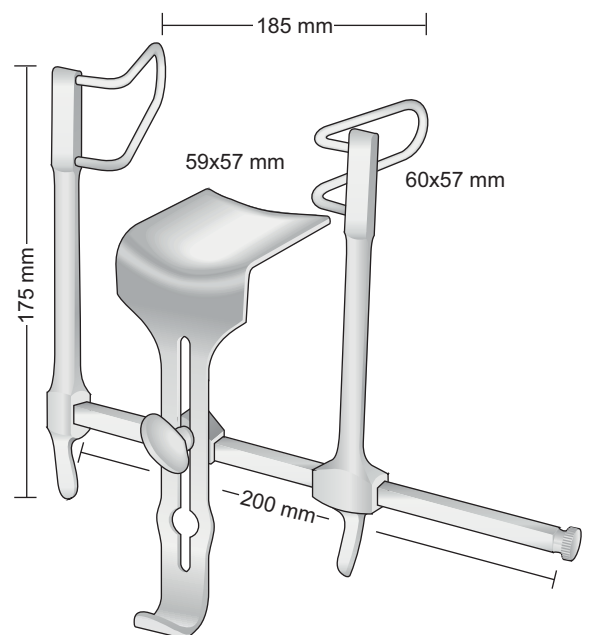
GOSSET  
BV-31



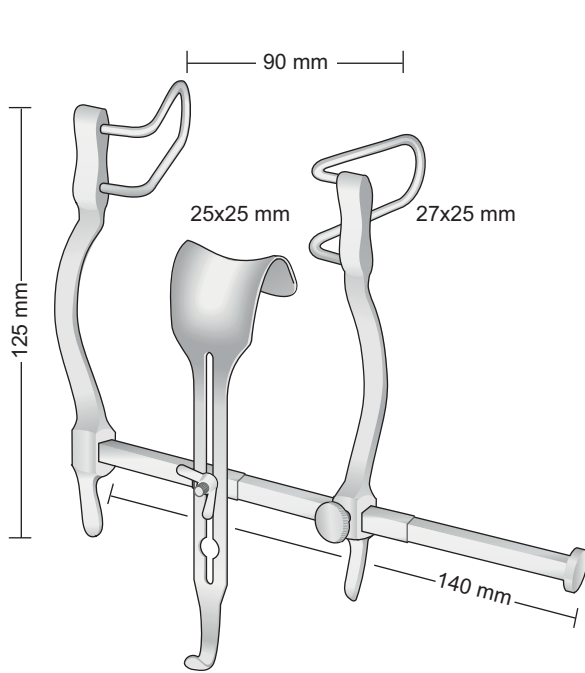
GOSSET  
BV-30



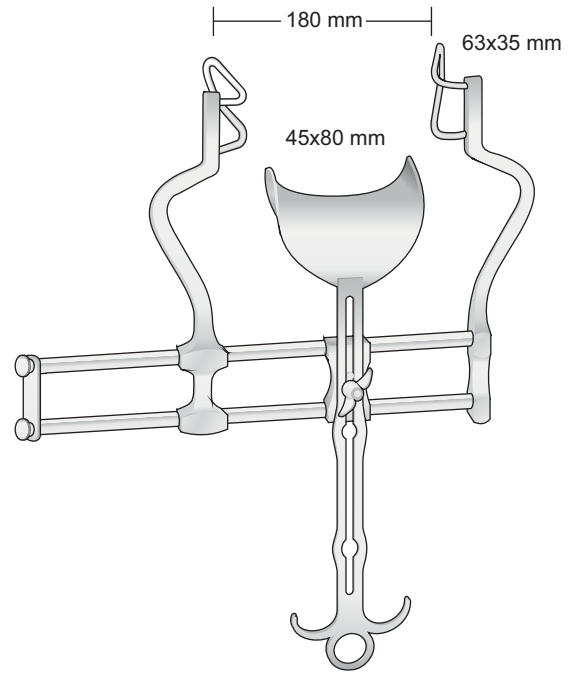
GOSSET  
BV-33



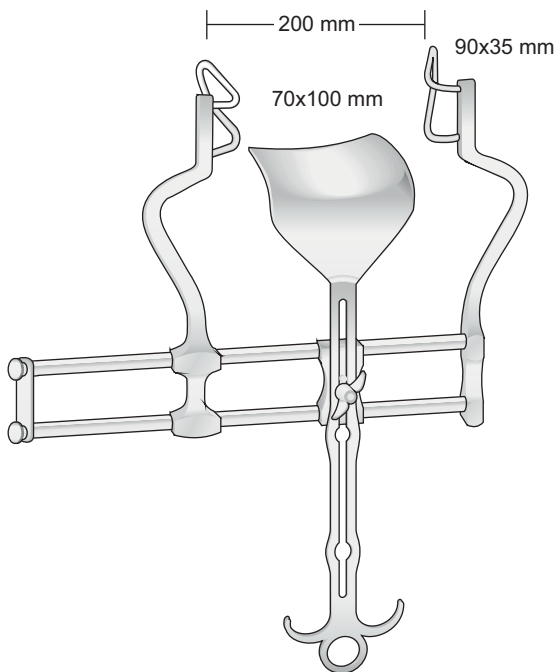
GOSSET  
BV-32



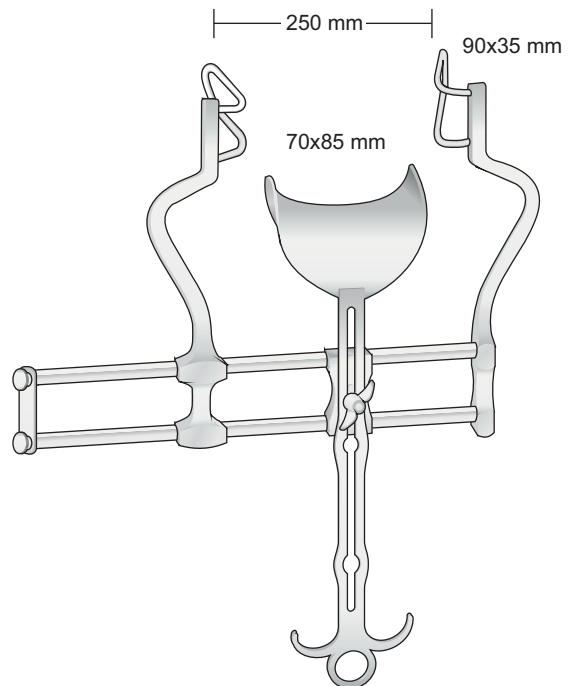
BALFOUR-BABY  
BV-41



BALFOUR  
BV-40



BALFOUR  
BV-42

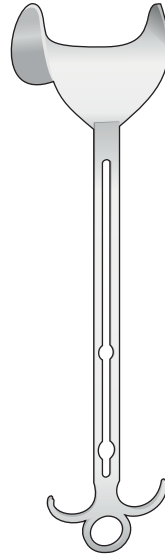


BALFOUR  
BV-43



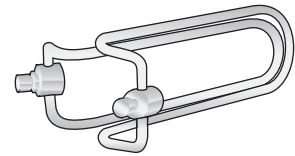


Valva centrale - Center blade  
Mittelblatt - Valve centrale - Valva central



BALFOUR  
**BV-153**  
45 x 80 mm

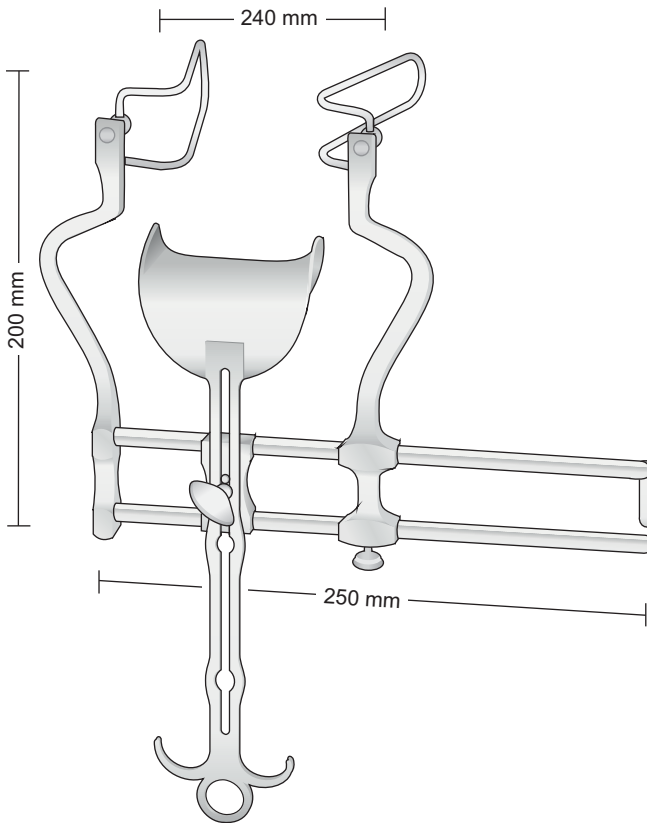
Valve laterali - paio  
Lateral blades - pair  
Seitliche Blätter - Paar  
Valves latérales - paires  
Valvas laterales - pares



**BV-186** - 50 mm  
**BV-187** - 60 mm  
**BV-188** - 75 mm  
**BV-189** - 90 mm

**BV-184**  
Completo con:  
Complete with:  
Komplett mit:  
Complet avec:  
Completo con:

**BV-185 - BV-153 - BV-186**



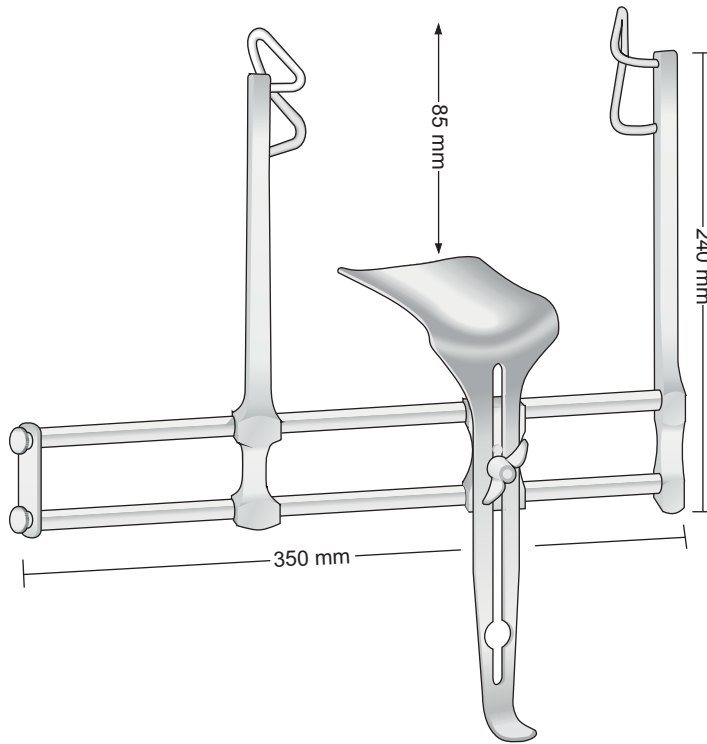
BALFOUR  
**BV-184**

**BV-185**  
BALFOUR  
Divaricatore solo  
Retractor only  
Sperrer allein  
Ecarteur seul  
Separador suelto

**BV-153**  
Valva centrale  
Center blade  
Mittelblatt  
Valve centrale  
Valva central  
45 x 80 mm

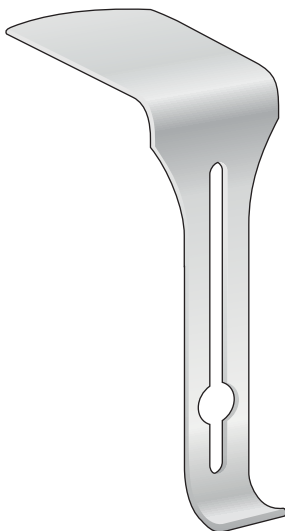
**BV-156**  
Valva centrale  
Center blade  
Mittelblatt  
Valve centrale  
Valva central  
60 x 80 mm

**BV-157**  
Valva centrale  
Center blade  
Mittelblatt  
Valve centrale  
Valva central  
80 x 80 mm



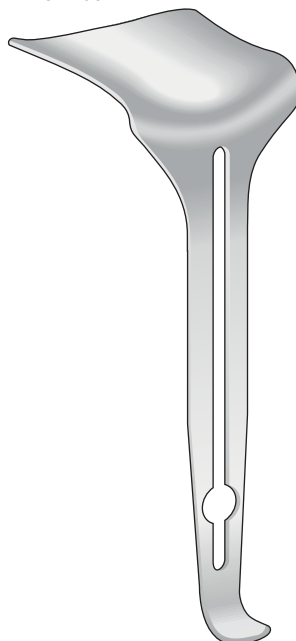
BALFOUR MODIF.  
**BV-46**

45 X 85 mm



**BV-150**  
170 mm

75 X 65 mm

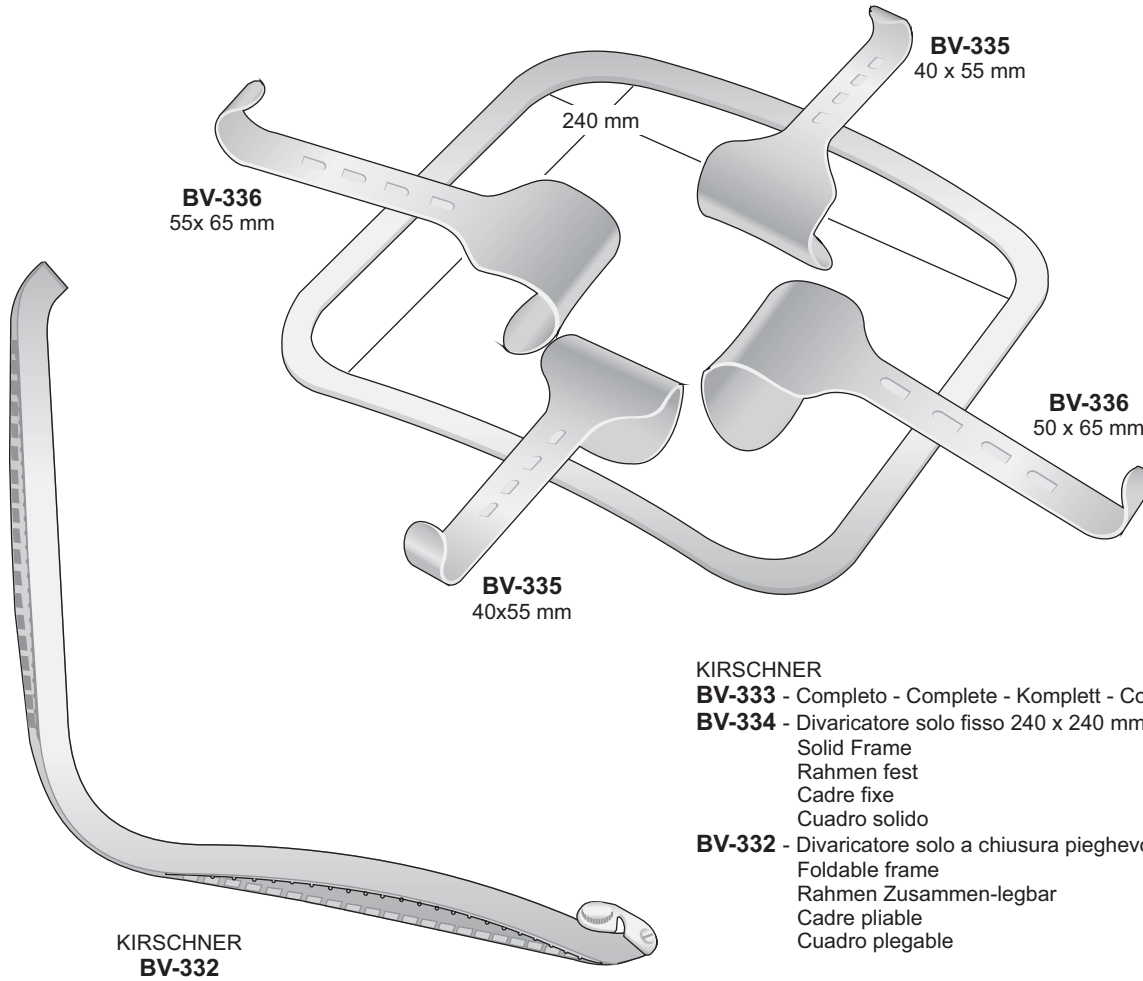


**BV-151**  
230 mm

70 X 100 mm



**BV-152**  
200 mm



KIRSCHNER

**BV-333** - Completo - Complete - Komplett - Complet - Completo

**BV-334** - Divaricatore solo fisso 240 x 240 mm

Solid Frame

Rahmen fest

Cadre fixe

Cuadro solido

**BV-332** - Divaricatore solo a chiusura pieghevole 240 x 240 mm

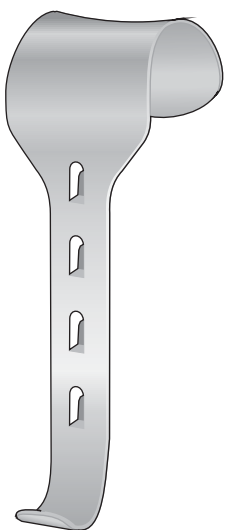
Foldable frame

Rahmen Zusammen-legbar

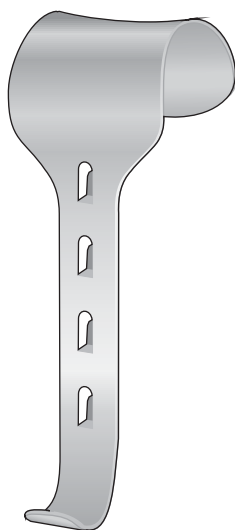
Cadre pliable

Cuadro plegable

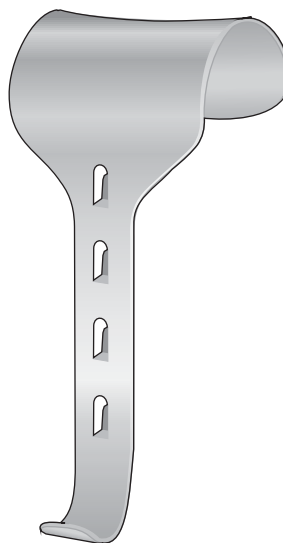
KIRSCHNER  
**BV-332**



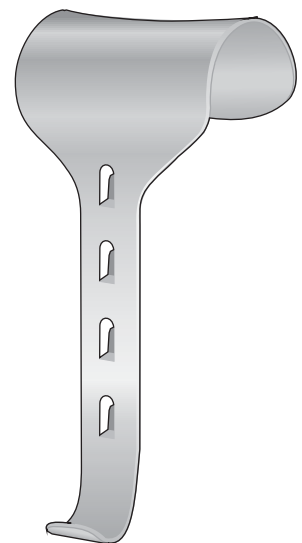
KIRSCHNER  
**BV-335**  
40 x 55 mm



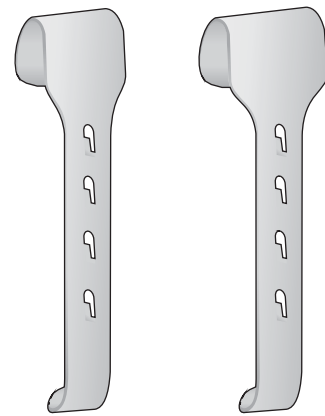
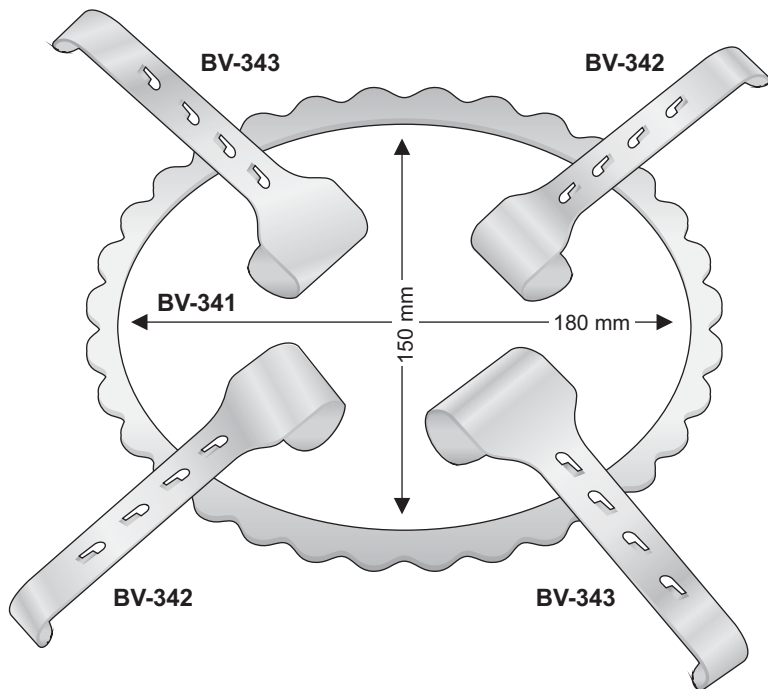
KIRSCHNER  
**BV-331** - 65 x 80 mm  
**BV-336** - 50 x 65 mm



KIRSCHNER  
**BV-337** - 60 x 85 mm  
**BV-338** - 78 x 65 mm  
**BV-339** - 90 x 65 mm



KIRSCHNER  
**BV-346** - 80 x 80 mm  
**BV-347** - 80 x 90 mm  
**BV-348** - 90 x 90 mm



**BV-344**  
20 x 30 mm

**BV-345**  
20 x 40 mm

DENIS-BROWNE  
**BV-340**

Set completo per bambini  
Set complete for children  
Komplettsset für Kinder  
Set complete pour enfants  
Set completo para niños

**BV-341** - 1 Cornice 180 x 150 mm  
**BV-344** - 2 Valve 20 x 30 mm  
**BV-345** - 2 Valve 20 x 40 mm

DENIS-BROWNE  
**BV-350**

Set completo per adulti  
Set complete for adults  
Komplettsset für Erwachsene  
Set complete pour adultes  
Set completo para adultos

**BV-349** - 1 Cornice 255 x 180 mm  
**BV-342** - 2 Valve 40 x 30 mm  
**BV-343** - 2 Valve 40 x 40 mm

**BV-341**

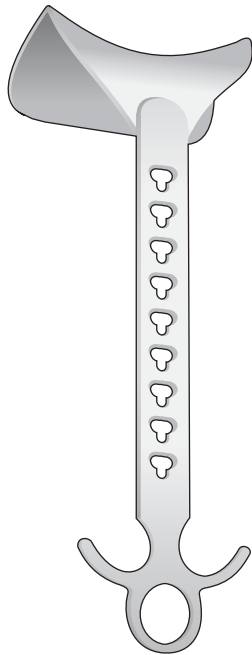
180 x 150 mm  
Cornice sola  
Frame only  
Rahmen allein  
Ecarteur seul  
Separador suelto

Per bambini - For children  
Für Kinder - Pour enfants  
Para niños

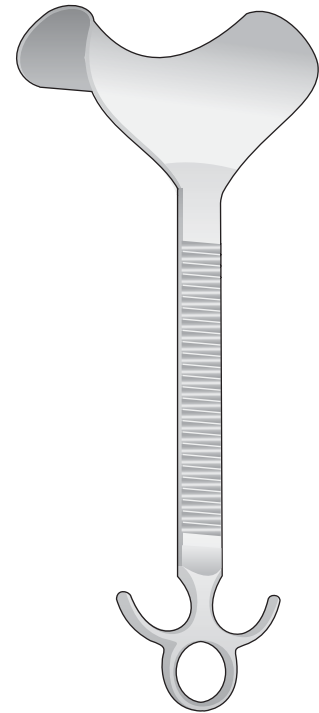
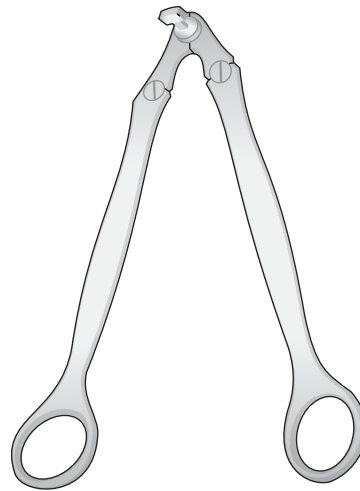
**BV-349**

255 x 180 mm  
Cornice sola  
Frame only  
Rahmen allein  
Ecarteur seul  
Separador suelto

Per adulti - For adults  
Für Erwachsene - Pour adultes  
Para adultos



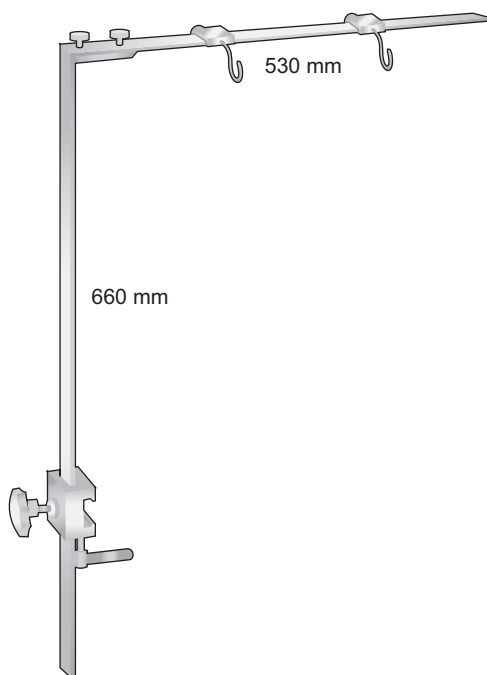
Dispositivo di fissaggio  
 Fixation device  
 Fixiervorrichtung  
 Dispositif de fixation articulé  
 Dispositivo de fijación



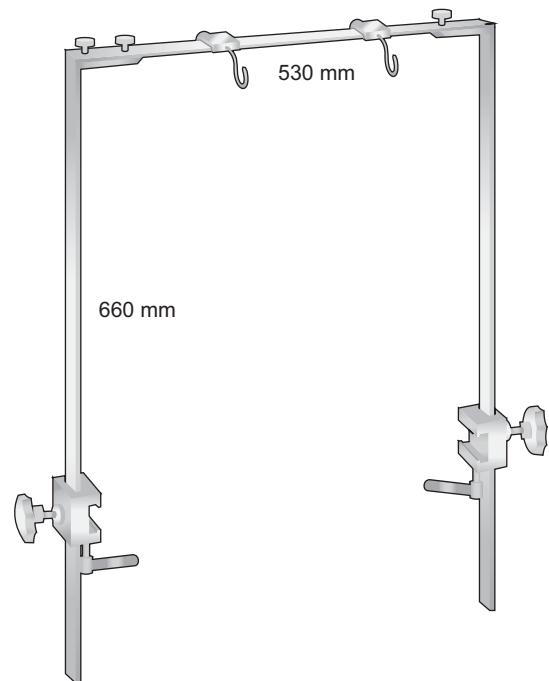
ROCHARD  
**BV-383** - 60 x 95 mm  
**BV-384** - 60 x 105 mm  
**BV-385** - 60 x 120 mm  
**BV-386** - 60 x 135 mm  
**BV-387** - 60 x 155 mm  
 270 mm

ROCHARD  
**BV-388**  
 190 mm

DOYEN  
**BT-255** - 50 x 85 mm  
**BT-256** - 48 x 90 mm  
**BT-257** - 48 x 105 mm  
**BT-258** - 48 x 120 mm  
**BT-259** - 48 x 135 mm  
 280 mm



ROCHARD  
**BV-389**



ROCHARD  
**BV-390**

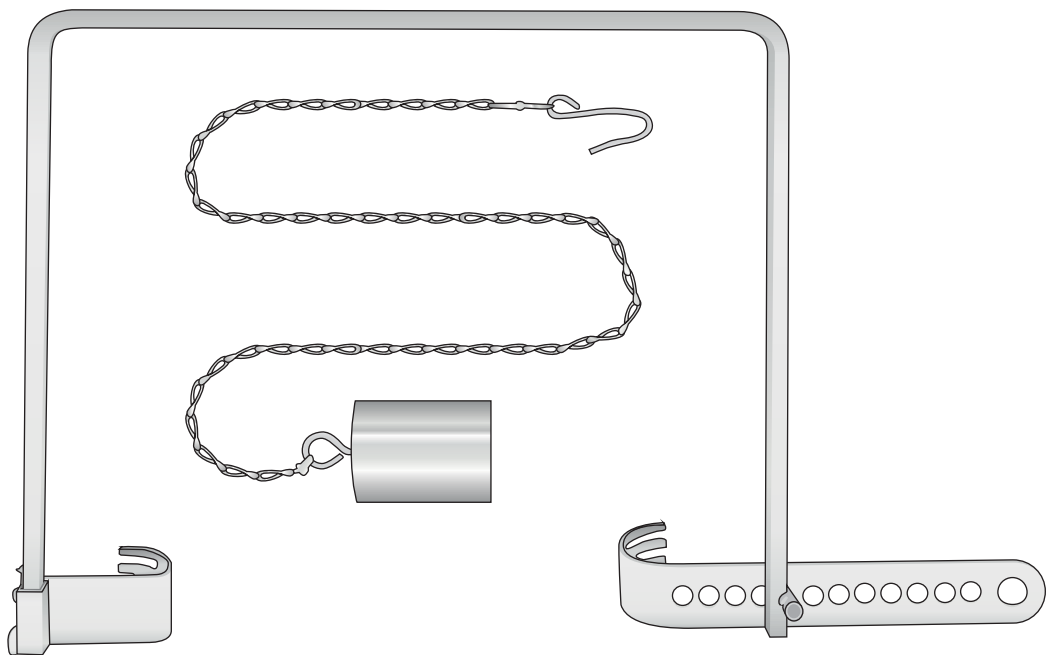


**BV-263**  
Valva regolabile  
Large blade

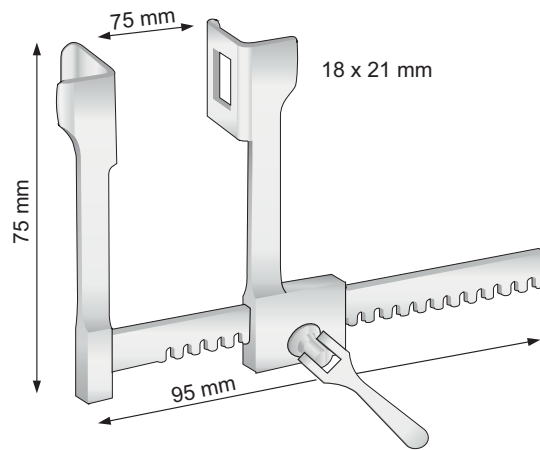
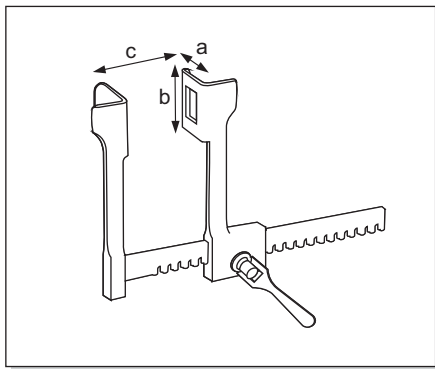
**BV-264**  
Valva piccola  
Small blade

**BV-265**  
Contrappeso + catenella  
Weight with chain

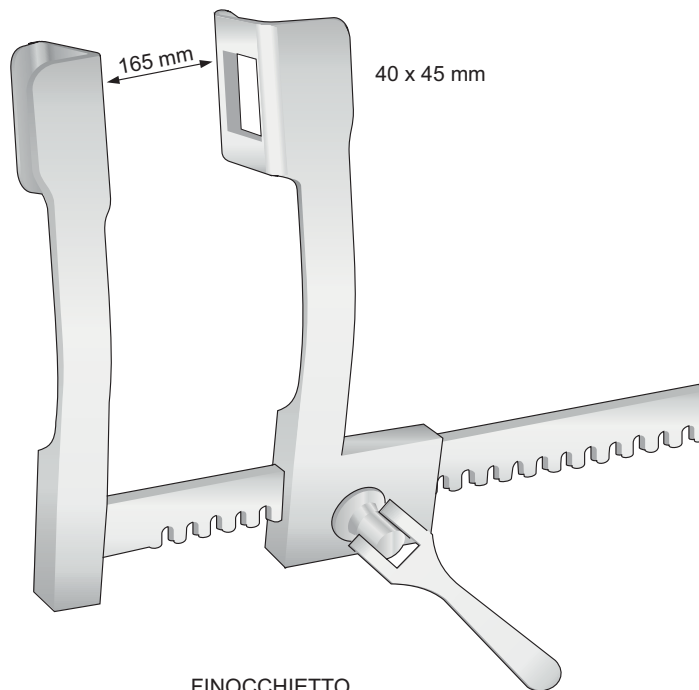
Divaricatore per anca  
Retractor with chain  
Wundhaken mit Kette



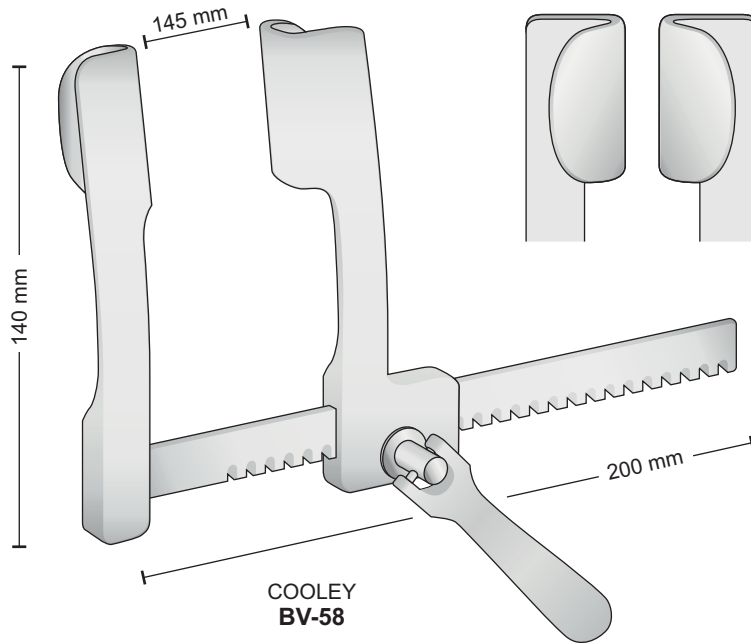
CHARNELY  
**BV-262**  
Completo - Complete - Komplett  
Complete - Completos



BABY FINOCCHIETTO  
a b c  
**BV-60** 18 x 21 mm 75 mm

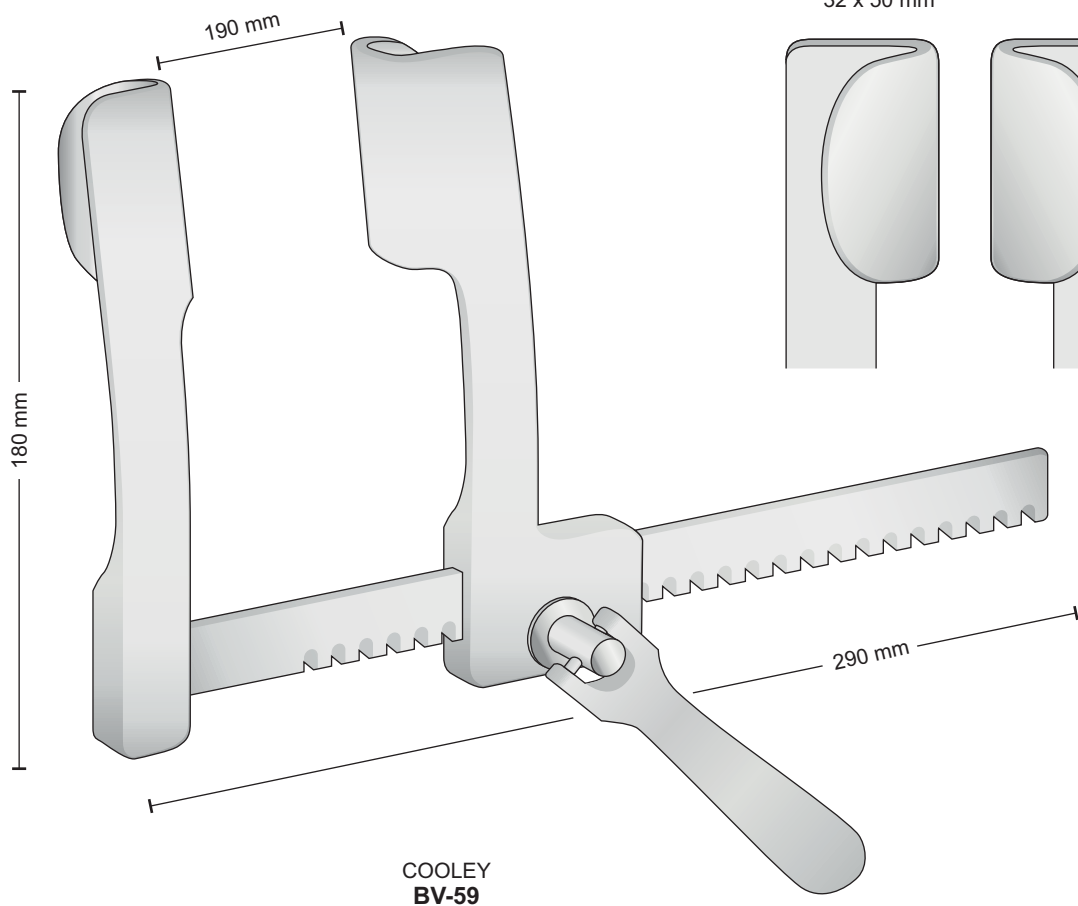


FINOCCHIETTO  
a b c  
**BV-62** 40 x 45 mm 165 mm  
**BV-64** 45 x 65 mm 200 mm  
**BV-66** 70 x 65 mm 250 mm



Valve  
Blades  
Blätter  
Valves  
Valvas  
21 x 45 mm

Per bambini  
For children  
Für Kinder  
Pour enfants  
Para niños



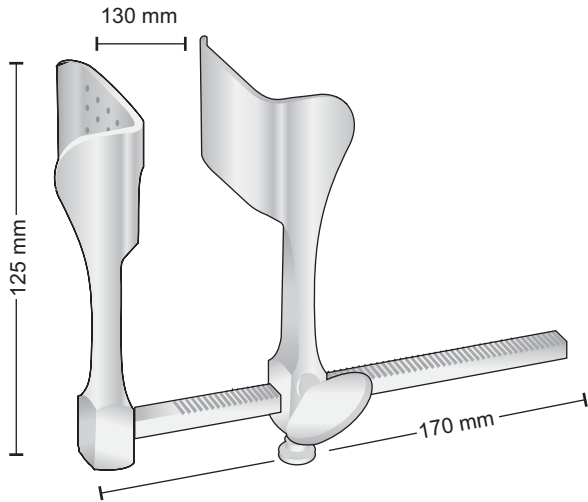
Valve  
Blades  
Blätter  
Valves  
Valvas  
32 x 50 mm

Per adulti  
For adults  
Für Erwachsene  
Pour adultes  
Para adultos



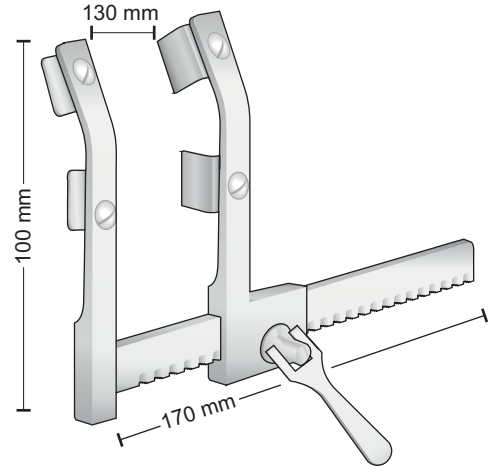


Valve - Blade - Blätter  
Valve - Valvas  
50 x 43 mm



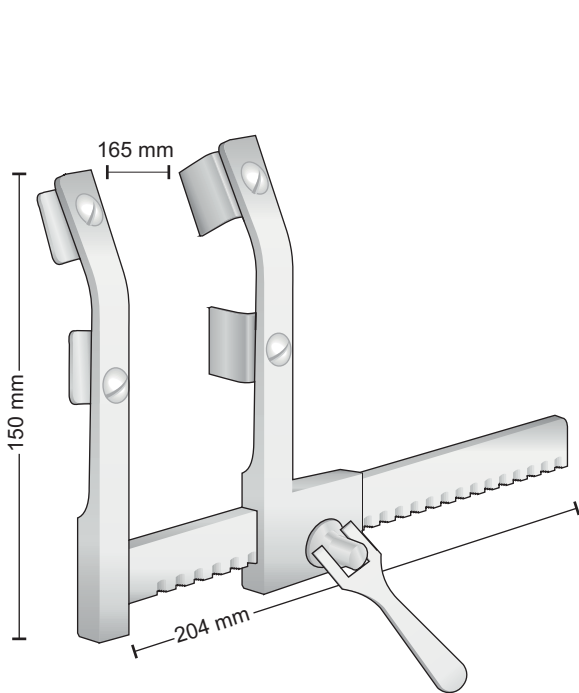
TUFFIER  
BV-57

Divaricatori per sternotomia  
Sternotomy spreaders  
Sternotomie-Sperrer  
Ecarteurs à sternotomie  
Separador para sternotomia

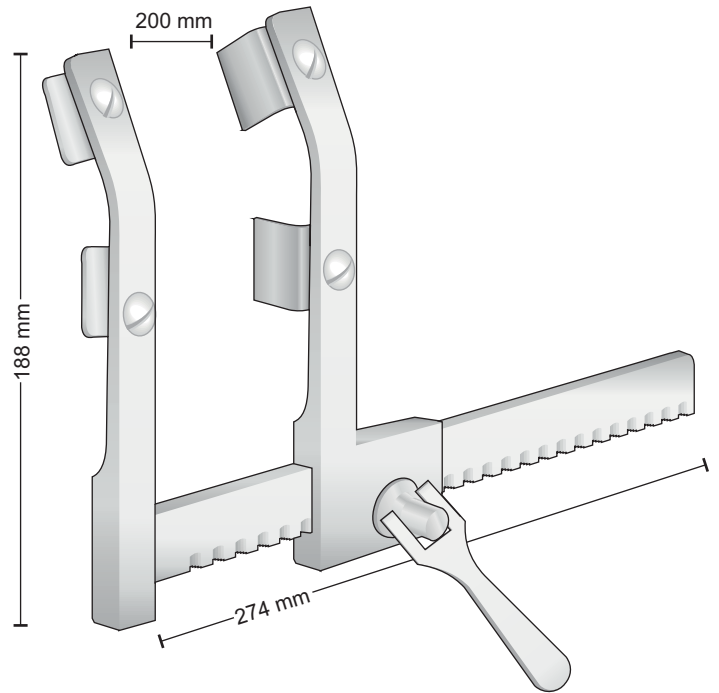


BABY-MORSE  
BV-125

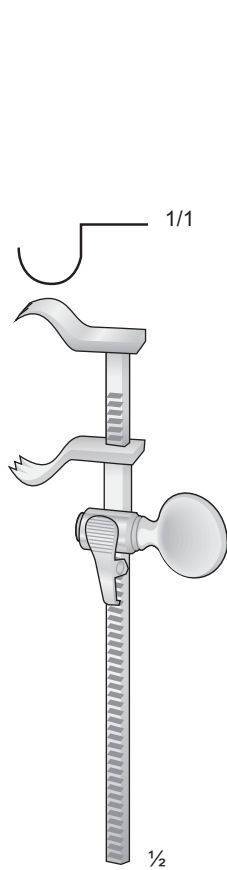
Divaricatori per sternotomia - Sternotomy spreaders - Sternotomie-Sperrer  
Ecarteurs à sternotomie - Separador para sternotomia



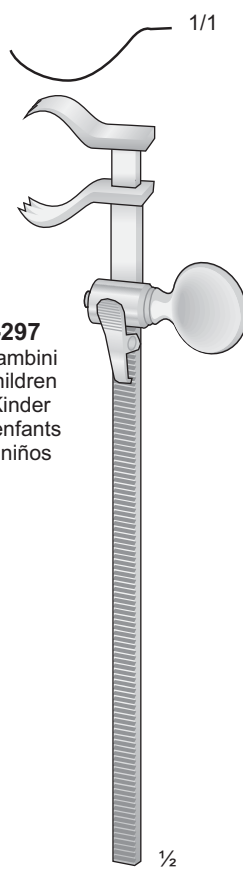
MORSE  
BV-126



MORSE  
BV-128

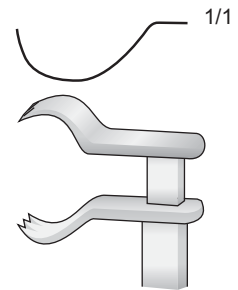


BAILEY  
FB-296  
160 mm



**FB-297**  
Per bambini  
For children  
Für Kinder  
Pour enfants  
Para niños

BAILEY  
FB-297-FB-298  
200 mm

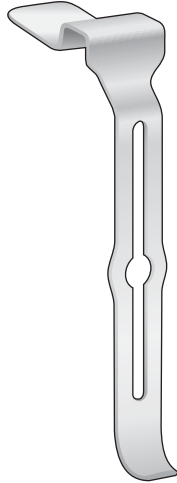


**FB-298**  
Per adulti  
For adults  
Für Erwachsene  
Pour adultes  
Para adultos

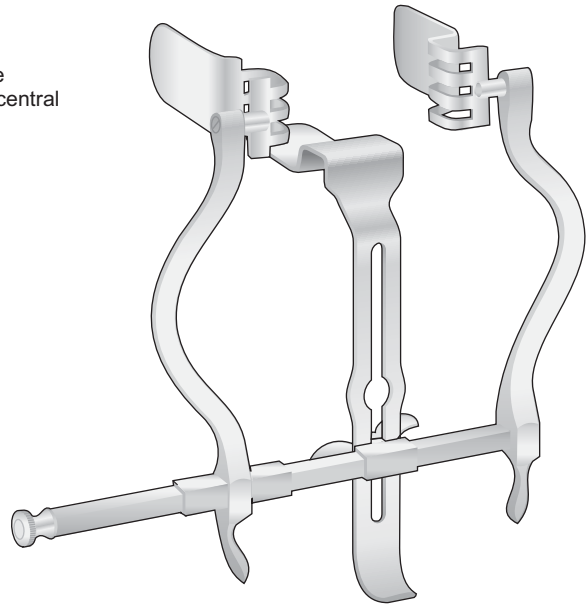


Divaricatori vescicali - Bladder retractors - Blasenwundspreizer  
Ecarteurs vésicaux - Separadores vesicales

Valva centrale - Center blade  
Mittelblatt - Valve centrale - Valva central

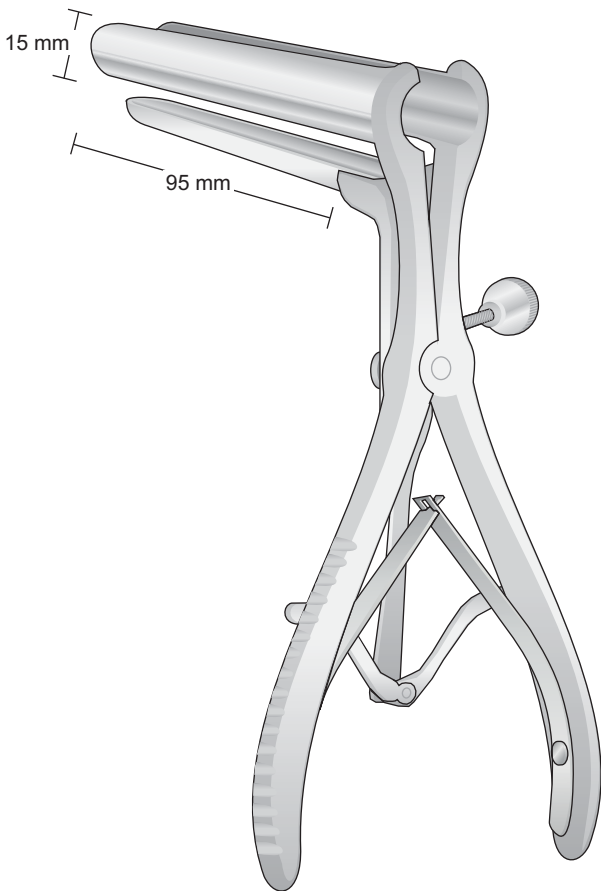


**BV-355**



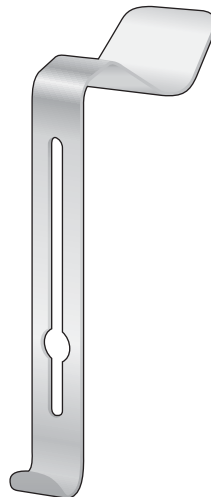
**JUDD-MASSON  
BV-354**

Speculum rettale  
Rectal Specula  
Mastdarm Rektum Spekula  
Spéculum rectaux  
Espéculos rectales



**MATHIEU  
EA-40  
215 mm**

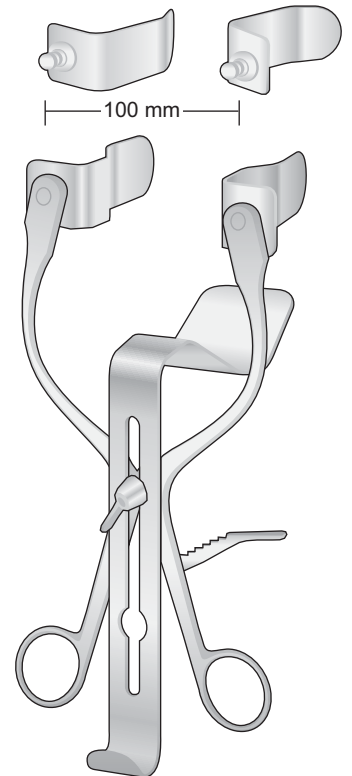
**BV-360**  
Valva laterale  
Lateral blade  
Seitliche Blätter  
Valves latérales  
Valva laterales  
80 x 25 mm



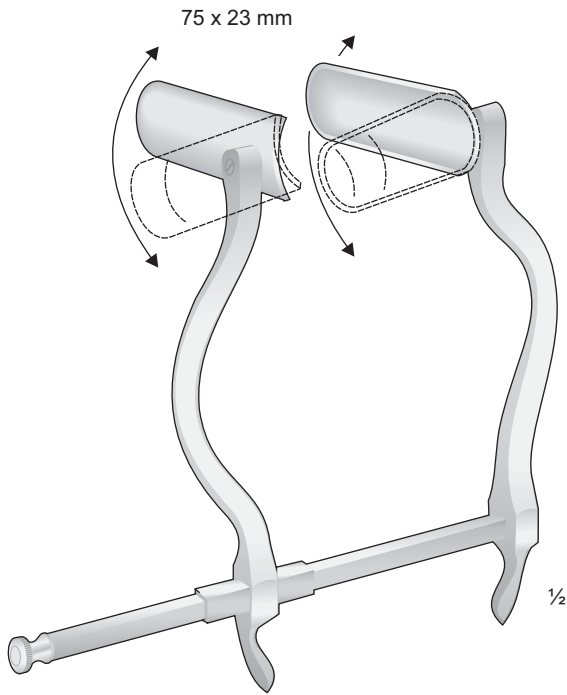
**BV-359**

Valva centrale - Center blade - Mittelblatt  
Valve centrale - Valva central

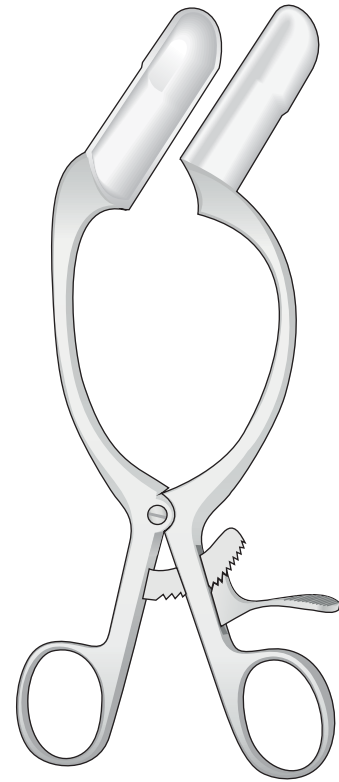
**BV-358**  
Divaricatore solo - Retractor only  
Sperrer allein - Ecarteur seul  
Separador suelto



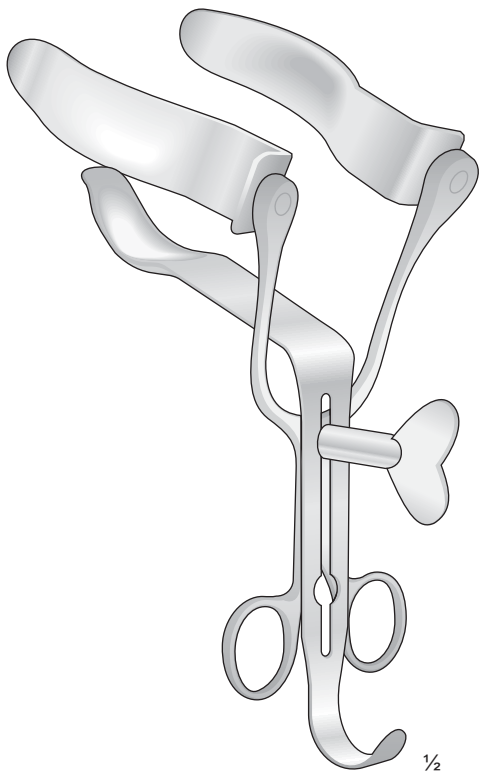
**MILLIN  
BV-357  
Completo - Complete - Komplet  
Complet - Completo**



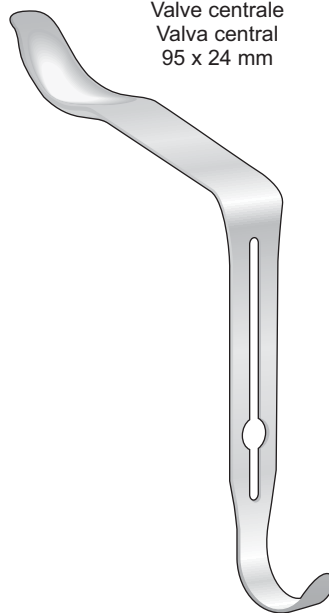
SMITH-BUIE  
BV-241  
150 mm



BARR  
BV-242  
170 mm

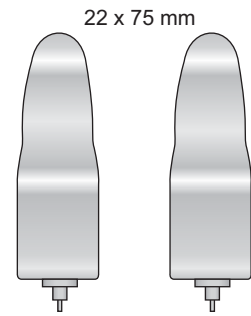


ALAN PARKS  
BV-245  
135 mm

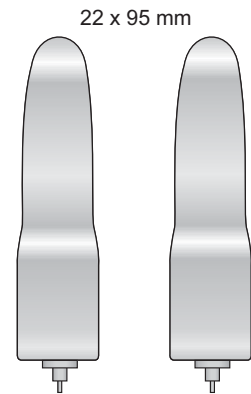


BV-248

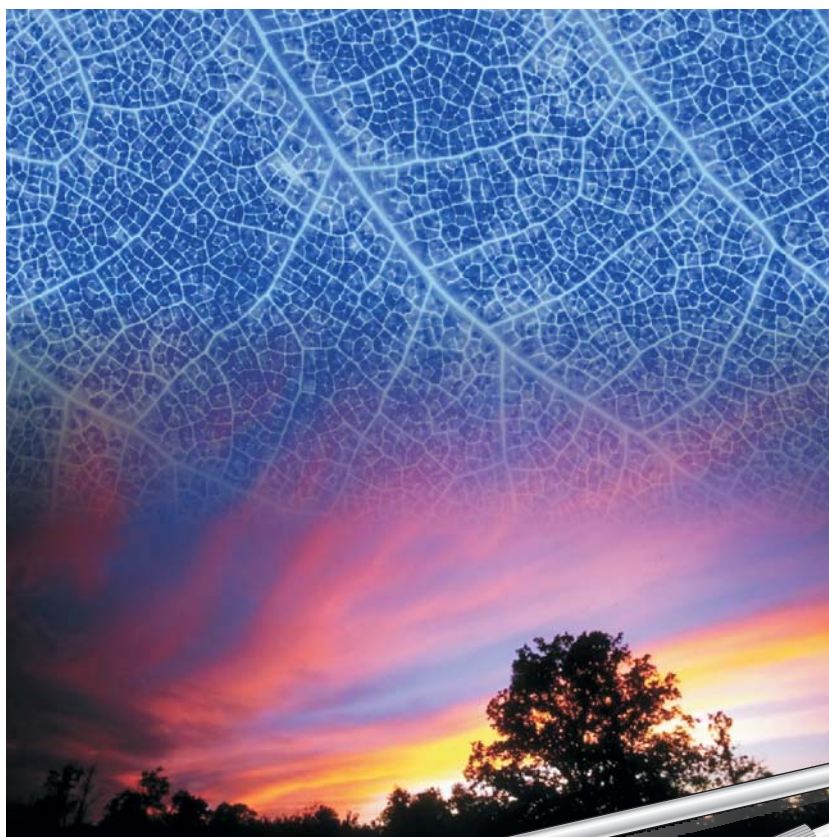
Valva centrale  
Center blade  
Mittelblatt  
Valve centrale  
Valva central  
95 x 24 mm



BV-246



BV-247



**10**

Trequarti  
Trocars  
Trokare  
Trocarts  
Trócares





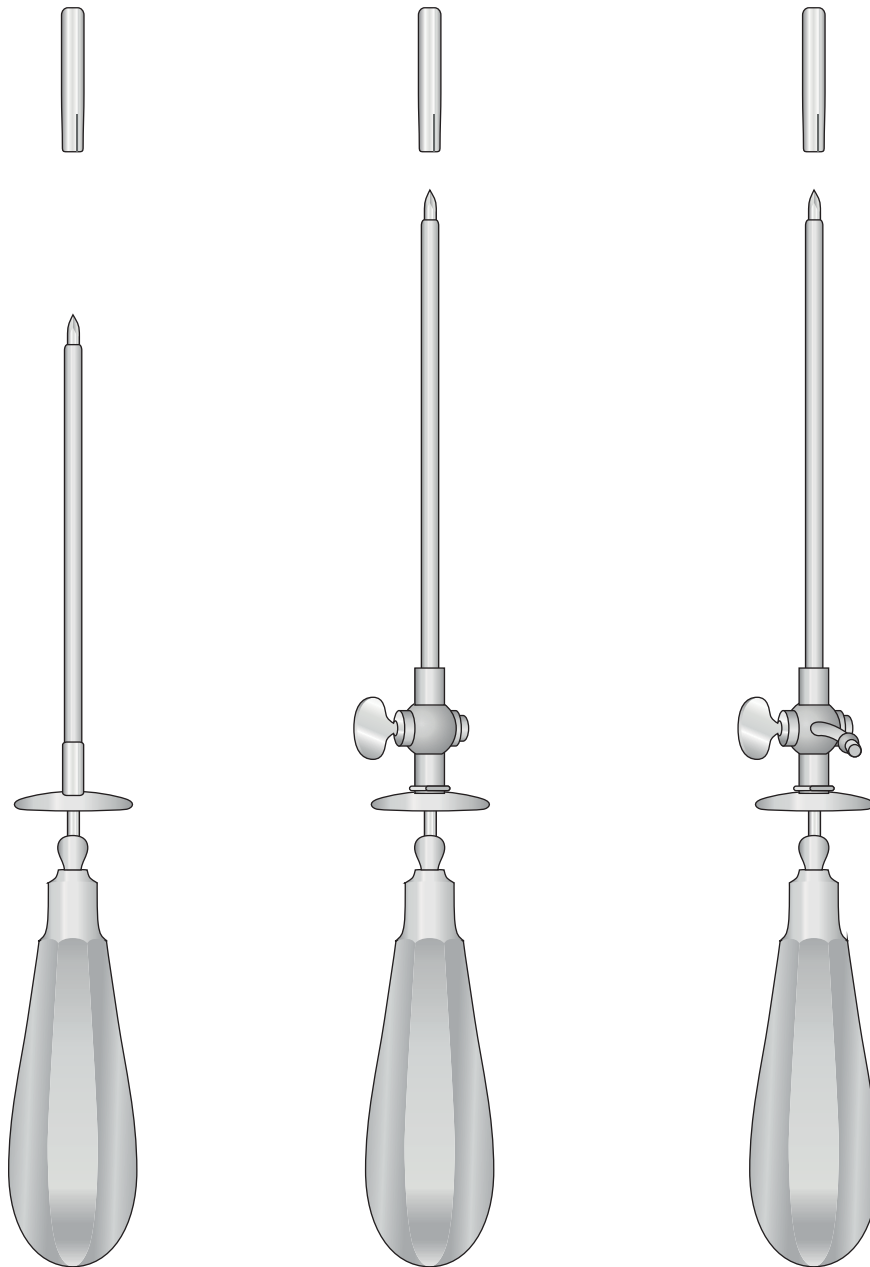
Trequarti

Trocars

Trokare

Trocarts

Tròcares

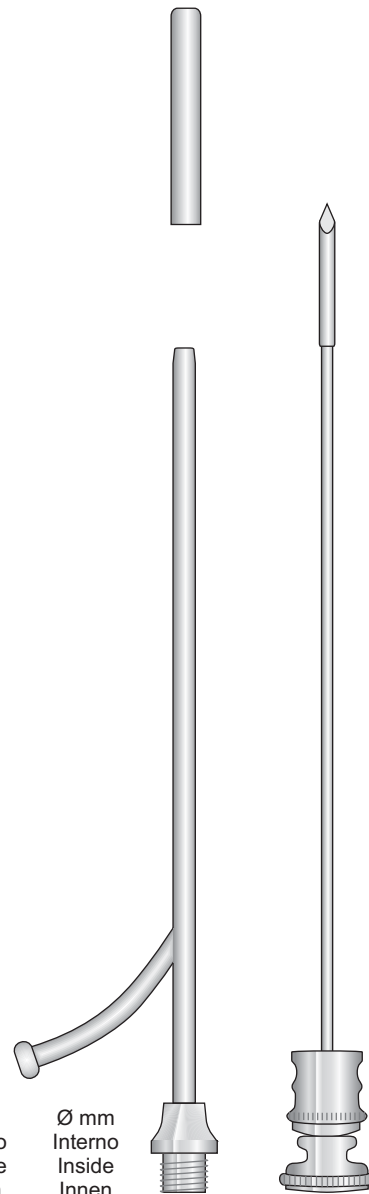
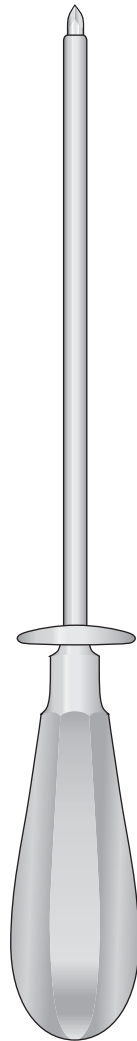
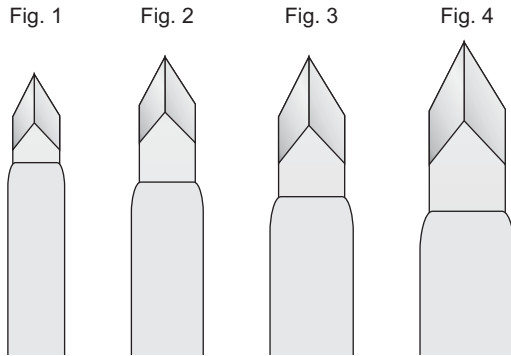


Ø mm Esterno  
 Outside Außen  
 Extérieur Exterior  
 Ø mm Interno  
 Inside Innen  
 Intérieur Interior

		STANDARD	STANDARD	STANDARD
3,0	2,0	<b>TR-40</b>	<b>TR-20</b>	<b>TR-51</b>
3,5	2,5	<b>TR-44</b>	<b>TR-21</b>	<b>TR-52</b>
4,0	3,0	<b>TR-41</b>	<b>TR-22</b>	<b>TR-53</b>
4,5	3,5	<b>TR-45</b>	<b>TR-23</b>	<b>TR-54</b>
5,0	4,0	<b>TR-42</b>	<b>TR-24</b>	<b>TR-55</b>
5,5	4,5	<b>TR-46</b>	<b>TR-25</b>	<b>TR-56</b>
6,0	5,0	<b>TR-43</b>	<b>TR-26</b>	<b>TR-57</b>
		110 mm	120 mm	120 mm



Per vescica biliare - For gall bladder - Für die gallenblase  
 Pour la vésicule biliaire - Para vesícula biliar



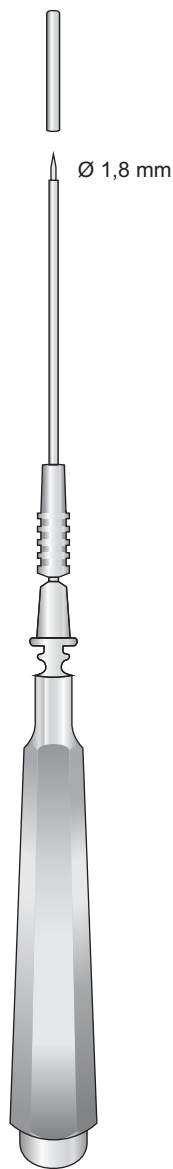
Ø mm Esterno Outside Außen Extérieur Exterior	Ø mm Interno Inside Innen Intérieur Interior		
7,5	6,0	Fig. 1	<b>TR-61</b>
9,5	8,0	Fig. 2	<b>TR-62</b>
11,0	9,5	Fig. 3	<b>TR-63</b>
12,5	11,0	Fig. 4	<b>TR-64</b>
210 mm			

Ø mm Esterno Outside Außen Extérieur Exterior	Ø mm Interno Inside Innen Intérieur Interior	
4,0	3,0	<b>GF-120</b>
4,6	3,6	<b>GF-121</b>
5,3	4,3	<b>GF-122</b>
6,0	5,0	<b>GF-123</b>
210 mm		

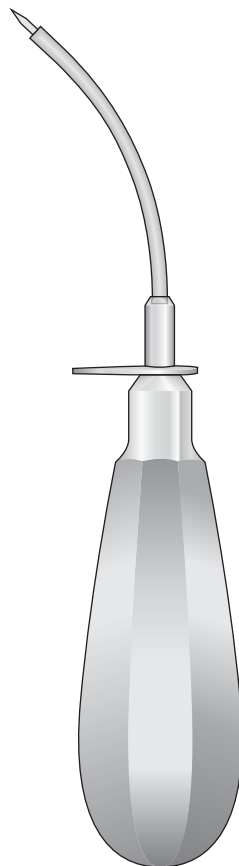




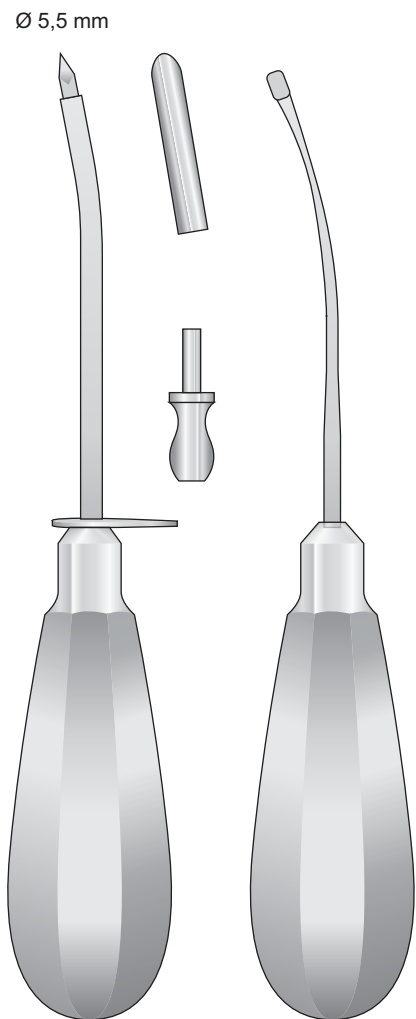
Trequarti per seno mascellare  
 Antrum puncture trocars  
 Kieferhöhlentrokare  
 Trocarts pour sinus maxillaire  
 Trócares para punción del seno maxilar



LICHTWITZ  
**TR-30**  
 190 mm



PIERCE  
**TR-32** Ø 3 mm  
**TR-33** Ø 4 mm  
**TR-34** Ø 5 mm  
 160 mm

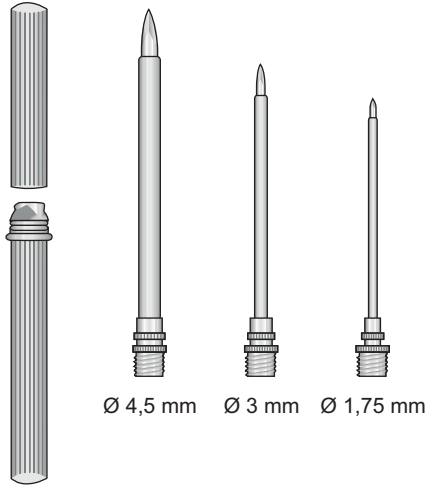


Set completo Krause  
 Krause set complete  
 Krause Komplettsset  
 Set complet Krause  
 Set completo Krause

**KRAUSE**  
**TR-35**  
 160 mm

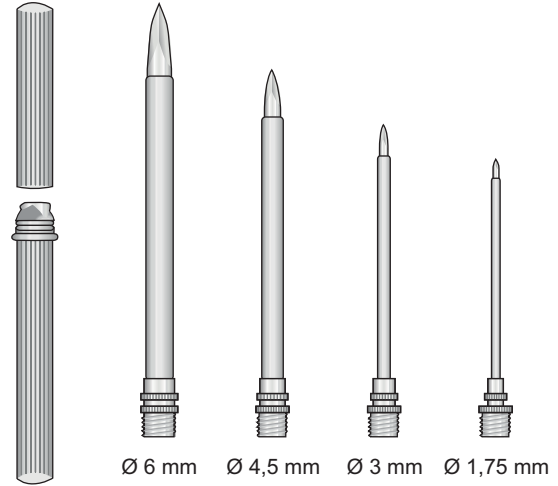


Universale completo con 3 punte  
 Set of 3 pieces  
 Satz zu 3 Stück  
 Jeu de 3 pièces  
 Juego de 3 piezas



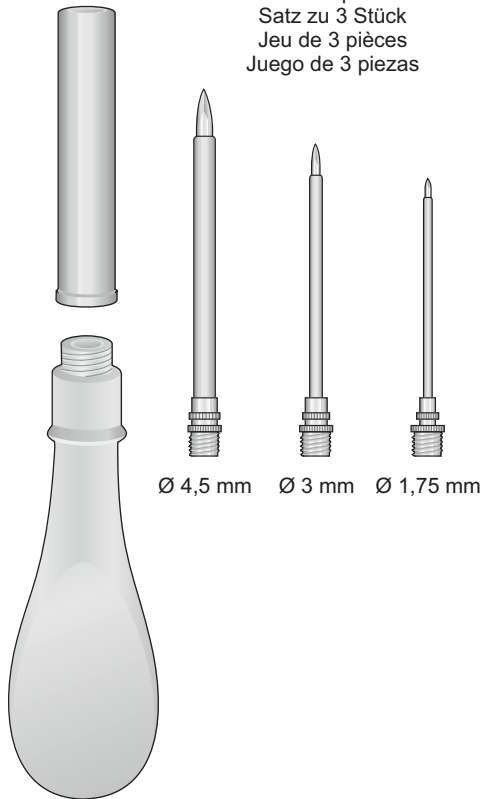
**UNIVERSAL  
TR-47**

Universale completo con 4 punte  
 Set of 4 pieces  
 Satz zu 4 Stück  
 Jeu de 4 pièces  
 Juego de 4 piezas



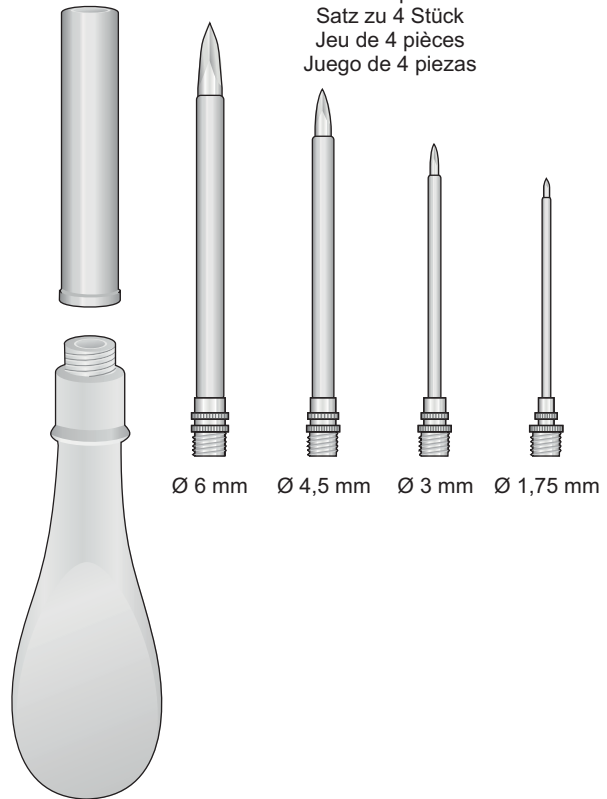
**UNIVERSAL  
TR-48**

Universale completo con 3 punte  
 Set of 3 pieces  
 Satz zu 3 Stück  
 Jeu de 3 pièces  
 Juego de 3 piezas

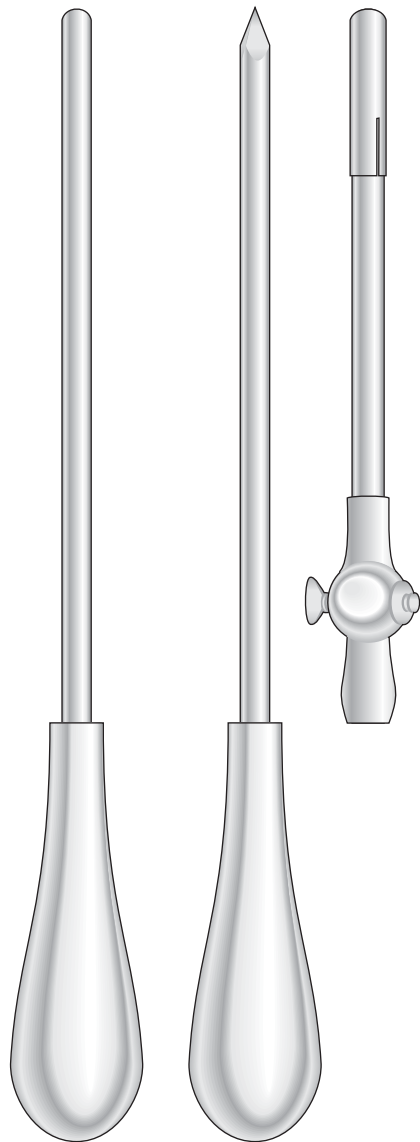


**TR-49  
130 mm**

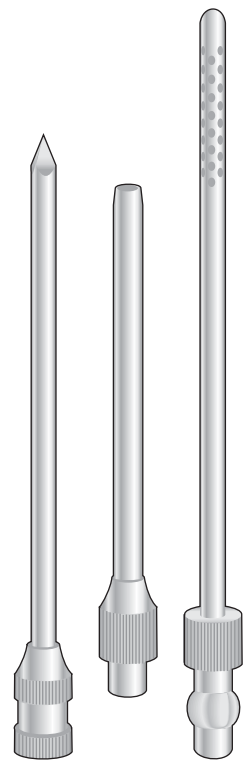
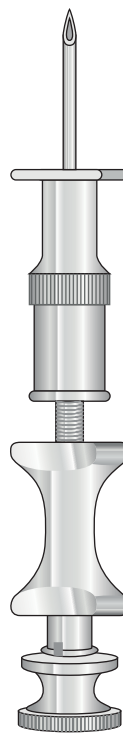
Universale completo con 4 punte  
 Set of 4 pieces  
 Satz zu 4 Stück  
 Jeu de 4 pièces  
 Juego de 4 piezas



**TR-50  
130 mm**



Ago per la puntura dello sterno  
Sternal puncture needle  
Sternal-Punktionskanülen  
Aiguilles pour la ponction sternale  
Agujas para punción esternal



Ø mm	Ø mm
Esterno	Interno
Outside	Inside
Außen	Innen
Extérieur	Intérieur
Exterior	Interior

BUELAU

8	6,5	<b>TR-68</b>
10	8,5	<b>TR-69</b>

240 mm

KLIMA-ROSEGGER

**OL-40**

1,80 x 35 mm

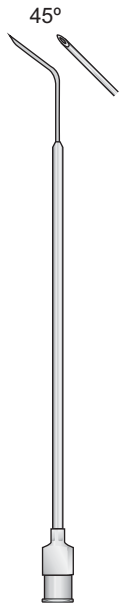
DUKE

**GF-106**

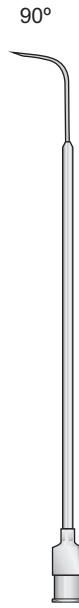
110 mm - 5,5 mm



**OL-01**  
120 mm



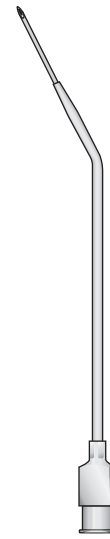
**OL-02**  
110 mm



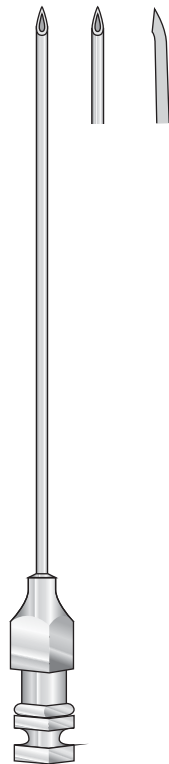
**OL-03**  
110 mm



**OL-04**  
110 mm



**OL-05**  
110 mm



**TUOHY**  
**OL-41** - 1,30 x 80 mm  
**OL-42** - 1,50 x 80 mm  
**OL-43** - 1,65 x 80 mm



**QUINKE**  
**OL-44** - 0,70 x 80 mm  
**OL-45** - 0,70 x 90 mm  
**OL-46** - 1,00 x 80 mm  
**OL-47** - 1,00 x 90 mm  
**OL-48** - 1,20 x 90 mm  
**OL-49** - 1,20 x 100 mm



11

Elevatori, Raspatori, Cucchiari  
Periosteal Elevators, Curettes  
Raspatorien, Löffel  
Rugines, Raspatoires, Curettes  
Periostotomos, Cucharillas





Elevatori

Elevators

Elevatorenien

Elevateurs

Elevadores

6 mm



8 mm

**DO-242**  
135 mm

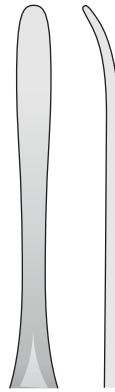
8 mm



10 mm

**DO-243**  
135 mm

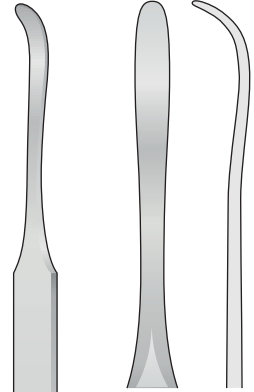
4,5 mm



1/1

**KÖNIG  
KO-1**  
155 mm

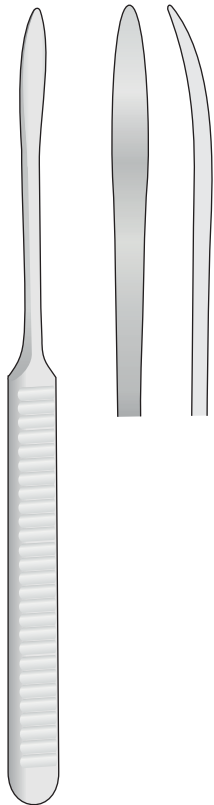
4,5 mm



1/1

**KÖNIG  
KO-2**  
155 mm

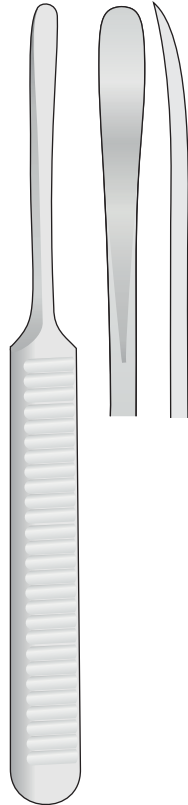
5 mm



1/1

**WILLIGER  
WG-10**  
165 mm

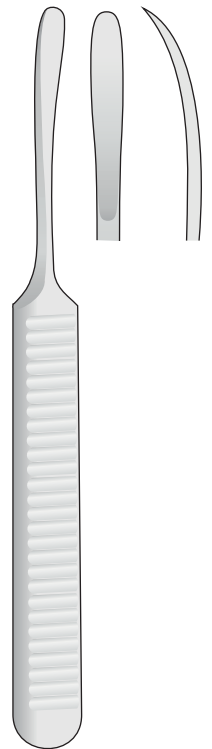
6 mm



1/1

**WILLIGER  
WG-12**  
160 mm

4 mm



1/1

**WILLIGER  
WG-14**  
140 mm

Periostotomi  
Periosteal Raspatories  
Raspatorien  
Rugines à périostomie  
Legras periostotomos



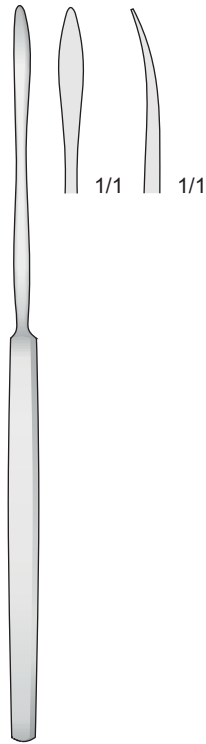
Dissettori  
Separatori

Dissectors  
Seperators

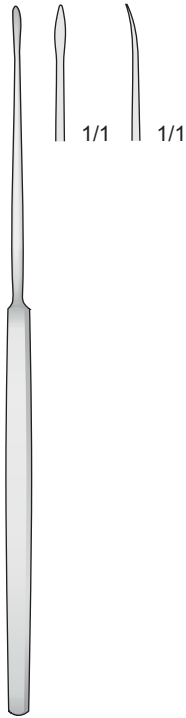
Dissektoren  
Separatoren

Dissecteurs  
Separateurs

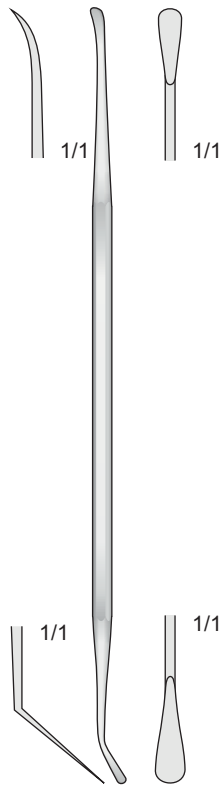
Disecadores  
Descoladores



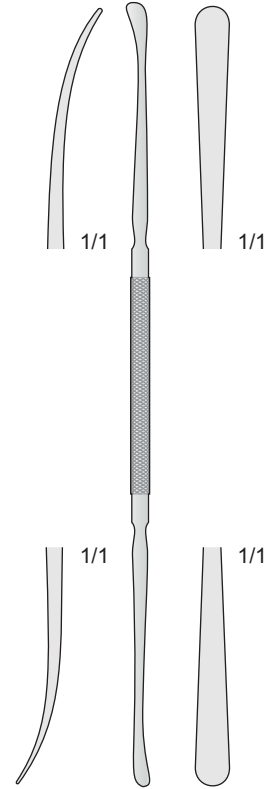
**KO-18**  
175 mm



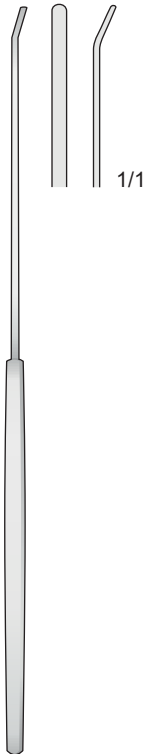
**KO-19**  
160 mm



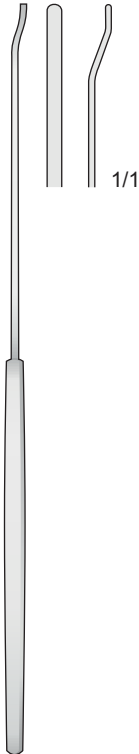
**MILLIGAN  
KO-27**  
210 mm



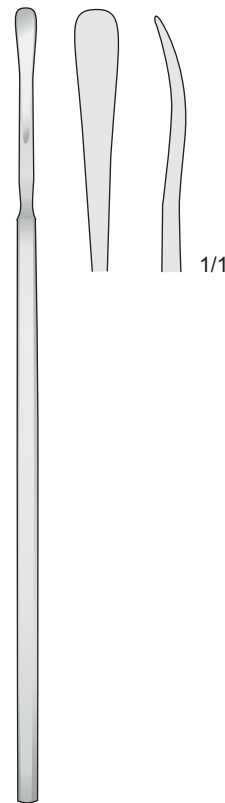
**DAVIS  
KO-21**  
245 mm



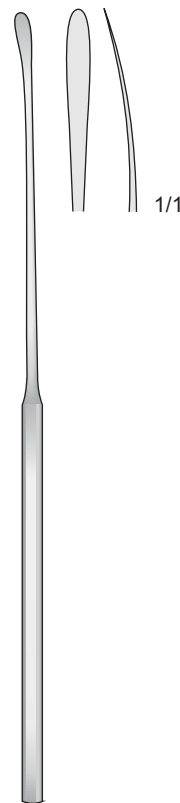
**FAGER  
KO-24**  
200 mm



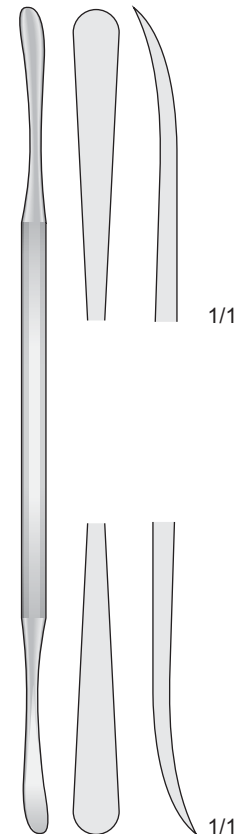
**FAGER  
KO-25**  
200 mm



**SACHS  
KO-26**  
210 mm



**SACHS  
KO-28**  
210 mm



**KO-29**  
220 mm





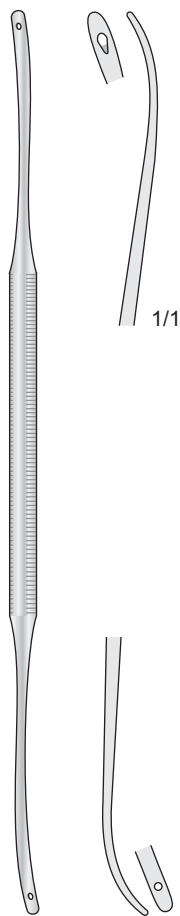
Dissettori  
Separatori

Dissectors  
Seperators

Dissektoren  
Separatoren

Dissecteurs  
Separateurs

Disecadores  
Descoladores

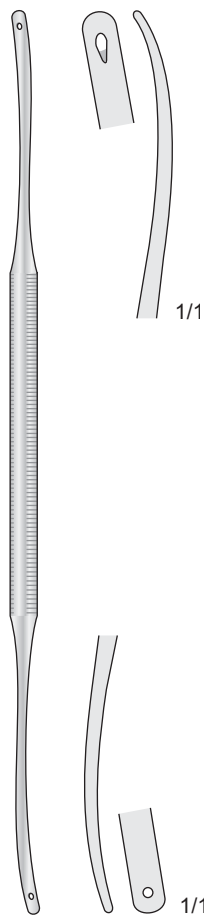


Fine  
Fein  
Fin  
Fino  
Fin

1/1

1/1

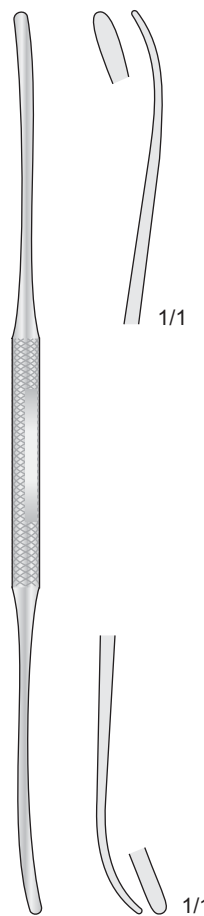
**KO-14** - 180 mm  
**KO-15** - 240 mm



1/1

1/1

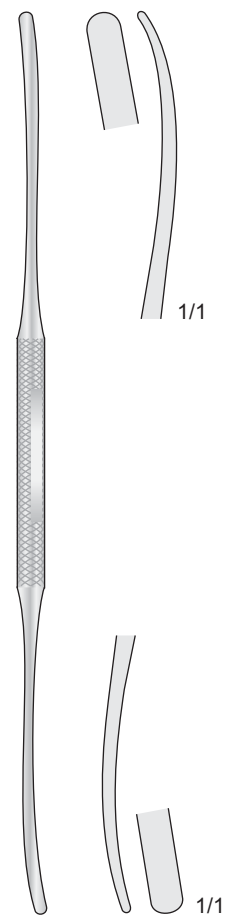
**KO-16** - 180 mm  
**KO-17** - 240 mm



1/1

1/1

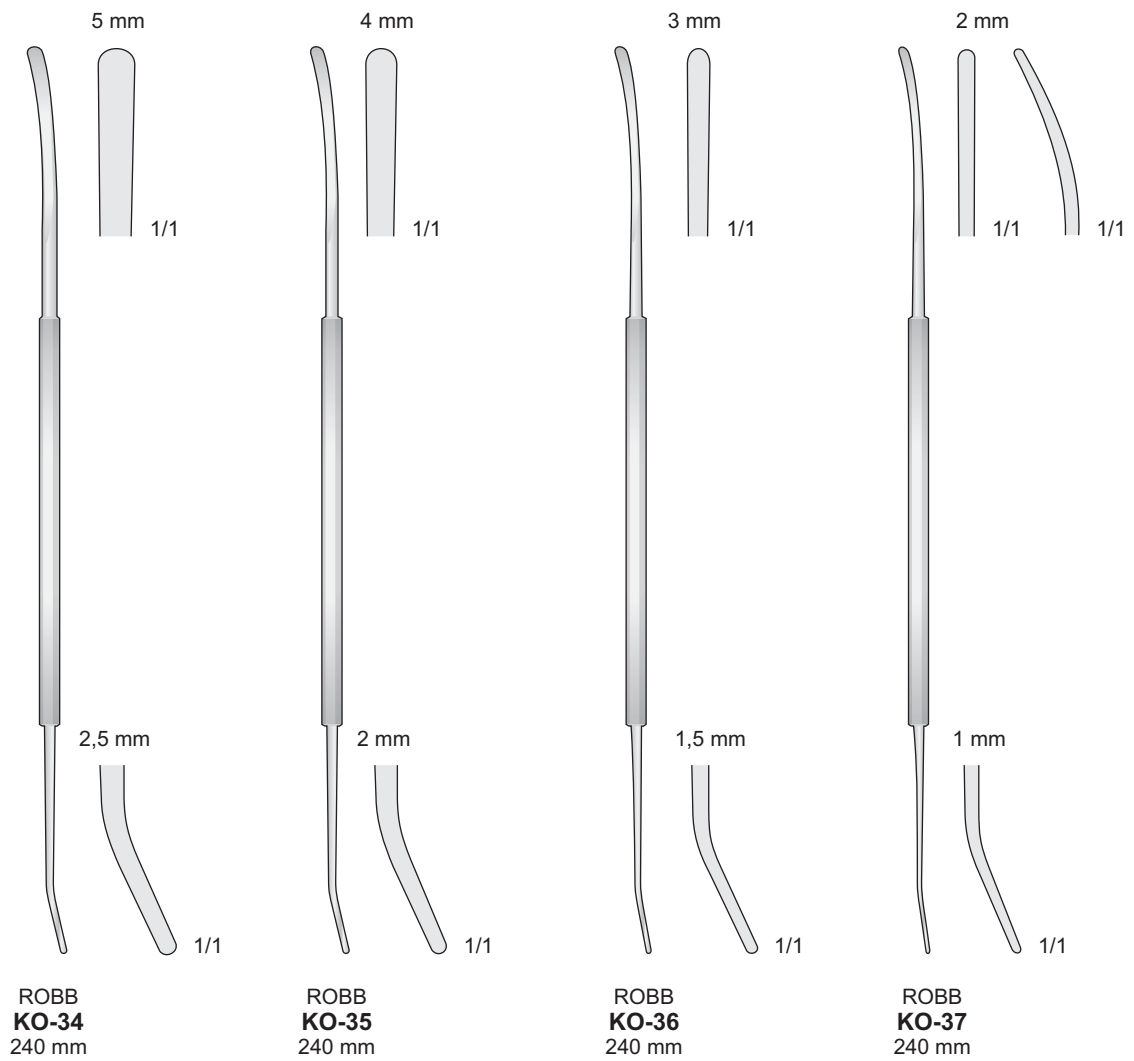
OLIVECRONA  
**KO-47** - 180mm  
**KO-48** - 240mm



1/1

1/1

OLIVECRONA  
**KO-49** - 195mm  
**KO-50** - 240mm





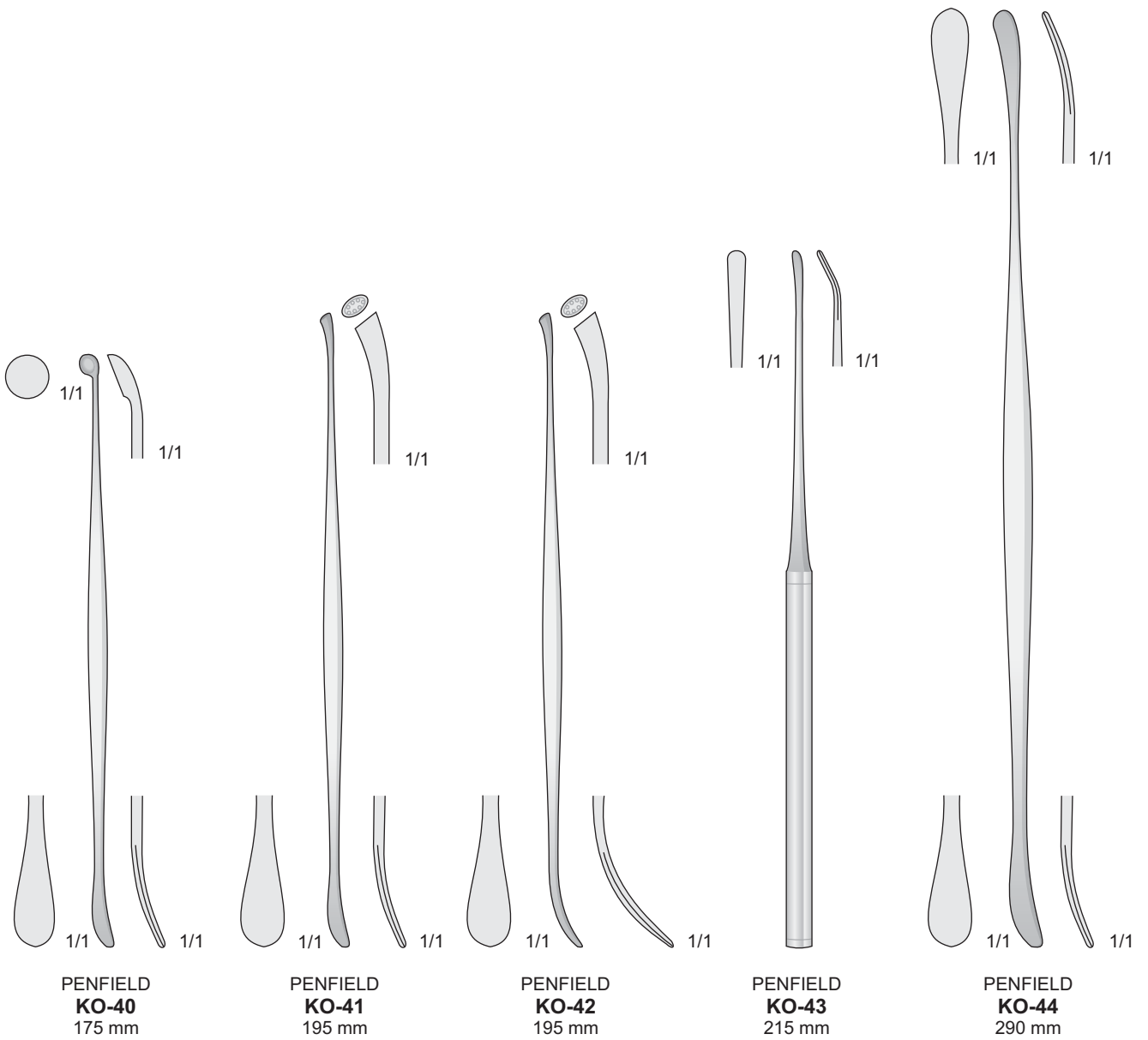
Dissettori

Dissectors

Dissektoren

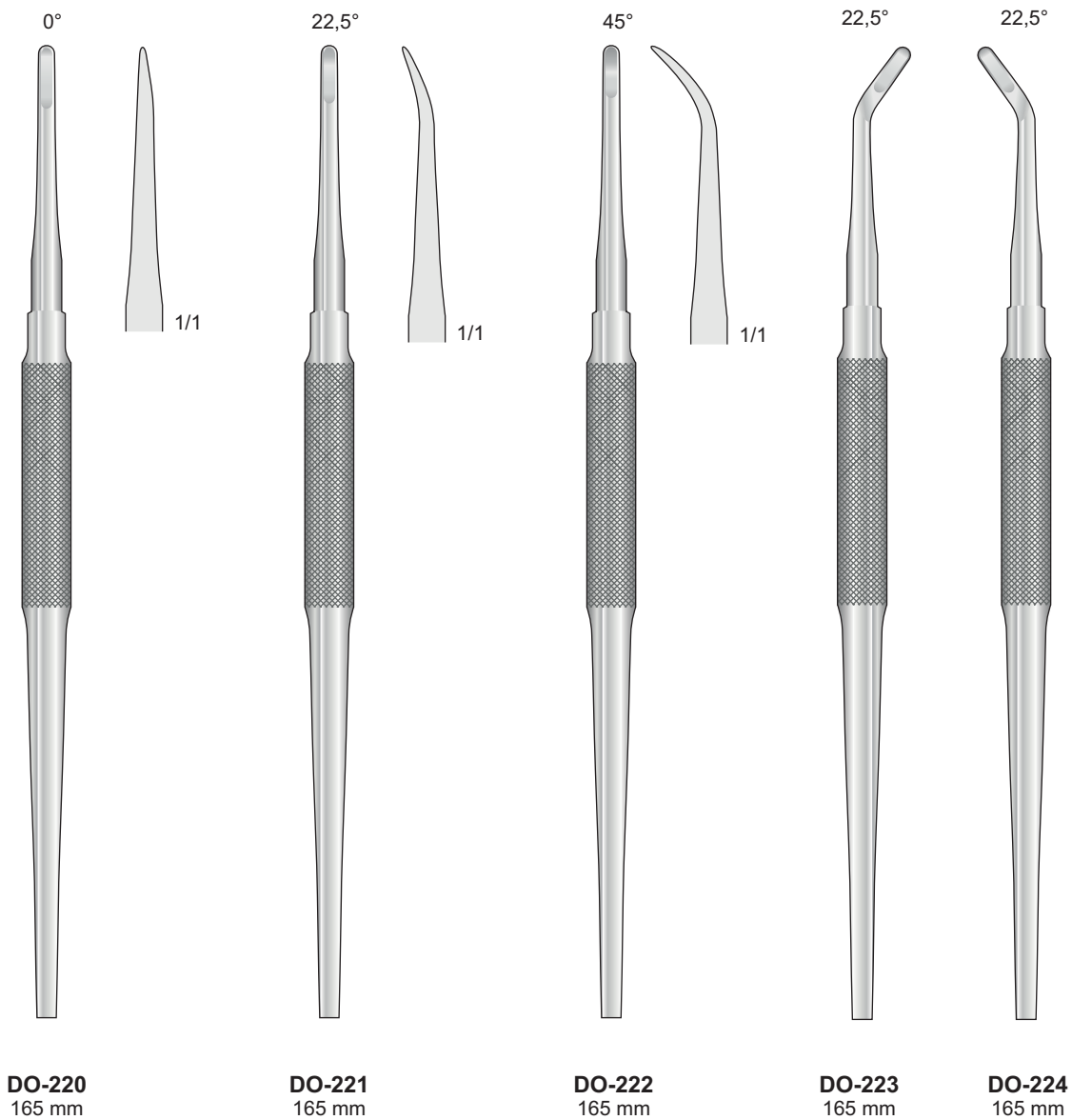
Dissecteurs

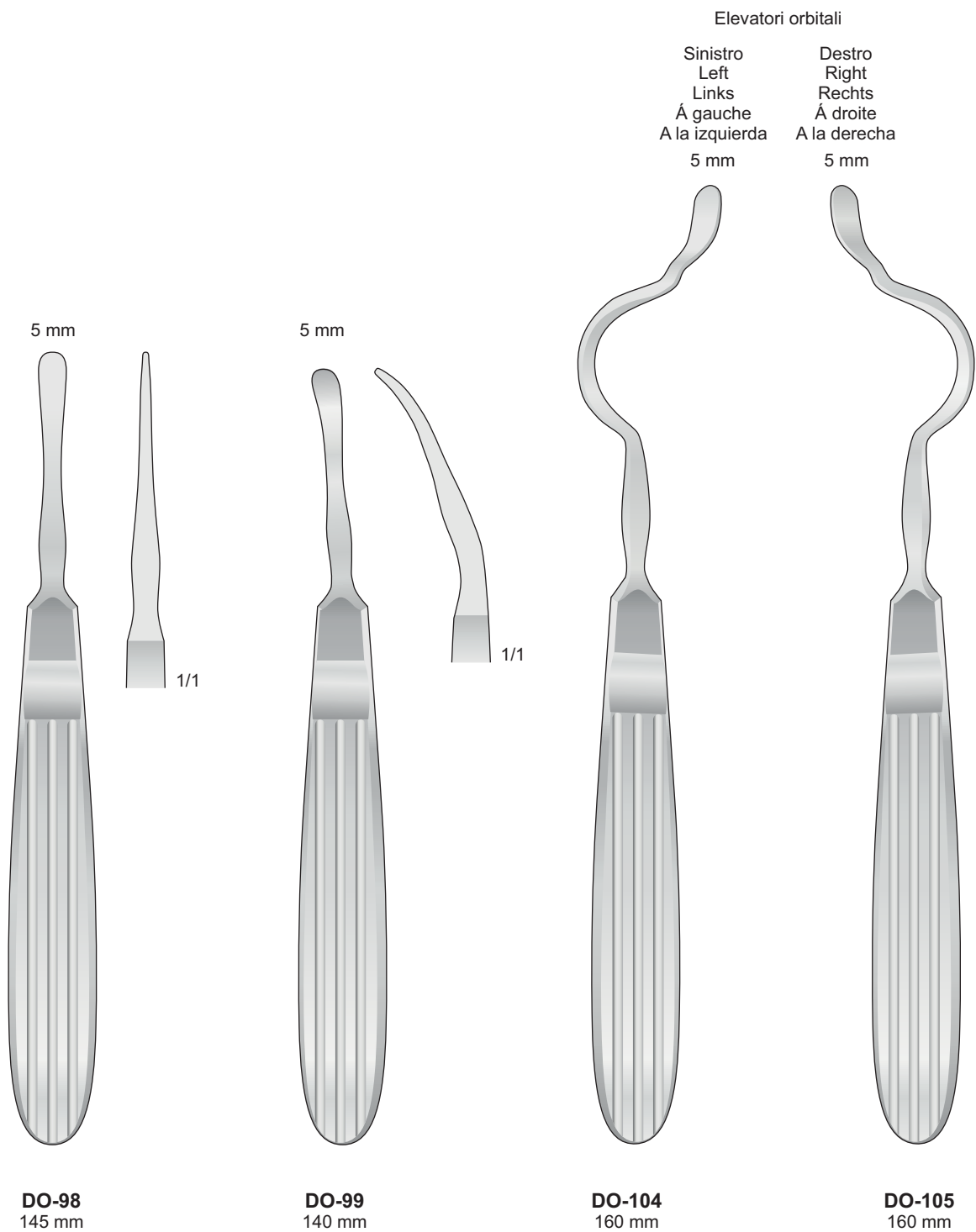
Disecadores

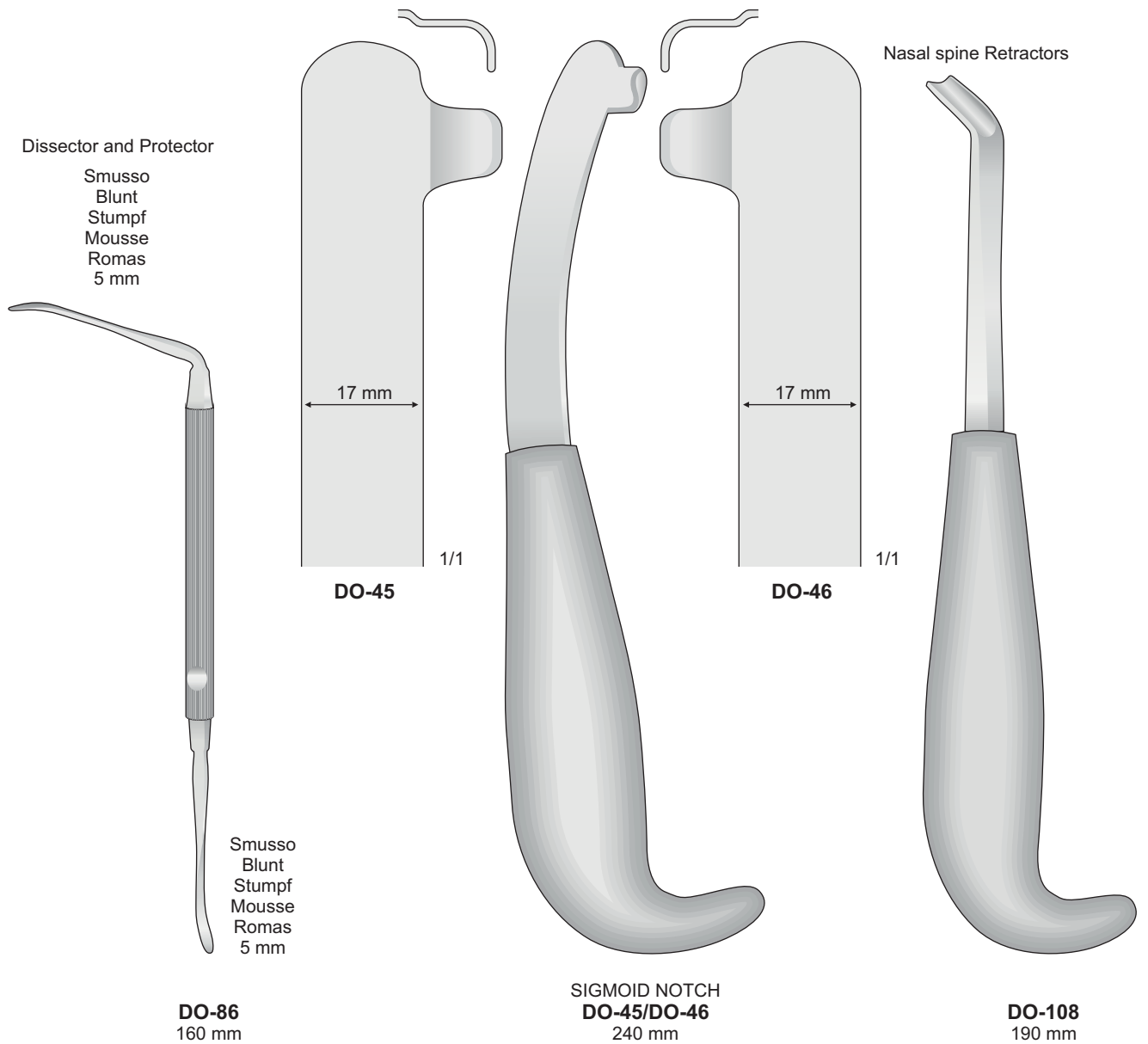




Nerve and Tissue protectors









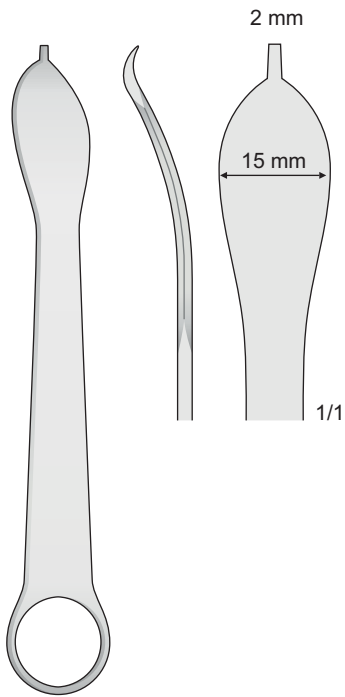
Elevatori

Elevators

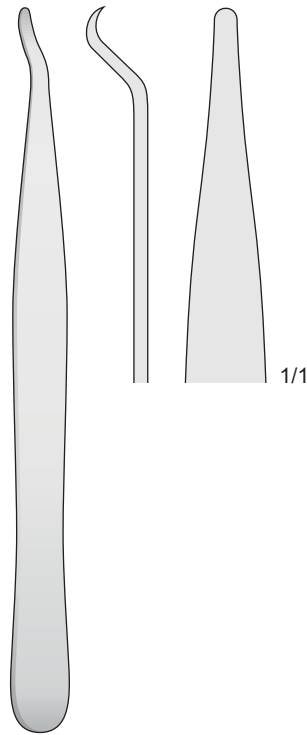
Elevatorien

Elevateurs

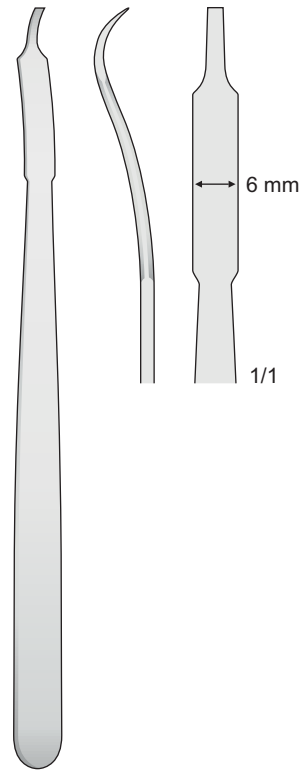
Elevadores



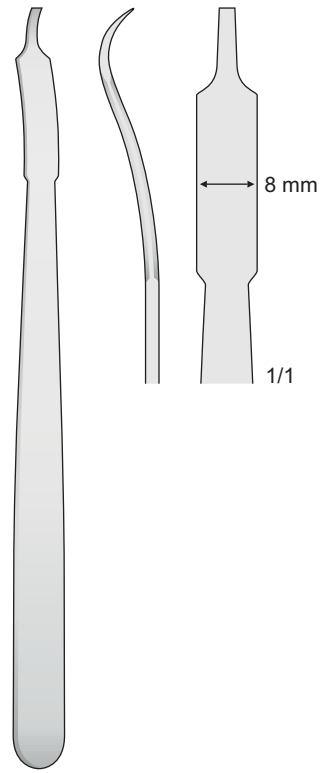
**FK-45**  
120 mm



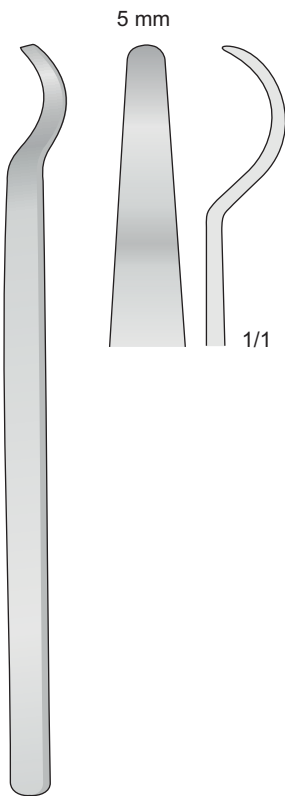
**FK-46**  
140 mm



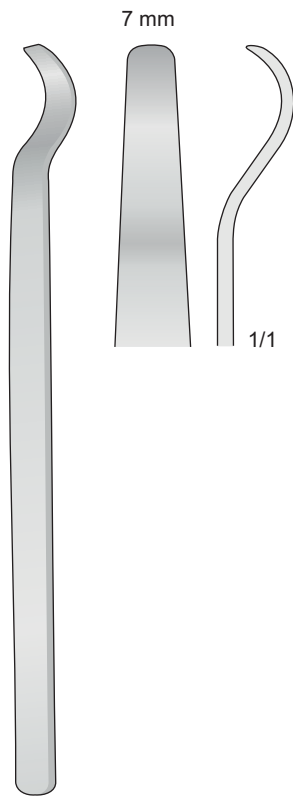
MINI-HOHMANN  
**FK-48**  
160 mm



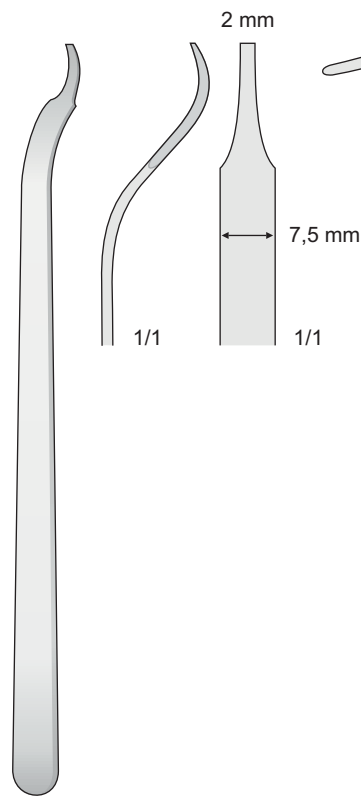
MINI-HOHMANN  
**FK-49**  
160 mm



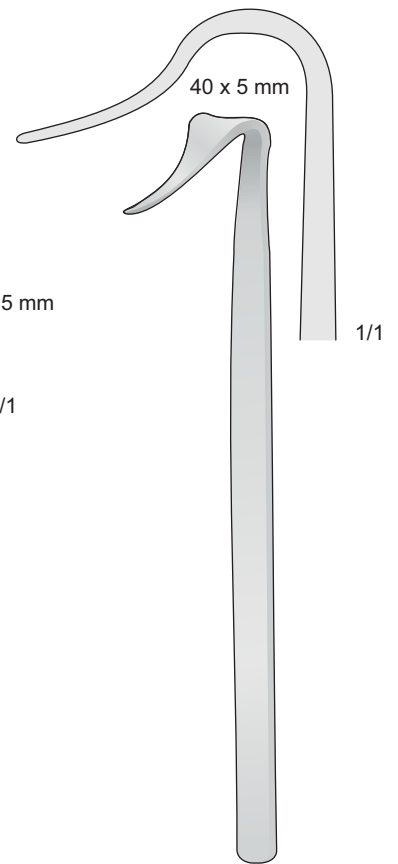
**FK-30**  
150 mm



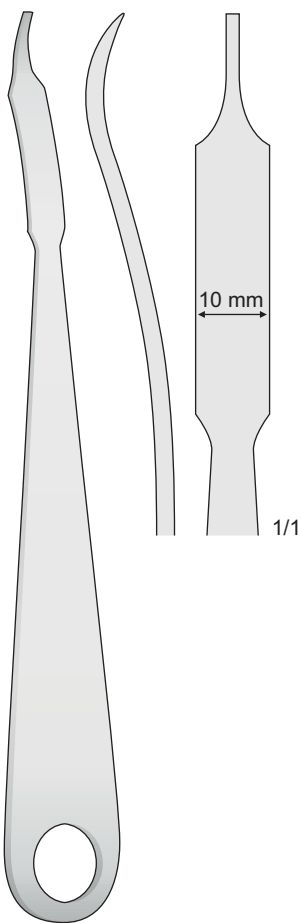
**FK-28**  
150 mm



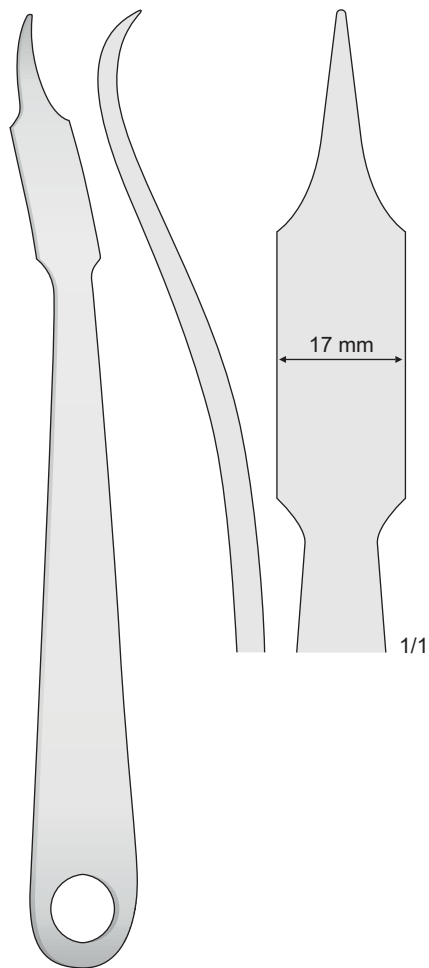
BUCK-GRAMCKO  
**FK-20**  
150 mm



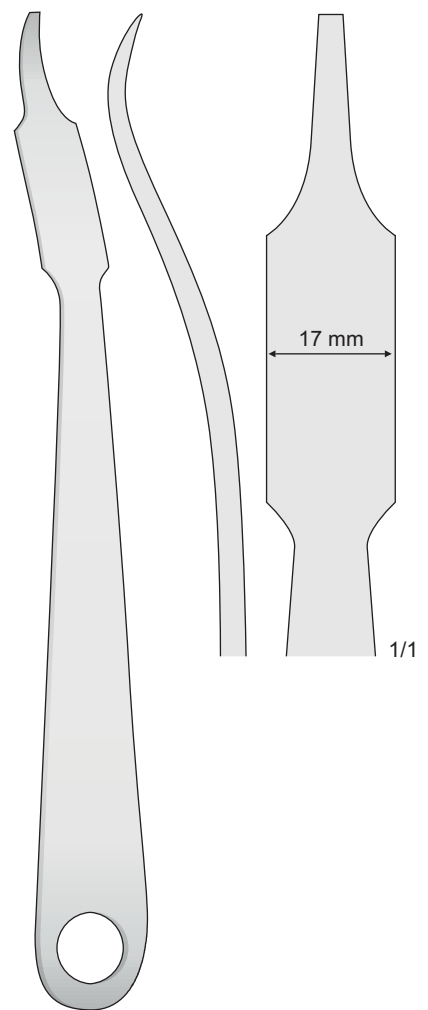
BLOUNT  
**FK-27**  
175 mm



**FK-51**  
220 mm

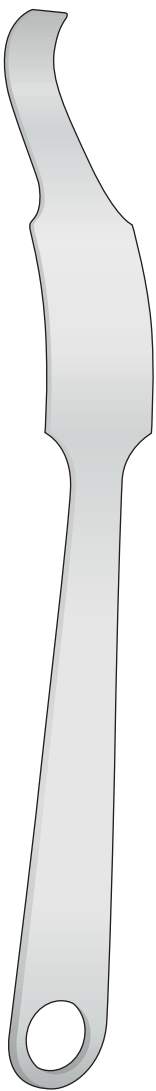


**FK-52**  
240 mm

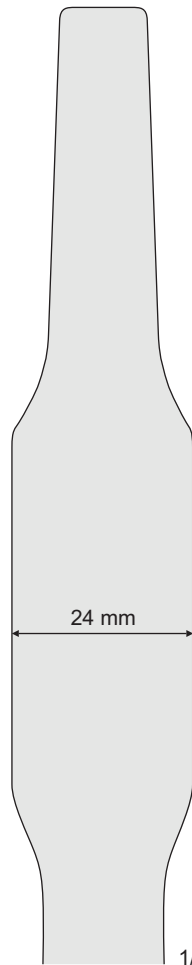
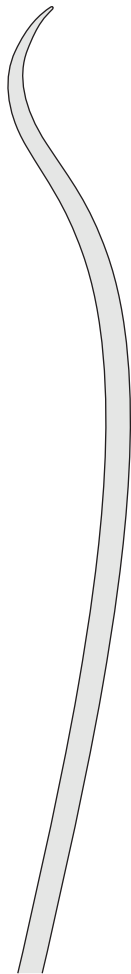


**FK-53**  
240 mm



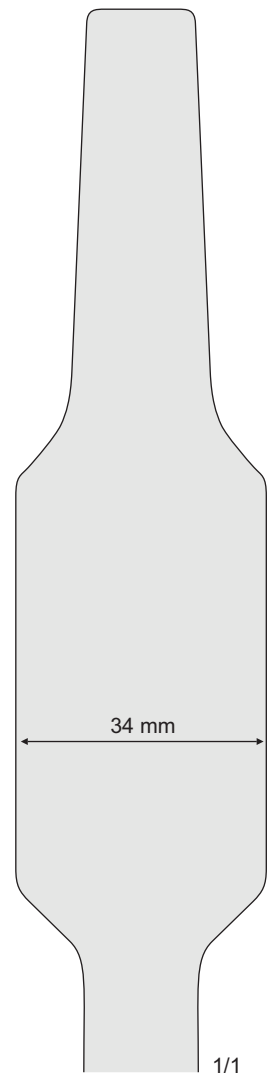


**HOHMANN  
FK-54/FK-55**



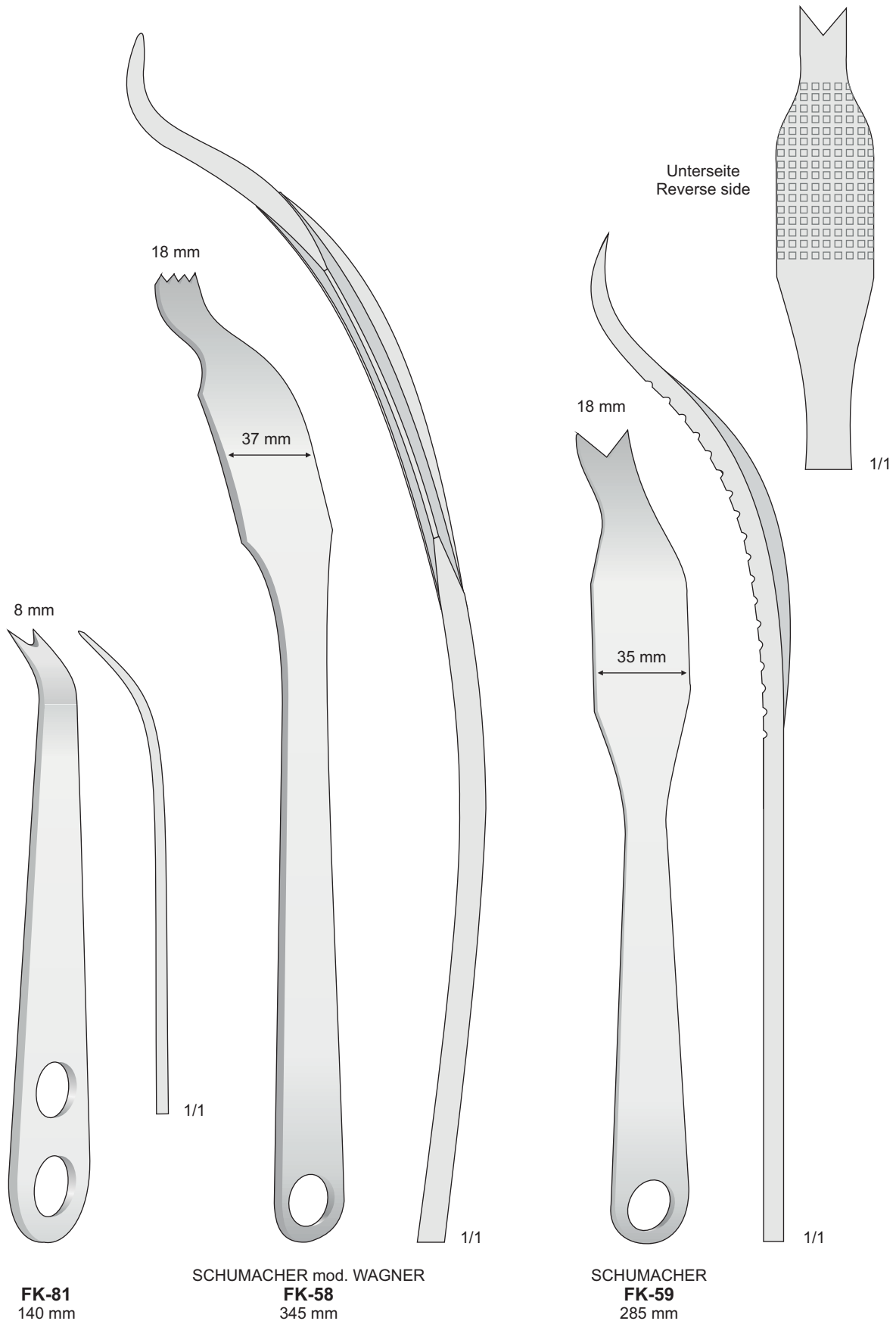
**FK-54  
260 mm**

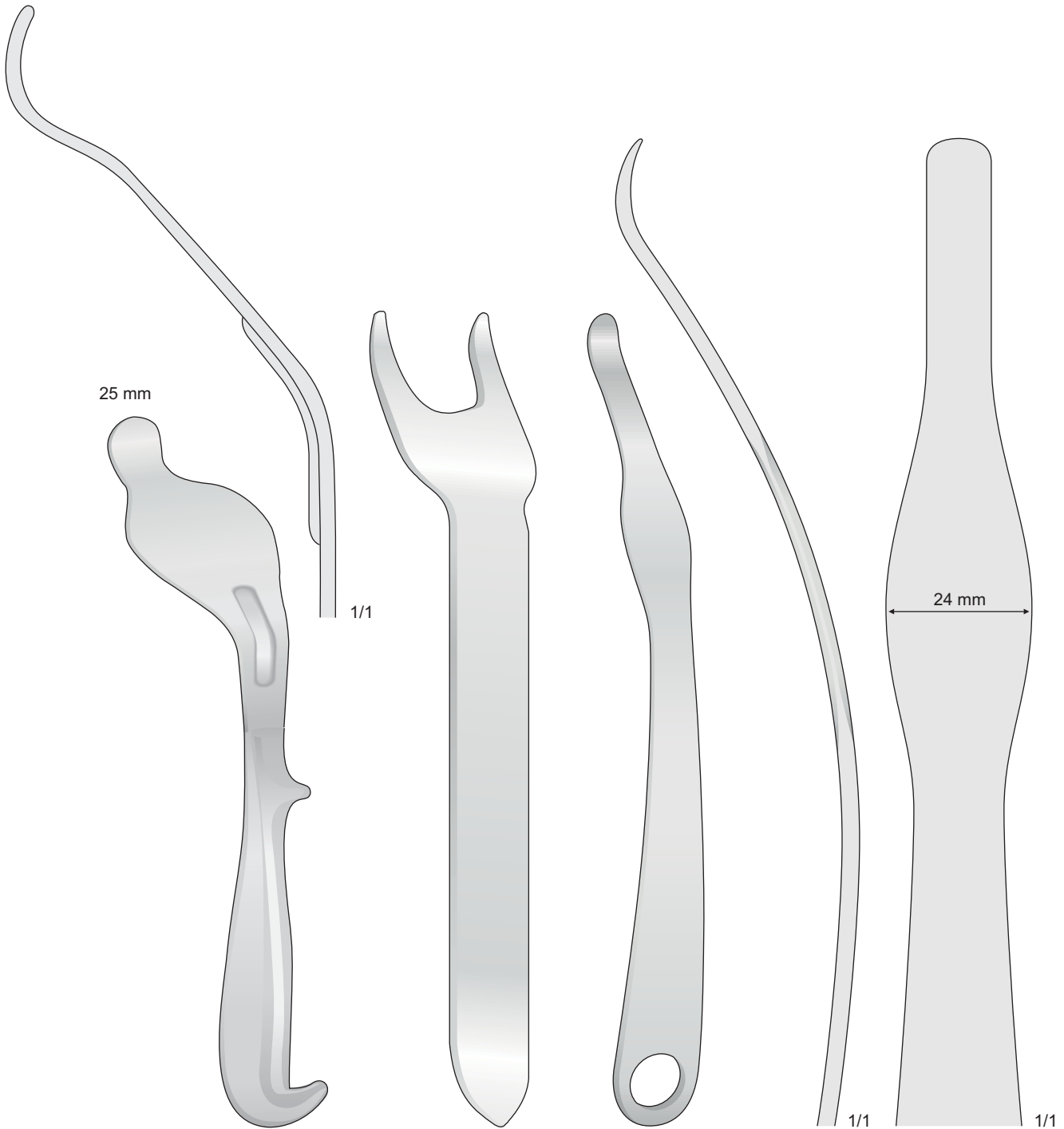
1/1



**FK-55  
285 mm**

1/1





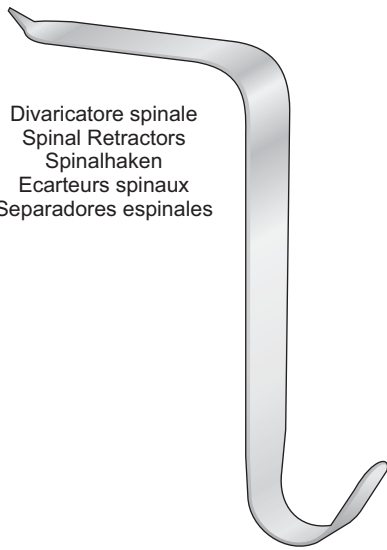
**BENNETT**  
**FK-176** 43 mm  
**FK-179** 60 mm  
240 mm

**BLOUNT**  
**FK-93**  
260 mm

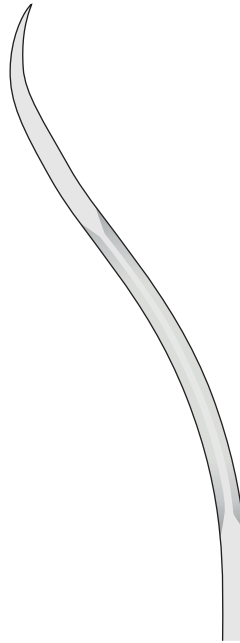
**FK-56**  
260 mm



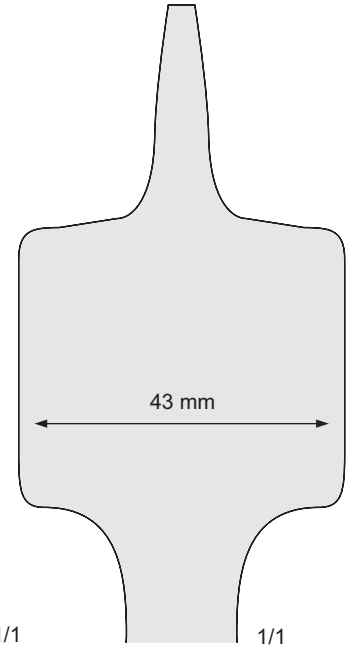
Divaricatore spinale  
Spinal Retractors  
Spinalhaken  
Ecarteurs spinaux  
Separadores espinales



TAYLOR  
**FK-168** 75 x 30 mm  
**FK-169** 100 x 30 mm  
165 mm



1/1

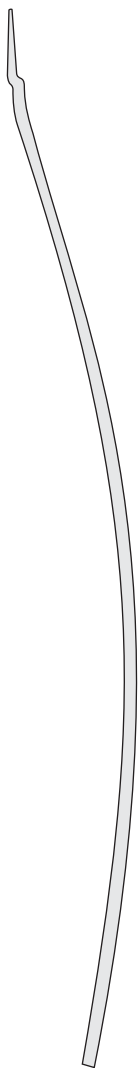


1/1

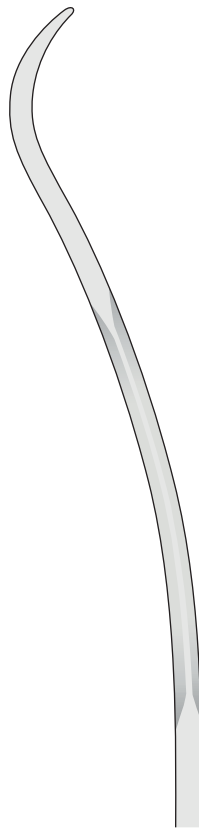
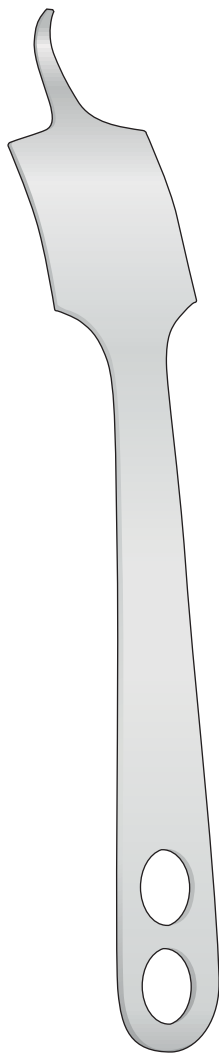
**FK-57**  
240 mm



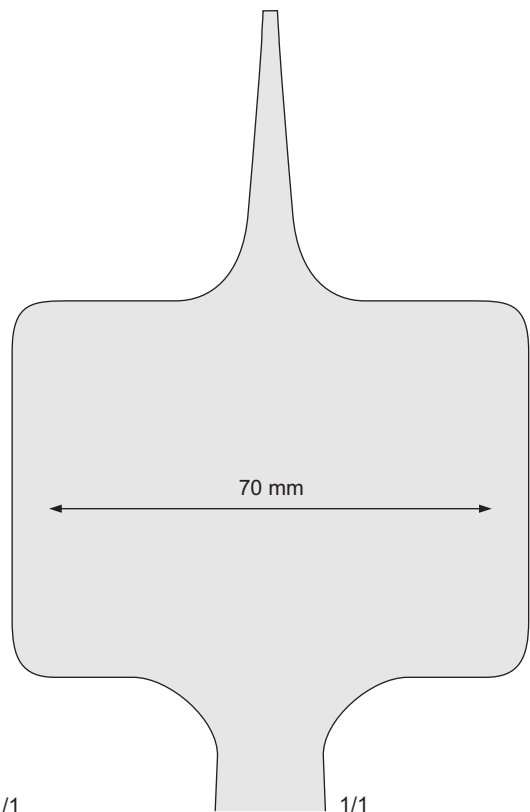
**FK-164**  
250 mm



HOHMANN  
**FK-47/FK-57**  
240 mm



1/1



1/1

**FK-47**  
240 mm



Periostotomi

Periosteal Raspatories

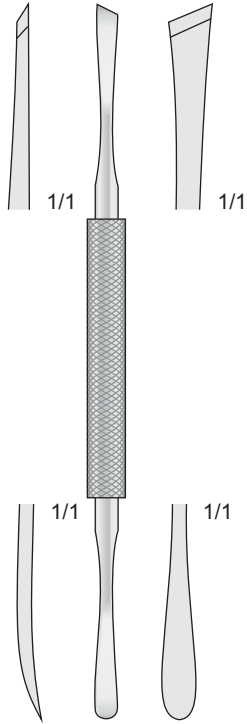
Raspatorien

Rugines à periostomie

Legras periostotomos



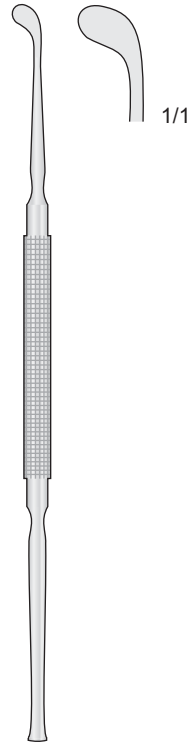
**WEST**  
185 mm



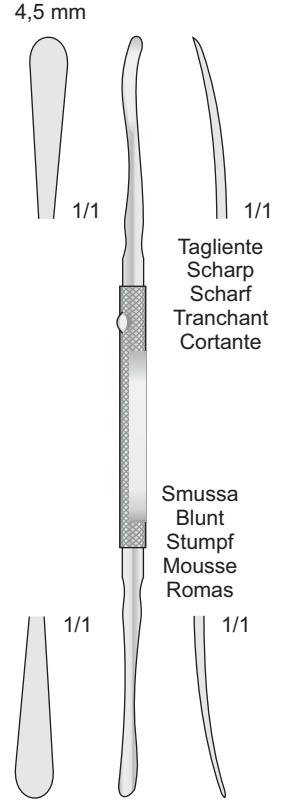
**MEAD**  
165 mm



**ALDERDYCE  
KO-39**  
210 mm



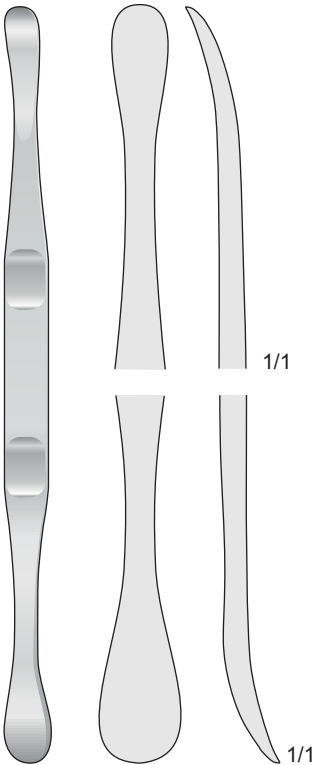
**FREER  
FR-15**  
190 mm



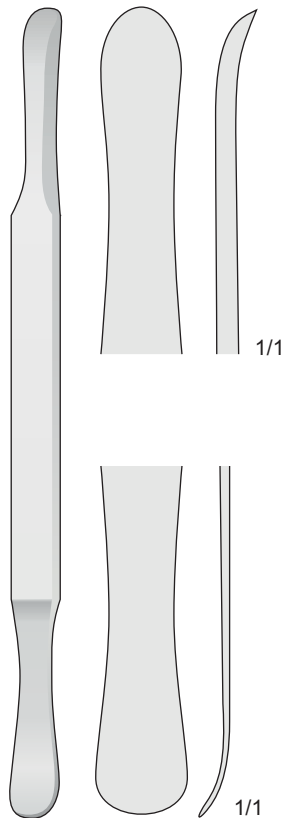
**FREER**  
180 mm

Tagliente  
Scharf  
Tranchant  
Cortante

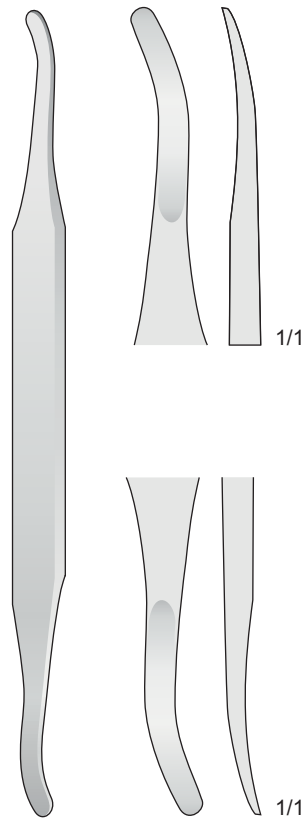
Smussa  
Blunt  
Stumpf  
Mousse  
Romas



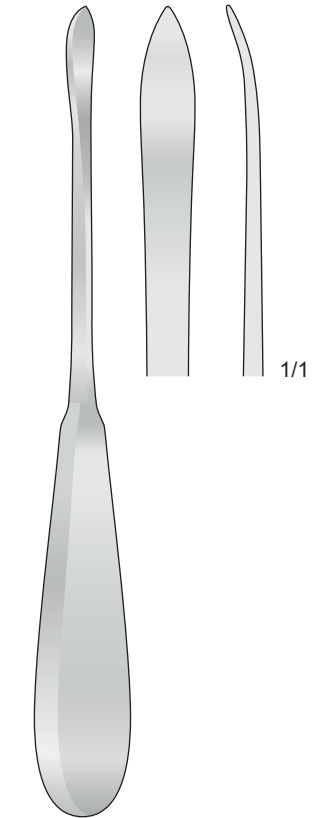
**BABBUSH  
KO-20**  
180 mm



**SELDIN  
KO-23**  
195 mm



**SELDIN  
KO-22**  
190 mm



**LANGENBECK  
FK-12**  
200 mm



Periostotomi

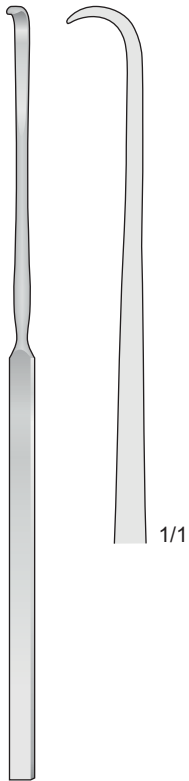
Raspatories

Raspatorien

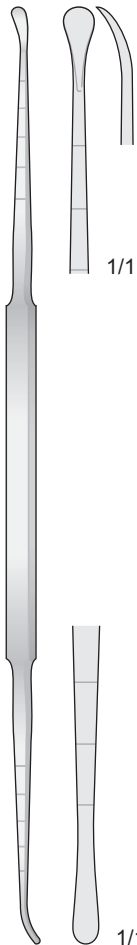
Rugines

Legras

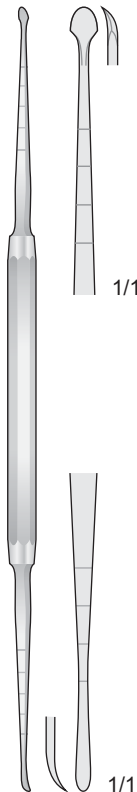
4 mm



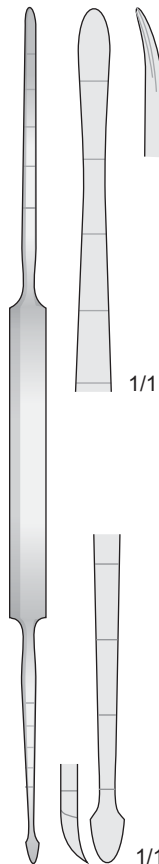
**DO-244**  
200 mm



**COTTLE DO-60**  
220 mm

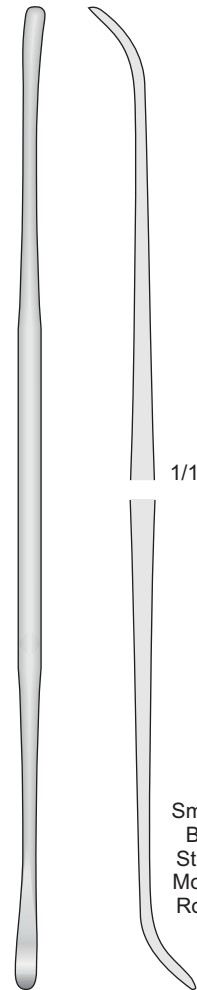


**MASING DO-47**  
210 mm



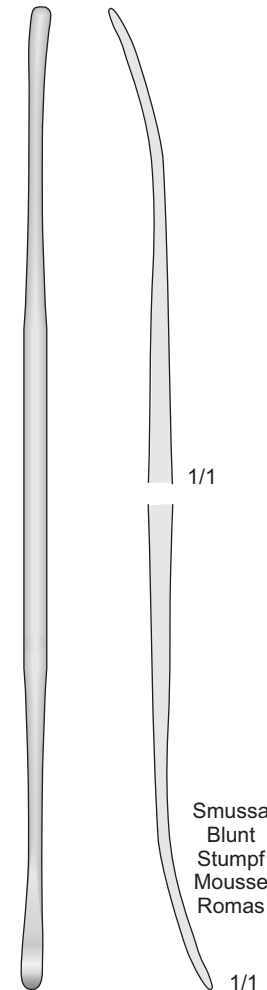
**COTTLE DO-111**  
210 mm

5 mm  
Tagliente  
Sharp  
Scharf  
Tranchant  
Cortante



**SALZBURG DO-240**  
245 mm

5 mm  
Tagliente  
Sharp  
Scharf  
Tranchant  
Cortante



**SALZBURG DO-241**  
245 mm

Smussa  
Blunt  
Stumpf  
Mousse  
Romas

Smussa  
Blunt  
Stumpf  
Mousse  
Romas



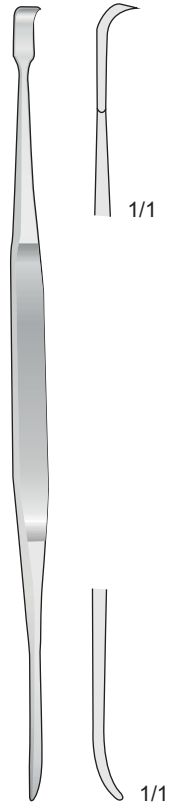
Periostotomi

Raspatories

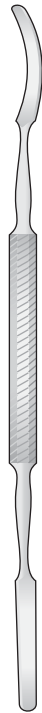
Raspatorien

Rugines

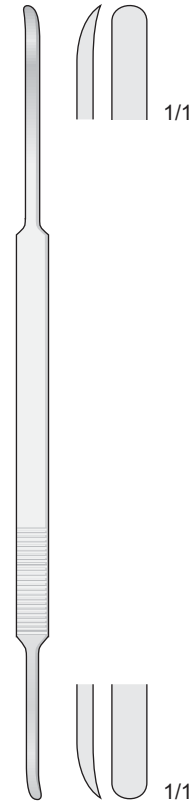
Legras



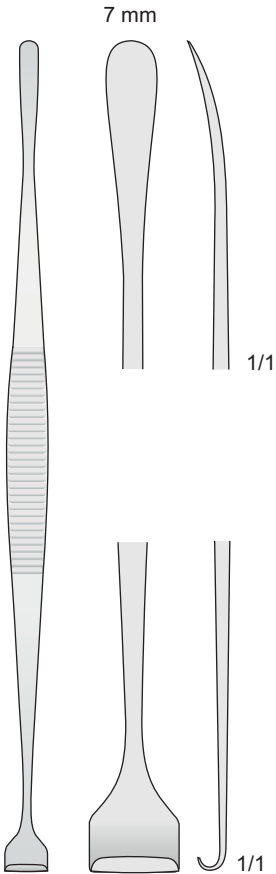
HOWARTH  
KO-30  
210 mm



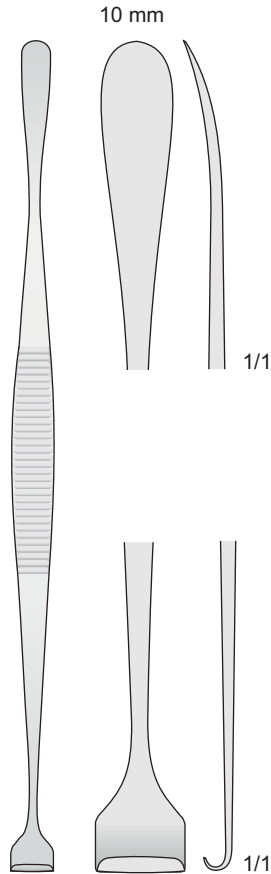
MC DONALD  
KO-38  
190 mm



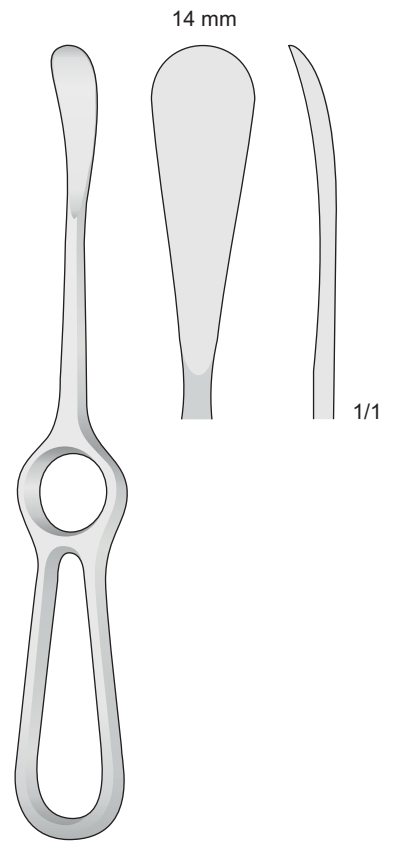
MCKENTY  
KO-46  
220 mm



HURD  
BT-1  
220 mm



HURD  
BT-2  
220 mm

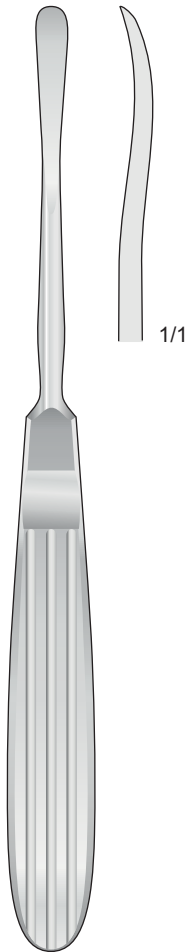


SEDILLOT  
BT-37  
210 mm



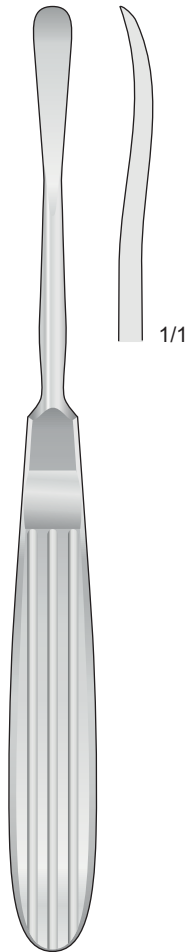
Periosteal elevators  
Taglienti  
Sharp  
Scharf  
Tranchant  
Cortante

6 mm



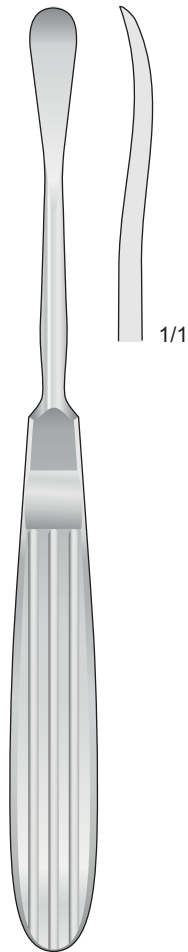
OBWEGESER  
**DO-59**  
175 mm

7 mm



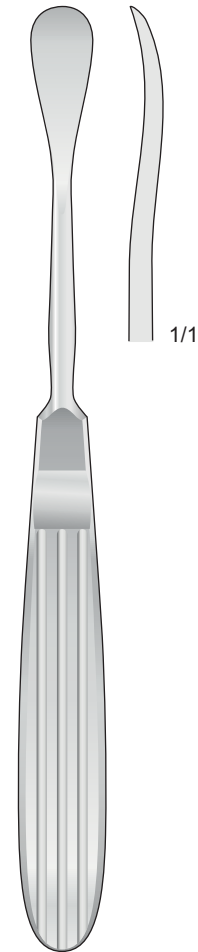
OBWEGESER  
**DO-63**  
175 mm

9 mm



OBWEGESER  
**DO-67**  
175 mm

11 mm



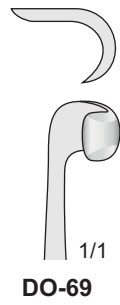
OBWEGESER  
**DO-65**  
175 mm





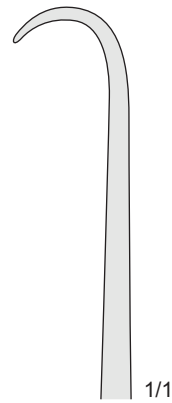
Sinistra, tagliente  
Left, sharp  
Links, Scharf  
À gauche, tranchant  
A la izquierda, cortante

Destra, tagliente  
Right, sharp  
Rechts, Scharf  
À droite, tranchant  
A la derecha, cortante



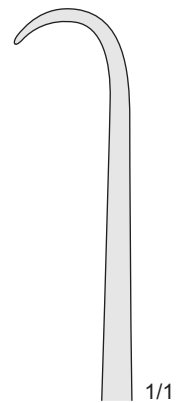
**OBWEGESER**  
**DO-68/DO-69**  
190 mm

5 mm

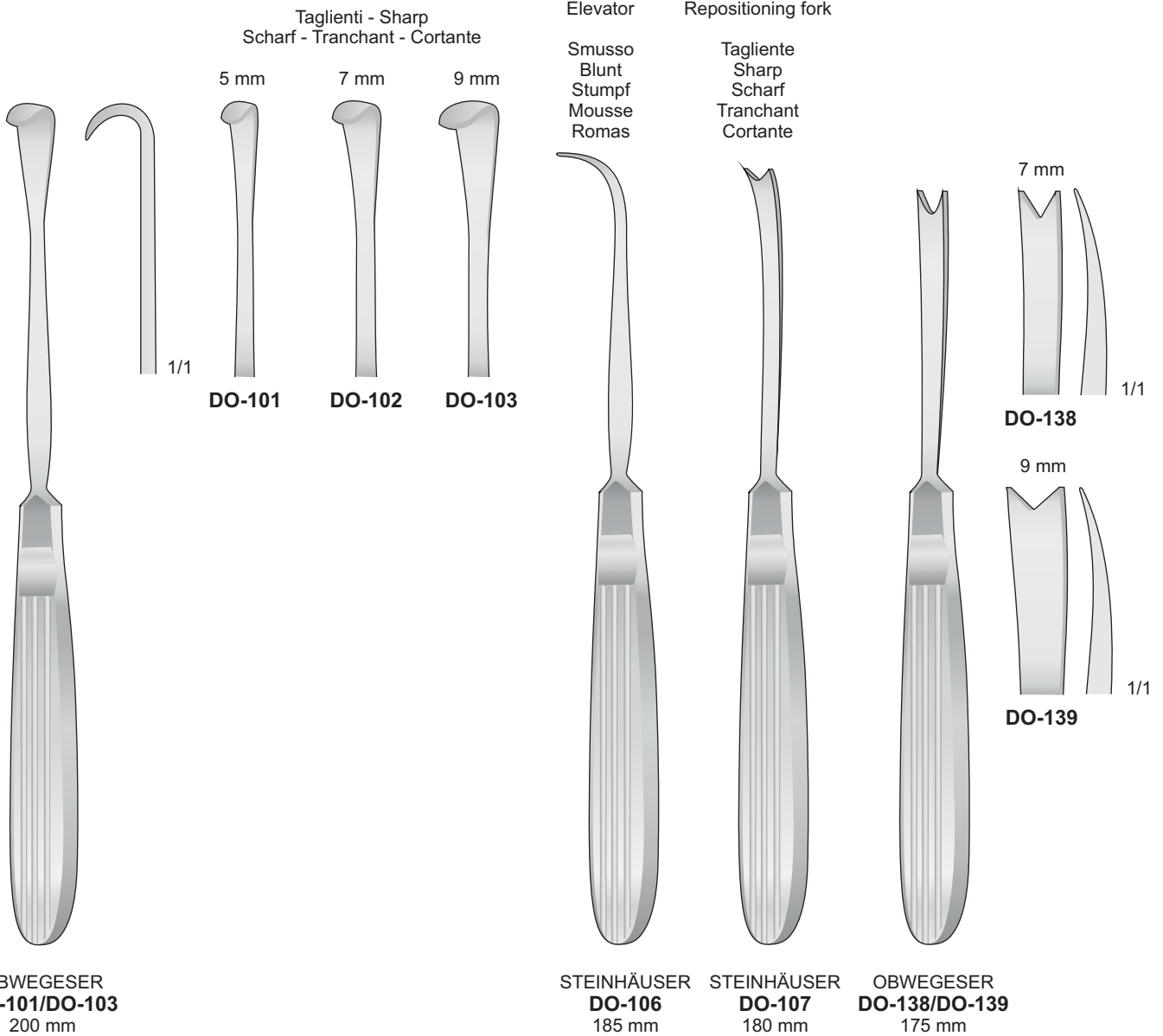


**DO-90**  
200 mm

7 mm

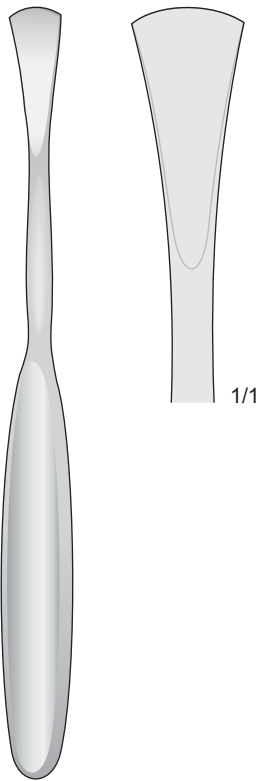


**DO-117**  
200 mm

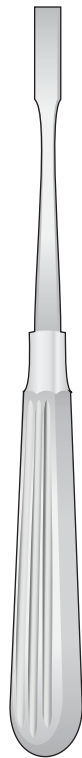




15 mm

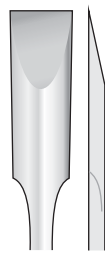


CUSHING  
FK-252  
190 mm



ADSON  
FK-260/FK-263  
170 mm

8 mm



FK-260

7 mm



FK-261

7 mm



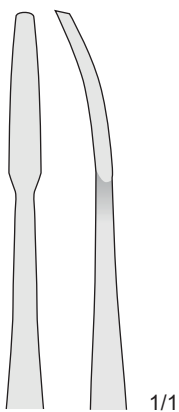
FK-262

7 mm



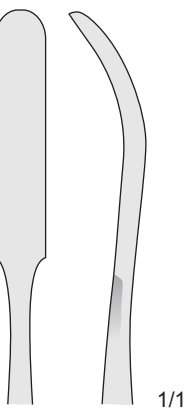
FK-263

2,5 mm



JOSEPH  
FK-80  
170 mm

7 mm



JOSEPH  
FK-82  
180 mm

10 mm



MOLT  
MO-15  
160 mm

10 mm



BT-05

12 mm



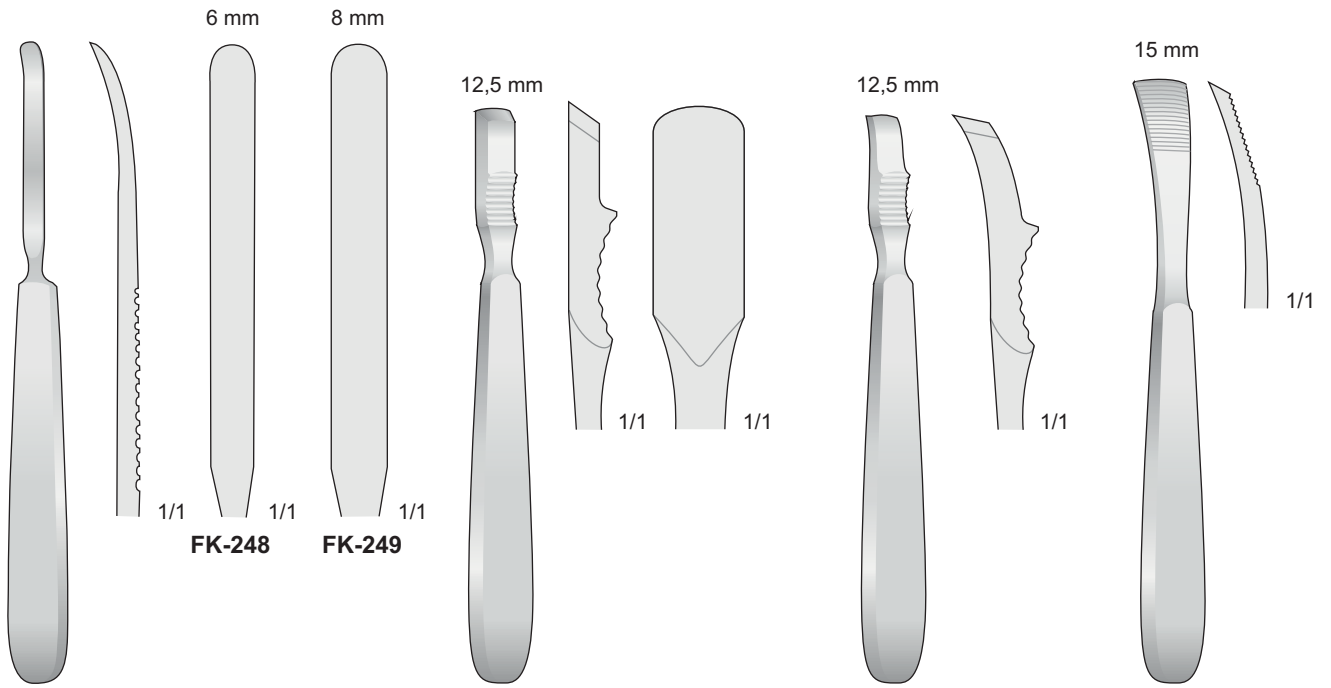
BT-06

15 mm



BT-07

HENAHAN  
BT-05/BT-07  
175 mm

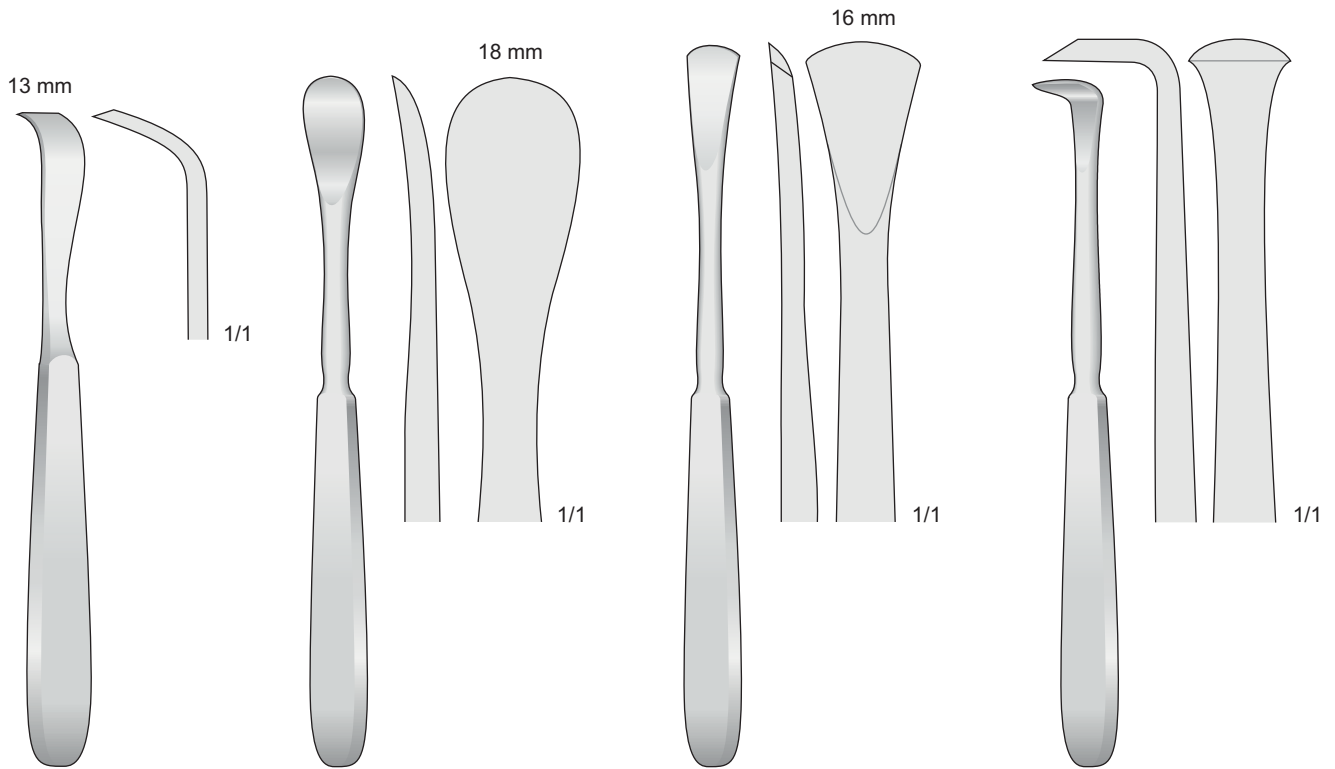


**FK-248/FK-249**  
170 mm

**FARABEU**  
**FK-250**  
150 mm

**FARABEU**  
**FK-251**  
150 mm

**JANSEN**  
**FK-255**  
165 mm



**SCHNEIDER**  
**FK-258**  
175 mm

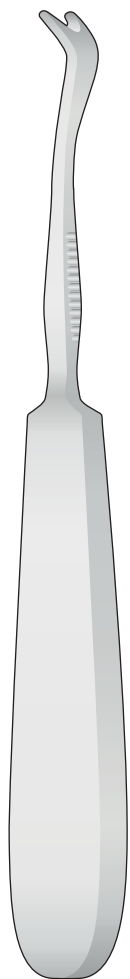
**SEDILLOT**  
**FK-254**  
185 mm

**LANGENBECK**  
**FK-256**  
190 mm

**LANGENBECK**  
**FK-257**  
180 mm

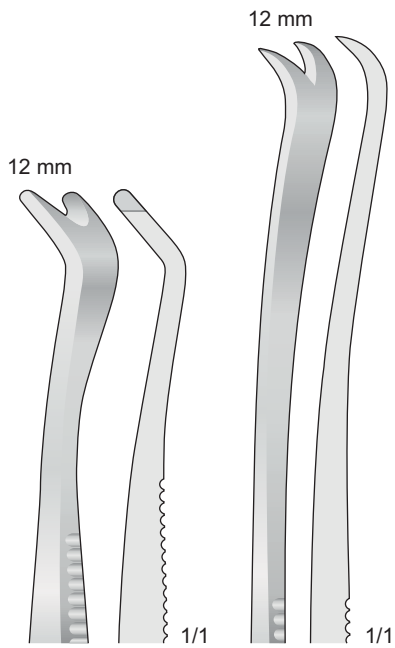


Sinus  
Hipophysectomia



SEMB  
FK-40/FK-44

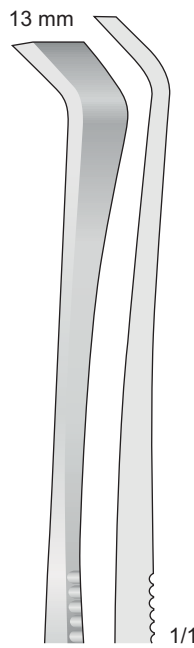
Sinus and  
Hypophysectomy



**FK-40**  
190 mm

**FK-41**  
230 mm

Sinus und  
Hypophysectomie

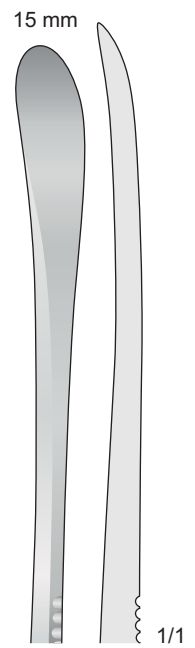


**FK-42**  
230 mm

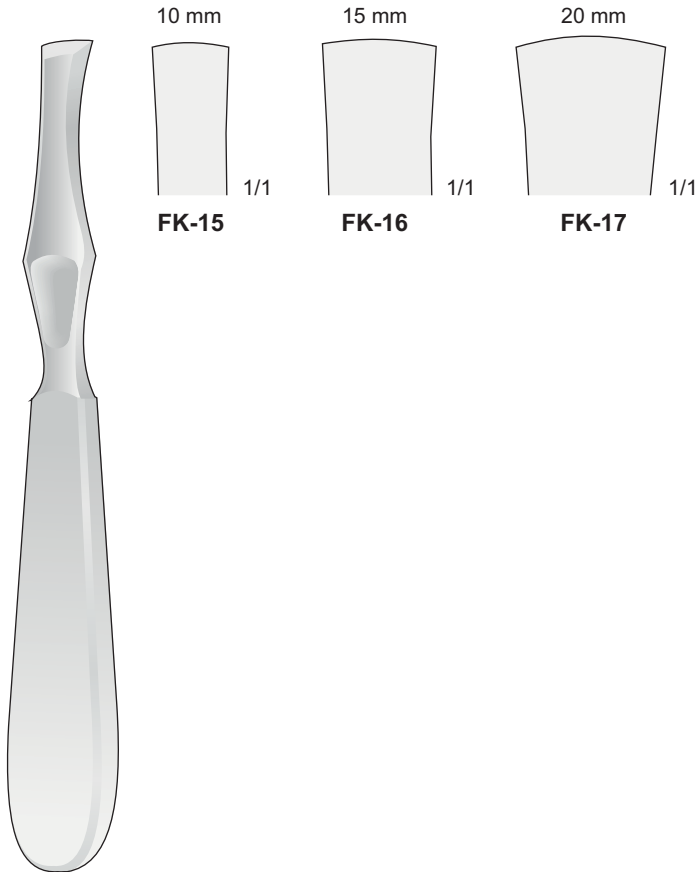


**FK-43**  
230 mm

Elevation e dissezion  
de apofisi zigomatica



**FK-44**  
230 mm



LAMBOTTE  
FK-15/FK-17  
205 mm



DOYEN  
FK-18  
180 mm

DOYEN  
FK-19  
180 mm



Con manico Ferrozell  
With Ferrozell handle  
Mit Ferrozellgriff  
Avec poignée en Ferrozell  
Con mango de Ferrozell



**FK-234**  
180 mm



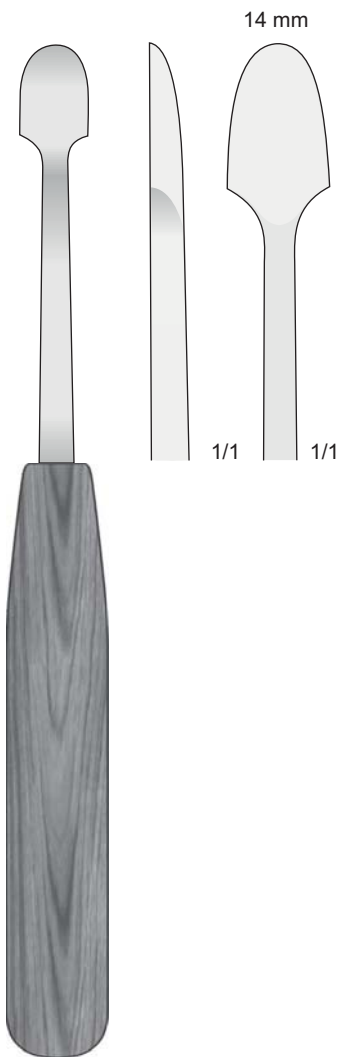
**FK-230**  
190 mm



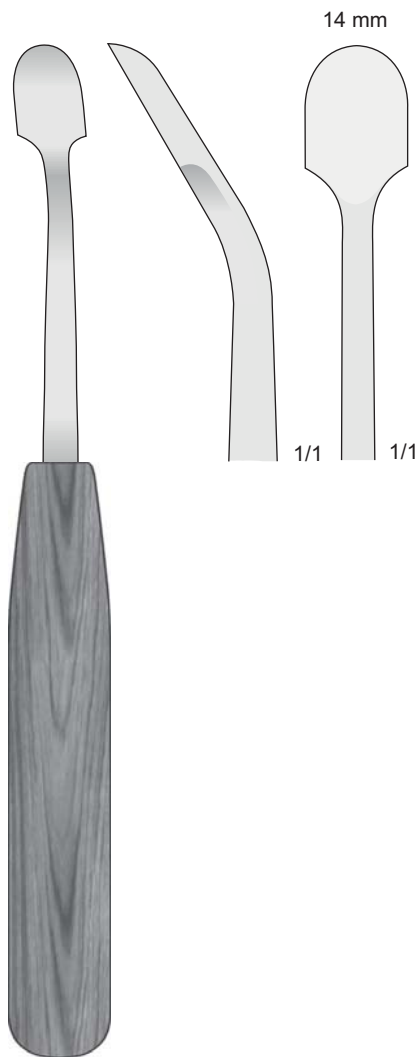
**FK-232**  
190 mm



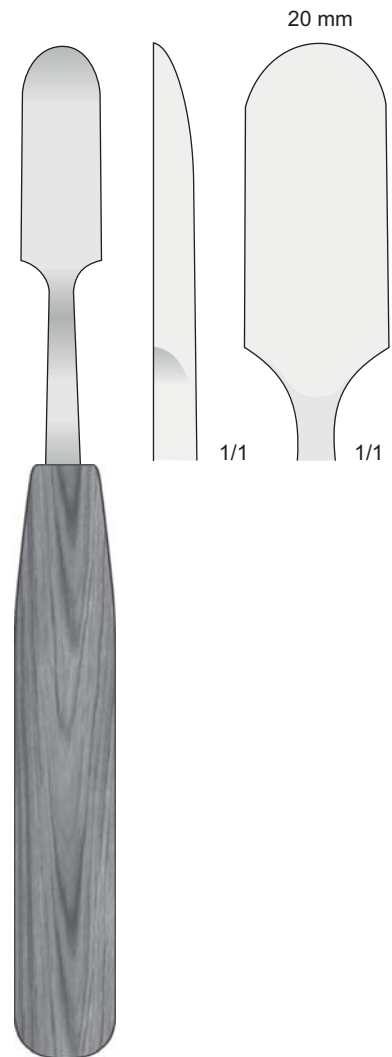
Con manico Ferrozell  
With Ferrozell handle  
Mit Ferrozellgriff  
Avec poignée en Ferrozell  
Con mango de Ferrozell



**FK-236**  
200 mm



**FK-238**  
200 mm



**FK-240**  
200 mm





Con manico Ferrozell  
With Ferrozell handle  
Mit Ferrozellgriff  
Avec poignée en Ferrozell  
Con mango de Ferrozell

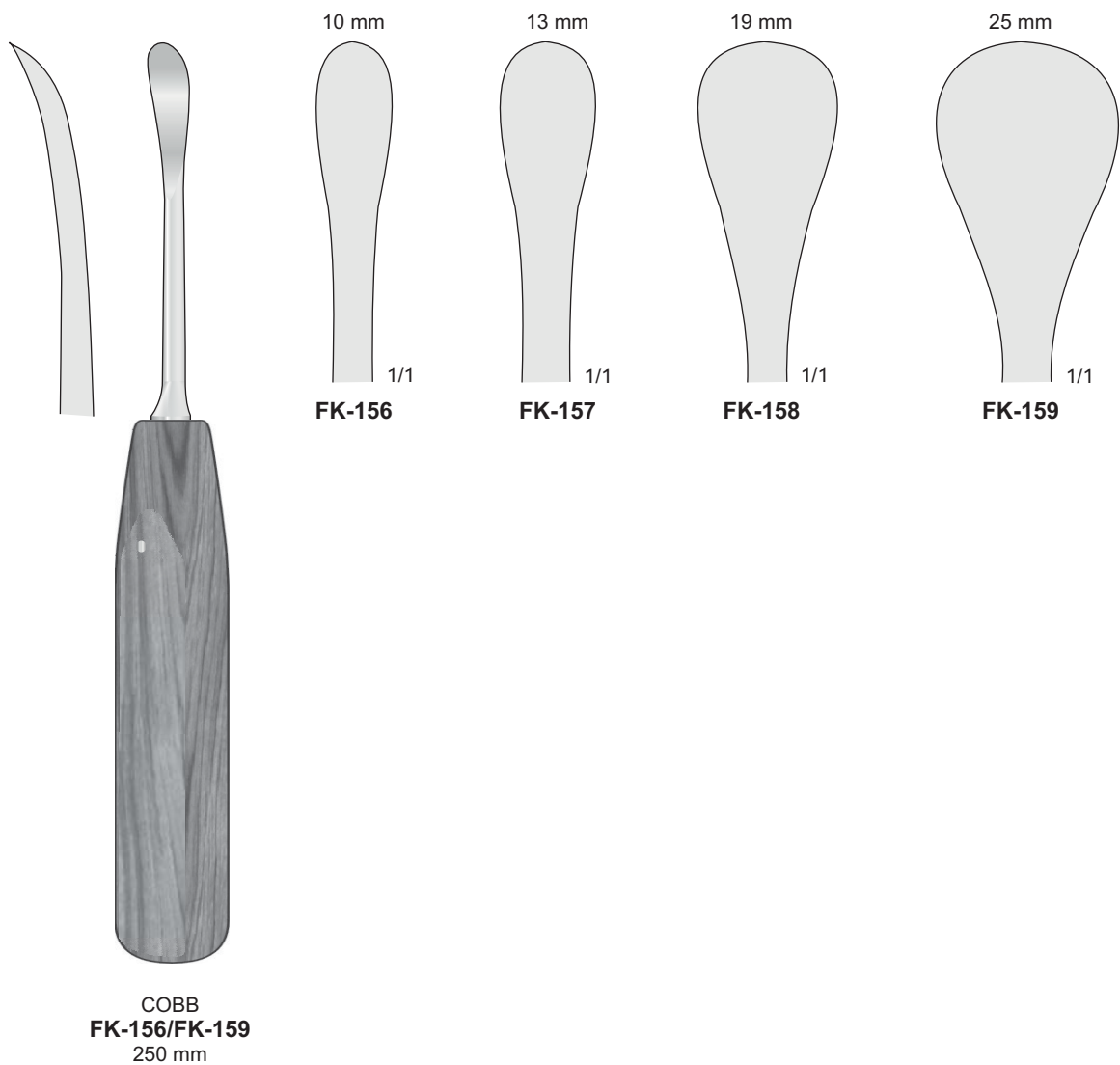
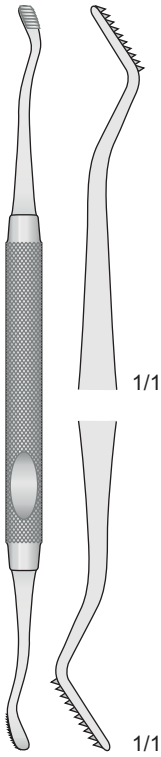


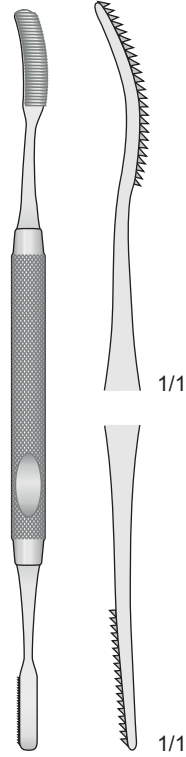


Fig. 67



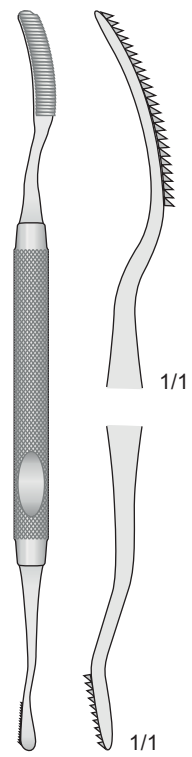
**HOWARD  
DO-1**  
180 mm

Fig. 45

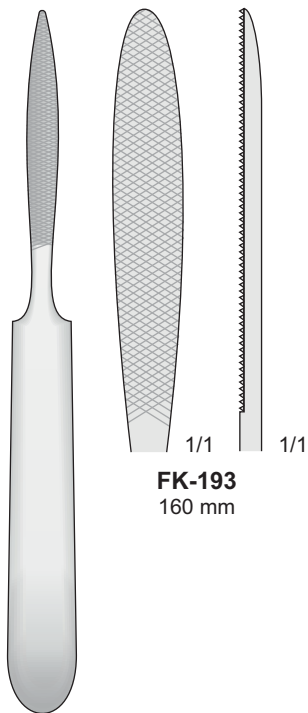


**MILLER  
DO-2**  
185 mm

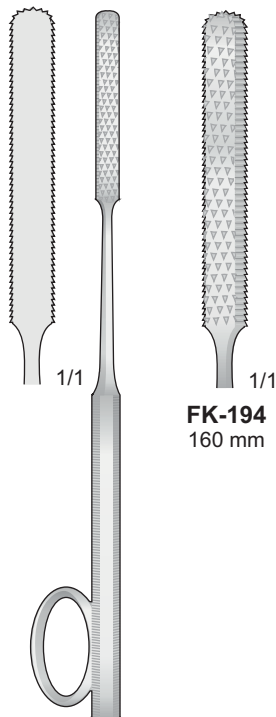
Fig. 52



**MILLER  
DO-3**  
180 mm



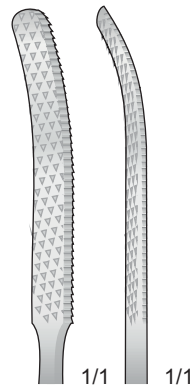
**JOSEPH  
FK-193**  
160 mm



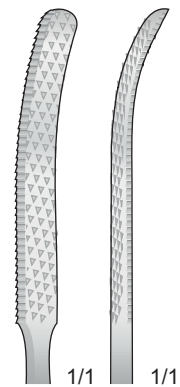
**GALLAHER  
FK-194/FK-196**  
160 mm



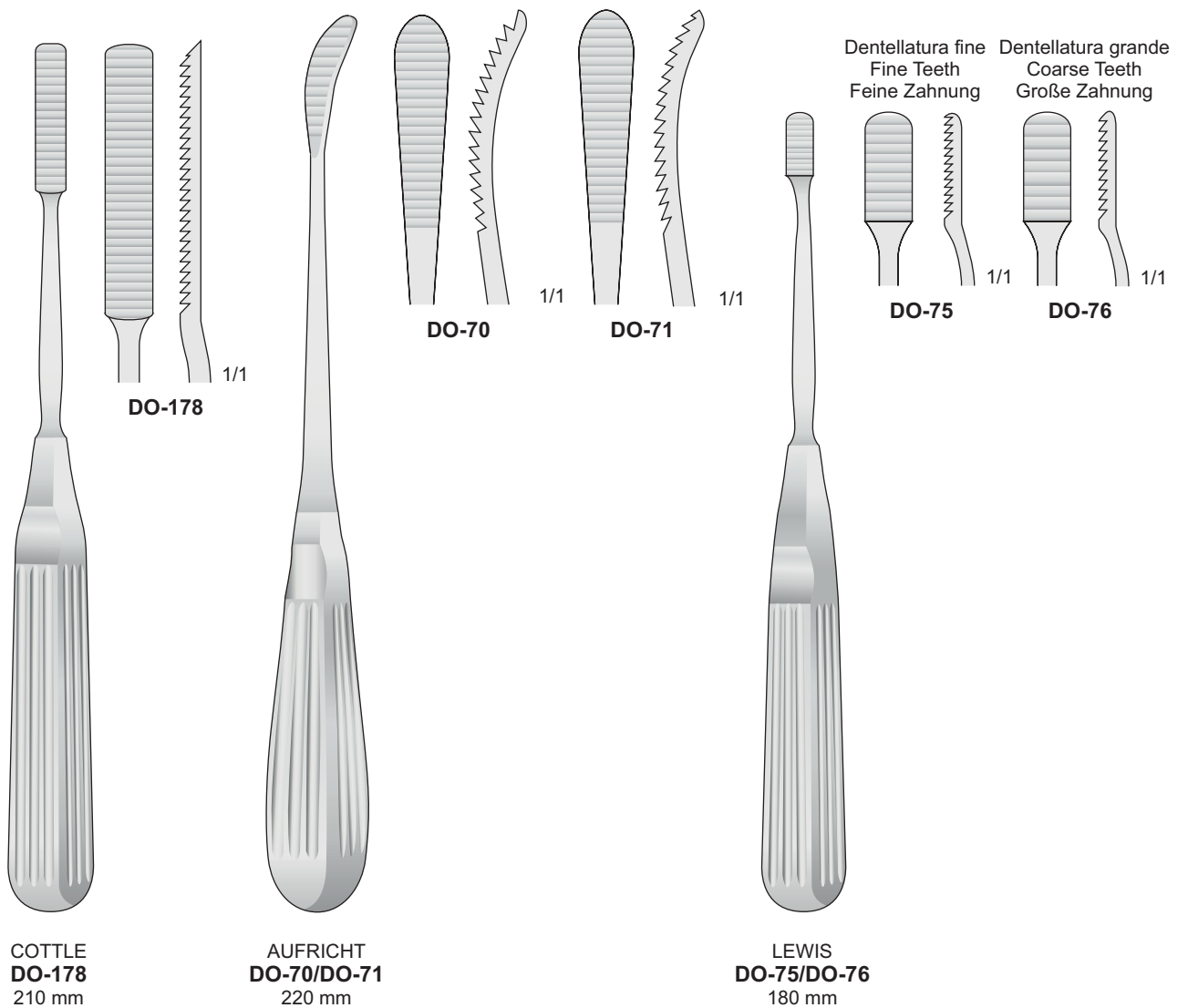
**FK-194**  
160 mm

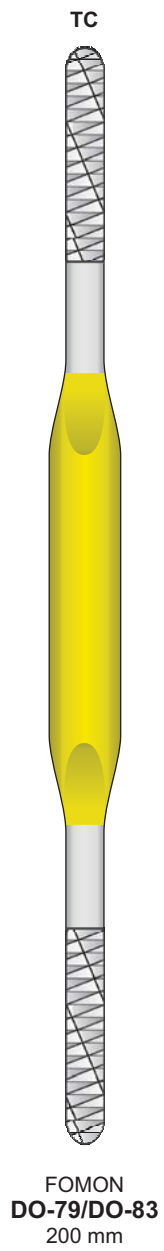


**FK-195**  
160 mm



**FK-196**  
160 mm





1

2



DO-79



3

4



DO-80

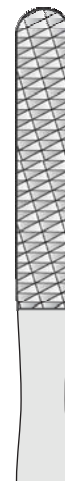


5

6

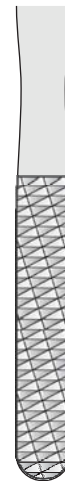


DO-81



7

8

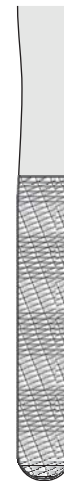


DO-82



9

10



DO-83



8 mm



8 mm

**FK-96**  
210 mm

2 mm



5 mm

**FK-97**  
210 mm



1/1



1/1

8 mm



8 mm

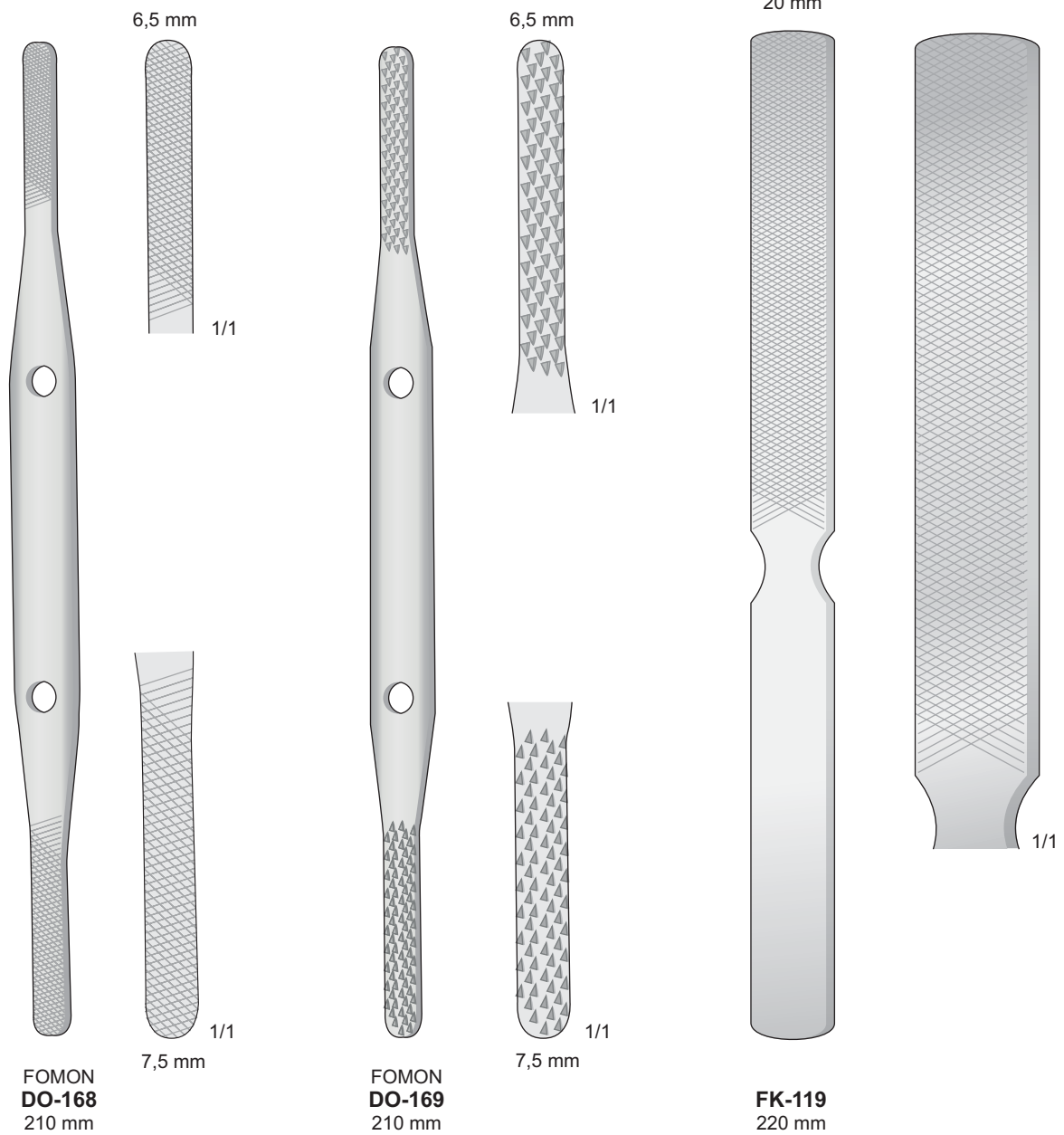
**FK-98**  
210 mm

8 mm



8 mm

**FK-99**  
210 mm





Lime per osso

Bone files

Knochenfeilen

Limes à os

Limas para huesos

20 mm



**FK-85**  
295 mm

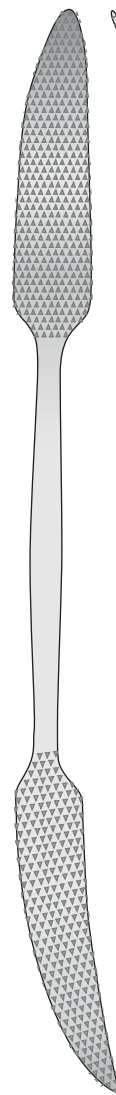
13 mm



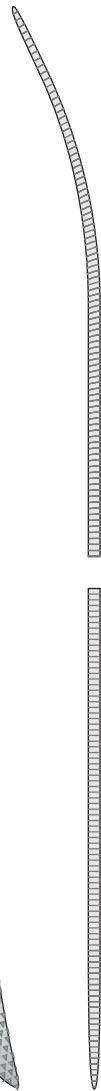
**FK-86**  
240 mm



1/1

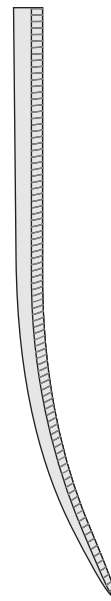


**PUTTI  
FK-94**  
270 mm

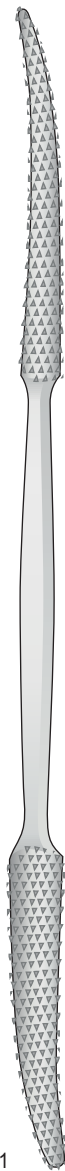


1/1

1/1



1/1



**PUTTI  
FK-95**  
300 mm



1/1



1/1



Lime per osso

Bone files

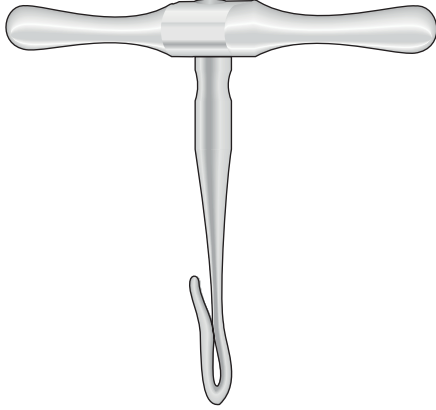
Knochenfeilen

Limes à os

Limas para huesos

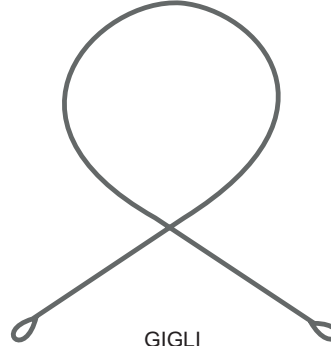
Coppia  
(2 pezzi)

1 paar  
1 pair



GIGLI  
FK-11

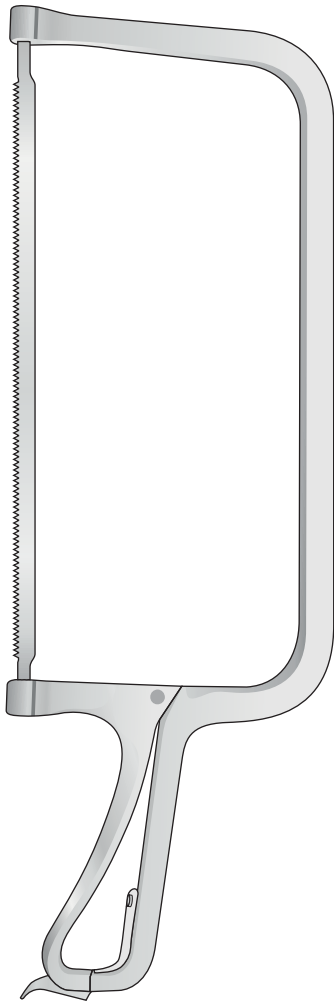
Acciaio  
Rostfrei  
Stainless  
Inox



GIGLI  
FK-13  
300 mm  
FK-14  
500 mm

**LS-300**

Completa con 3 seghe  
Complete with 3 saws  
Komplett mit 3 Sägen  
Complet avec 3 scies  
Completo con 3 sierras



COLLIN  
LS-300  
390 mm

Fig.1

Fig.2

Fig.3



LS-301  
280 mm

LS-302  
280 mm

LS-303  
280 mm



LINDEMANN  
FK-243  
200 mm

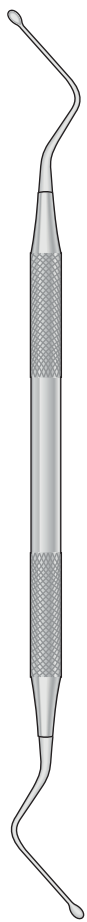


1/1

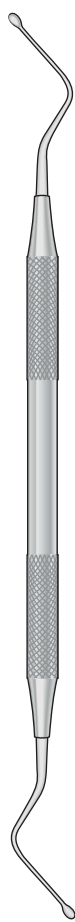


LANGENBECK  
FK-244  
235 mm

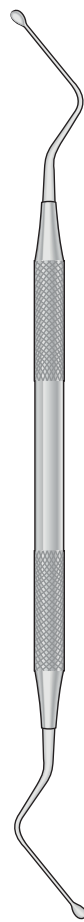




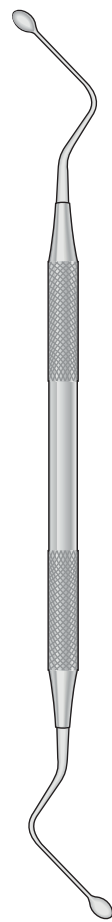
HEMINGWAY  
C-1  
175 mm



HEMINGWAY  
C-2  
175 mm

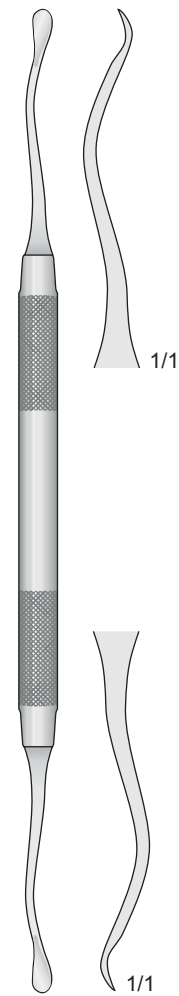


HEMINGWAY  
C-3  
175 mm



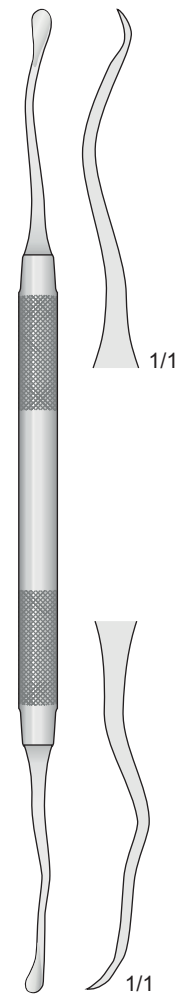
HEMINGWAY  
C-4  
175 mm

Fig. 1



SL-1  
200 mm

Fig. 2



SL-2  
195 mm



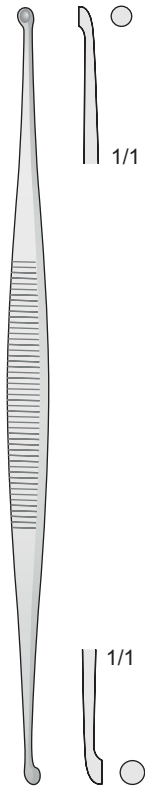
Curette, Cucchiai taglienti

Sharp curettes

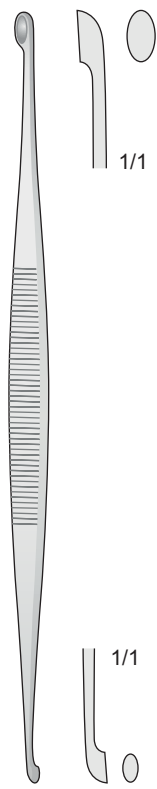
Scharfe Löffel

Curettes tranchantes

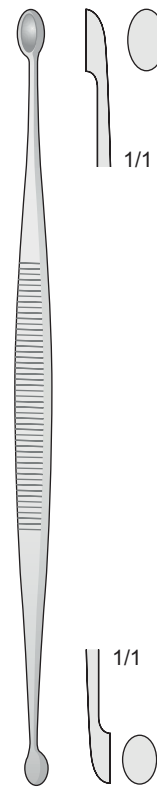
Cucharillas cortantes



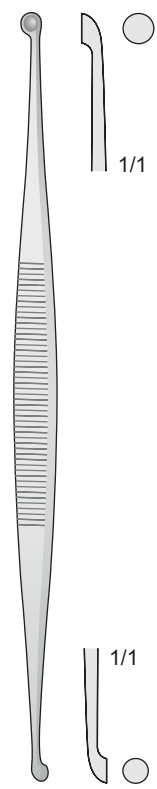
MARTINI  
FK-70  
140 mm



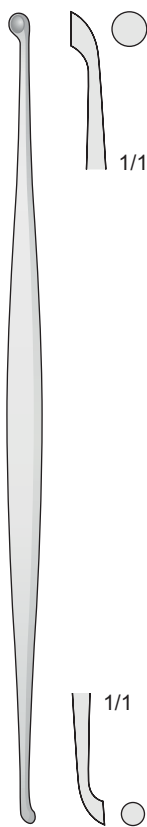
WILLIGER  
FK-71  
145 mm



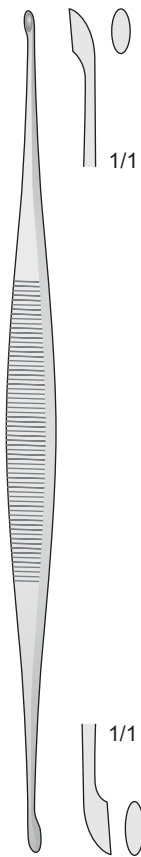
JACOBSON  
FK-75  
140 mm



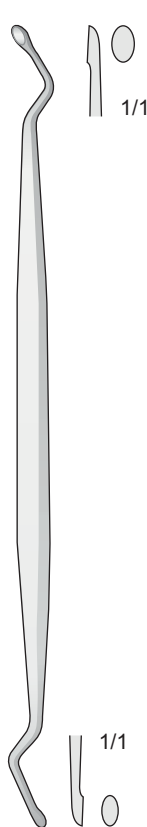
MARTINI  
FK-76  
140 mm



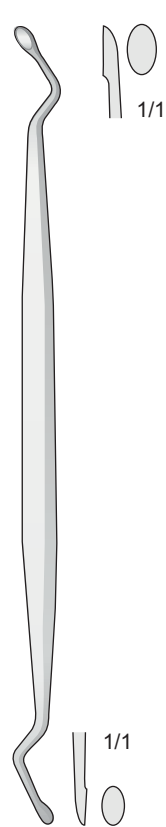
JANZEN  
FK-77  
160 mm



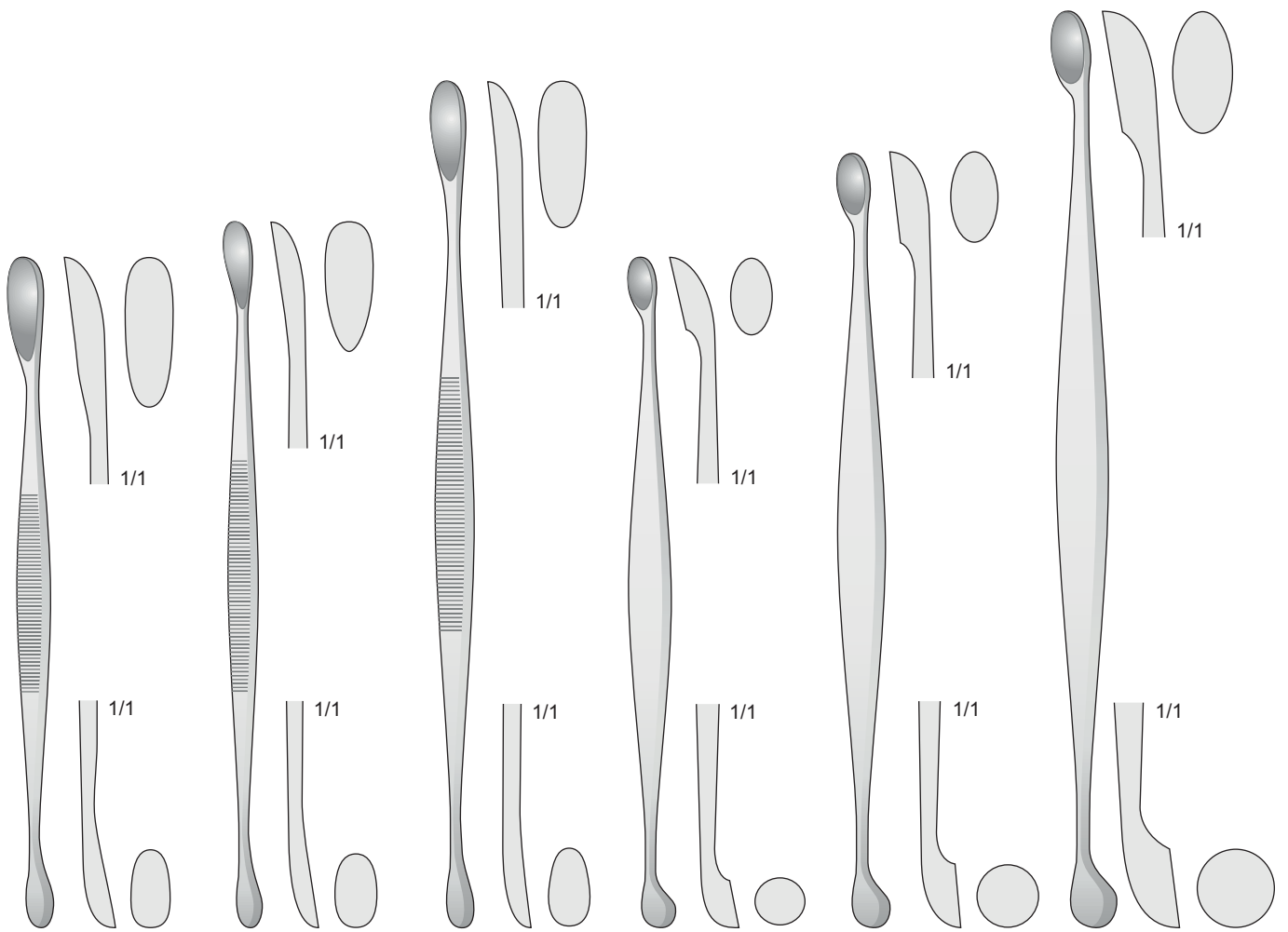
BARTH  
FK-78  
180 mm



FK-83  
160 mm



JANZEN  
FK-84  
160 mm



**VOLKMANN  
FK-79**  
130 mm

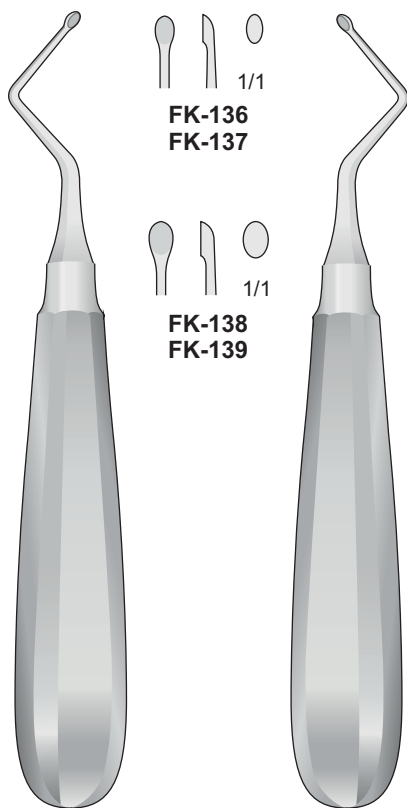
**VOLKMANN  
FK-72**  
145 mm

**VOLKMANN  
FK-73**  
170 mm

**FK-177**  
130 mm

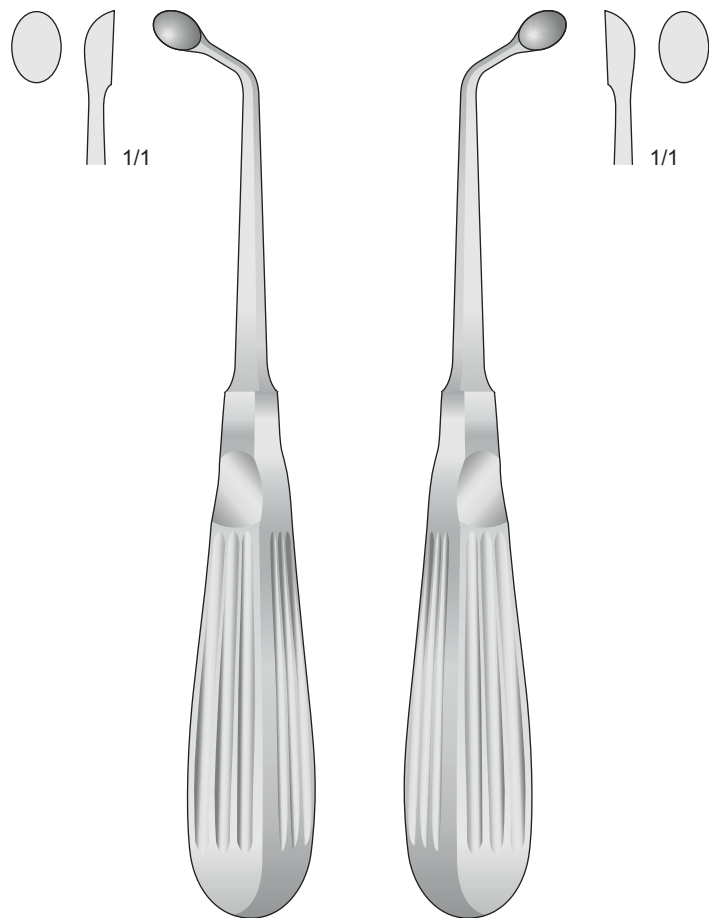
**FK-74**  
160 mm

**FK-178**  
200 mm



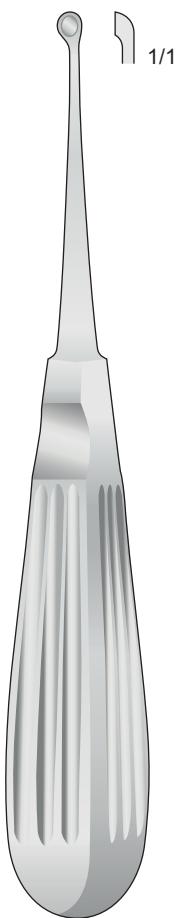
KERPEL  
FK-136  
FK-138  
145 mm

KERPEL  
FK-137  
FK-139  
145 mm



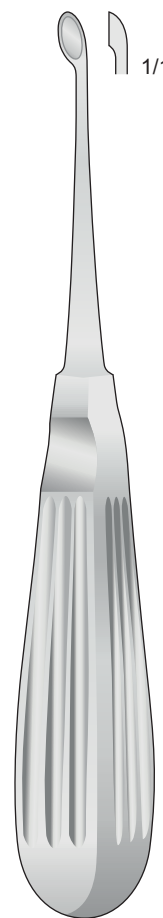
UFFENDORDE  
FK-188  
170 mm

UFFENDORDE  
FK-189  
170 mm



BRUNS  
FK-110/FK-116  
165 mm

- |                 |                |               |
|-----------------|----------------|---------------|
| Fig.000<br>3 mm | Fig.00<br>4 mm | Fig.0<br>5 mm |
|                 |                |               |
| <b>FK-110</b>   | <b>FK-111</b>  | <b>FK-112</b> |
| Fig.1<br>6 mm   | Fig.2<br>8 mm  |               |
|                 |                |               |
| <b>FK-113</b>   | <b>FK-114</b>  |               |
| Fig.3<br>10 mm  | Fig.4<br>12 mm |               |
|                 |                |               |
| <b>FK-115</b>   | <b>FK-116</b>  |               |



SCHEDE  
FK-120/FK-126  
170 mm

- |                   |                  |                 |
|-------------------|------------------|-----------------|
| Fig.000<br>2,5 mm | Fig.00<br>3,4 mm | Fig.0<br>4,2 mm |
|                   |                  |                 |
| <b>FK-120</b>     | <b>FK-121</b>    | <b>FK-122</b>   |
| Fig.1<br>5,2 mm   | Fig.2<br>6,3 mm  |                 |
|                   |                  |                 |
| <b>FK-123</b>     | <b>FK-124</b>    |                 |
| Fig.3<br>7,4 mm   | Fig.4<br>8 mm    |                 |
|                   |                  |                 |
| <b>FK-125</b>     | <b>FK-126</b>    |                 |



Curette, Cucchiali taglienti

Sharp curettes

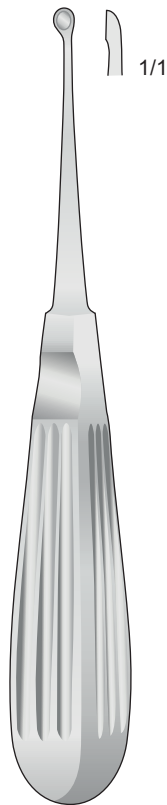
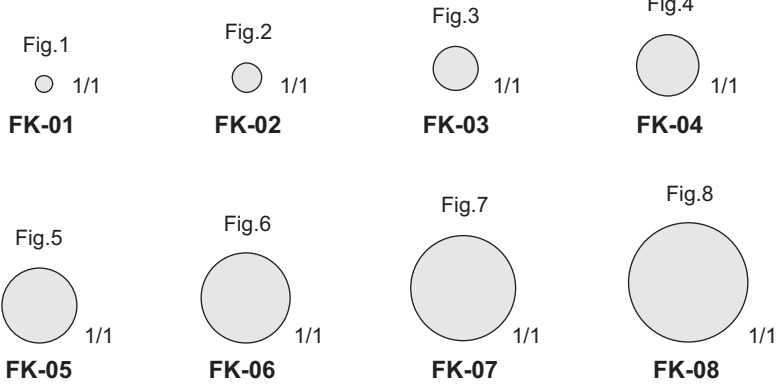
Scharfe Löffel

Curettes tranchantes

Cucharillas cortantes



**FK-01/FK-08**  
180 mm



**VOLKMANN**  
**FK-60/FK-69**  
170 mm

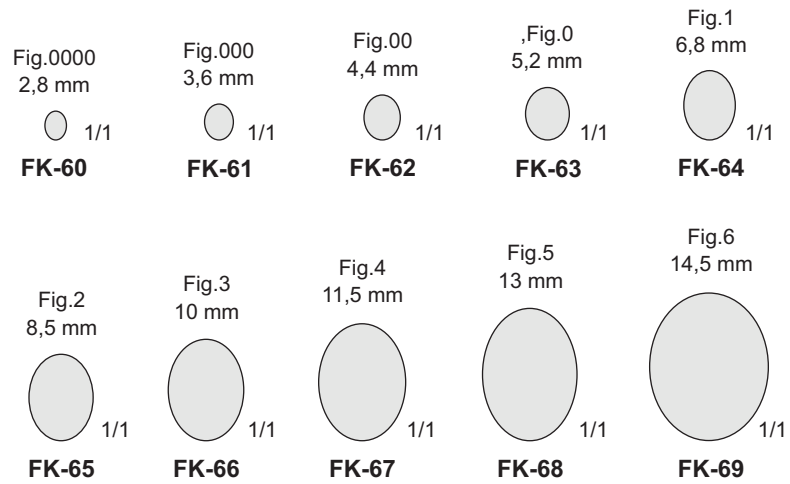




Fig.1  
1/1  
**FK-31**

Fig.2  
1/1  
**FK-32**

Fig.3  
1/1  
**FK-33**

Fig.4  
1/1  
**FK-34**

Fig.5  
1/1  
**FK-35**

Fig.6  
1/1  
**FK-36**

Fig.7  
1/1  
**FK-37**

Fig.8  
1/1  
**FK-38**

Fig.9  
1/1  
**FK-39**

**FK-31/FK-39**  
210 mm

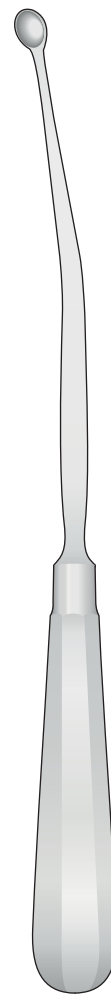


Fig. 1  
1/1  
**FK-21**

Fig. 2  
1/1  
**FK-22**

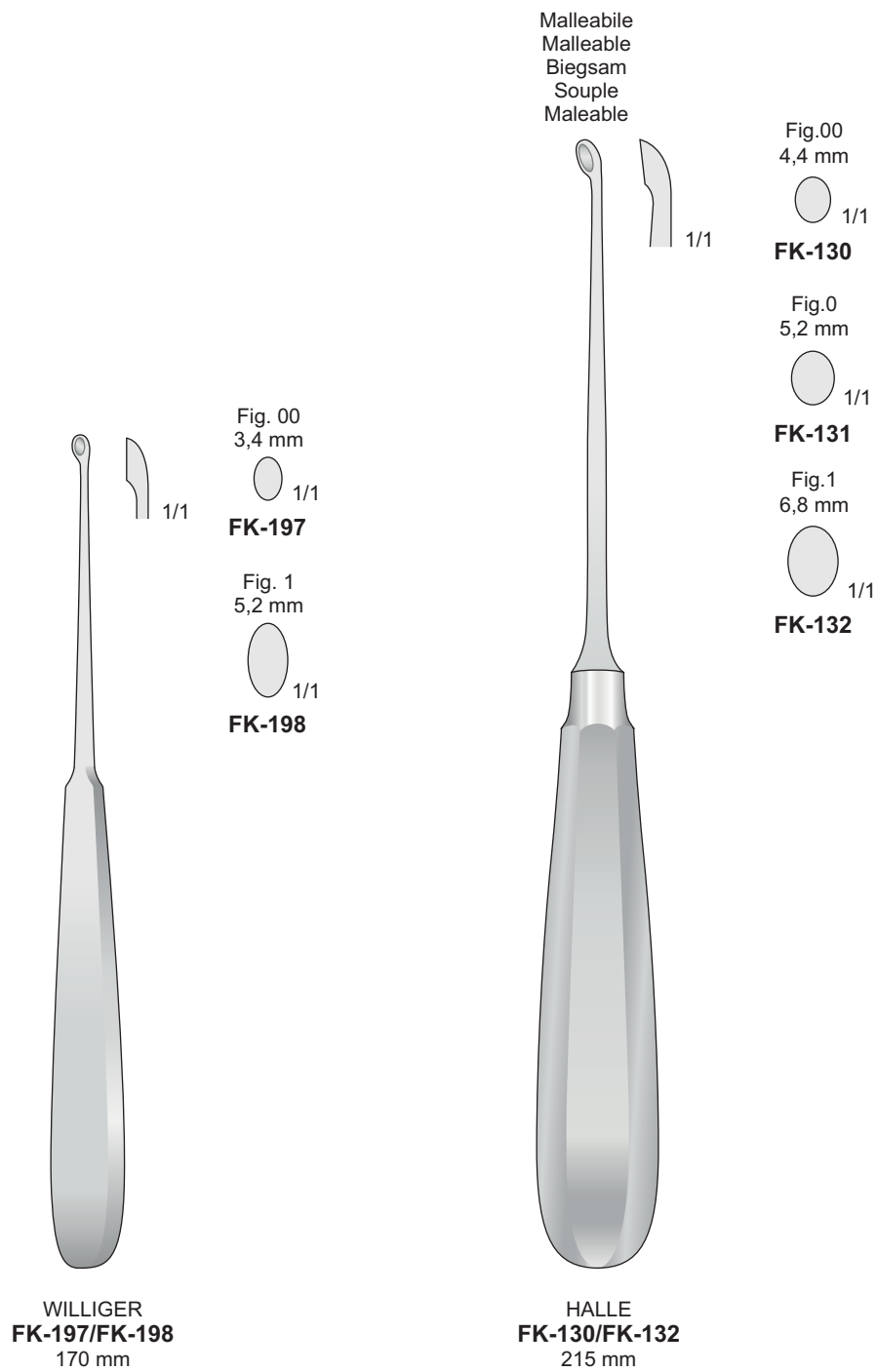
Fig. 3  
1/1  
**FK-23**

Fig. 4  
1/1  
**FK-24**

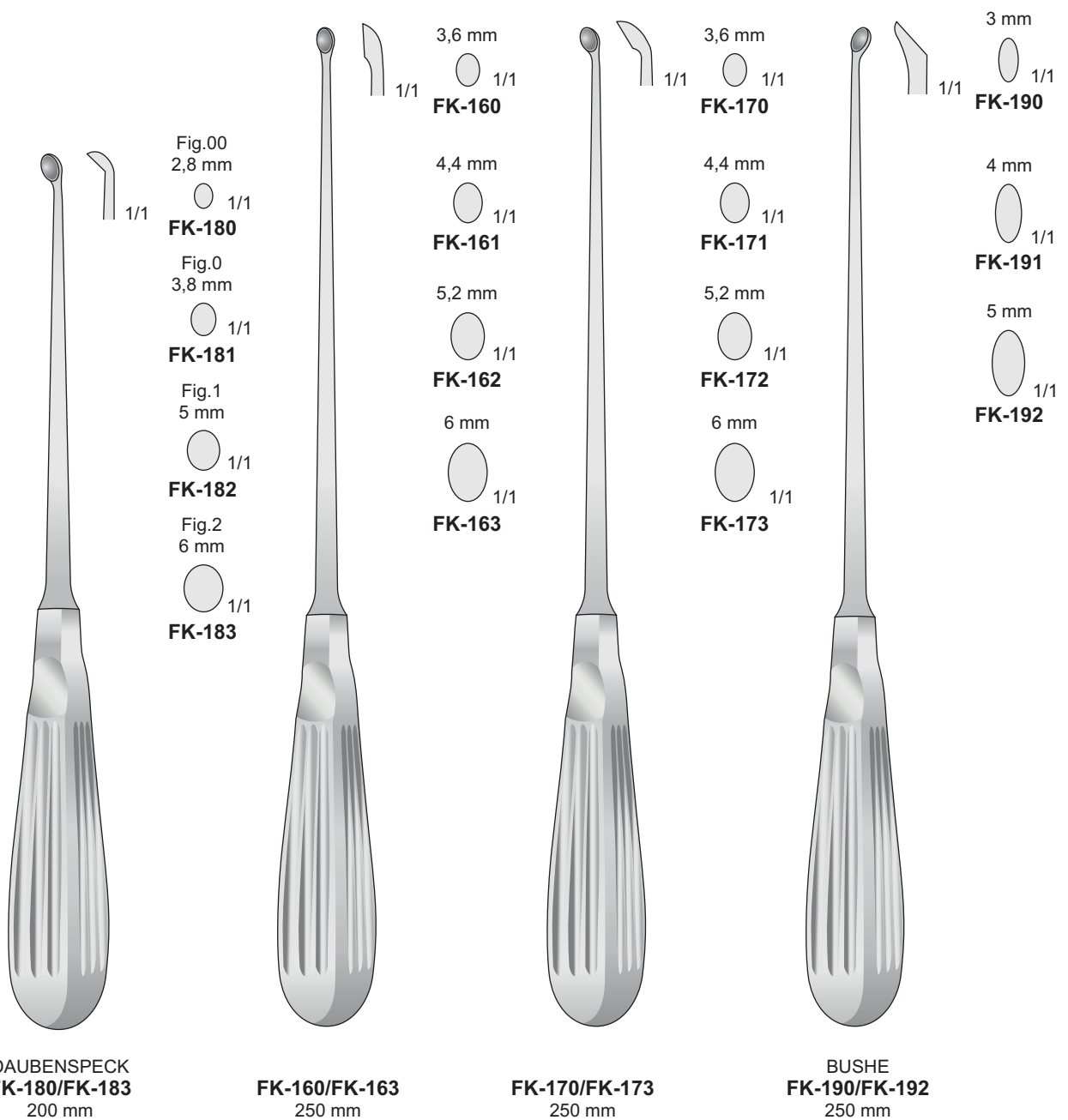
Fig. 5  
1/1  
**FK-25**

Fig. 6  
1/1  
**FK-26**

**FK-21/FK-26**  
260 mm









SIMON  
FK-147/FK-149  
235 mm

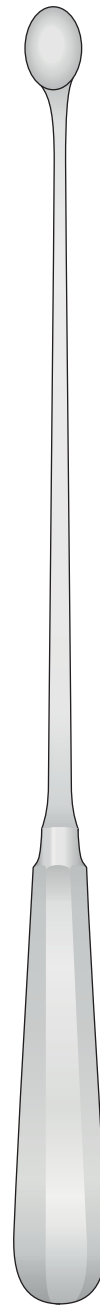
- Fig.000  
3,6 mm  
1/1  
**FK-147**
- Fig.00  
4,4 mm  
1/1  
**FK-148**
- Fig.0  
5,2 mm  
1/1  
**FK-149**



SIMON  
FK-140/FK-145  
240 mm

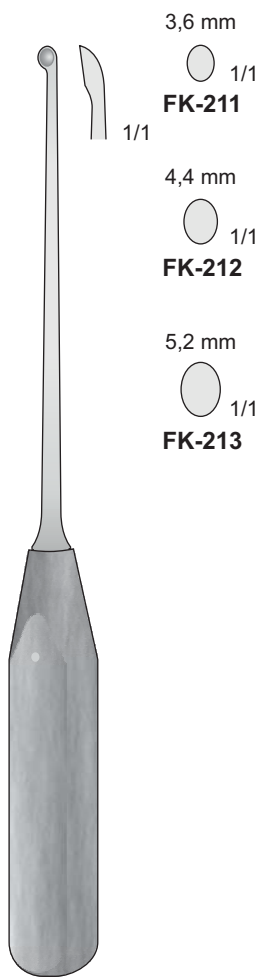
- Fig.1  
6,8 mm  
1/1  
**FK-140**
- Fig.3  
10 mm  
1/1  
**FK-142**
- Fig.5  
13 mm  
1/1  
**FK-144**

- Fig.2  
8,5 mm  
1/1  
**FK-141**
- Fig.4  
11,5 mm  
1/1  
**FK-143**
- Fig.6  
14,5 mm  
1/1  
**FK-145**

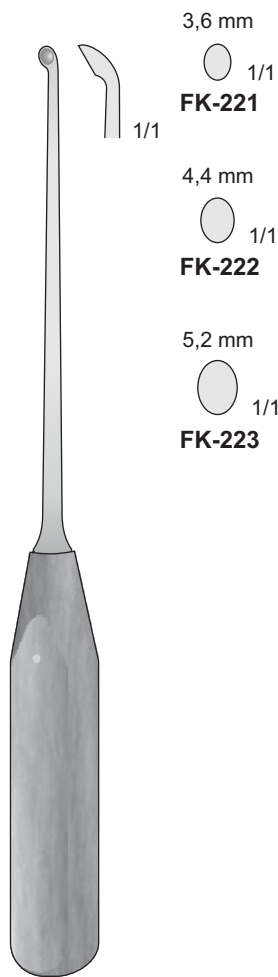


SCHRÖDER  
FK-150/FK-155  
310 mm

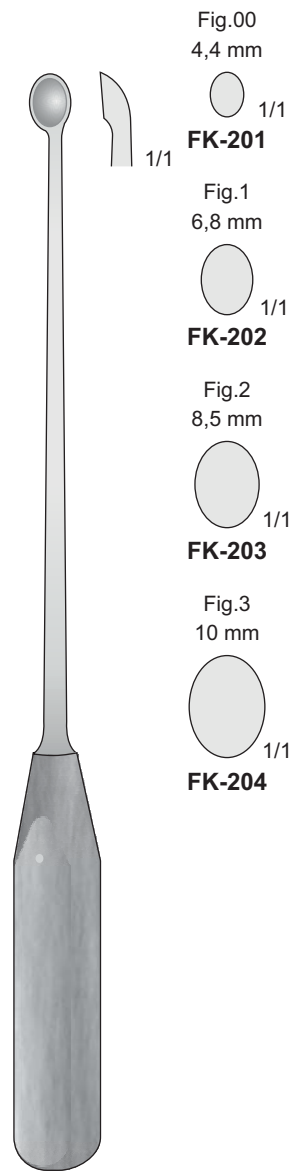
- Fig.1  
6,8 mm  
1/1  
**FK-150**
- Fig.3  
10 mm  
1/1  
**FK-152**
- Fig.5  
13 mm  
1/1  
**FK-154**
- Fig.2  
8,5 mm  
1/1  
**FK-151**
- Fig.4  
11,5 mm  
1/1  
**FK-153**
- Fig.6  
14,5 mm  
1/1  
**FK-155**



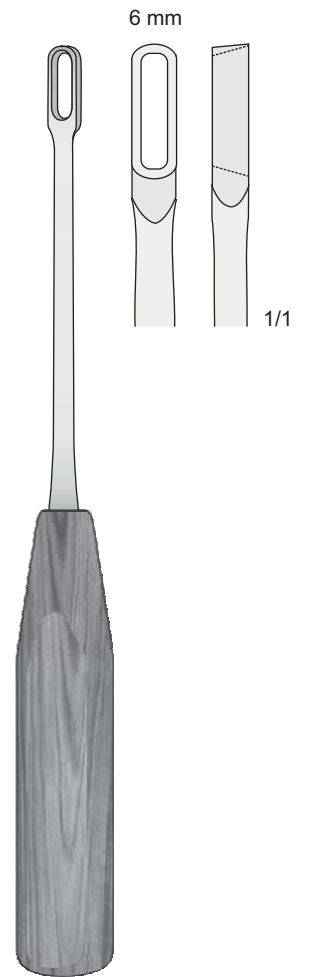
CASPAR  
FK-211/FK-213  
220 mm



CASPAR  
FK-221/FK-223  
220 mm



FK-201/FK-204  
270 mm

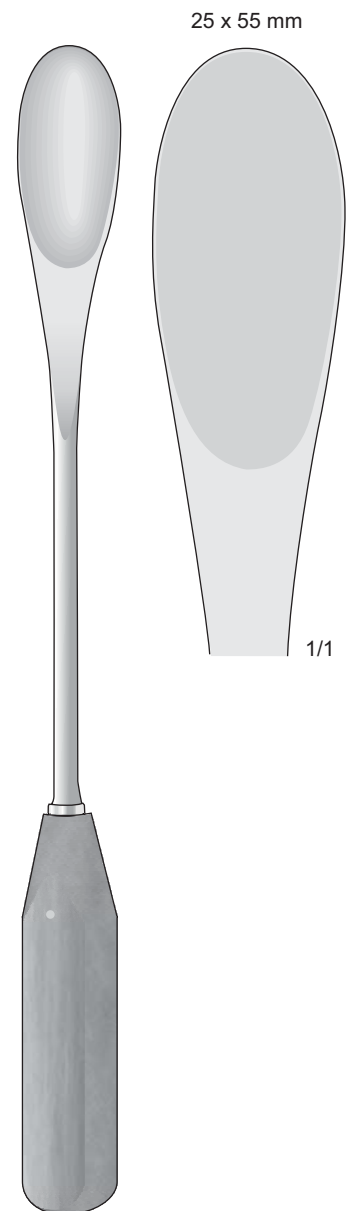
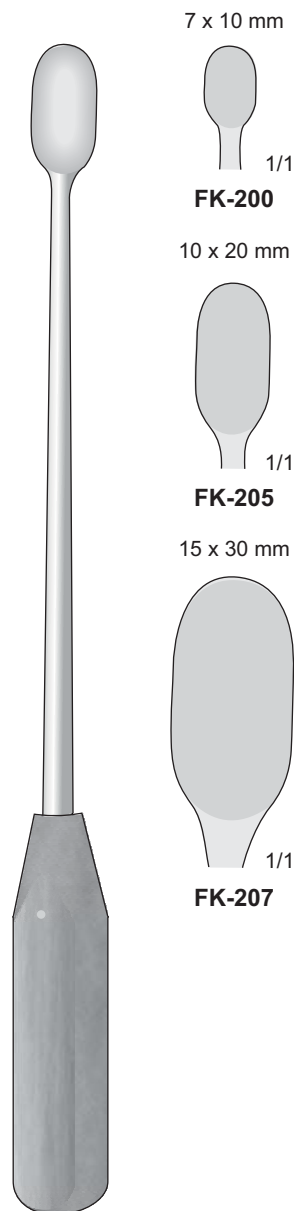
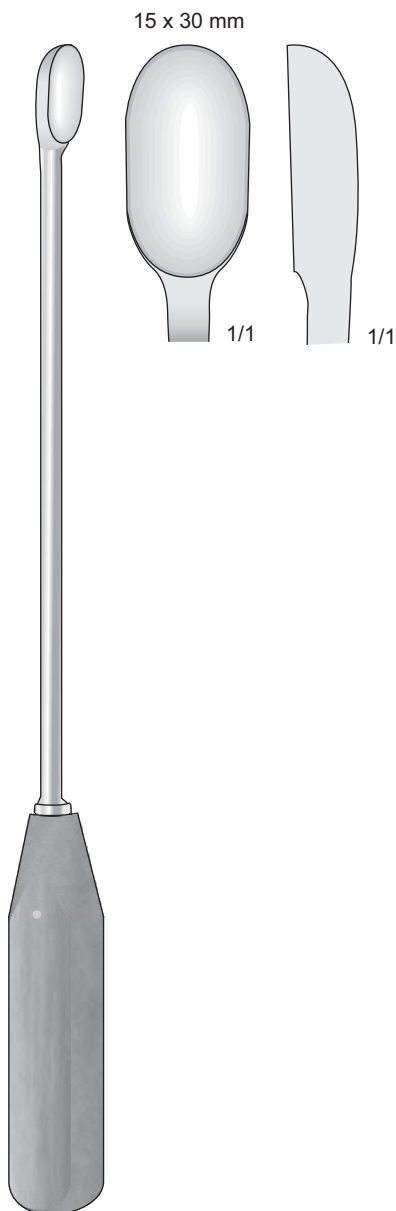


TESSIER  
FL-198  
220 mm



Strumentario per protesi femorale  
Femoral prosthesis instrumentation  
Instruments pour prothese femorale

Con manico Ferrozell  
With Ferrozell handle  
Mit Ferrozellgriff  
Avec poignée en Ferrozell  
Con mango de Ferrozell





12

Martelli, Scalpelli  
Hammers, Bone chisels  
Hämmer, Knochenmeißel  
Maillets, Scalpel  
Martillos, Cinceles





Martelli chirurgici

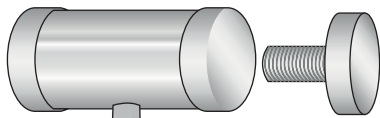
Surgical mallets

Chirurgische Hämmer

Maillets chirurgicaux

Martillos quirurgicos

Ø 25 mm - 200 g

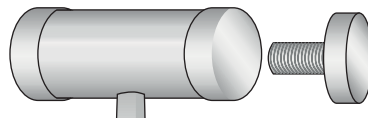


**FL-11R**

Coppia di teste di ricambio  
Pair of spare faces  
Paar Ersatzbacken  
Paire de faces de rechange  
Pareja de tapas intercambiables

MEAD  
**FL-11**  
200 mm

Ø 20 mm - 160 g

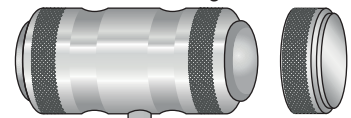


**FL-09R**

Coppia di teste di ricambio  
Pair of spare faces  
Paar Ersatzbacken  
Paire de faces de rechange  
Pareja de tapas intercambiables

MEAD  
**FL-09**  
190 mm

Ø 26 mm - 320 g

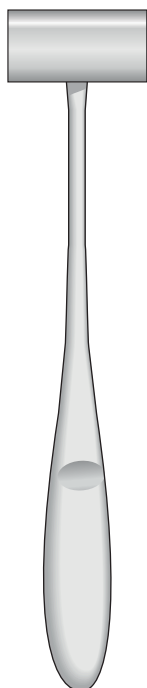


**FL-12R**

Coppia di teste di ricambio  
Pair of spare faces  
Paar Ersatzbacken  
Paire de faces de rechange  
Pareja de tapas intercambiables

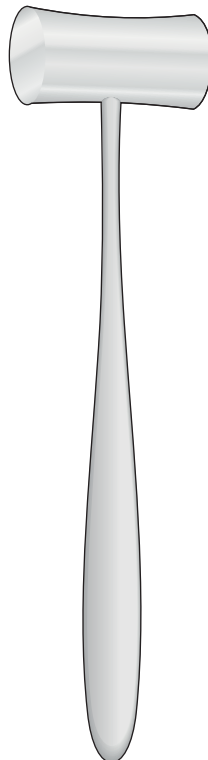
MEAD  
**FL-12**  
190 mm

Ø 20 mm - 140 g



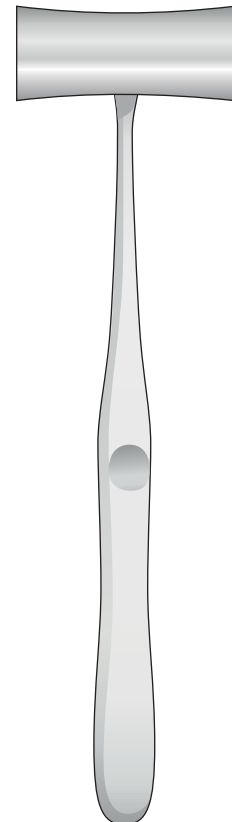
**FL-01**  
165 mm

Ø 25 mm - 300 g



LUCAE  
**FL-10M**  
190 mm

Ø 20 mm - 240 g

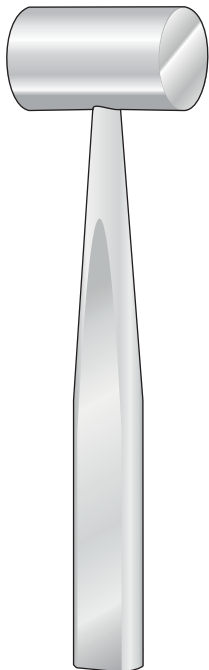


WILLIGER  
**FL-02**  
240 mm



1 Lato piatto - 1 Lato convesso  
1 Side flat - 1 Side convex  
1 Seite flach - 1 Seite convex  
1 Face plate - 1 Face convexe  
1 Parte plana - 1 Parte convexa

Ø 30 mm - 240 g



**COTTLE**  
**FL-104**  
185 mm

Ø 30 mm - 300 g



**BERGMANN**  
**FL-105**  
235 mm

Ø 45 mm - 300 g



**BERGMANN**  
**FL-106**  
245 mm





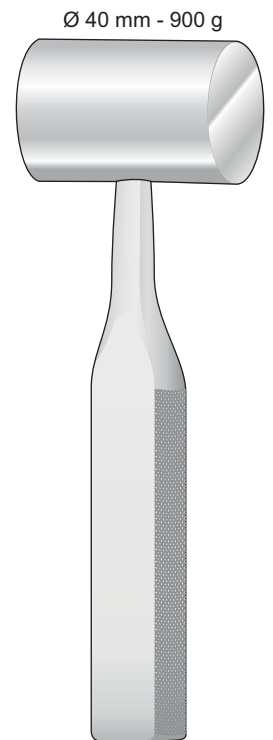
**FL-107**  
240 mm



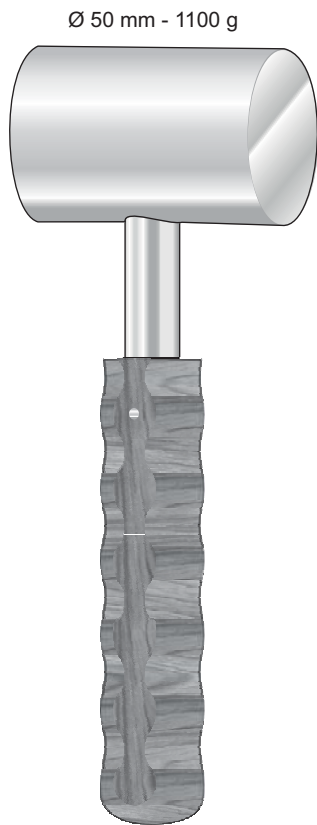
**OMBREDANNE**  
**FL-108**  
240 mm



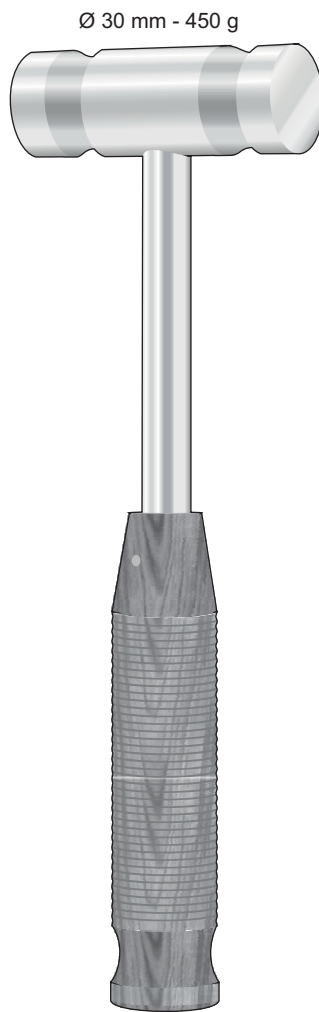
**HEATH**  
**FL-109**  
185 mm



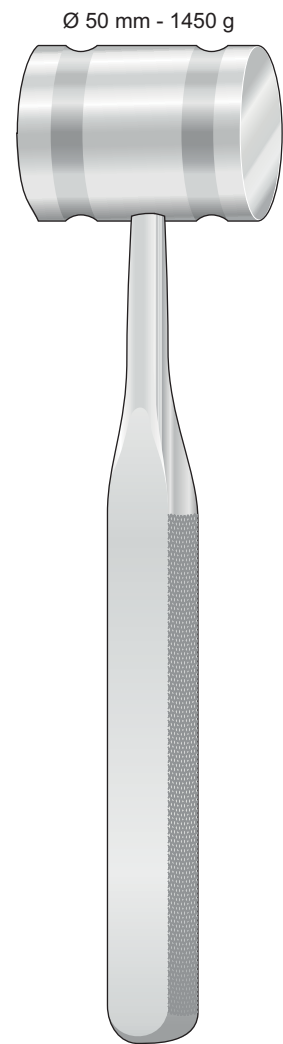
**FL-112**  
190 mm



**FL-111**  
200 mm



**FL-06**  
260 mm




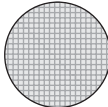
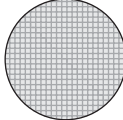
**FL-113**  
270 mm



-  **FF-147**  
Ø3 mm
-  **FF-148**  
Ø5 mm
-  **FF-149**  
Ø8 mm





CASPAR  
FF-147/FF-149  
200 mm



-  **FL-253**  
Ø12 mm
-  **FL-254**  
Ø14 mm
-  **FL-255**  
Ø16 mm

FL-253/FL-255  
200 mm



-  **FL-256**  
3x8 mm
-  **FL-257**  
4x10 mm
-  **FL-258**  
5x15 mm
-  **FL-259**  
6x20 mm

SYPERT  
FL-256/FL-259  
290 mm



Battitori - Osteotomi

Tampers - Osteotomes

Stosser - Osteotome

Pilons - Ostéotomes

Batidor - Osteòtoms

Ø 3 mm

Ø 5 mm

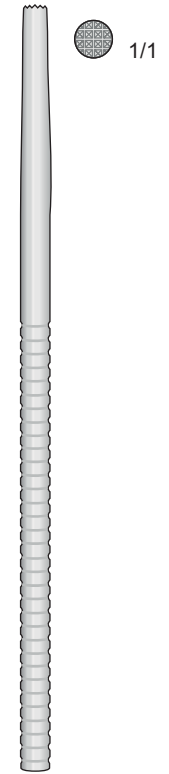
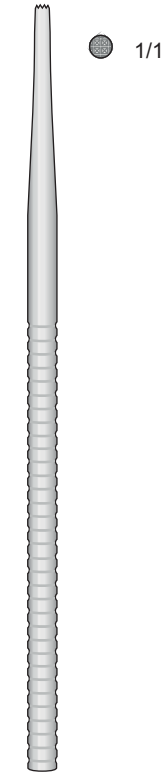
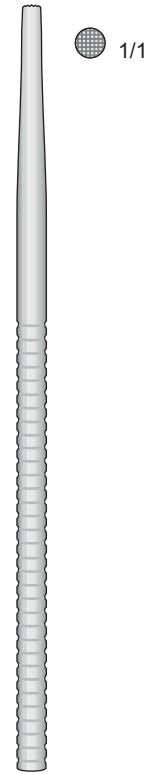
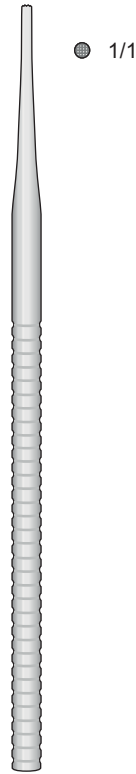
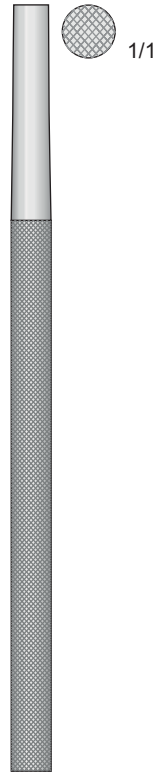
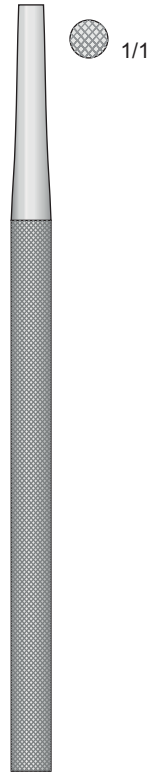
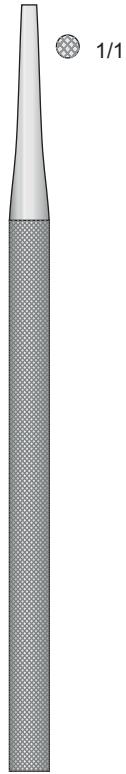
Ø 7 mm

Ø 2 mm

Ø 4 mm

Ø 3 mm

Ø 5 mm



**FL-20**  
155 mm

**FL-21**  
155 mm

**FL-22**  
155 mm

**FL-30**  
155 mm

**FL-31**  
155 mm

**FL-33**  
155 mm

**FL-35**  
155 mm

2 mm

4 mm

6 mm

2 mm

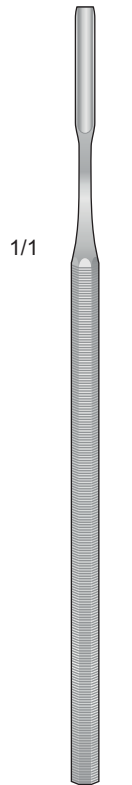
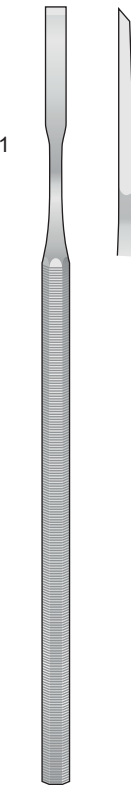
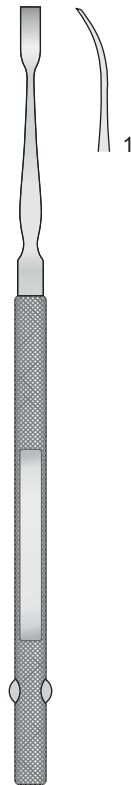
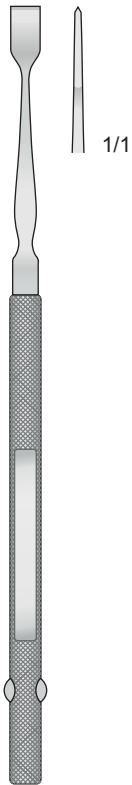
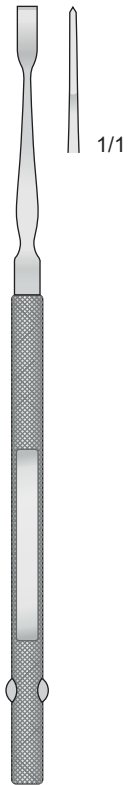
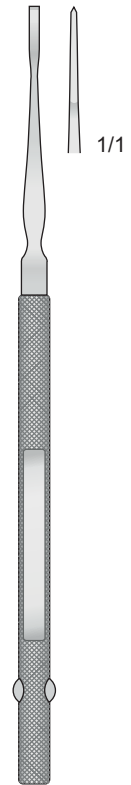
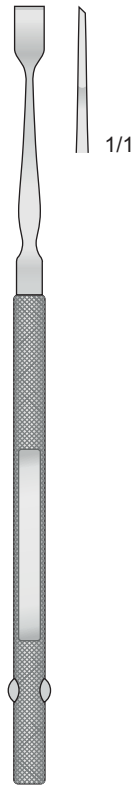
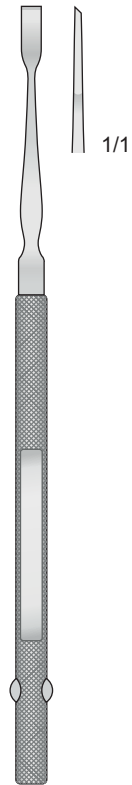
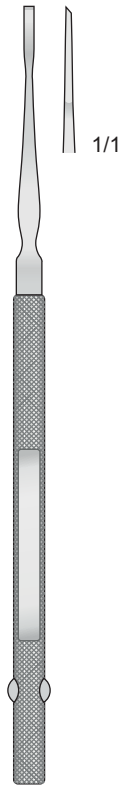
4 mm

6 mm

4 mm

4 mm

4 mm



**TG-10**  
160 mm

**TG-11**  
160 mm

**TG-12**  
160 mm

**TG-20**  
160 mm

**TG-21**  
160 mm

**TG-22**  
160 mm

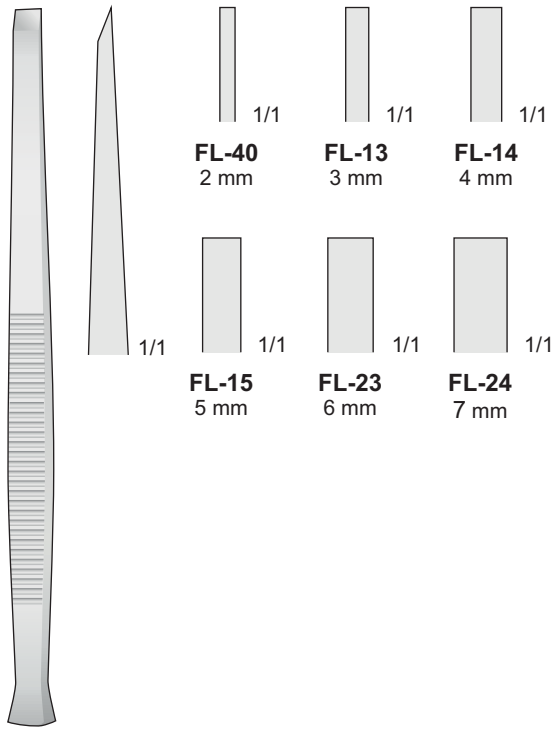
**FREER  
TG-23**  
160 mm

**BUCKLEY  
TG-40**  
160 mm

**BUCKLEY  
TG-41**  
160 mm

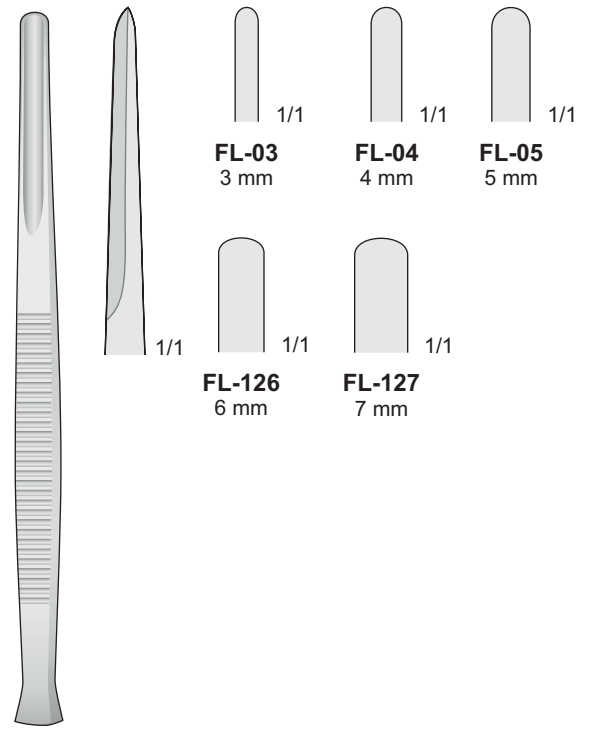


Osteotomi - Osteotomes  
Osteotome - Ostéotomes - Osteótomos



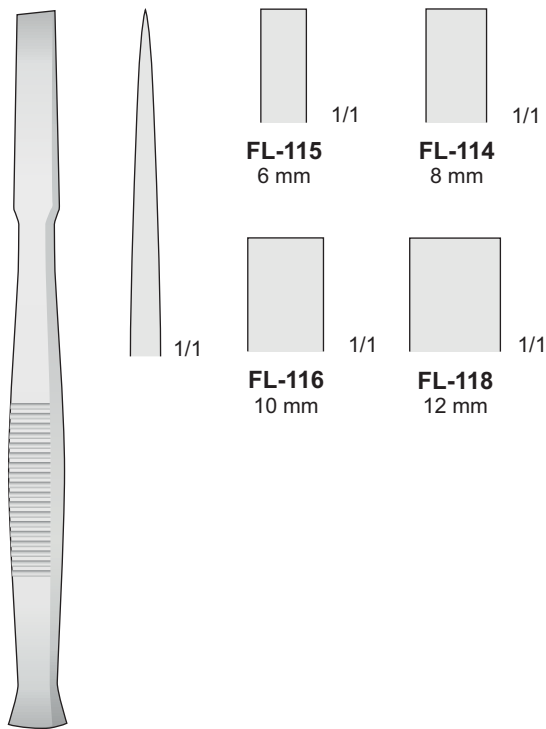
PARTSCH  
FL-13/FL-40  
140 mm

Sgorbie - Gouges  
Hohlmeissel - Gouges - Gubias



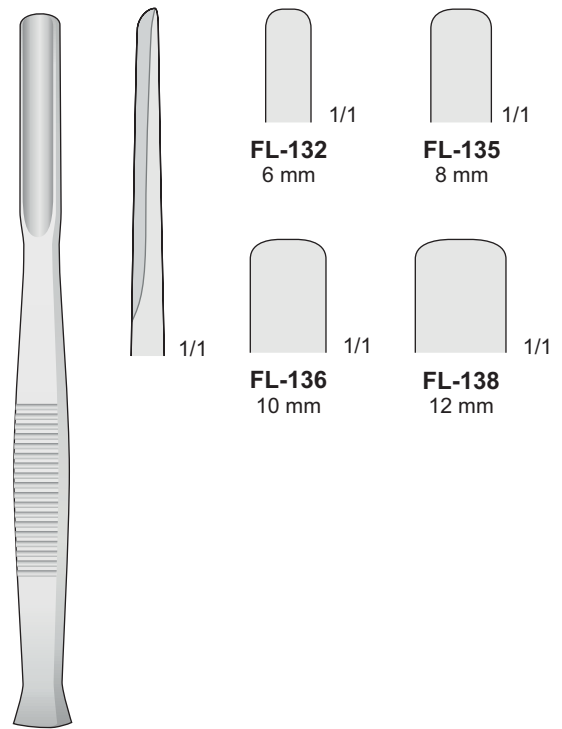
PARTSCH  
FL-03/FL-127  
140 mm

Osteotomi - Osteotomes  
Osteotome - Ostéotomes - Osteótomos

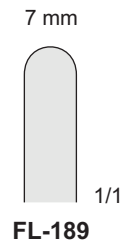
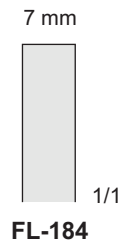
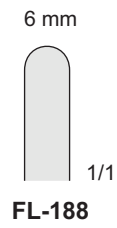
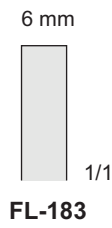
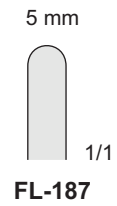
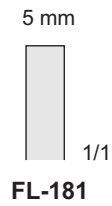
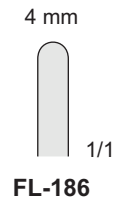
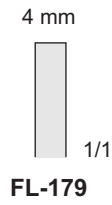
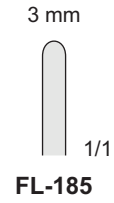
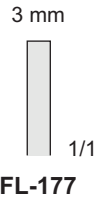


FL-114/FL-118  
140 mm

Sgorbie - Gouges  
Hohlmeissel - Gouges - Gubias

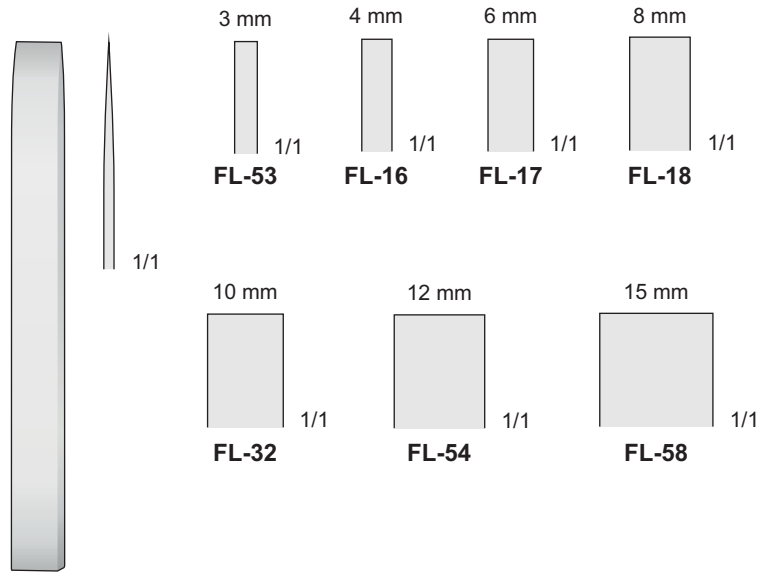


FL-132/FL-138  
140 mm

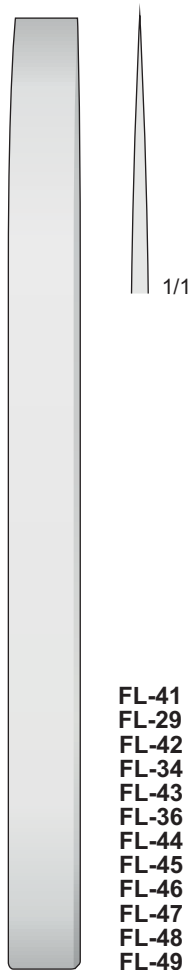


**PARTSCH**  
**FL-177/FL-184**  
170 mm

**PARTSCH**  
**FL-185/FL-189**  
170 mm

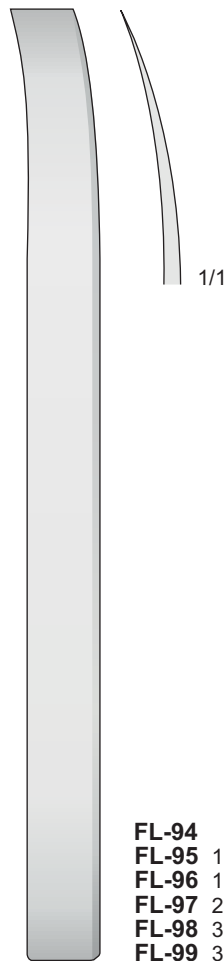


MINI-LAMBOTTE  
FL-16/FL-58  
125 mm



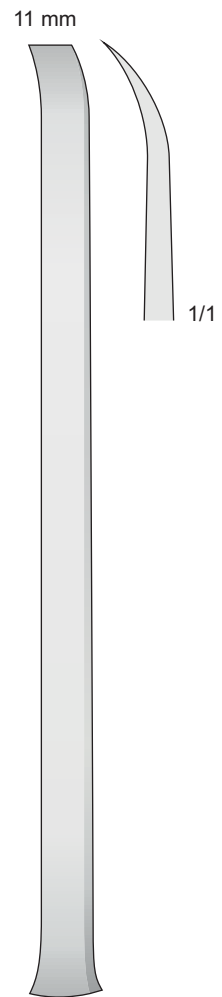
- FL-41 4 mm
- FL-29 8 mm
- FL-42 10 mm
- FL-34 13 mm
- FL-43 15 mm
- FL-36 18 mm
- FL-44 20 mm
- FL-45 25 mm
- FL-46 30 mm
- FL-47 38 mm
- FL-48 44 mm
- FL-49 50 mm

LAMBOTTE  
FL-41/FL-49  
250 mm



- FL-94 8 mm
- FL-95 13 mm
- FL-96 18 mm
- FL-97 25 mm
- FL-98 30 mm
- FL-99 38 mm

LAMBOTTE  
FL-94/FL-99  
250 mm



OBWEGESER  
DO-18  
235 mm



Osteotomi

Osteotomes

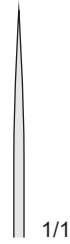
Osteotome

Ostéotomes

Osteòtomas

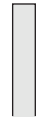


MINI-LAMBOTTE  
FL-263/FL-269  
170 mm



1/1

3 mm



1/1

FL-263

4 mm



1/1

FL-264

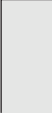
6 mm



1/1

FL-265

8 mm



1/1

FL-266

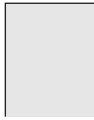
10 mm



1/1

FL-267

12 mm



1/1

FL-268

15 mm



1/1

FL-269

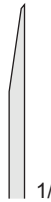
4 mm



1/1

COTTLE  
DO-130  
180 mm

7 mm



1/1

COTTLE  
DO-131  
180 mm

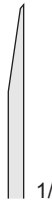
9 mm



1/1

COTTLE  
DO-132  
180 mm

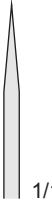
12 mm



1/1

COTTLE  
DO-133  
180 mm

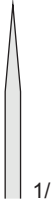
4 mm



1/1

COTTLE  
DO-140  
180 mm

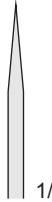
7 mm



1/1

COTTLE  
DO-141  
180 mm

12 mm



1/1

COTTLE  
DO-143  
180 mm





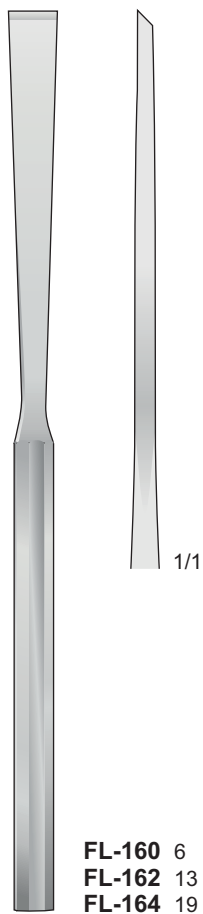
Osteotomi

Osteotomes

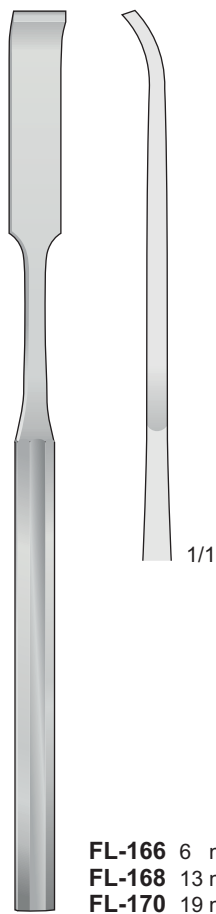
Osteotome

Ostéotomes

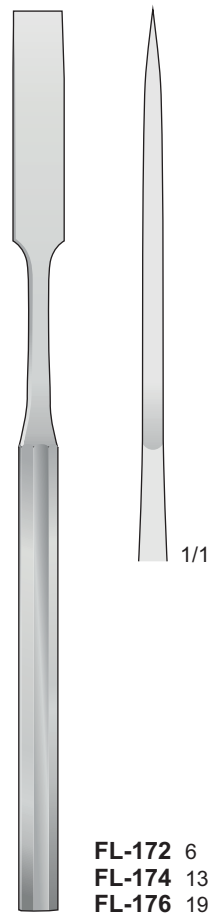
Osteòtoms



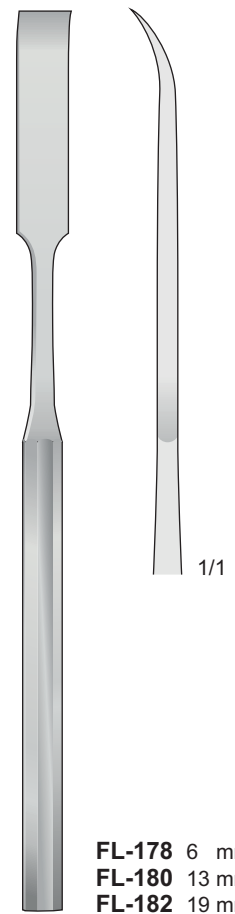
HIBBS  
**FL-160/FL-164**  
230 mm



HIBBS  
**FL-166/FL-170**  
230 mm



HIBBS  
**FL-172/FL-176**  
230 mm



HIBBS  
**FL-178/FL-182**  
230 mm



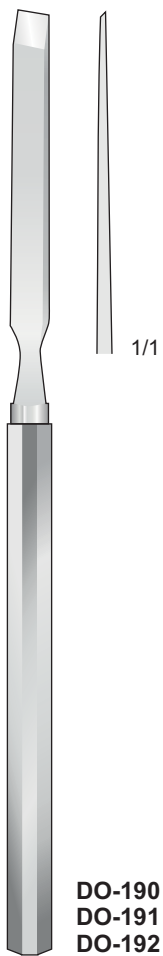
Osteotomi

Osteotomes

Osteotome

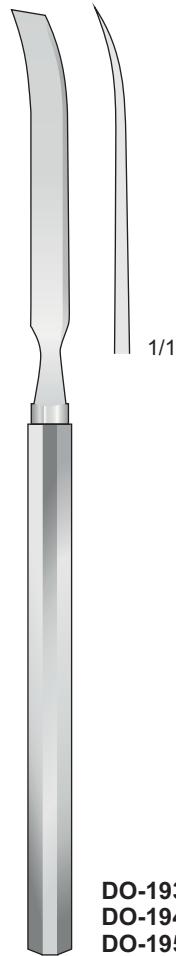
Ostéotomes

Osteòtoms



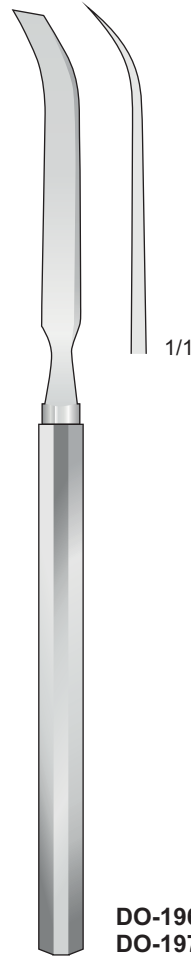
**DO-190** 4 mm  
**DO-191** 6 mm  
**DO-192** 8 mm

**DO-190/DO-192**  
180 mm



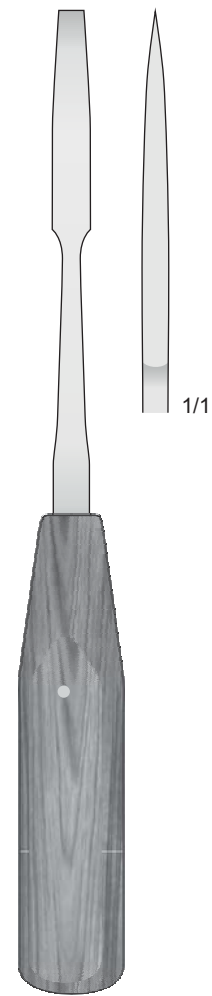
**DO-193** 4 mm  
**DO-194** 6 mm  
**DO-195** 8 mm

**DO-193/DO-195**  
180 mm



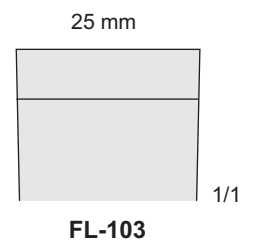
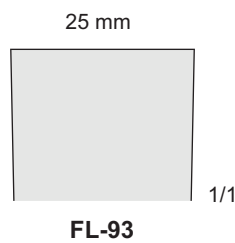
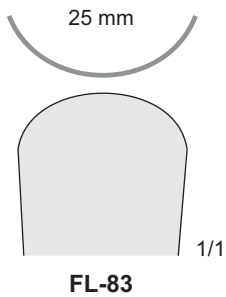
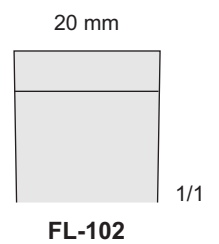
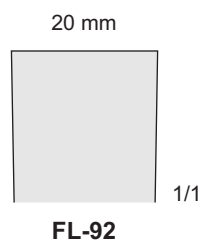
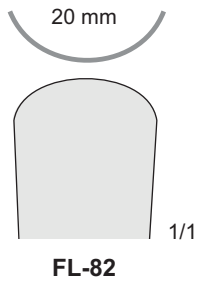
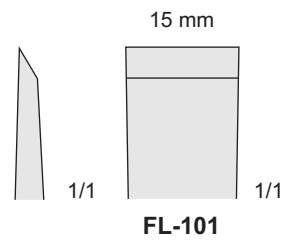
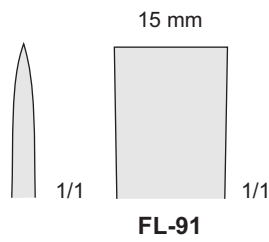
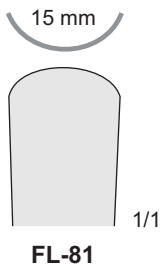
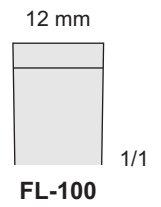
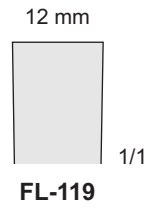
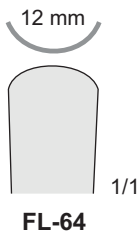
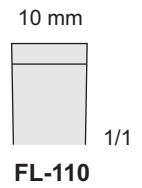
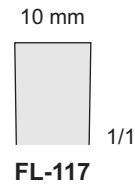
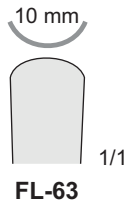
**DO-196** 6 mm  
**DO-197** 8 mm

**DO-196/DO-197**  
180 mm



2 mm  
1/1  
**FL-59**  
4 mm  
1/1  
**FL-60**  
6 mm  
1/1  
**FL-61**  
8 mm  
1/1  
**FL-62**

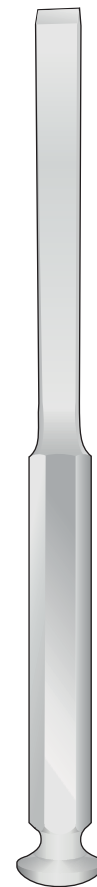
**MINI-LEXER**  
**FL-59/FL-62**  
200 mm



STILLE  
FL-63/FL-83  
200 mm



STILLE  
FL-91/FL-119  
200 mm



STILLE  
FL-100/FL-110  
200 mm



Osteotomi

Osteotomes

Osteotome

Ostéotomes

Osteòtoms

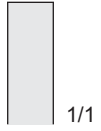
6 mm



1/1

**FL-340**

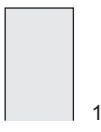
6 mm



1/1

**FL-347**

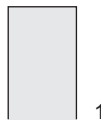
9 mm



1/1

**FL-341**

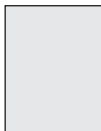
9 mm



1/1

**FL-348**

13 mm



1/1

**FL-342**

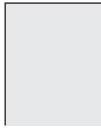
13 mm



1/1

**FL-349**

16 mm



1/1

**FL-343**

16 mm



1/1

**FL-350**

19 mm



1/1

**FL-344**

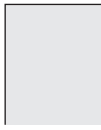
19 mm



1/1

**FL-351**

25 mm



1/1

**FL-345**

25 mm



1/1

**FL-352**

32 mm



1/1

**FL-346**

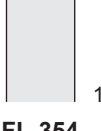
32 mm



1/1

**FL-353**

9 mm



1/1

**FL-354**

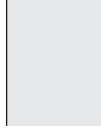
9 mm



1/1

**FL-359**

13 mm



1/1

**FL-355**

13 mm



1/1

**FL-360**

19 mm



1/1

**FL-356**

19 mm



1/1

**FL-361**

25 mm



1/1

**FL-357**

25 mm



1/1

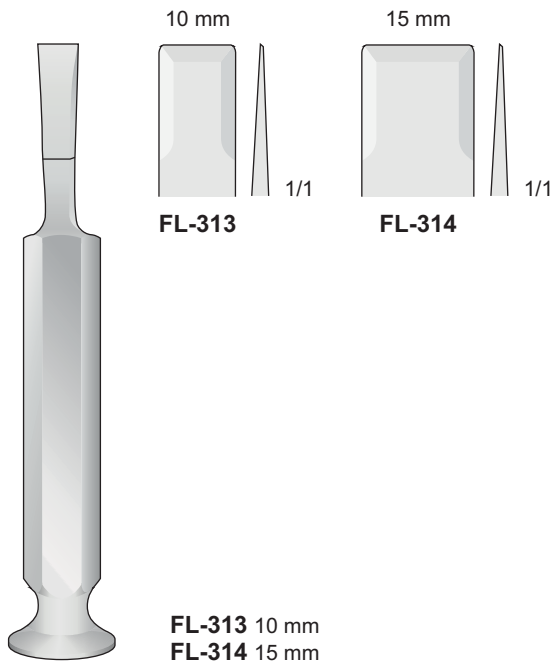
**FL-362**

SMITH-PETERSEN  
**FL-340/FL-346**  
200 mm

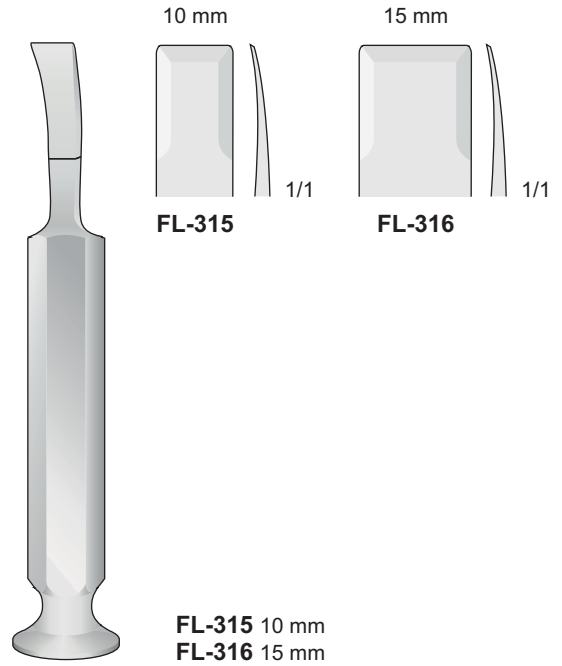
SMITH-PETERSEN  
**FL-347/FL-353**  
200 mm

SMITH-PETERSEN  
**FL-354/FL-357**  
200 mm

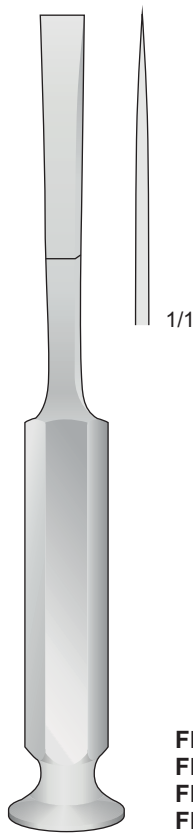
SMITH-PETERSEN  
**FL-359/FL-362**  
200 mm



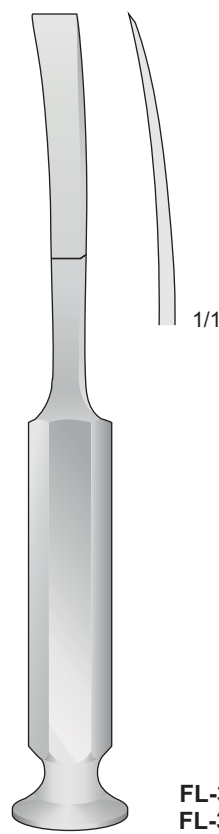
TESSIER  
**FL-313/FL-314**  
160 mm



TESSIER  
**FL-315/FL-316**  
160 mm



TESSIER  
**FL-307/FL-310**  
200 mm



TESSIER  
**FL-311/FL-312**  
200 mm



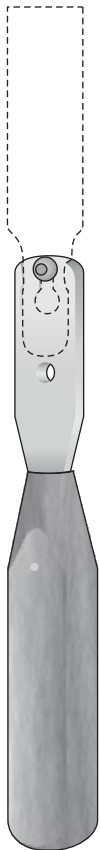
**FL-90**

Set completo di  
Set complete with  
Komplettset mit  
Set complet avec  
Set completo con

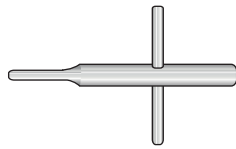
1 Manico portalamo in ferrozell  
1 With Ferrozell handle  
1 Mit Ferrozellgriff  
1 Avec poignée en Ferrozell  
1 Con mango de Ferrozell

4 Lame Fig. 1-2-3-4  
4 Blades Fig. 1-2-3-4  
4 Klingen Fig. 1-2-3-4  
4 Lames Fig. 1-2-3-4  
4 Hojas Fig. 1-2-3-4

1 Chiave ferma lama  
1 Key to hold on blade  
1 Schlüssel zum klingen anziehen  
1 Clef ferme lame  
1 Clave ferma hoja

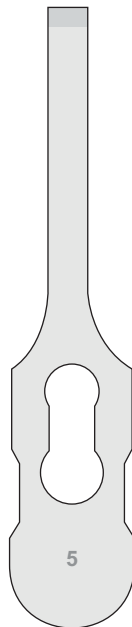


**FL-85**  
190 mm



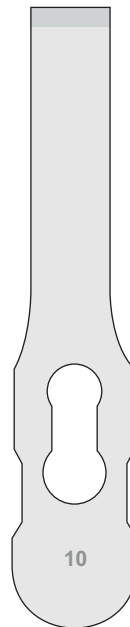
**FL-84**  
90 mm

Fig. 1  
5 mm



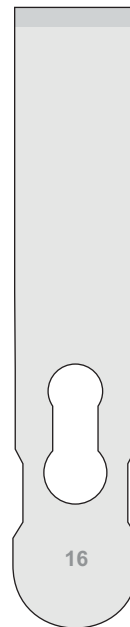
**FL-86**  
85 mm

Fig. 2  
10 mm



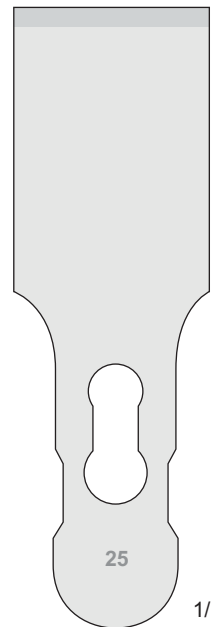
**FL-87**  
85 mm

Fig. 3  
16 mm

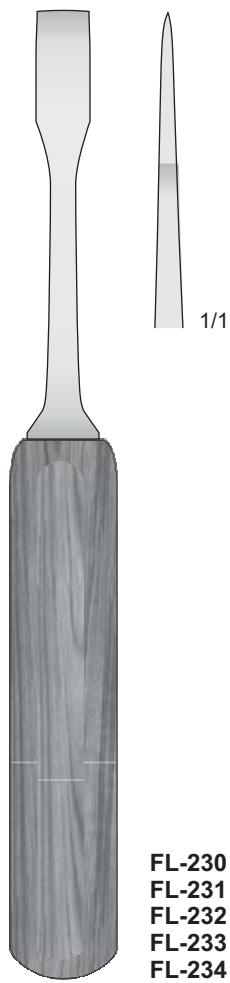


**FL-88**  
85 mm

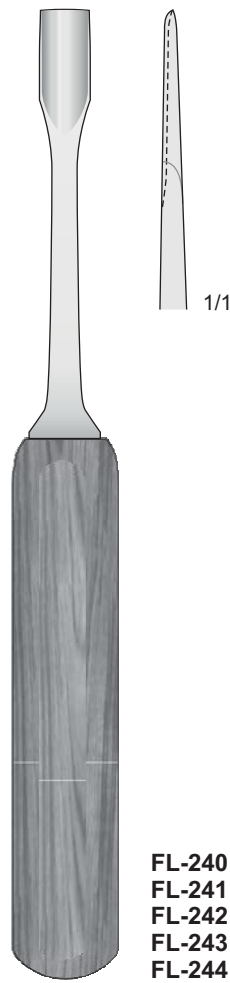
Fig. 4  
25 mm



**FL-89**  
85 mm



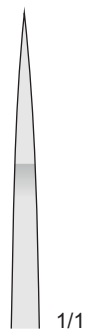
**MINI-LEXER**  
**FL-230/FL-234**  
180 mm



**MINI-LEXER**  
**FL-240/FL-244**  
180 mm

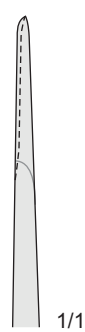


**LEXER**  
**FL-190/FL-194**  
180 mm



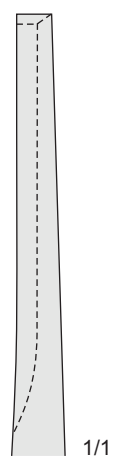
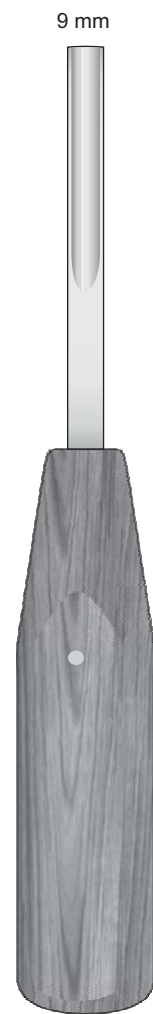
- FL-210** 5 mm
- FL-211** 7 mm
- FL-212** 10 mm
- FL-213** 15 mm
- FL-214** 20 mm
- FL-215** 25 mm
- FL-216** 30 mm

LEXER  
**FL-210/FL-216**  
220 mm



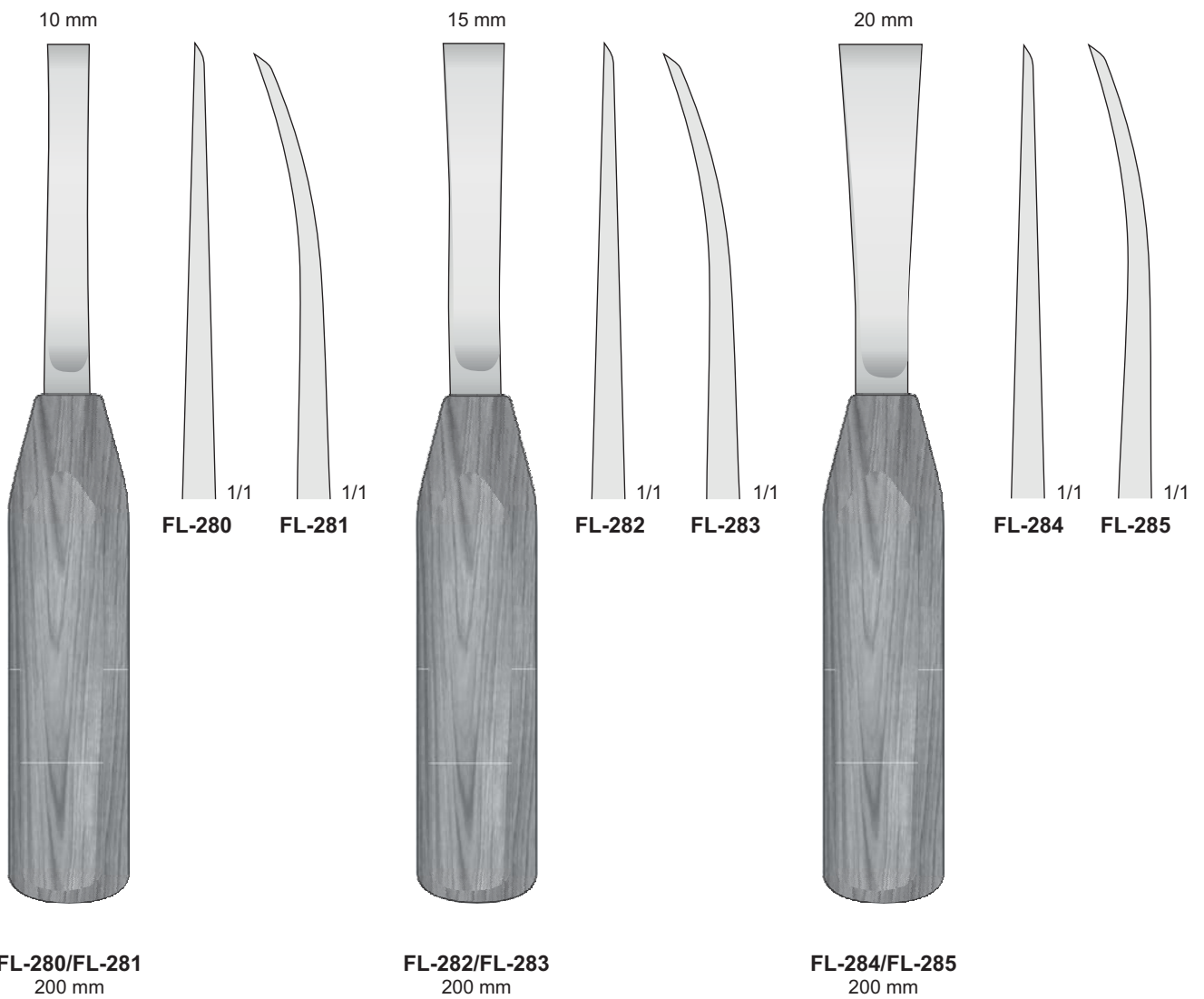
- FL-220** 5 mm
- FL-221** 7 mm
- FL-222** 10 mm
- FL-223** 15 mm
- FL-224** 20 mm
- FL-225** 25 mm
- FL-226** 30 mm

LEXER  
**FL-220/FL-226**  
220 mm



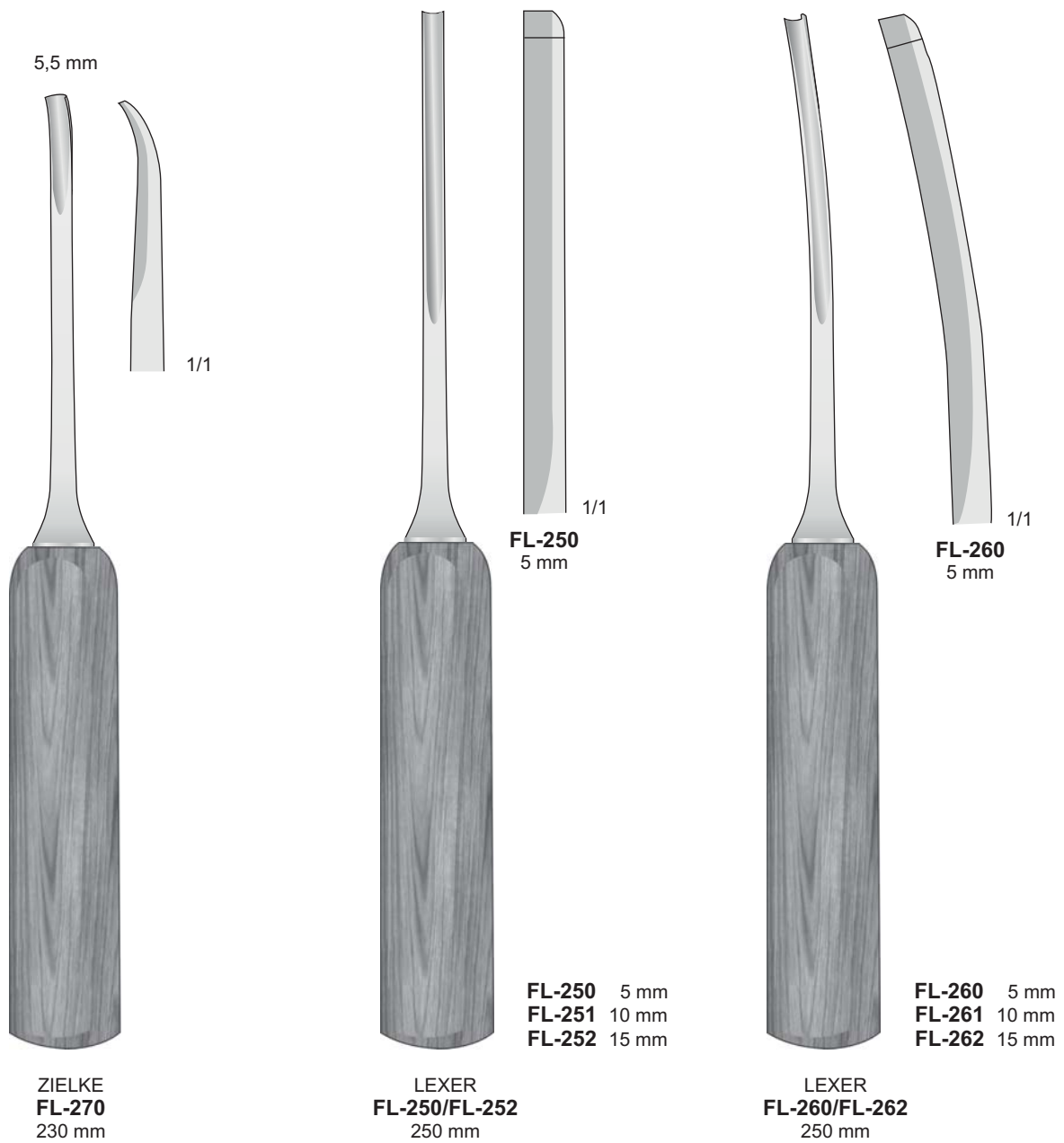
**FL-272**  
220 mm

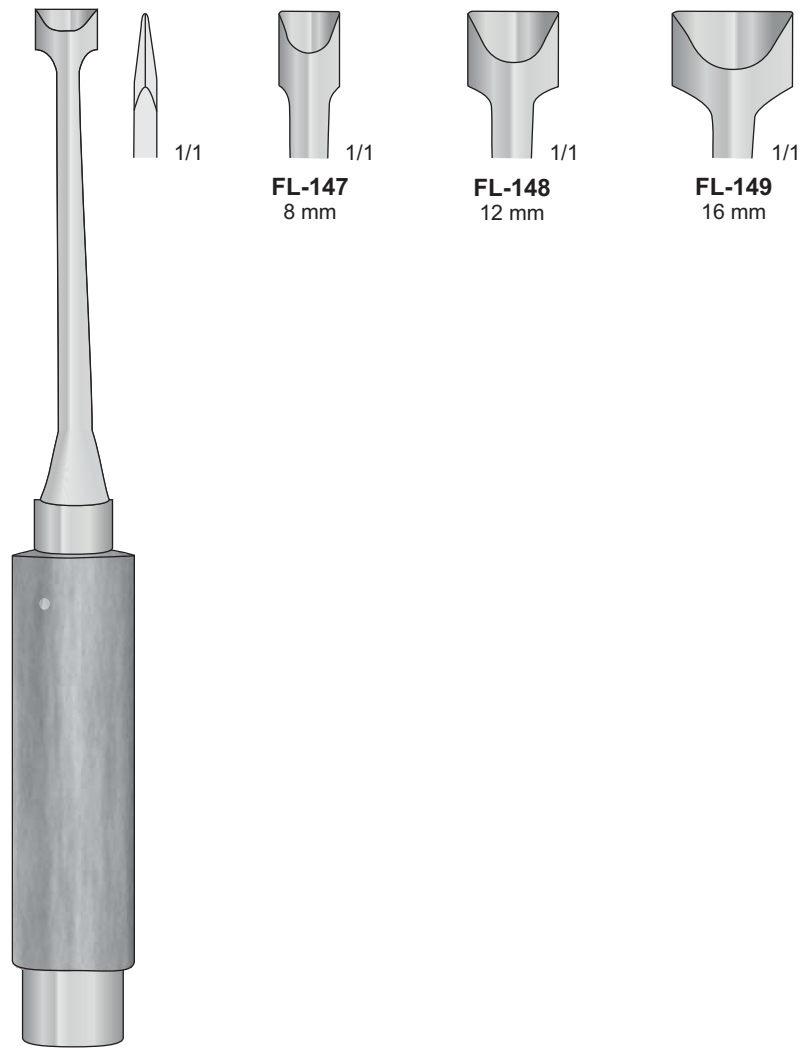




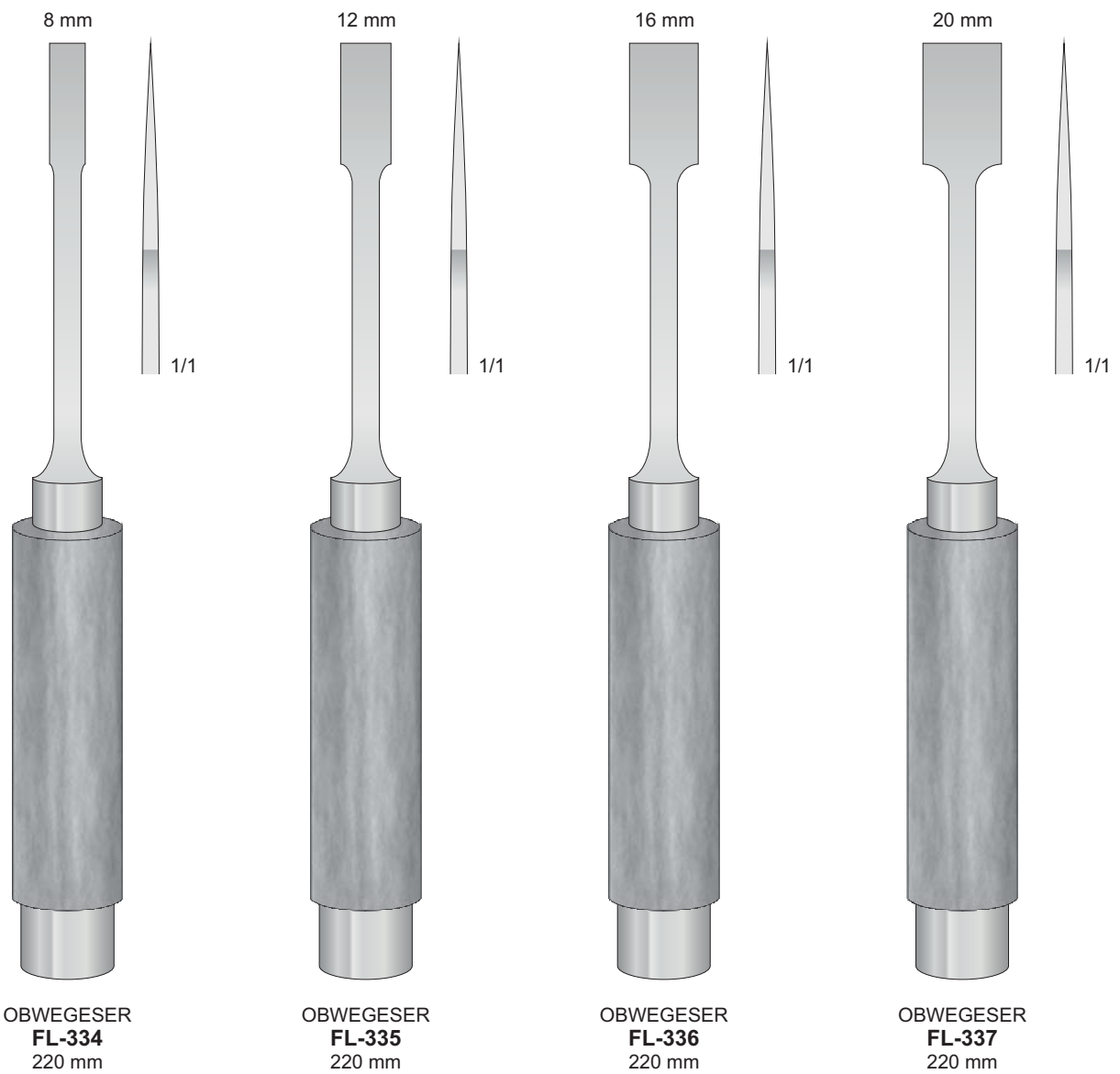


Sgorbie - Gouges  
Hohlmeissel - Gouges - Gubias





OBWEGESER  
**FL-147/FL-149**  
220 mm





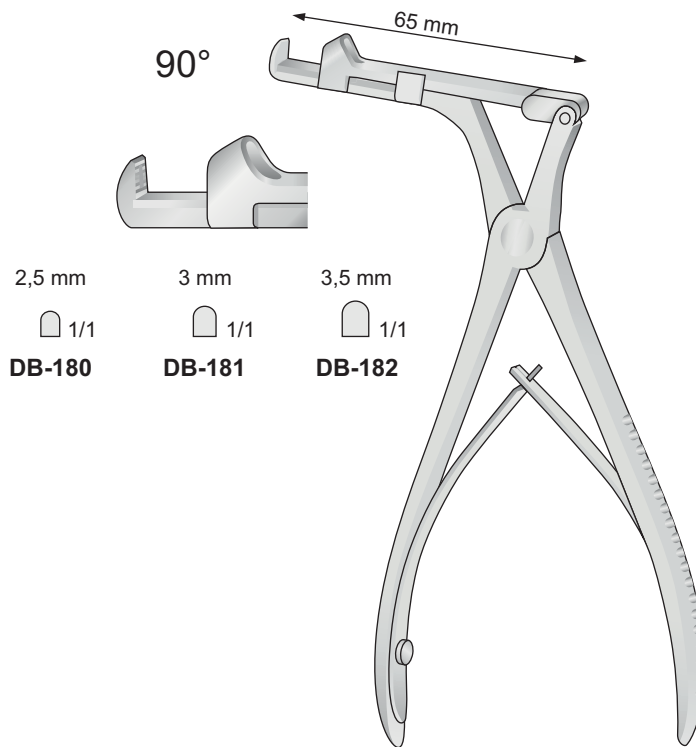
13

Laminotomi, Pinze ossivore  
Laminectomy, Bone rongeurs  
Laminektomie, Hohlmeisselzangen  
Laminectomy, Pincés Gouges  
Laminectomia, Pinzas Gubias

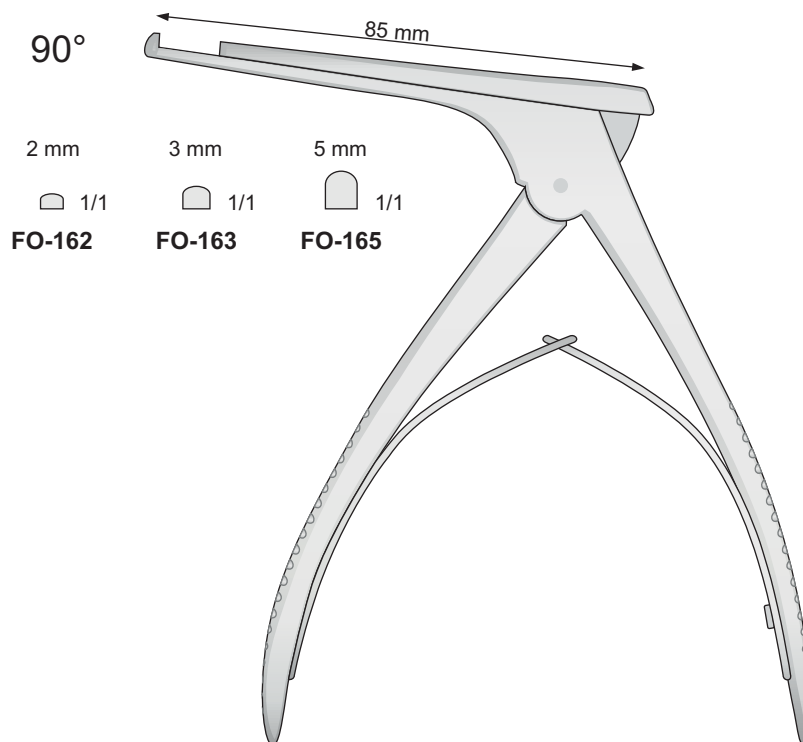




Punches - Stanzen



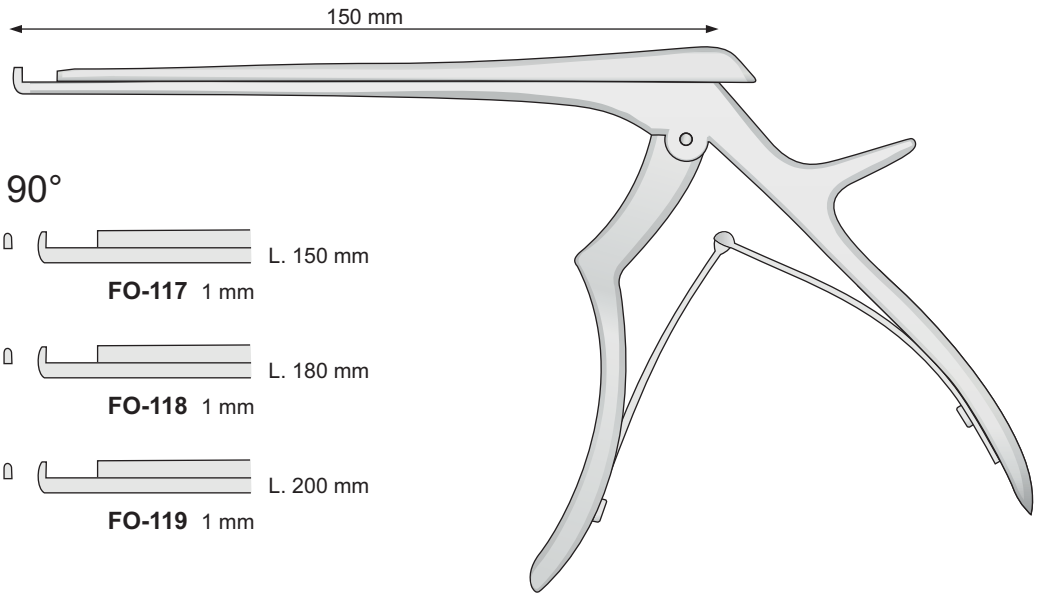
CITELLI  
**DB-180** 2,5 mm  
**DB-181** 3 mm  
**DB-182** 3,5 mm



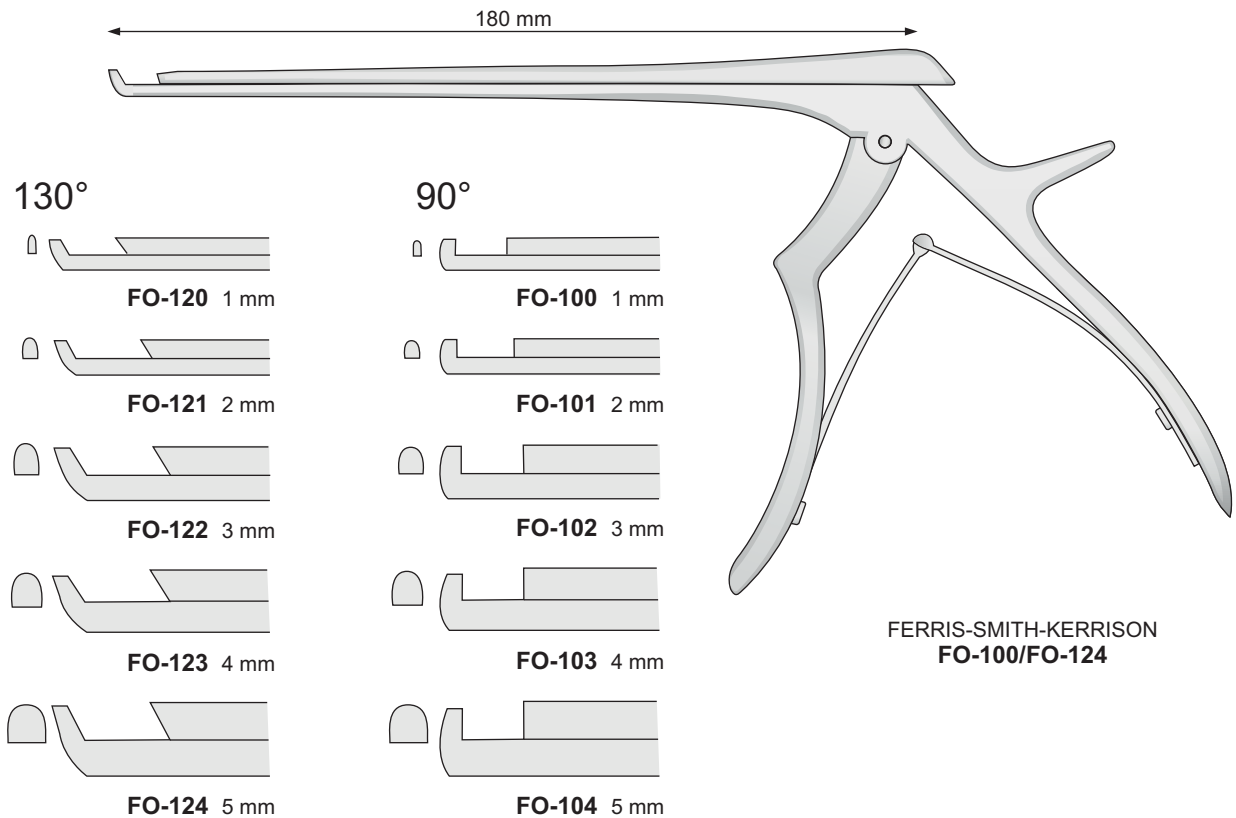
KERRISON  
**FO-162** 2 mm  
**FO-163** 3 mm  
**FO-165** 5 mm



Punches - Stanzen

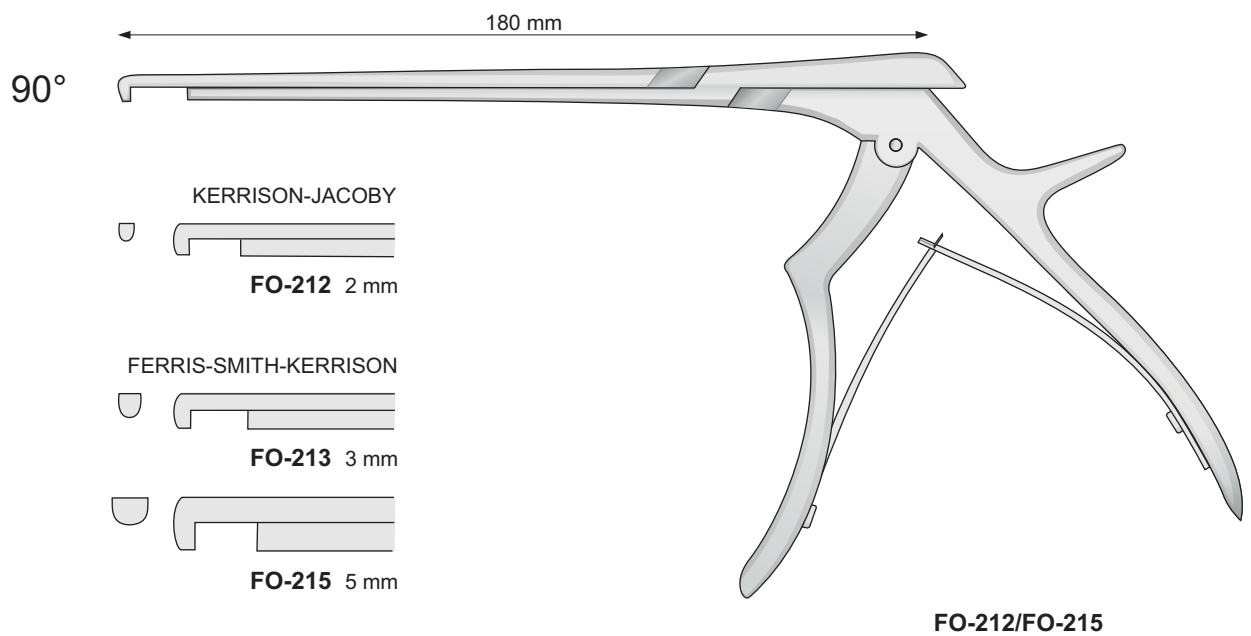
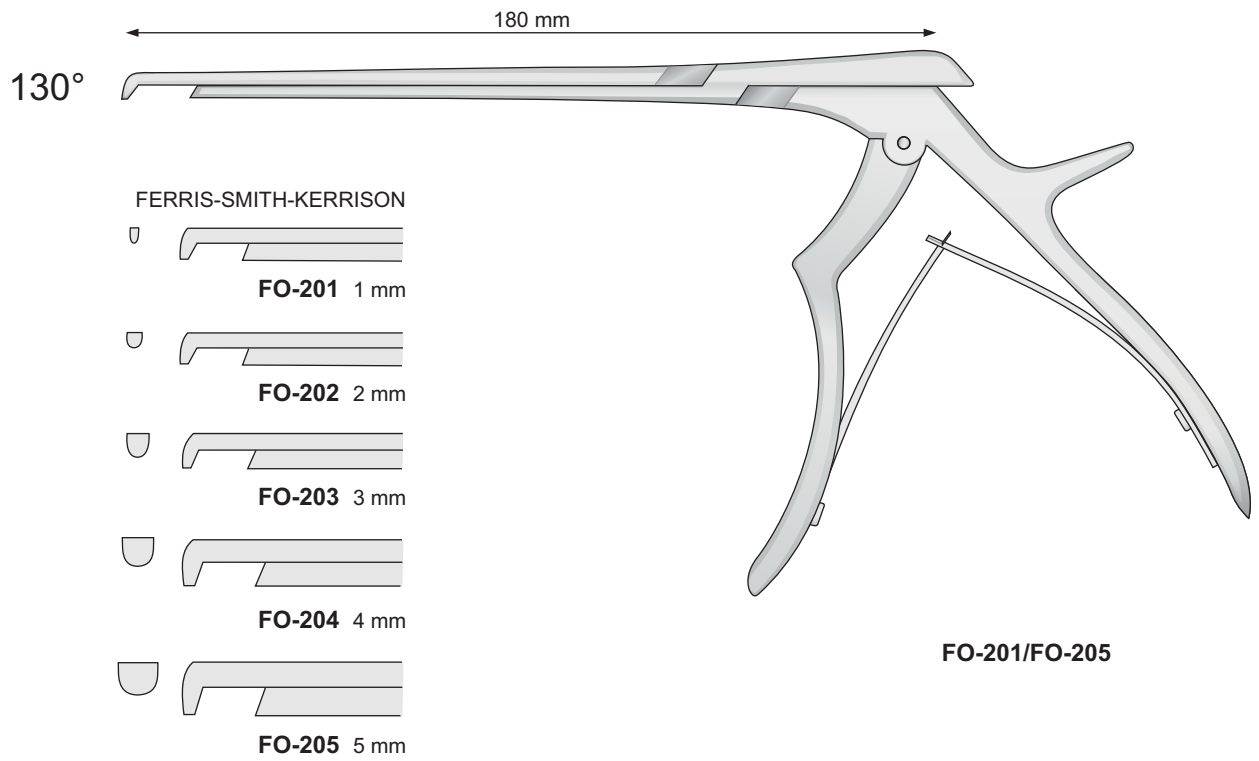


FERRIS-SMITH-KERRISON  
FO-117/FO-119



FERRIS-SMITH-KERRISON  
FO-100/FO-124







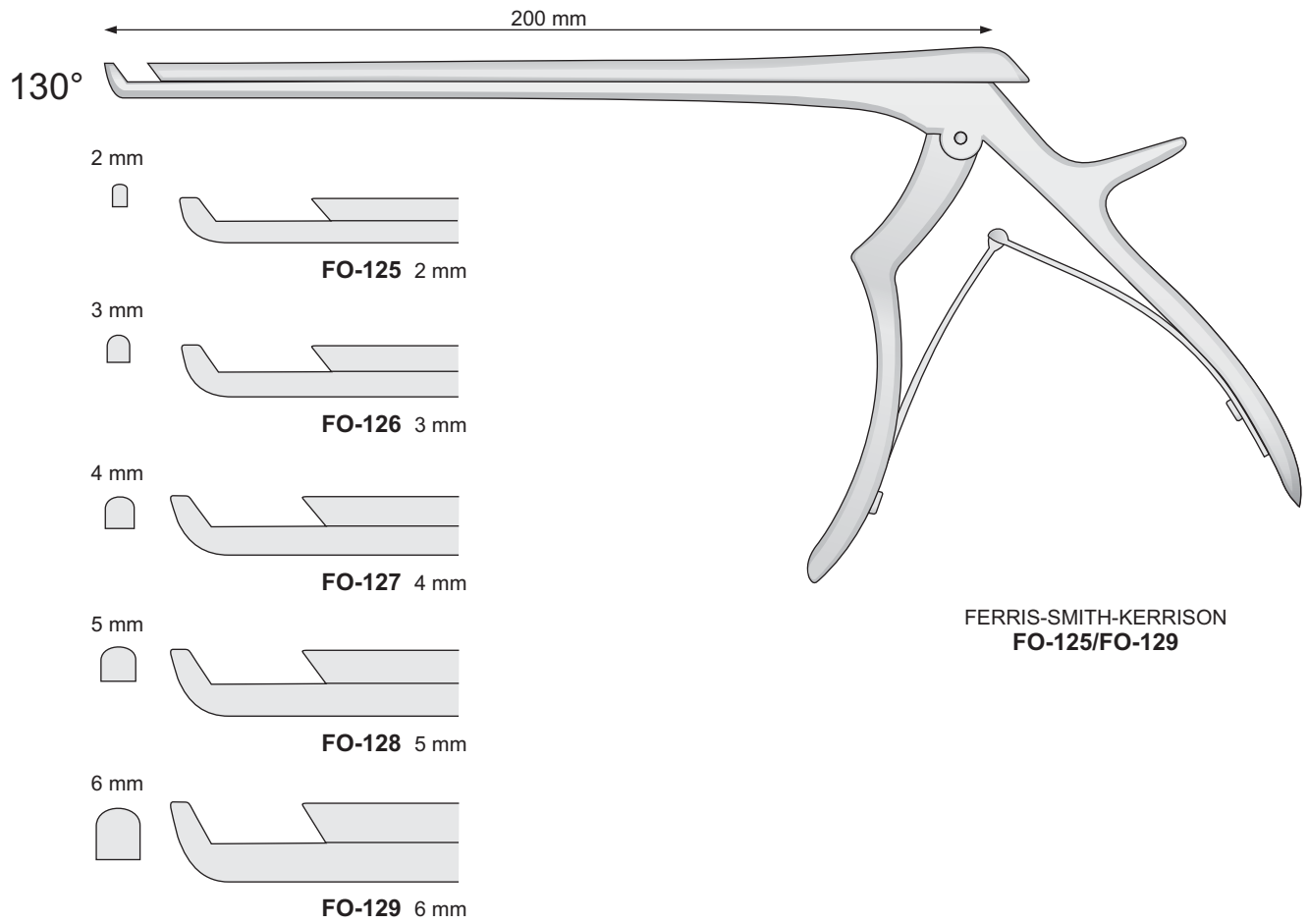
Laminectomia

Laminectomy

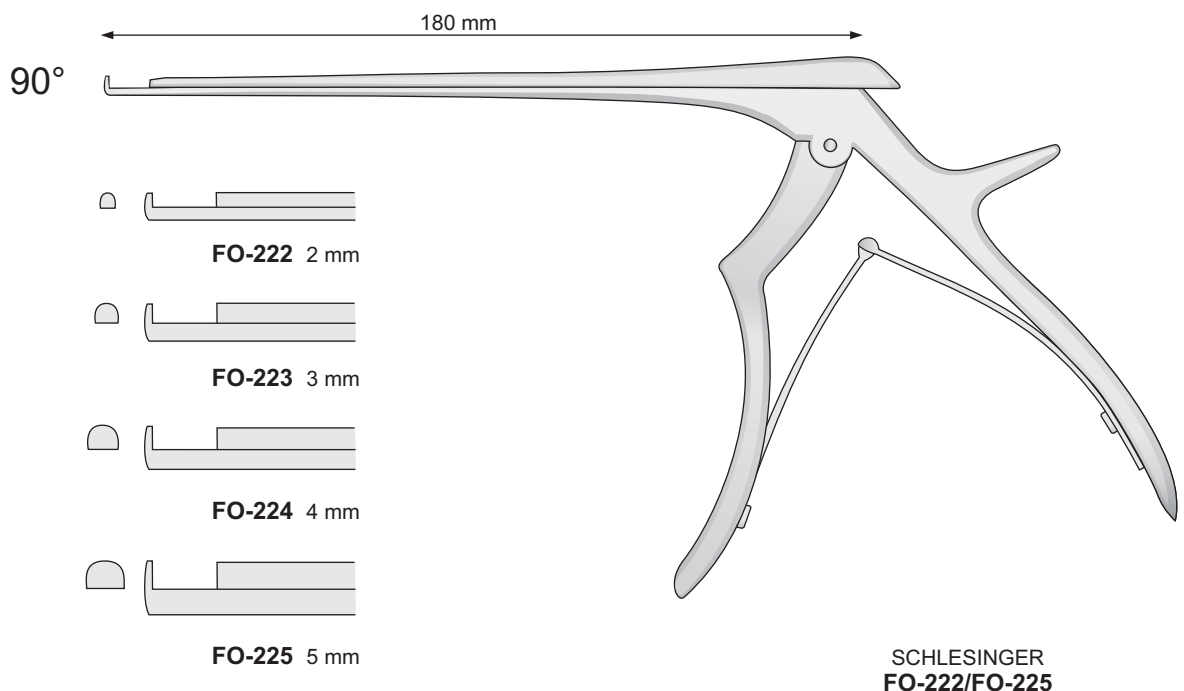
Laminektomie

Laminectomie

Laminectomia

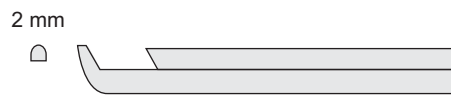


Laminotomo cervicale - Cervical Laminectomy

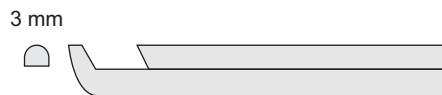




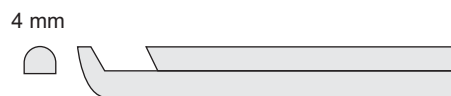
**FO-171**



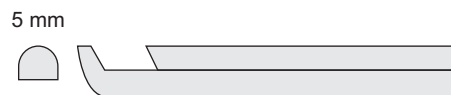
**FO-172**



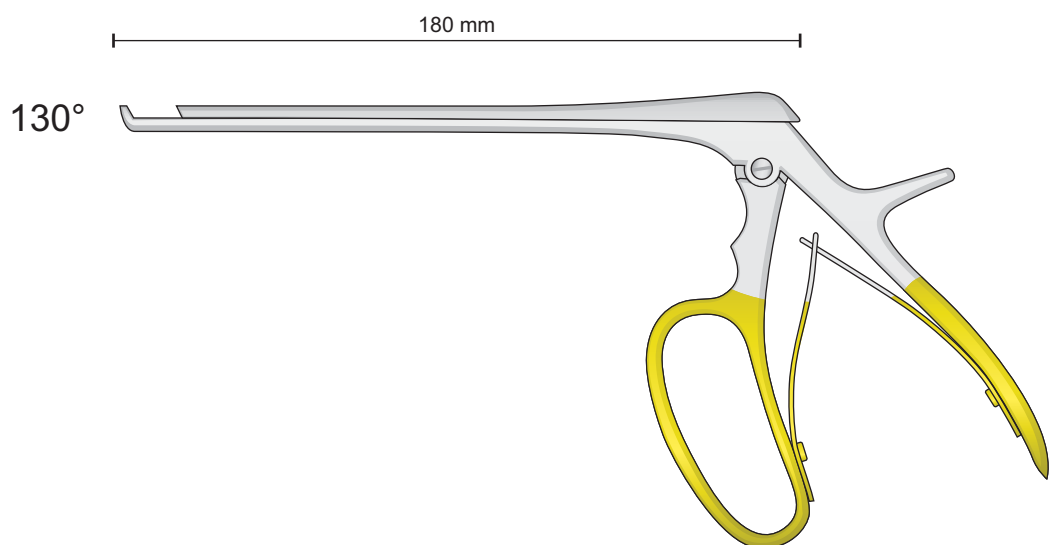
**FO-173**



**FO-174**



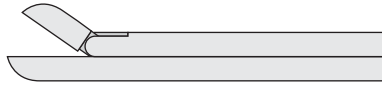
**FO-175**



**FERRIS - SMITH - KERRISON  
FO-171/FO-175**

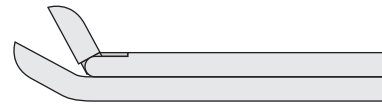


Diritta  
Stright  
Gerade  
Droites  
Rectas



	<b>FO-180</b>	2 x 10 mm
	<b>FO-181</b>	3 x 10 mm
	<b>FO-182</b>	4 x 10 mm
	<b>FO-183</b>	6 x 12 mm

Curva verso l'alto  
Top curved  
Aufwärtsgebogen  
Courbe vers le haut  
Curvos

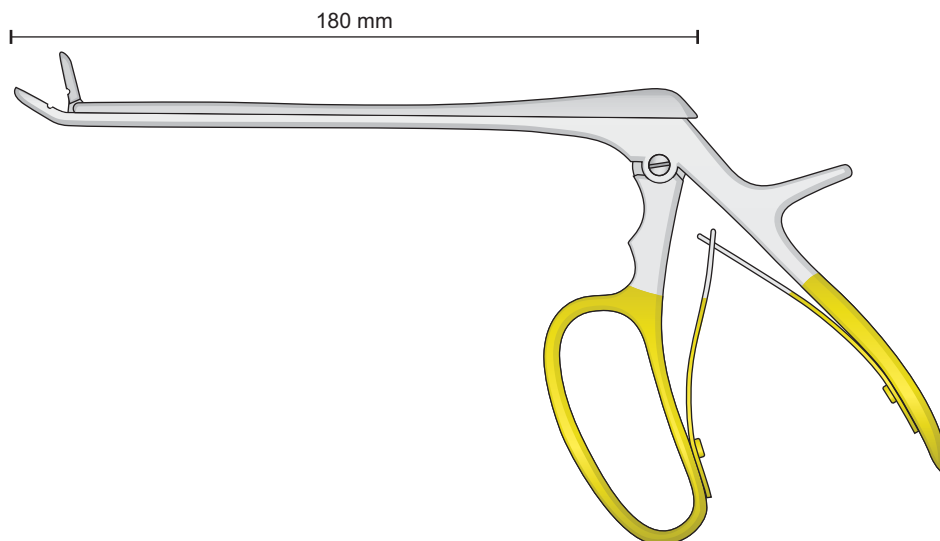


	<b>FO-184</b>	2 x 10 mm
	<b>FO-185</b>	3 x 10 mm
	<b>FO-186</b>	4 x 10 mm

Curva verso il basso  
Bottom curved  
Abwärts gebogen  
Courbe vers le bas  
Curvos



	<b>FO-187</b>	2 x 10 mm
	<b>FO-188</b>	3 x 10 mm
	<b>FO-189</b>	4 x 10 mm



FERRIS - SMITH - CUSHING  
FO-180/FO-189



Pinze  
per biopsia

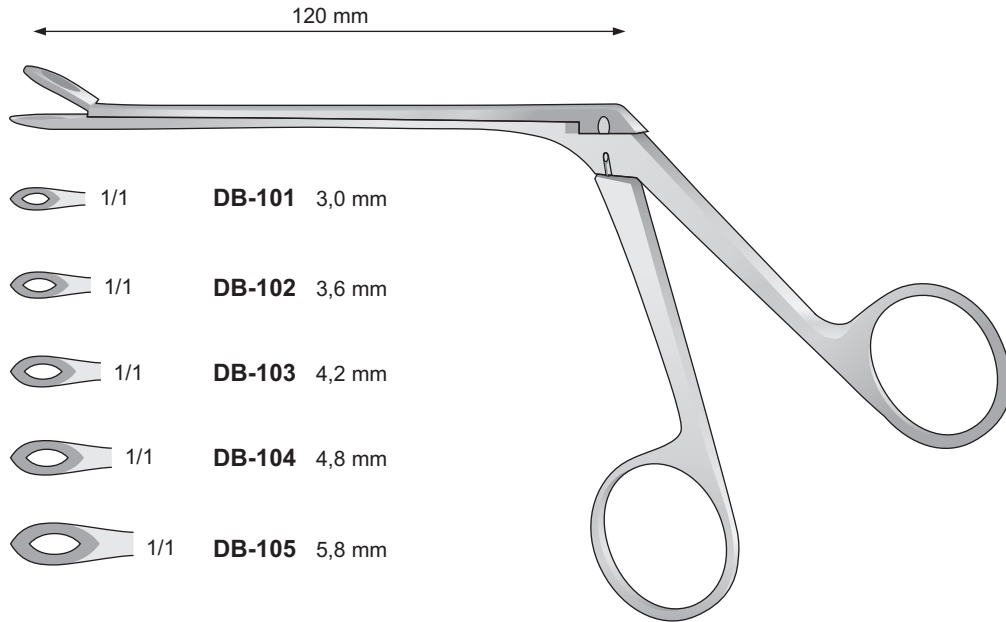
Laminectomy  
rongeurs

Laminectomy  
Rongeurs

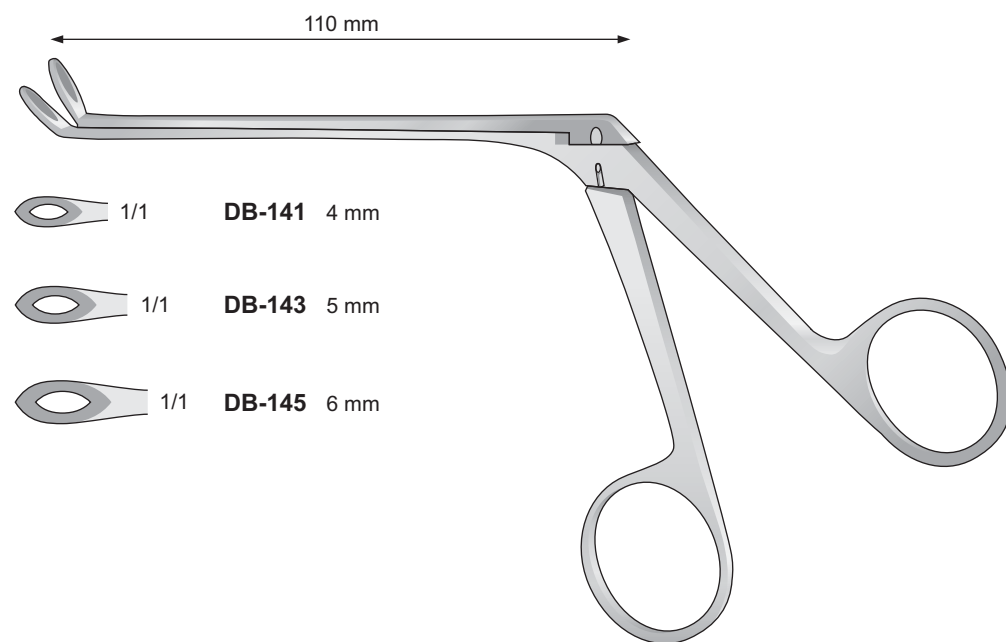
Pinces a  
laminectomia

Pinzas cortantes  
para laminectomia

Rongeurs - Rongeurs



WEIL-BLAKESLEY  
**DB-101/DB-105**  
190 mm



WEIL-BLAKESLEY  
**DB-141/DB-145**  
190 mm



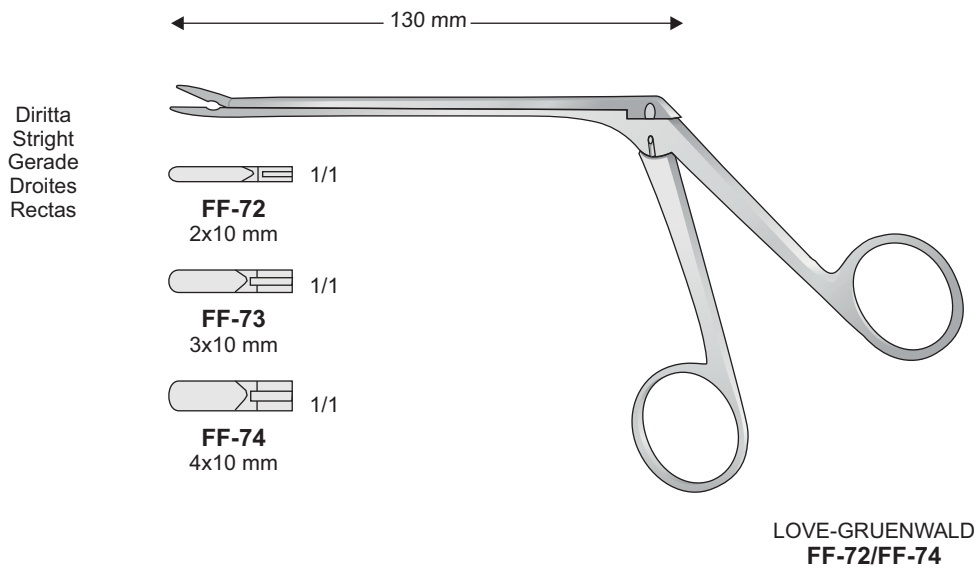
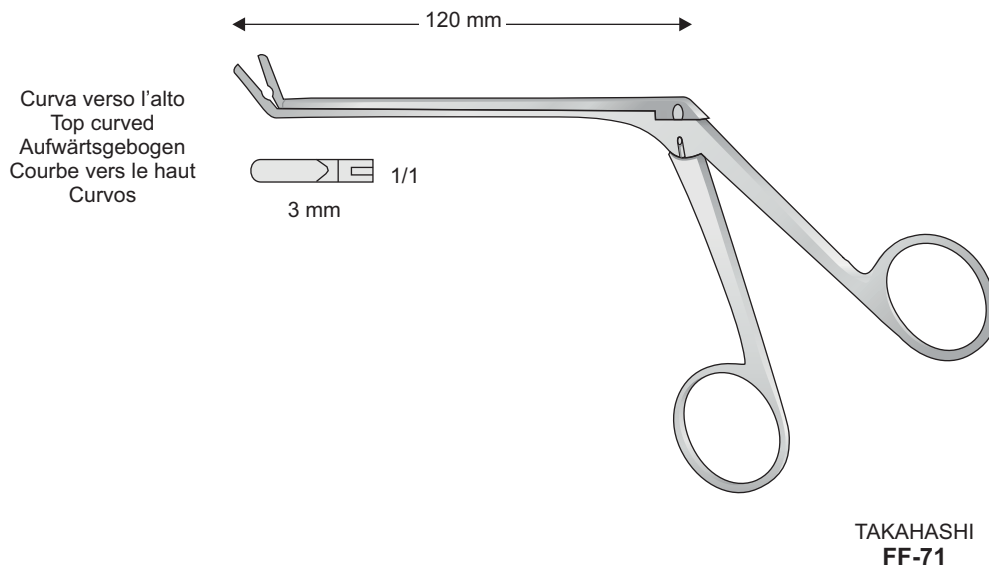
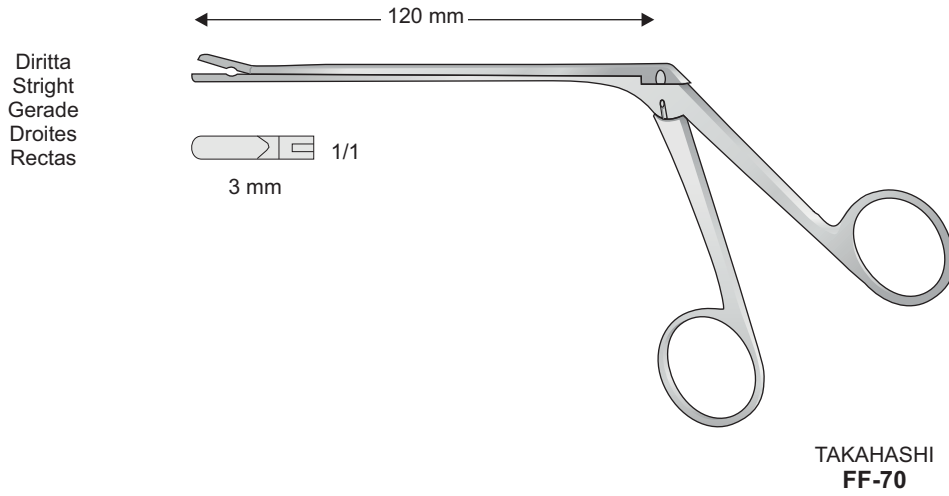
Pinze  
per biopsia

Laminectomy  
rongeurs

Laminectomy  
Rongeur

Pinces a  
laminectomia

Pinzas cortantes  
para laminectomia





Pinze  
per biopsia

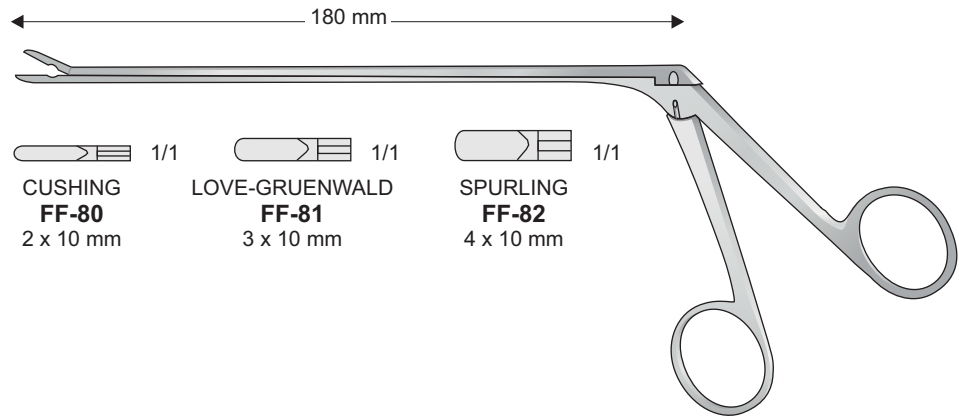
Laminectomy  
rongeurs

Laminectomy  
Rongeur

Pincas a  
laminectomia

Pinzas cortantes  
para laminectomia

Diritta  
Stright  
Gerade  
Droites  
Rectas



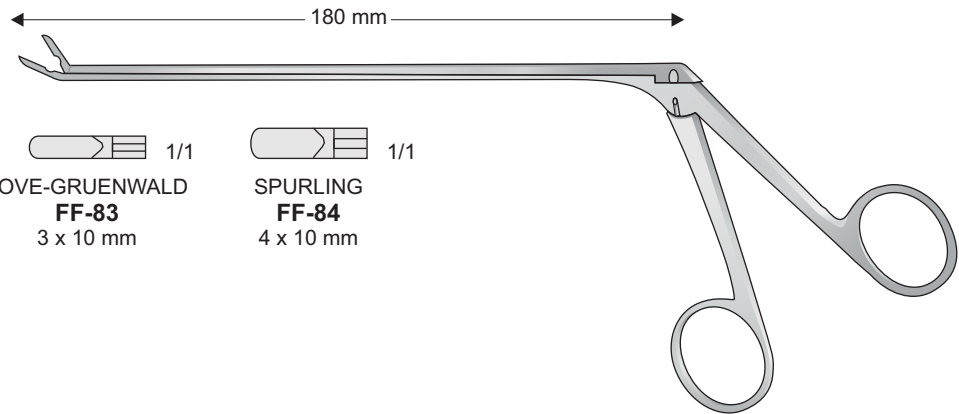
CUSHING  
**FF-80**  
2 x 10 mm

LOVE-GRUENWALD  
**FF-81**  
3 x 10 mm

SPURLING  
**FF-82**  
4 x 10 mm

**FF-80/FF-82**

Curva verso l'alto  
Top curved  
Aufwärtsgebogen  
Courbe vers le haut  
Curvos

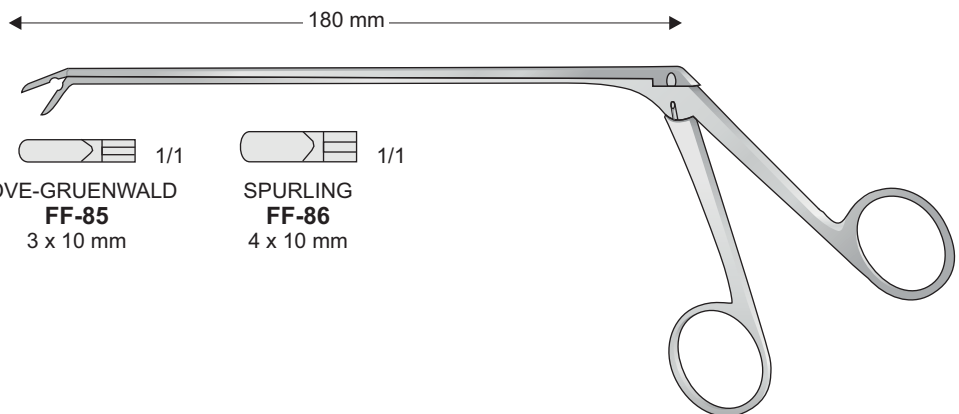


LOVE-GRUENWALD  
**FF-83**  
3 x 10 mm

SPURLING  
**FF-84**  
4 x 10 mm

**FF-83/FF-84**

Curva verso il basso  
Bottom curved  
Abwärts gebogen  
Courbe vers le bas  
Curvos



LOVE-GRUENWALD  
**FF-85**  
3 x 10 mm

SPURLING  
**FF-86**  
4 x 10 mm

**FF-85/FF-86**



Pinze  
per biopsia

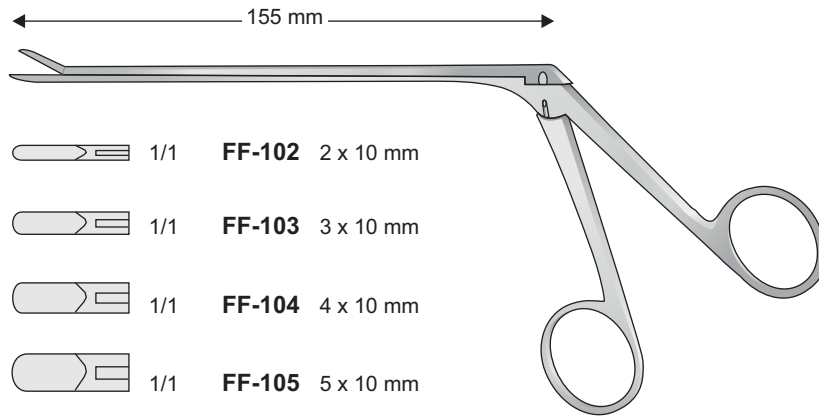
Laminectomy  
rongeurs





Laminectomy  
Rongeur

Pinces a  
laminectomia

Pinzas cortantes  
para laminectomia

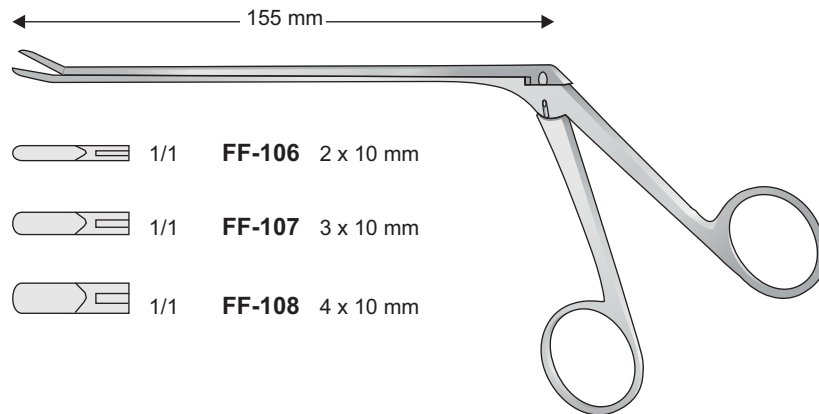
Diritta  
Stright  
Gerade  
Droites  
Rectas



-  1/1 **FF-102** 2 x 10 mm
-  1/1 **FF-103** 3 x 10 mm
-  1/1 **FF-104** 4 x 10 mm
-  1/1 **FF-105** 5 x 10 mm

CASPAR  
FF-102/FF-105

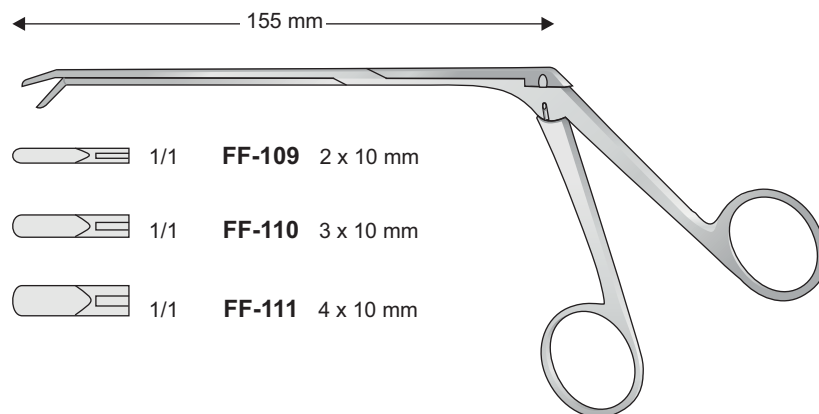
Curva verso l'alto  
Top curved  
Aufwärtsgebogen  
Courbe vers le haut  
Curvos



-  1/1 **FF-106** 2 x 10 mm
-  1/1 **FF-107** 3 x 10 mm
-  1/1 **FF-108** 4 x 10 mm

CASPAR  
FF-106/FF-108

Curva verso il basso  
Bottom curved  
Abwärts gebogen  
Courbe vers le bas  
Curvos



-  1/1 **FF-109** 2 x 10 mm
-  1/1 **FF-110** 3 x 10 mm
-  1/1 **FF-111** 4 x 10 mm

CASPAR  
FF-109/FF-111





Pinze  
per biopsia

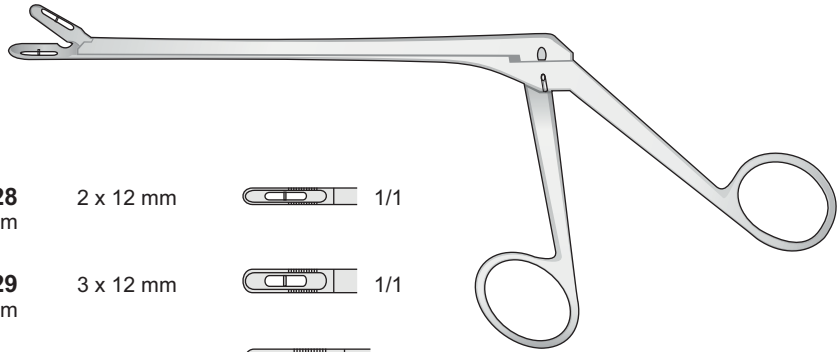
Laminectomy  
rongeurs

Laminectomy  
Rongeur

Pinces a  
laminectomia

Pinzas cortantes  
para laminectomia

Diritta  
Stright  
Gerade  
Droites  
Rectas



CASPAR

**FF-120**  
140 mm

**FF-123**  
160 mm

**FF-128**  
185 mm

2 x 12 mm

 1/1

**FF-121**  
140 mm

**FF-124**  
160 mm

**FF-129**  
185 mm

3 x 12 mm

 1/1

**FF-122**  
140 mm

**FF-125**  
160 mm

**FF-130**  
185 mm

4 x 14 mm

 1/1

**FF-126**  
160 mm

**FF-131**  
185 mm

5 x 14 mm

 1/1

**FF-127**  
160 mm

**FF-132**  
185 mm

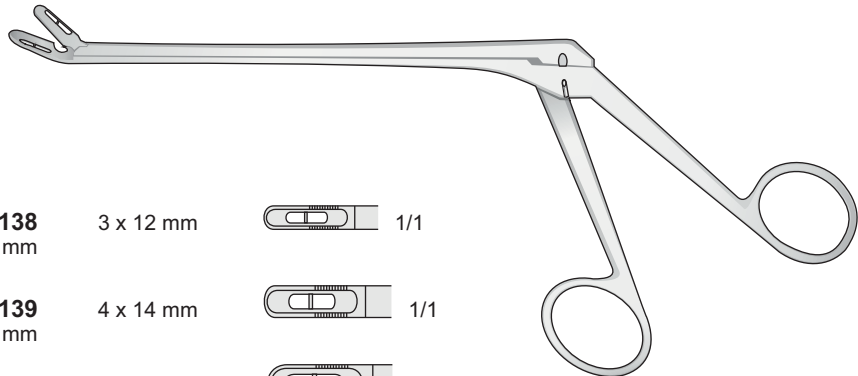
6 x 16 mm

 1/1

CASPAR  
**FF-120/FF-132**

Curva verso l'alto  
Top curved  
Aufwärtsgebogen  
Courbe vers le haut  
Curvos

150°



CASPAR

**FF-133**  
140 mm

**FF-135**  
160 mm

**FF-138**  
185 mm

3 x 12 mm

 1/1

**FF-134**  
140 mm

**FF-136**  
160 mm

**FF-139**  
185 mm

4 x 14 mm

 1/1

**FF-137**  
160 mm

**FF-140**  
185 mm

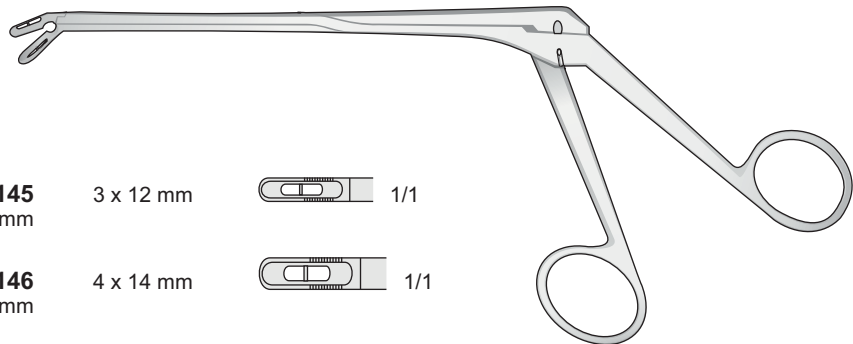
5 x 14 mm

 1/1

CASPAR  
**FF-133/FF-140**

Curva verso il basso  
Bottom curved  
Abwärts gebogen  
Courbe vers le bas  
Curvos

150°



CASPAR

**FF-141**  
140 mm

**FF-143**  
160 mm

**FF-145**  
185 mm

3 x 12 mm

 1/1

**FF-142**  
140 mm

**FF-144**  
160 mm

**FF-146**  
185 mm

4 x 14 mm

 1/1

CASPAR  
**FF-141/FF-146**



Pinze  
per biopsia

Laminectomy  
rongeurs

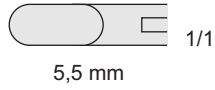
Laminectomy  
Rongeur

Pinces a  
laminectomia

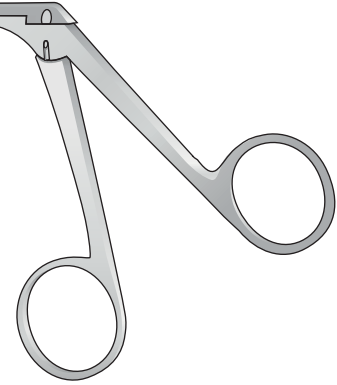
Pinzas cortantes  
para laminectomia

Diritta  
Stright  
Gerade  
Droites  
Rectas

210 mm



5,5 mm



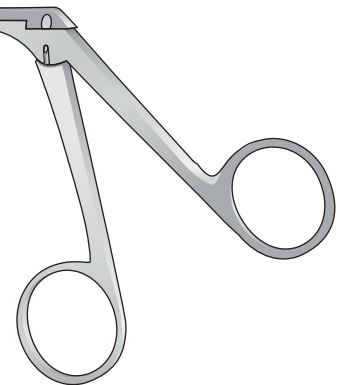
WAGNER  
FF-90

Diritta  
Stright  
Gerade  
Droites  
Rectas

255 mm



5,3 mm



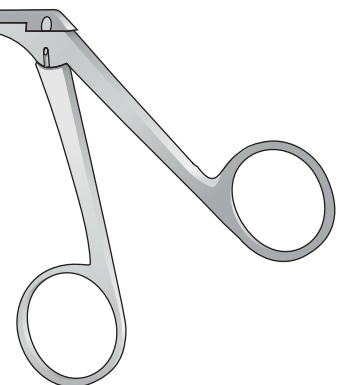
FF-91

Curva verso l'alto  
Top curved  
Aufwärtsgebogen  
Courbe vers le haut  
Curvos

255 mm



5,8 mm



SYPERT  
FF-92



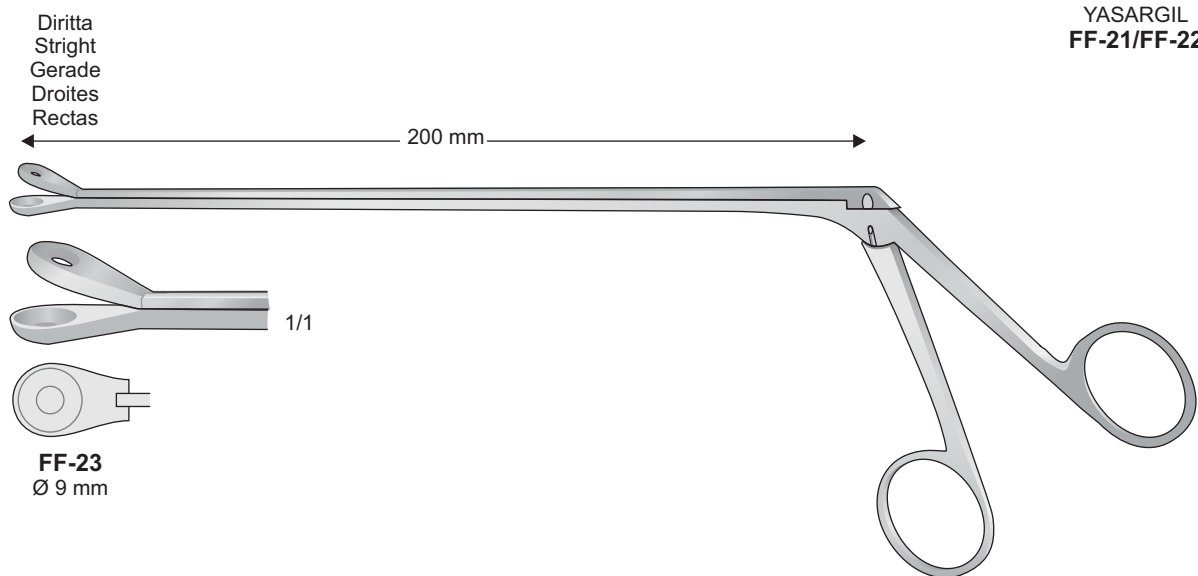
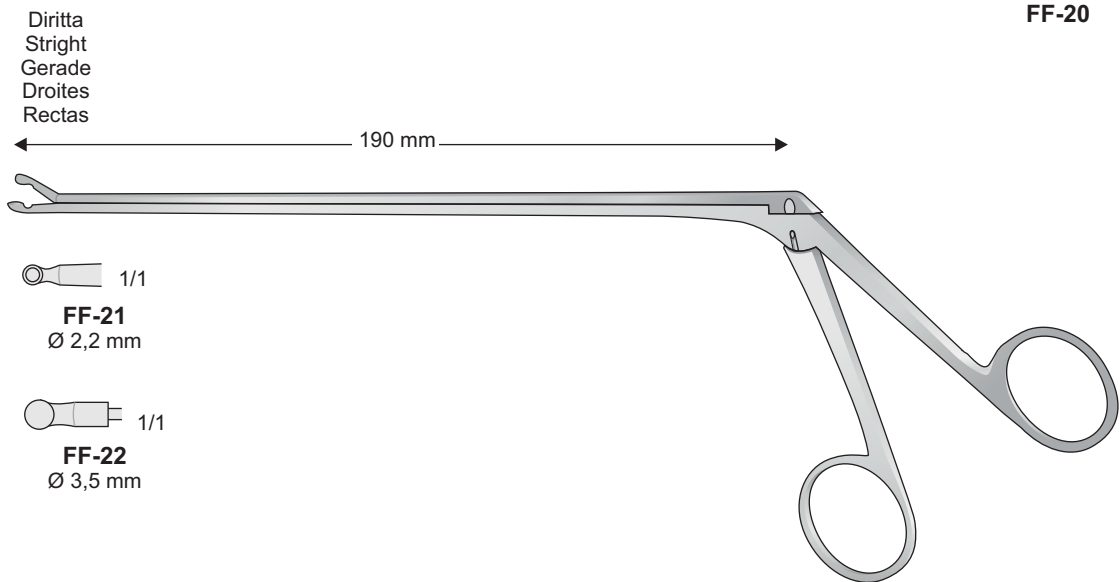
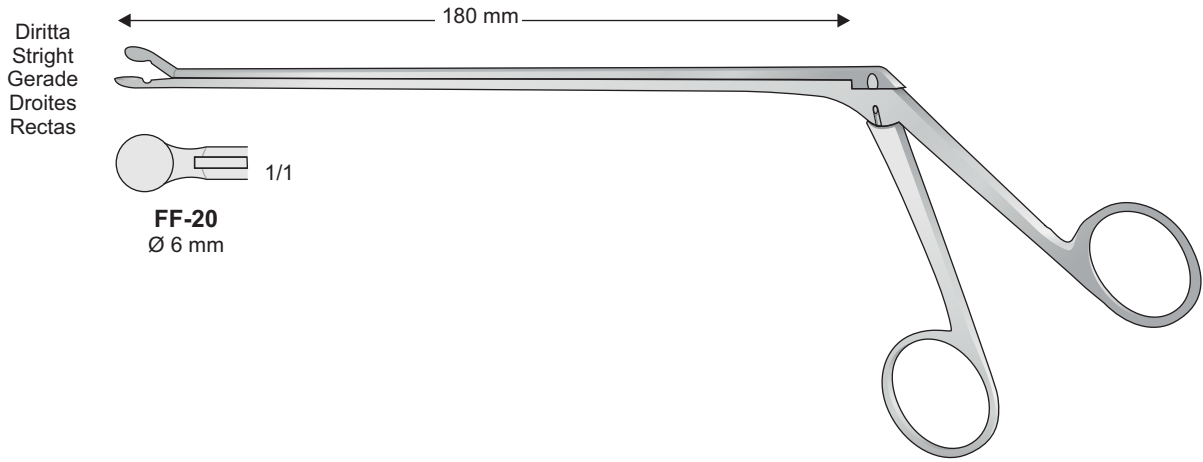
Pinze  
per biopsia

Laminectomy  
rongeurs

Laminectomy  
Rongeurs

Pinças a  
laminectomia

Pinzas cortantes  
para laminectomia





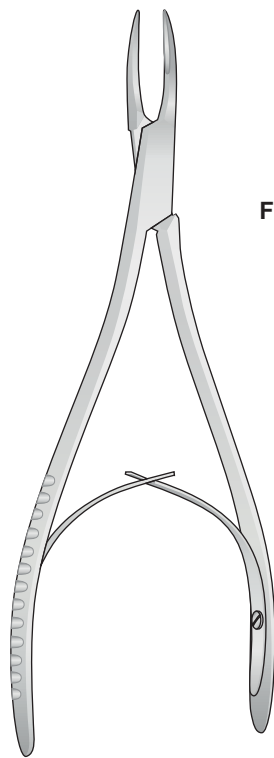
Pinze ossivore

Bone rongeurs

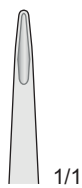
Hohlmeißelzangen

Pinces-gouges

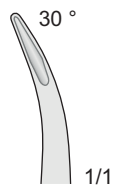
Pinza-gubias



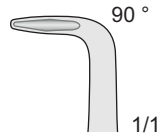
MINI-FRIEDMANN  
FO-22/FO-24  
150 mm



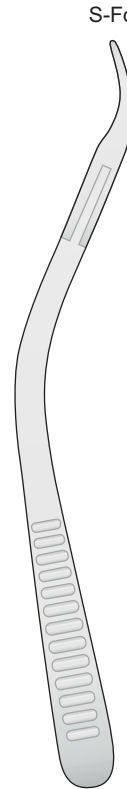
FO-23



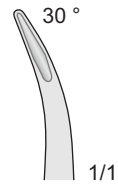
FO-22



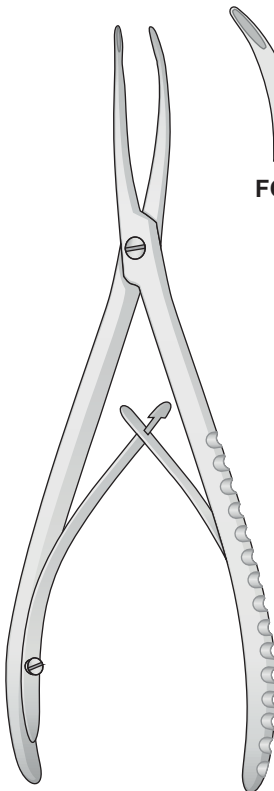
FO-24



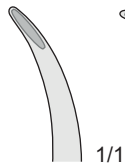
MINI-FRIEDMANN  
FO-85  
145 mm



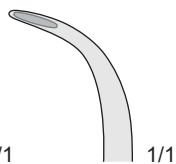
FO-85



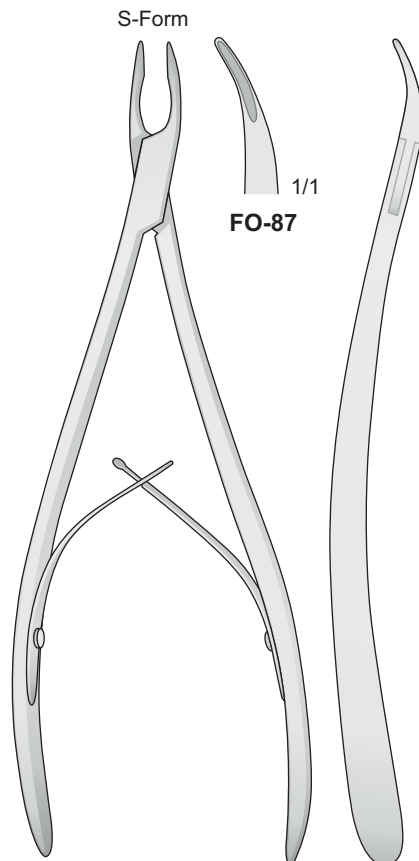
STELLBRINK  
FO-88/FO-89  
170 mm



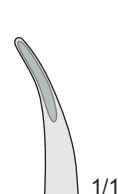
FO-88



FO-89



STELLBRINK  
FO-87  
190 mm



FO-87



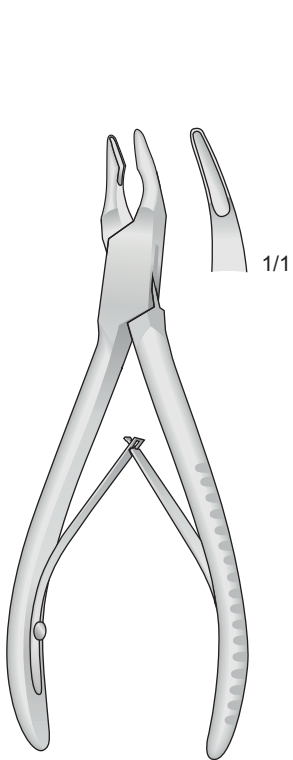
Pinze ossivore

Bone rongeurs

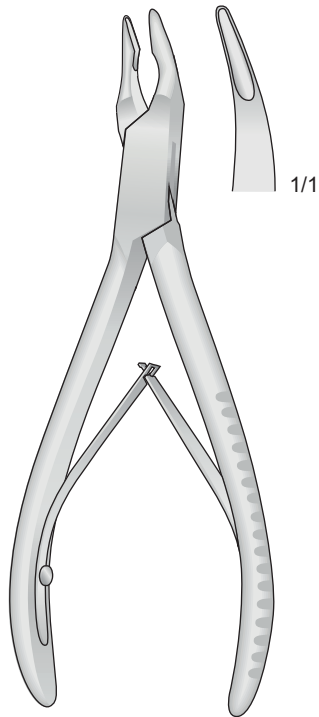
Hohlmeißelzangen

Pinces-gouges

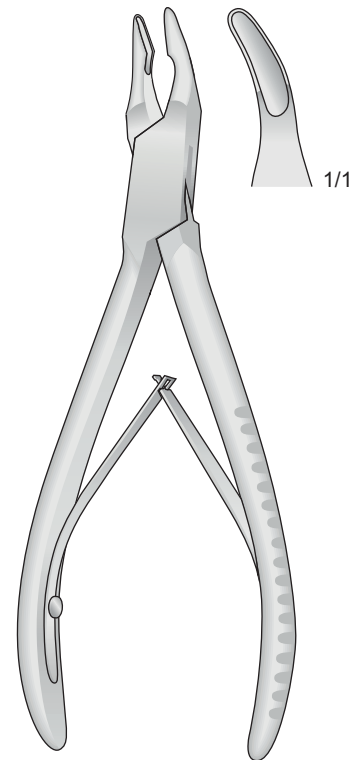
Pinza-gubias



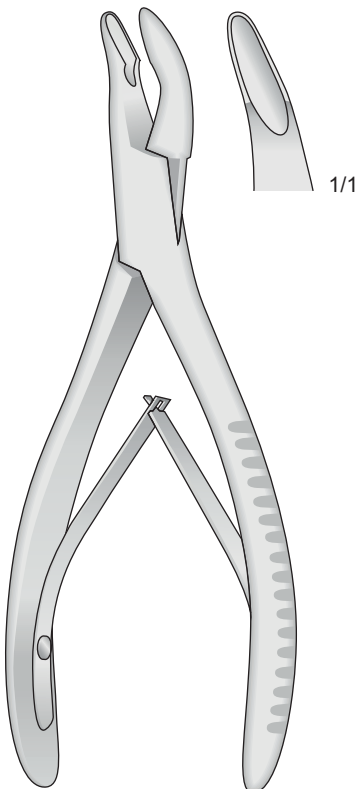
MINI FRIEDMANN  
**FO-15**  
120 mm



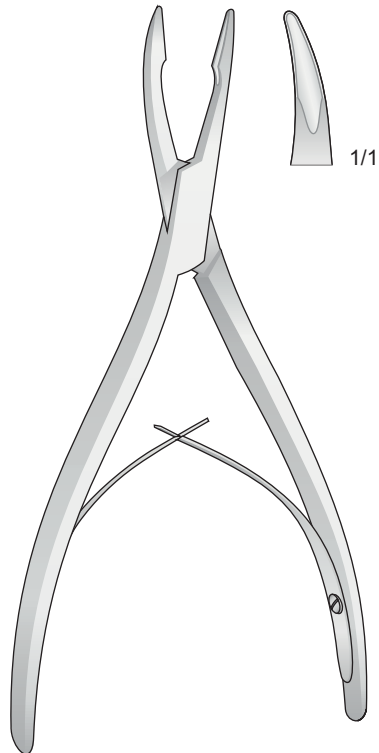
FRIEDMANN  
**FO-17**  
140 mm



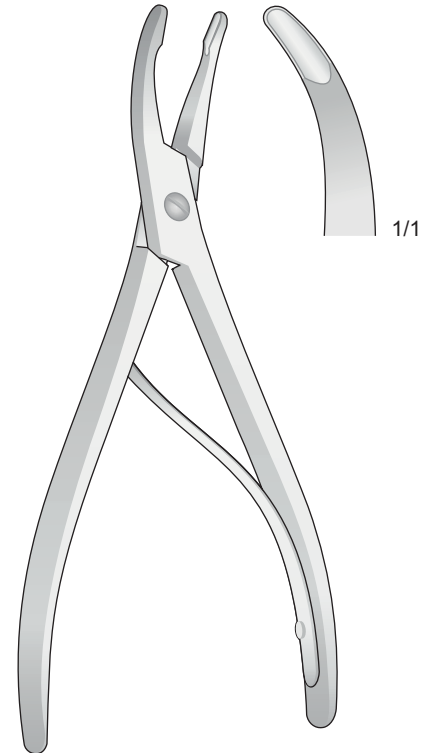
BLUMENTHAL  
**FO-19**  
155 mm



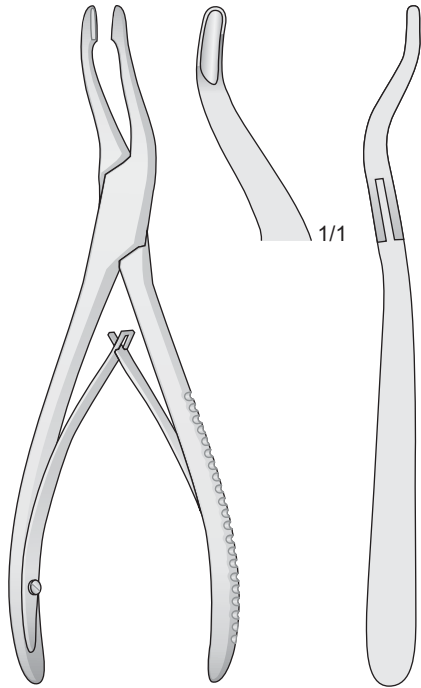
MEAD  
**FO-21**  
165 mm



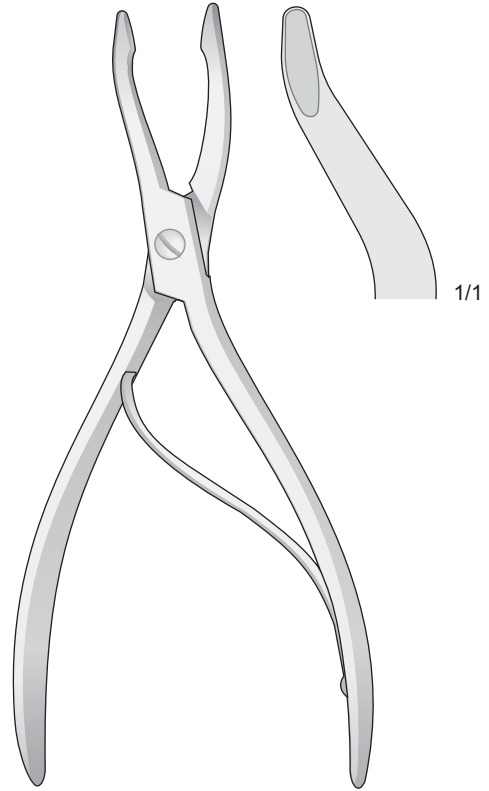
FRIEDMANN  
**FO-16**  
160 mm



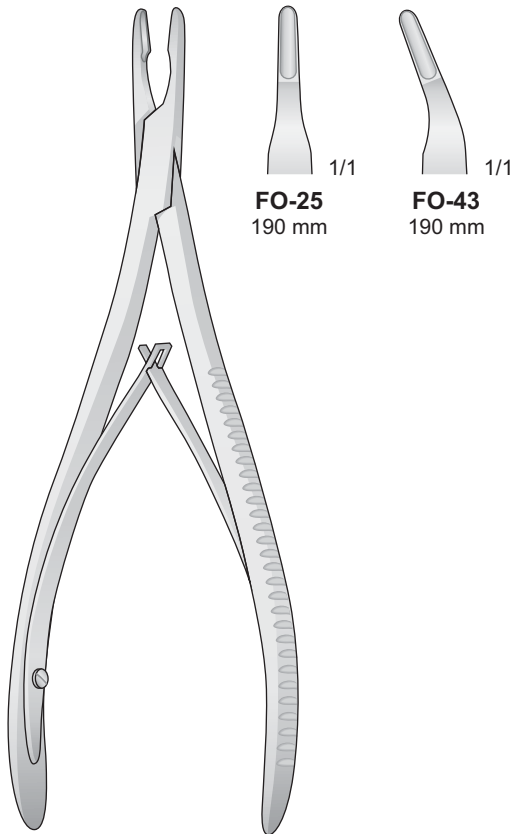
LUER  
**FO-18**  
155 mm



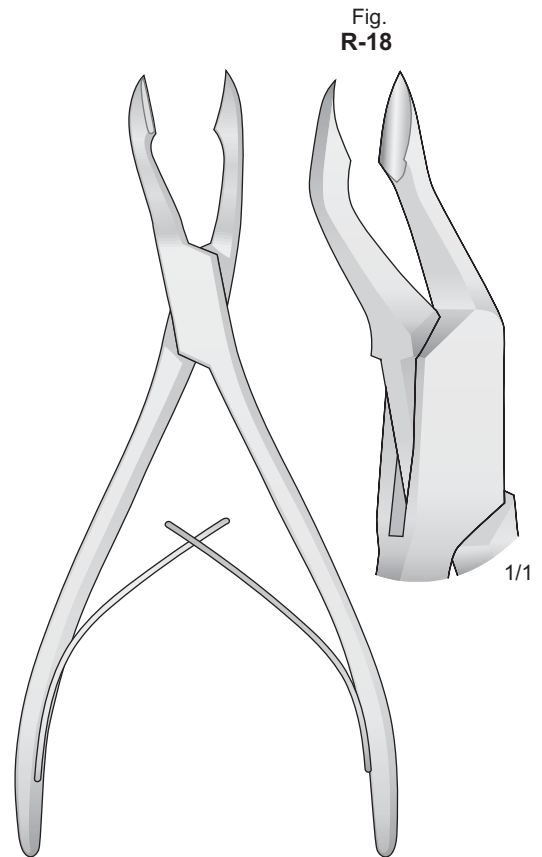
ALEXANDER  
**FO-27**  
140 mm



JANSEN-LEUER  
**FO-10**  
180 mm



LEMPERT  
**FO-25/FO-43**  
190 mm



**FO-33**  
175 mm

Fig.  
**R-18**



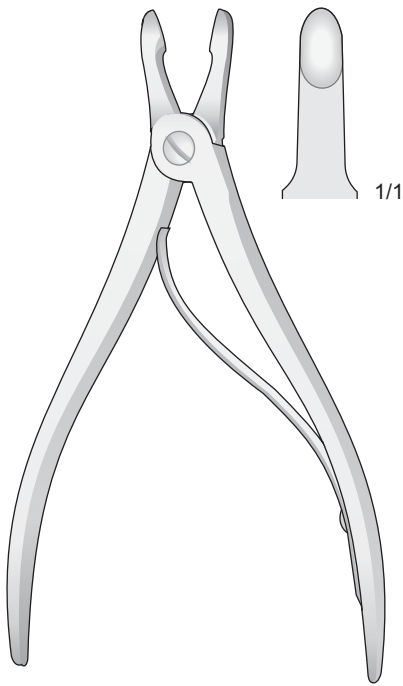
Pinze ossivore

Bone rongeurs

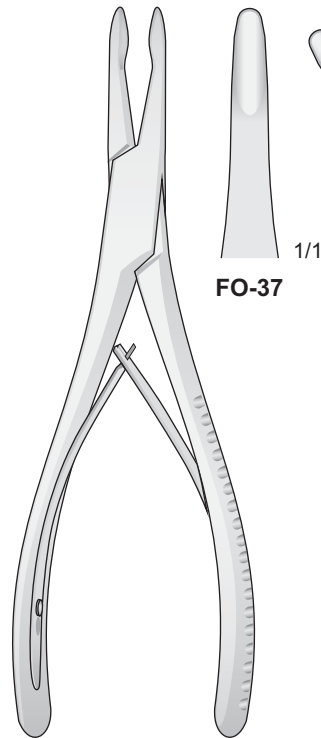
Hohlmeißelzangen

Pinces-gouges

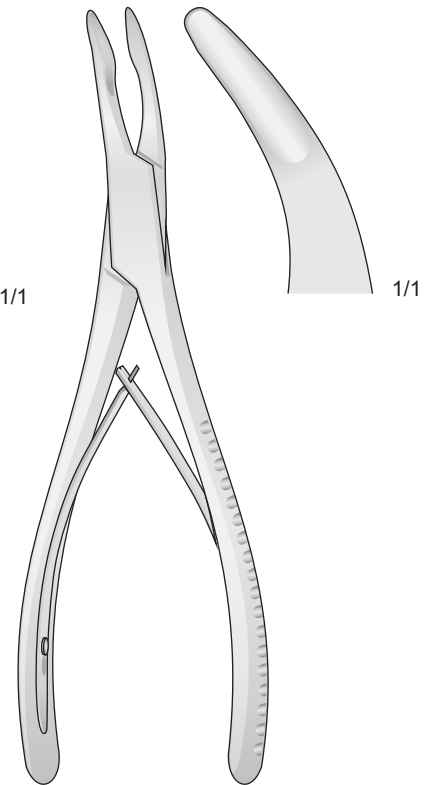
Pinza-gubias



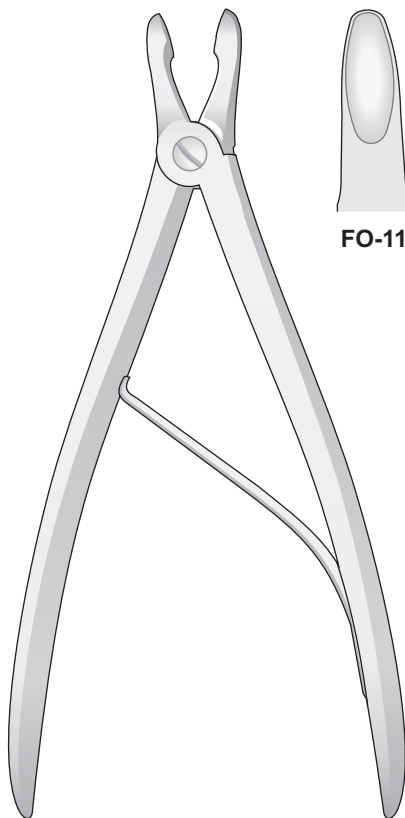
HARTMANN  
FO-14  
155 mm



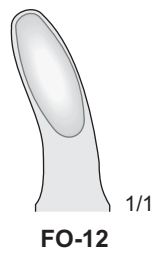
JANSEN  
FO-37/FO-39  
170 mm



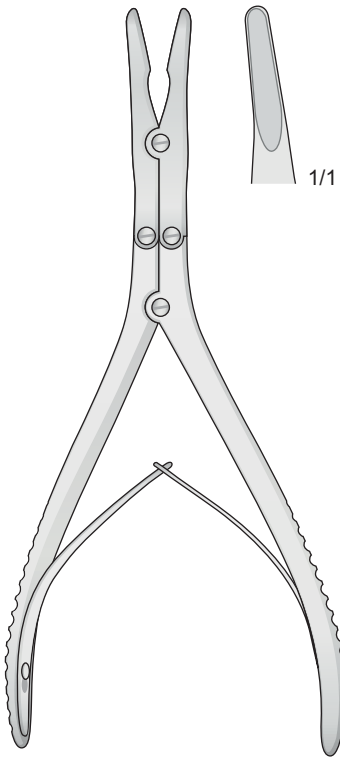
OLIVECRONA  
FO-45  
190 mm



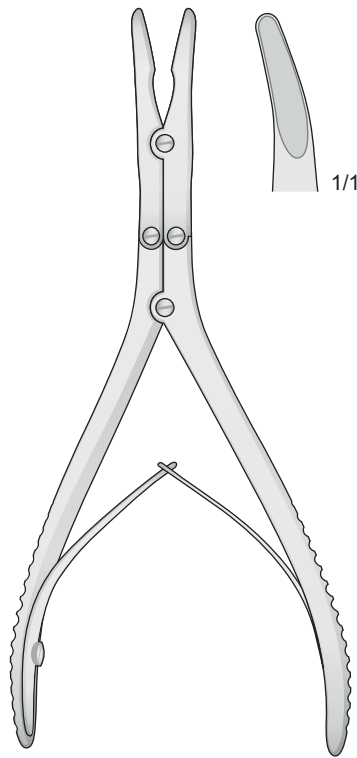
CUSHING  
FO-11/FO-12  
190 mm



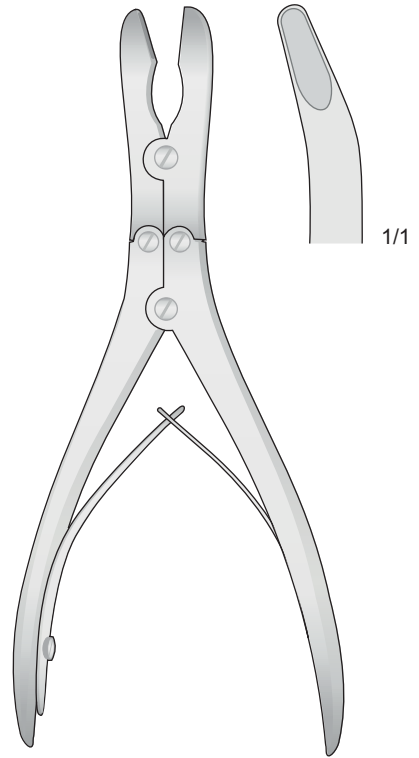
LUER-STILLE  
FO-13  
185 mm



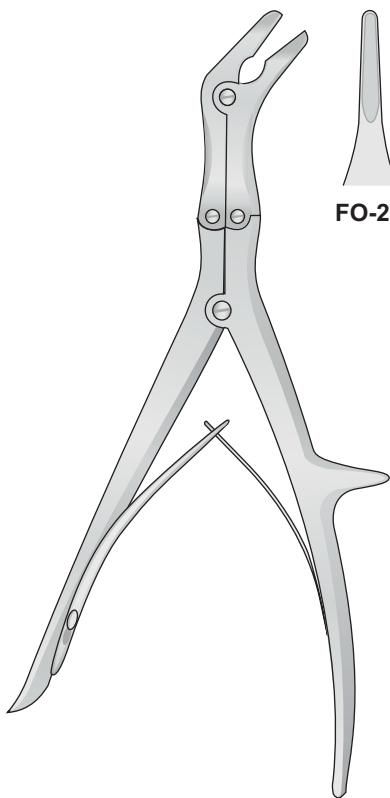
BEYER  
FO-20  
180 mm



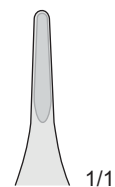
ZAUFAL-JANSEN  
FO-34  
180 mm



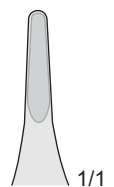
RUSKIN-STILLE  
FO-35  
180 mm



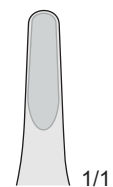
ECHLIN  
FO-28/FO-30  
230 mm



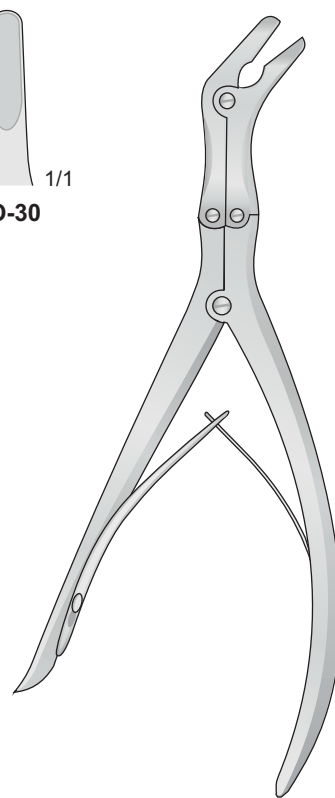
FO-28



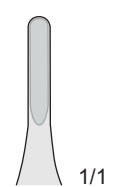
FO-29



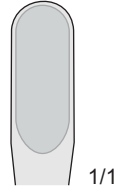
FO-30



LEKSELL  
FO-31/FO-32

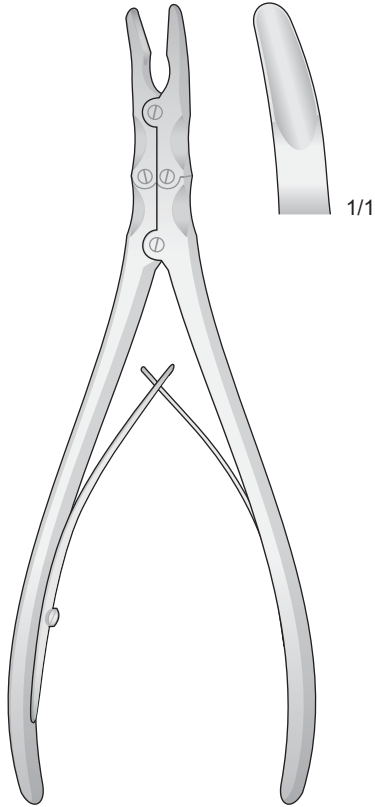


FO-31  
240 mm

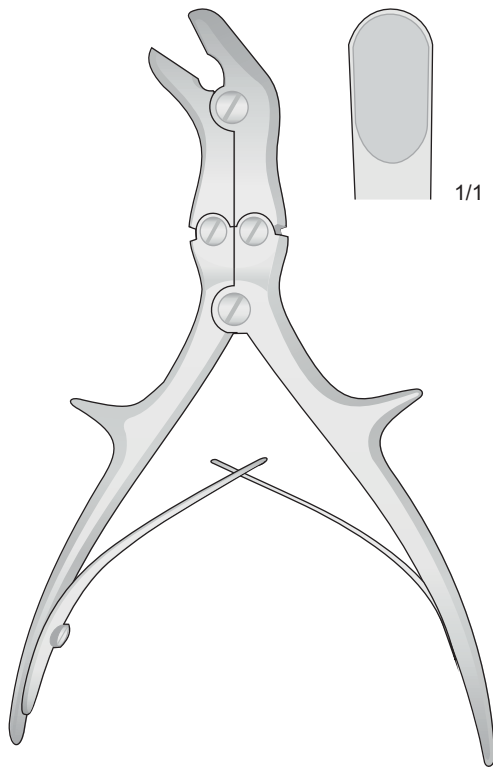


FO-32  
250 mm

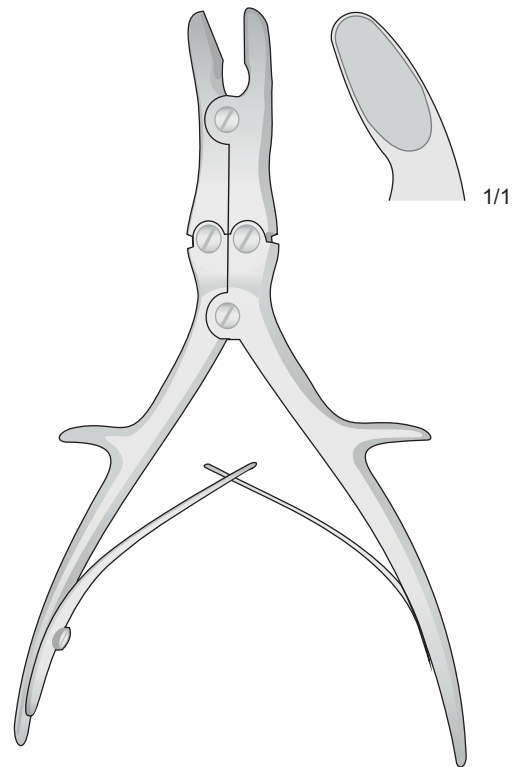




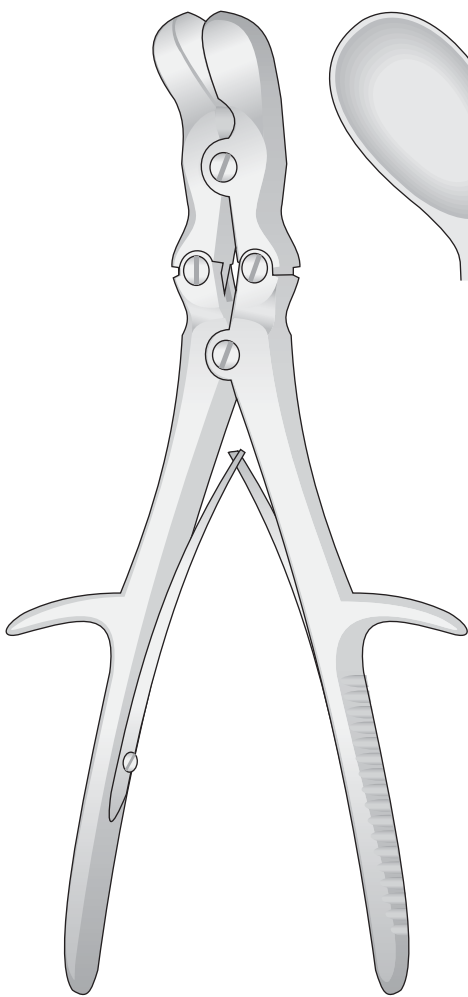
RÖTTGEN-RUSKIN  
**FO-199**  
240 mm



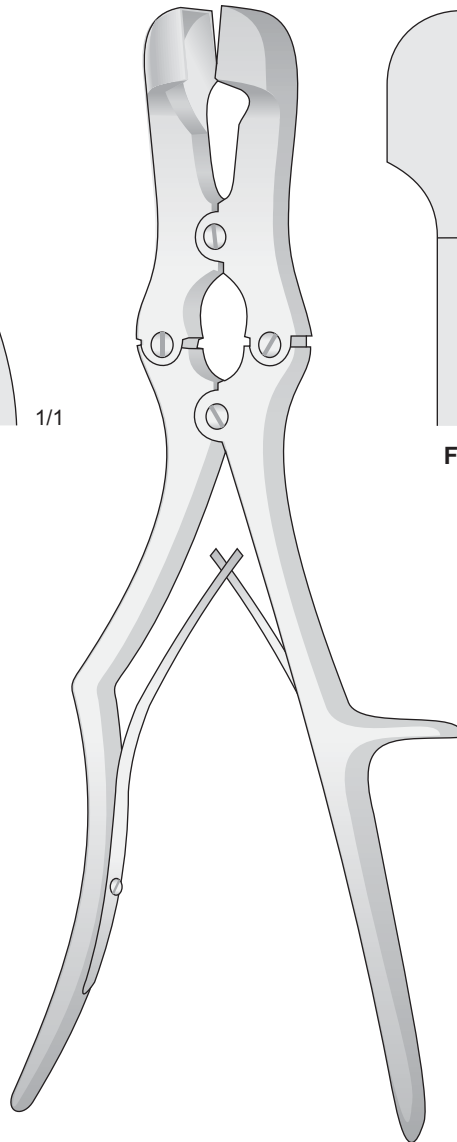
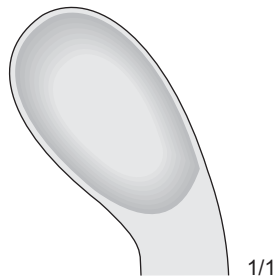
STILLE  
**FO-36**  
210 mm



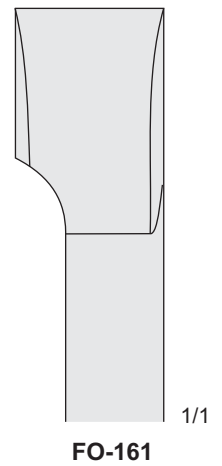
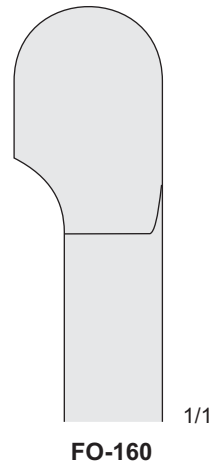
LUER-STILLE  
**FO-38**  
210 mm

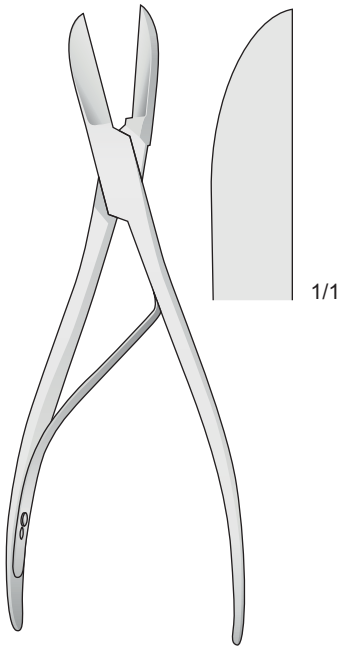


LUER-STILLE  
**FO-200**  
260 mm

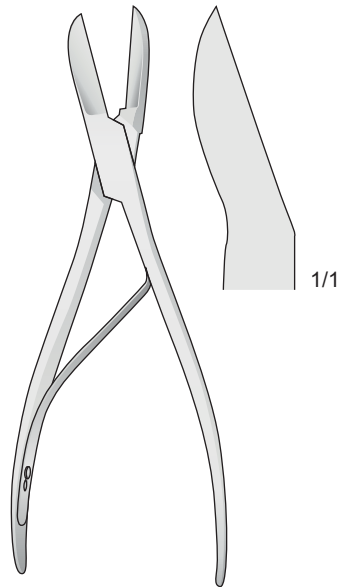


SAUERBRUCH  
**FO-160/FO-161**  
300 mm

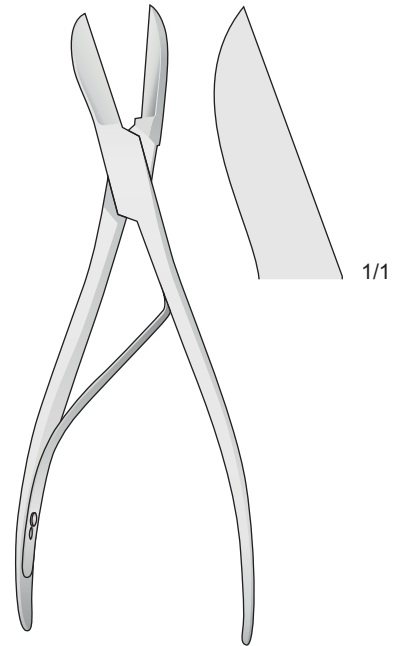




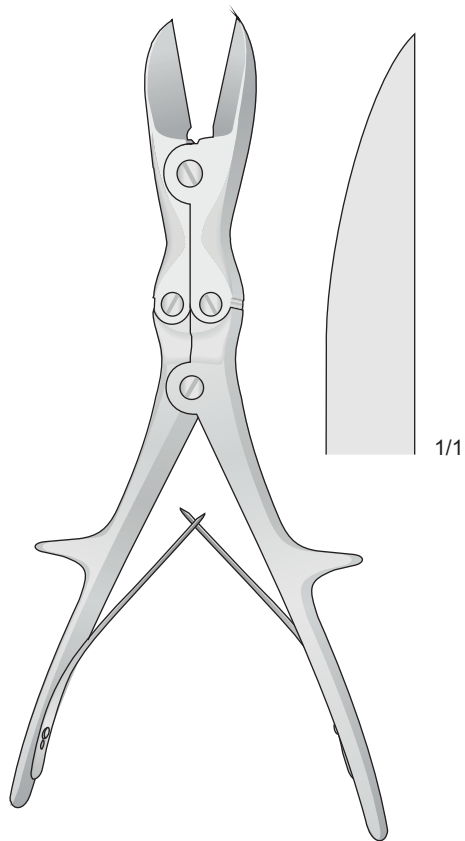
LISTON  
**LX-108**  
220 mm



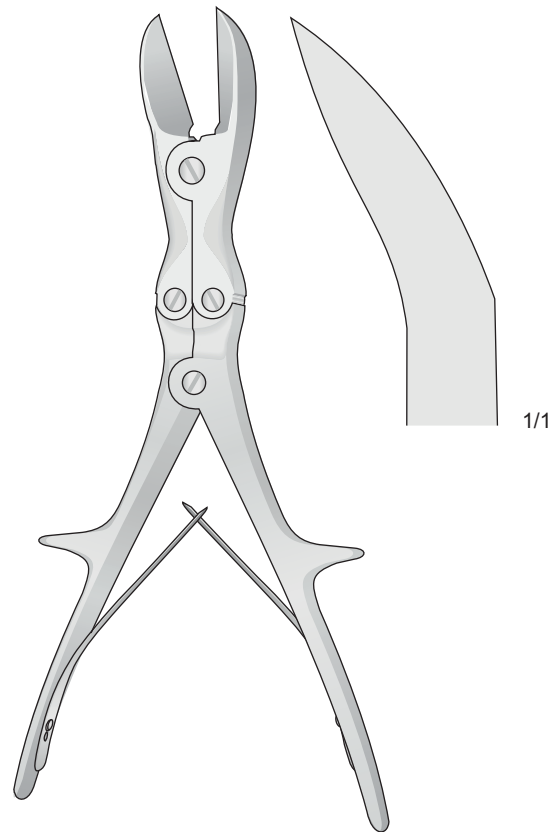
LISTON  
**LX-109**  
170 mm



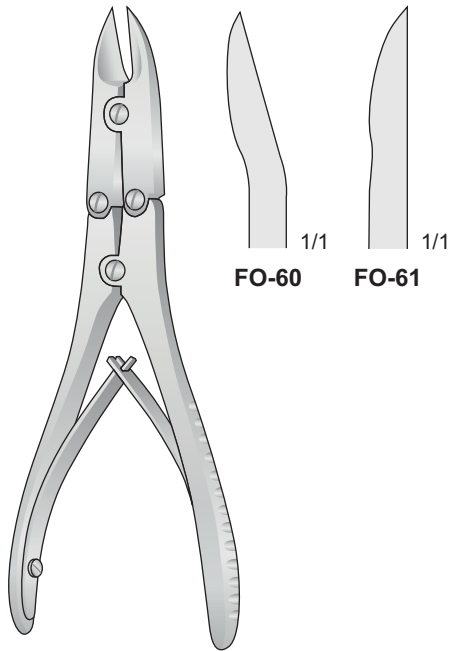
LISTON  
**LX-110**  
220 mm



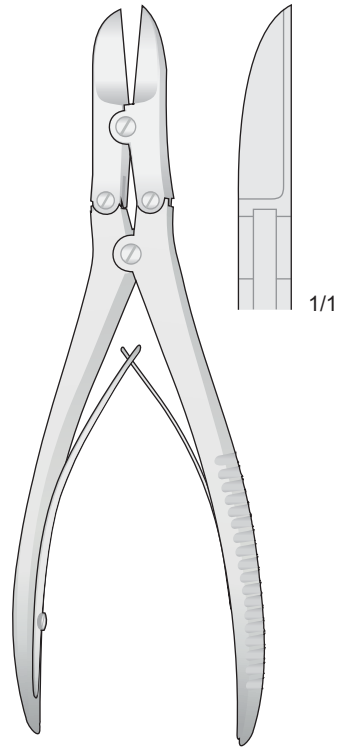
LISTON  
**FO-41**  
270 mm



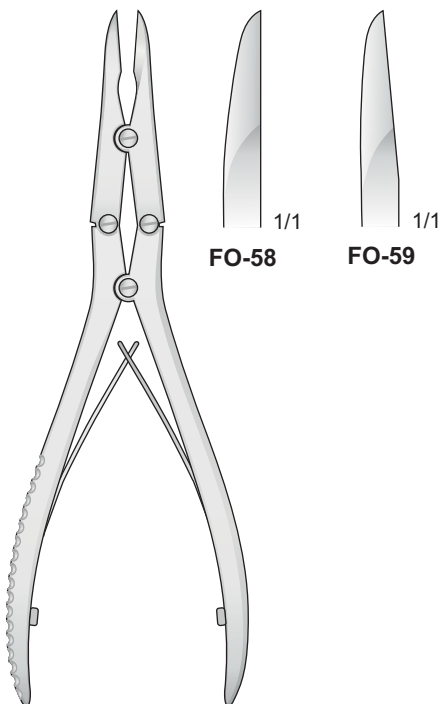
LISTON  
**FO-42**  
270 mm



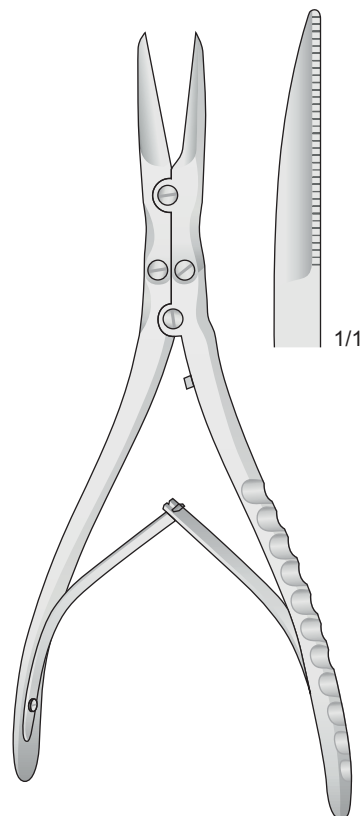
**BÖHLER**  
**FO-60/FO-61**  
150 mm



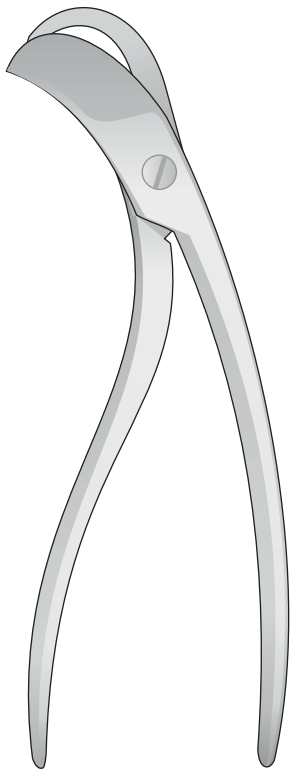
**RUSKIN-LISTON**  
**FO-108**  
190 mm



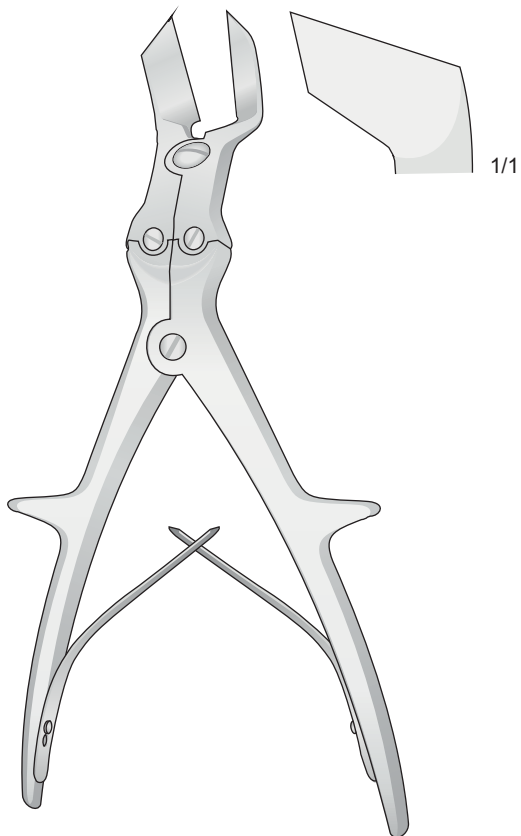
**FO-58/FO-59**  
180 mm



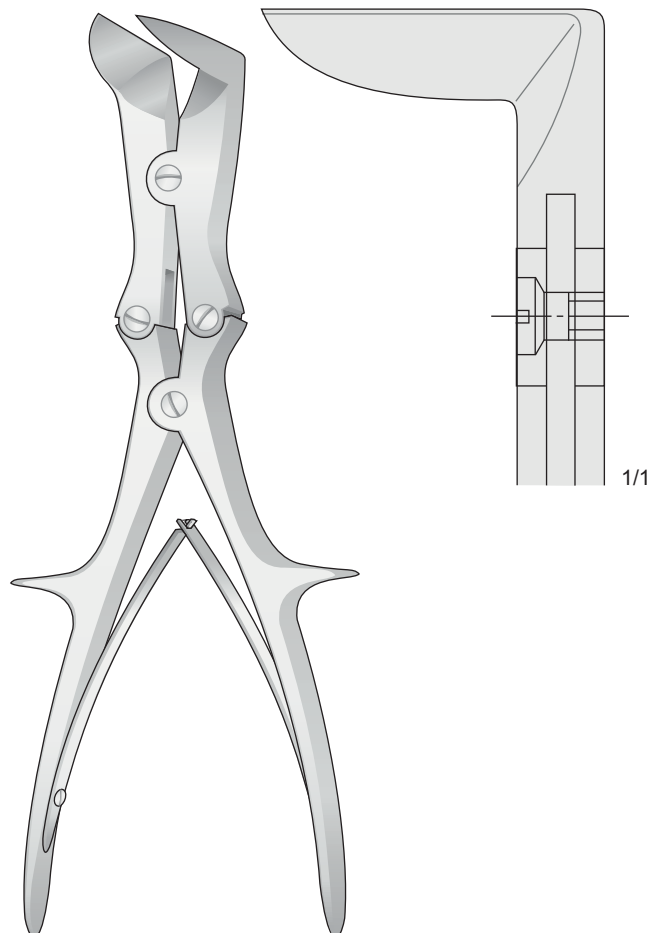
**FO-146**  
215 mm



COLLIN  
LX-112  
195 mm



KEY-HORSLEY  
FO-40  
235 mm



LISTON-STILLE  
FO-158  
265 mm



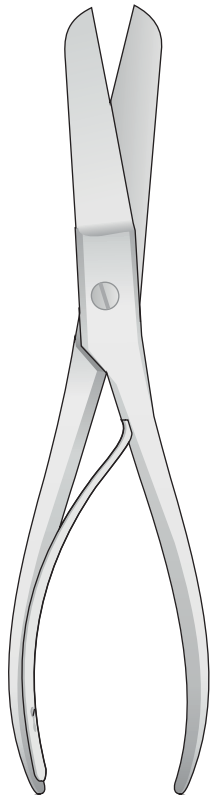
Forbici ossivore

Bone cutting scissors

Knochensplitterscheren

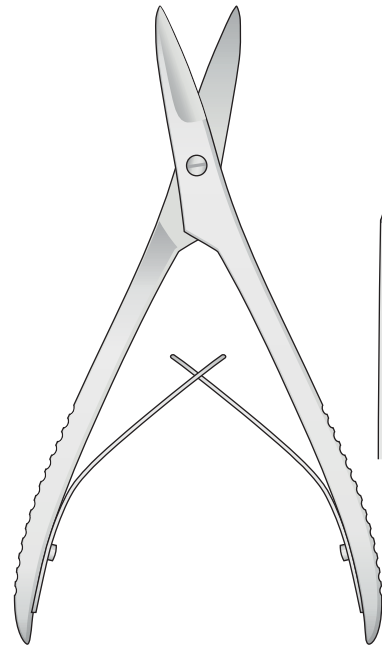
Ciseaux à os

Tijeras para huesos



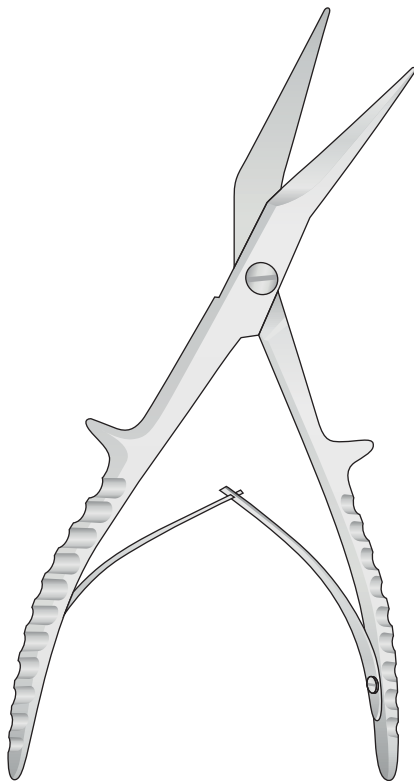
1/1

**FG-40**  
230 mm

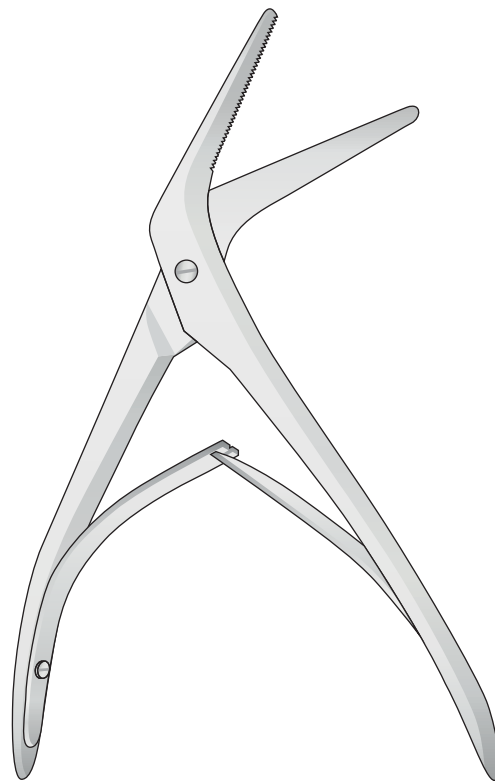


1/1

**FO-63**  
160 mm



**FG-110**  
195 mm



**JACKSON-TESSIER**  
**FG-111**  
190 mm



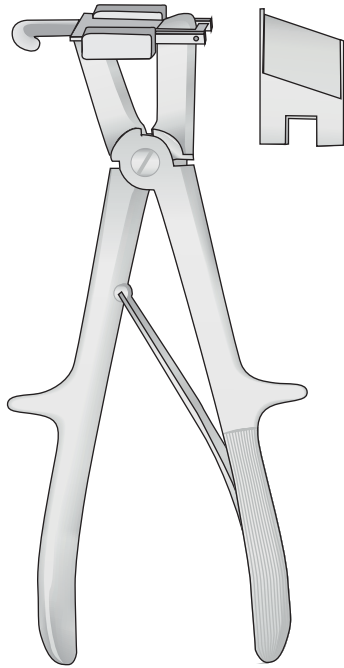
Costotomi, forbici  
per sterno

Rib shears  
Sternum Scissors

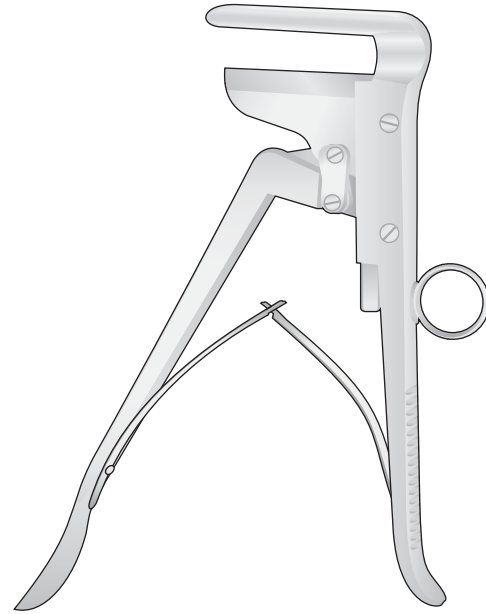
Rippenscheren,  
Sternumscheren

Costotomes et  
ciseau-burins à sternum

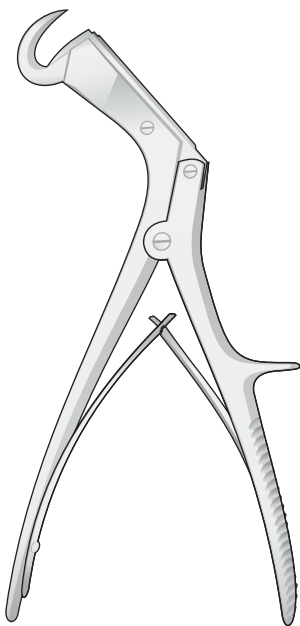
Costotómos  
Tijeras de esternón



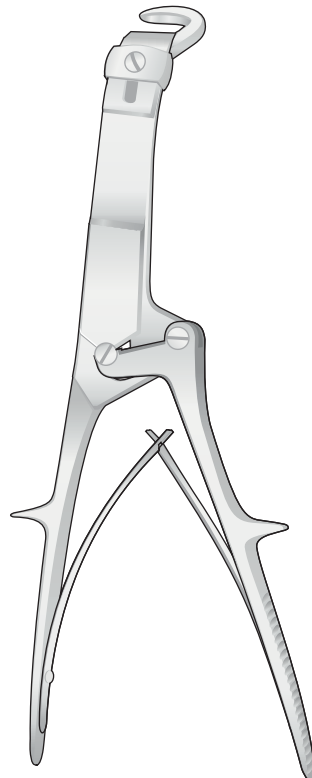
SAUERBRUCH  
LX-164 - 230 mm  
LX-165 - 260 mm



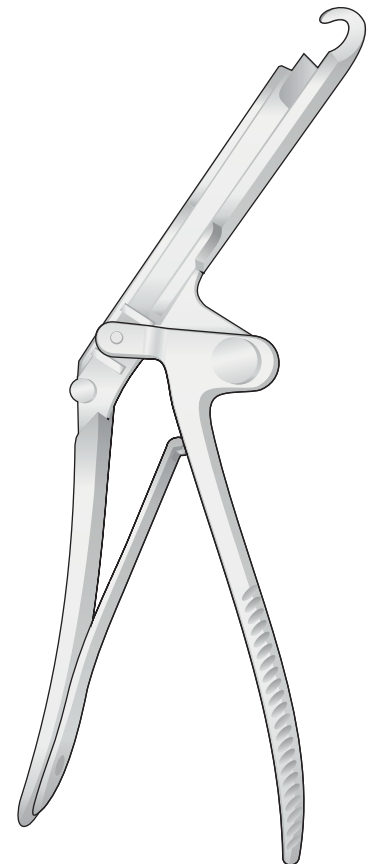
SCHUMACHER  
LX-166  
210 mm



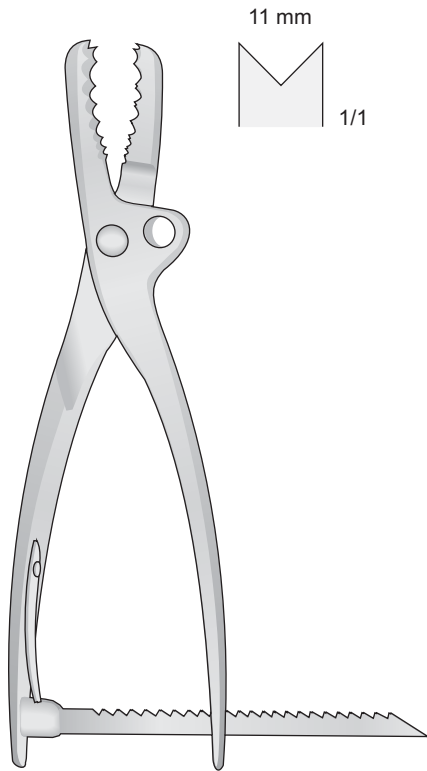
GIERTZ-STILLE  
LX-160  
250 mm



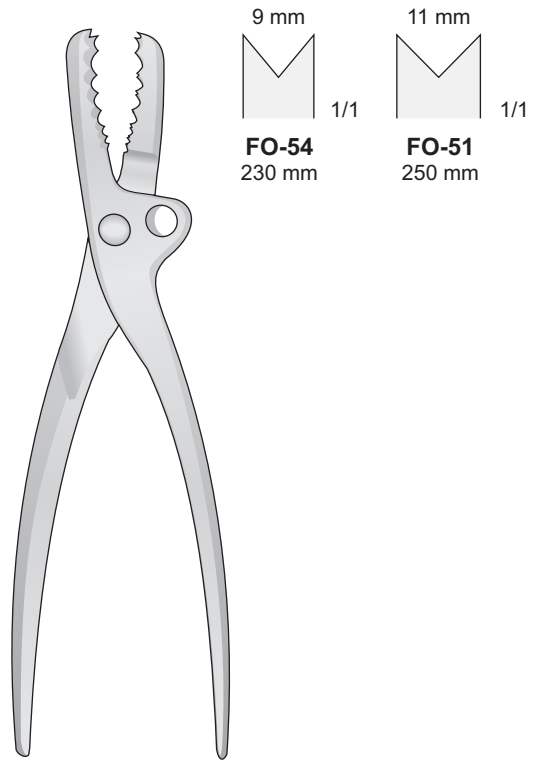
BRUNNER  
LX-161 - Destro  
LX-163 - Sinistro  
320 mm



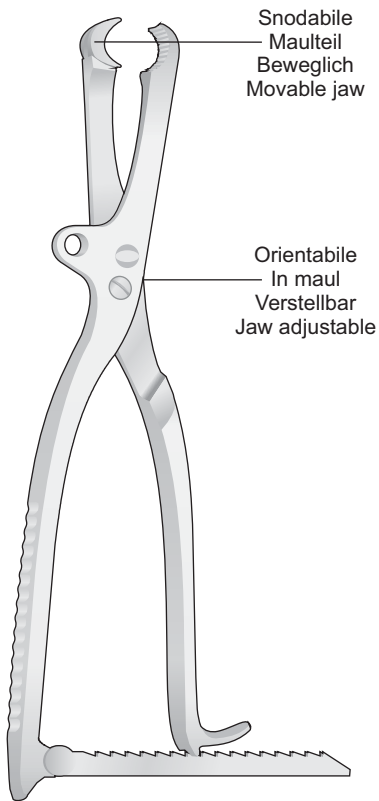
SAUERBRUCH-FREY  
LX-162  
370 mm



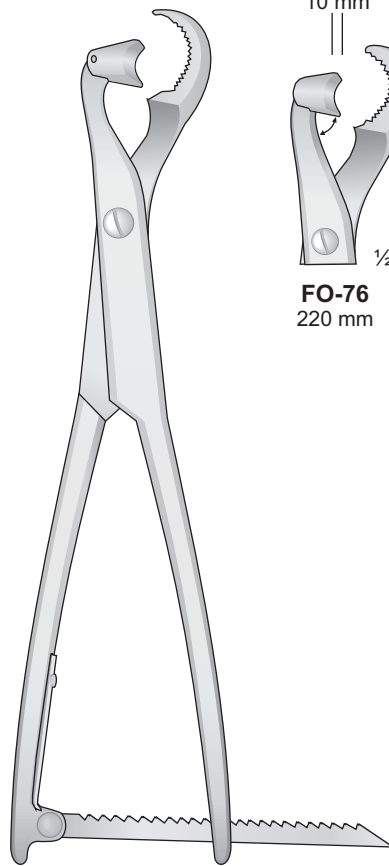
FARABEU-F-LAMBOTTE  
**FO-52**  
250 mm



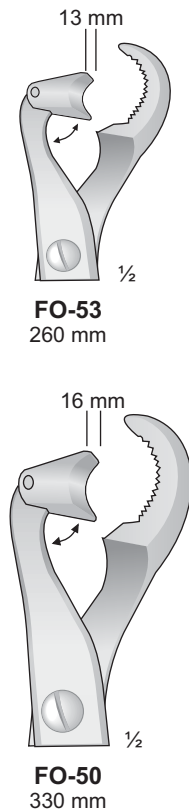
FARABEU  
**FO-51/FO-54**



LAMBOTTE  
**FO-44**  
265 mm

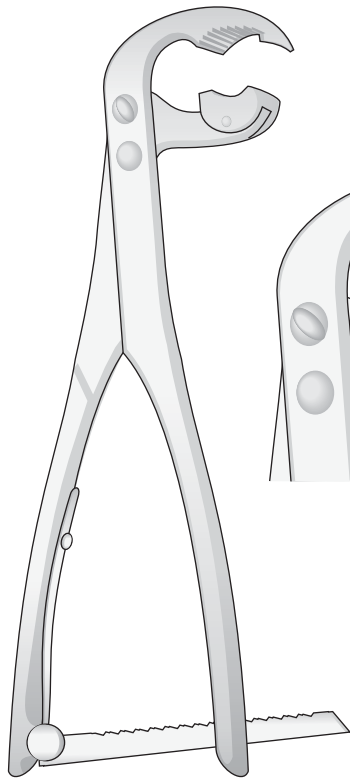


LAMBOTTE  
**FO-50/FO-76**

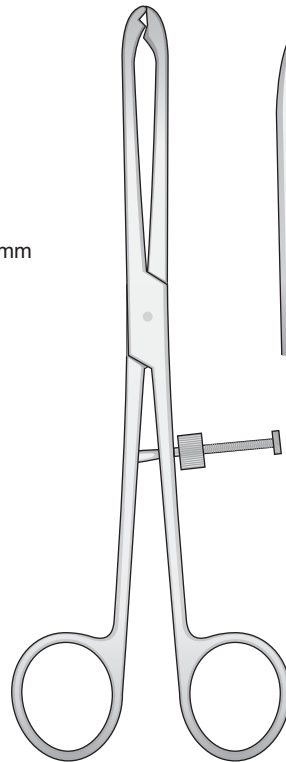
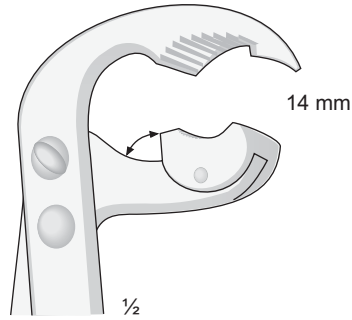


**FO-50**  
330 mm

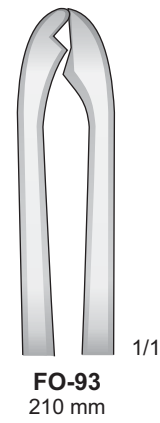




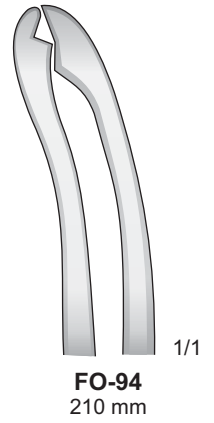
**FO-78**  
215 mm



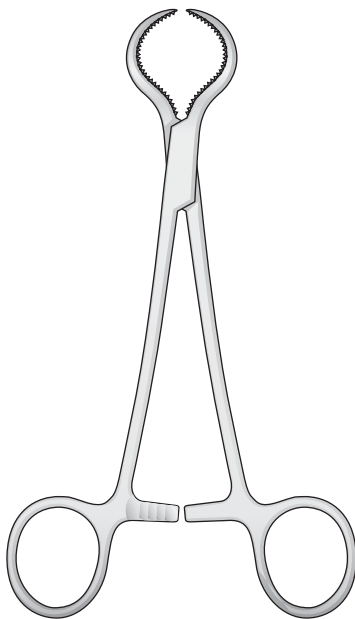
FIBULA  
**FO-93/FO-94**  
210 mm



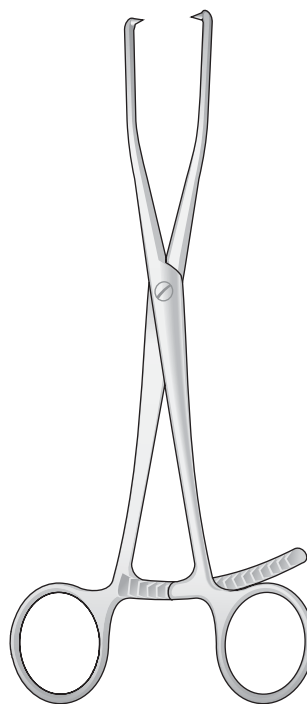
**FO-93**  
210 mm



**FO-94**  
210 mm



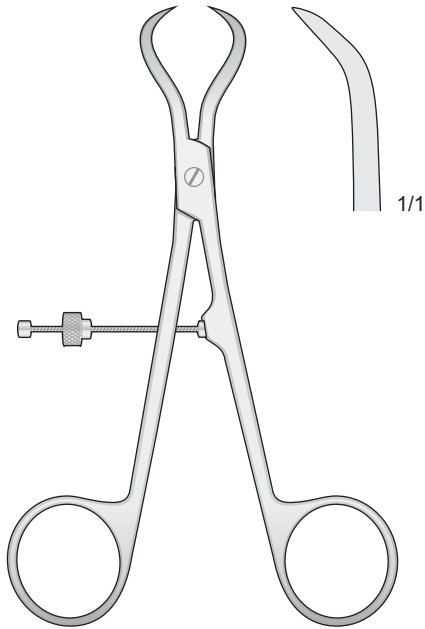
LEWIN  
**FO-69**  
180 mm



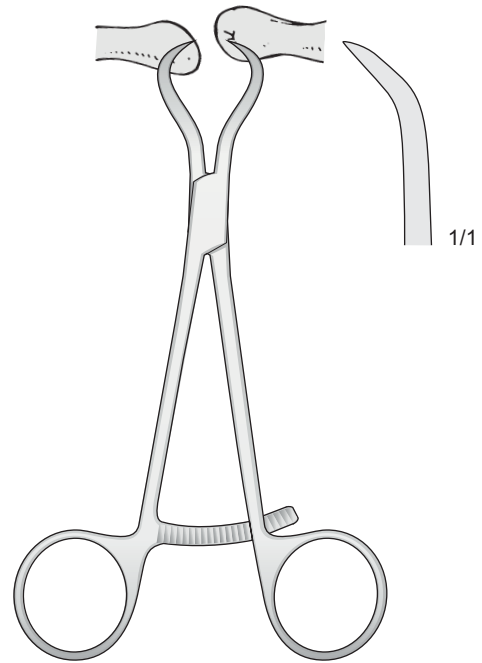
**FO-67**  
210 mm



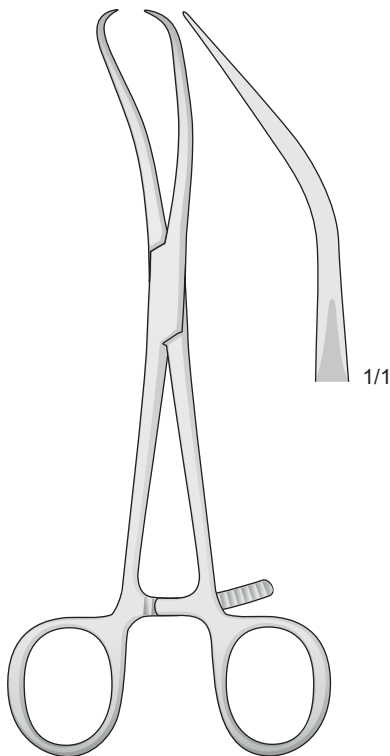
Pinze riposizionatrici di osso - Repositionszangen  
Reposition forceps - Pinzas para la reducci3n de huesos



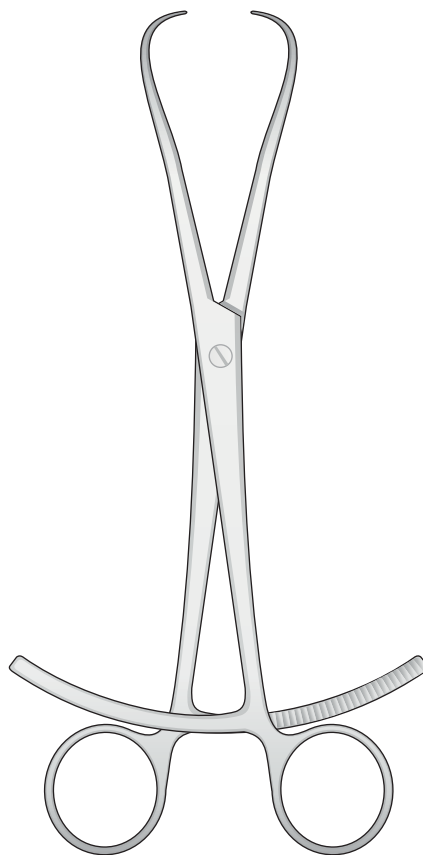
**FO-79**  
140 mm



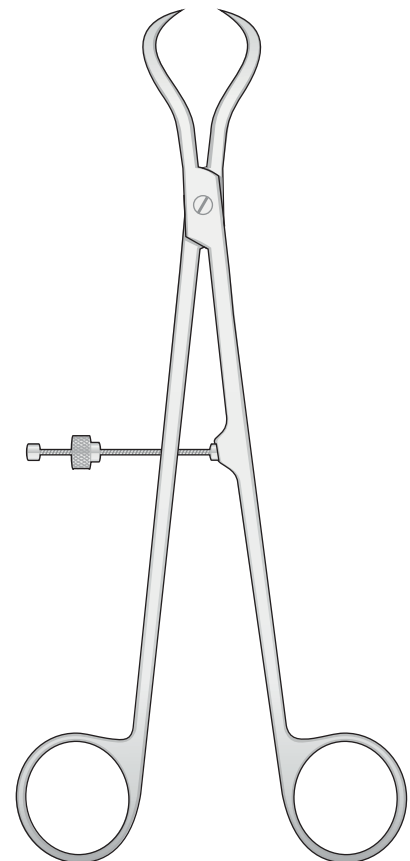
**FO-66**  
135 mm



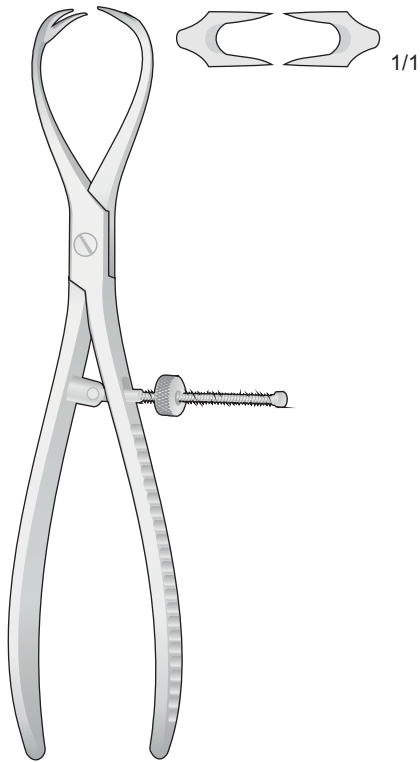
**REILL**  
**FO-64**  
170 mm



**FO-68**  
200 mm



**FO-81**  
210 mm

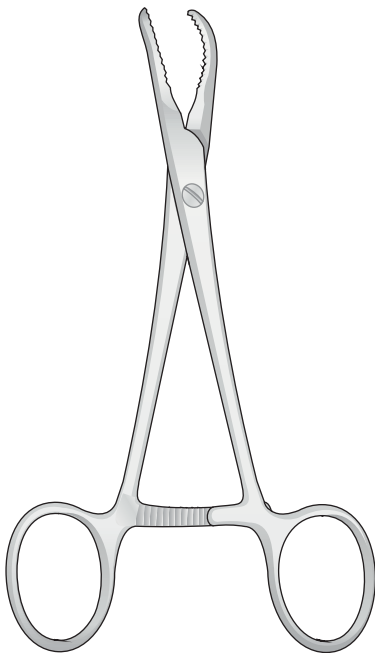


**PATELLA  
FO-46**  
185 mm

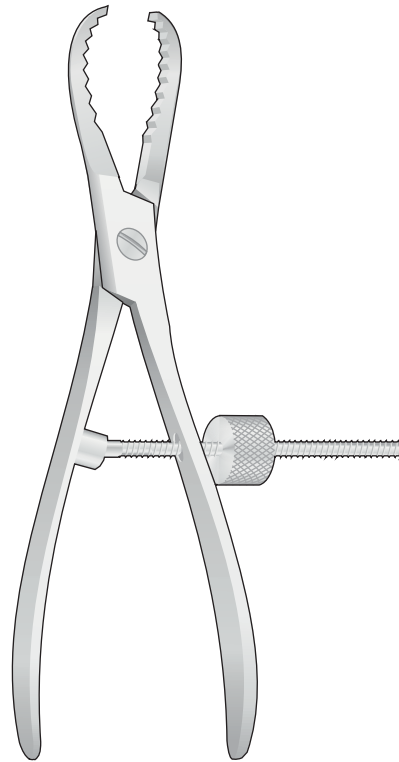
Pinza con regolazione  
Forceps with thread fixation  
Zange mit Gewindsperr  
Davier avec système d'arrêt fileté

Pinza con cremagliera  
Forceps with ratchet fixation  
Zange mit Zahnsperre  
Davier à crémaillère

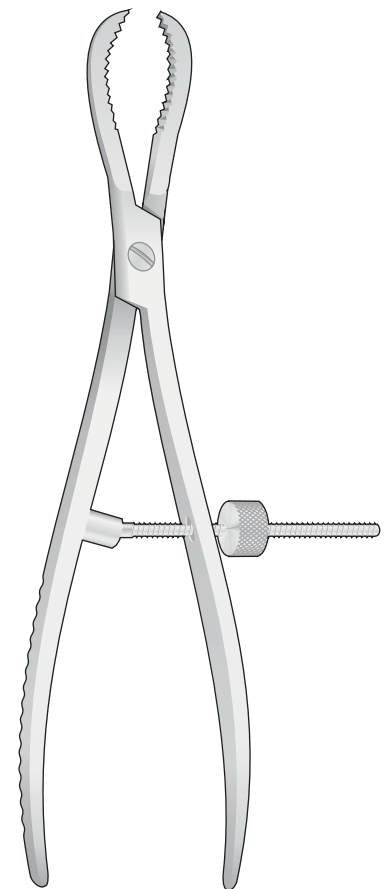
Pinza con regolazione  
Forceps with thread fixation  
Zange mit Gewindsperr  
Davier avec système d'arrêt fileté



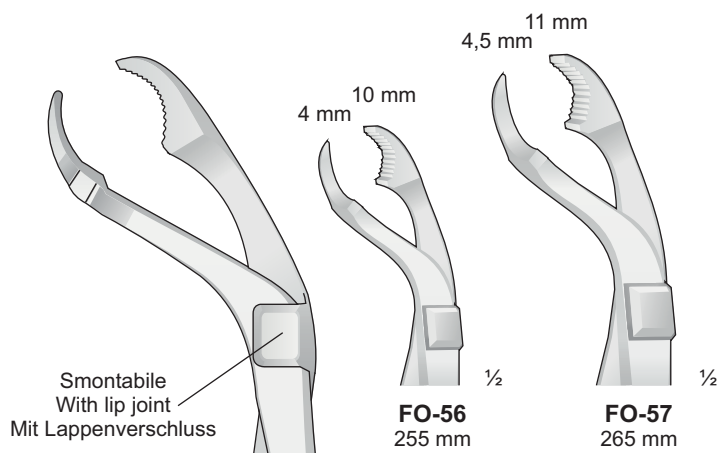
**FO-47**  
140 mm



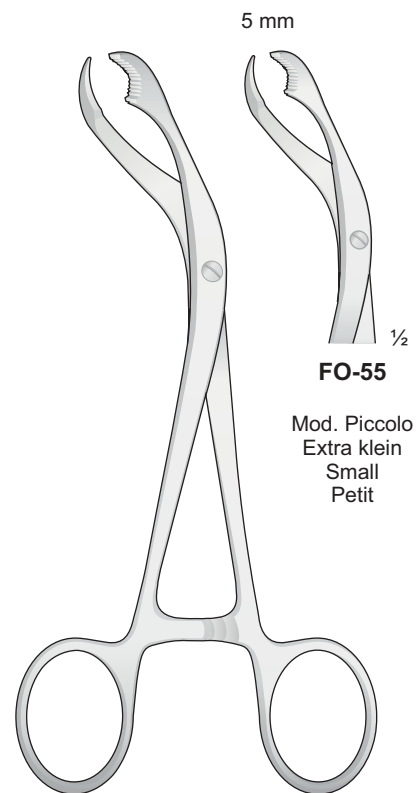
**FO-48**  
170 mm



**FO-49**  
235 mm



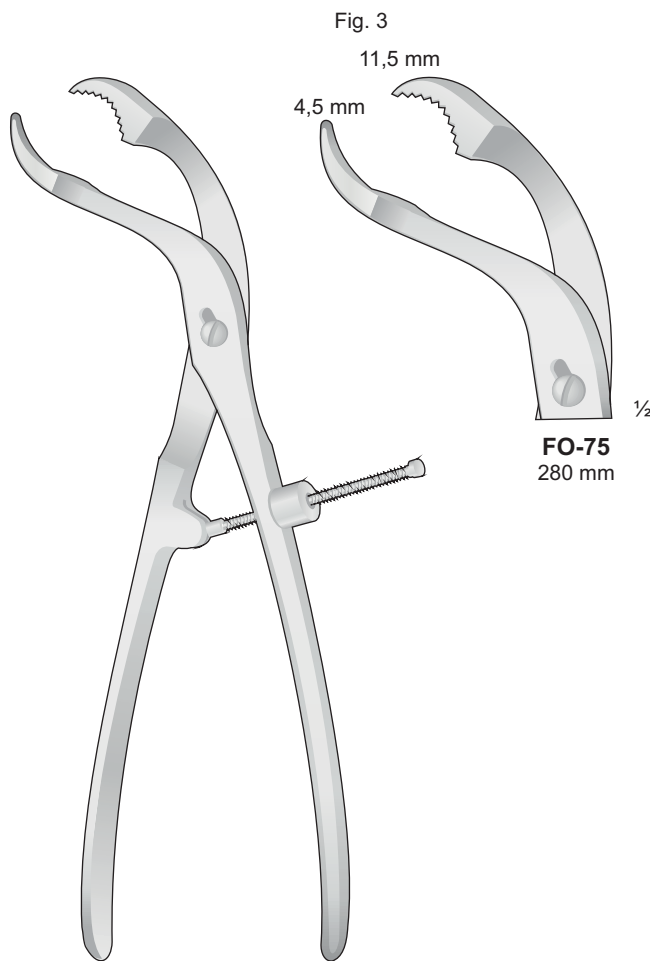
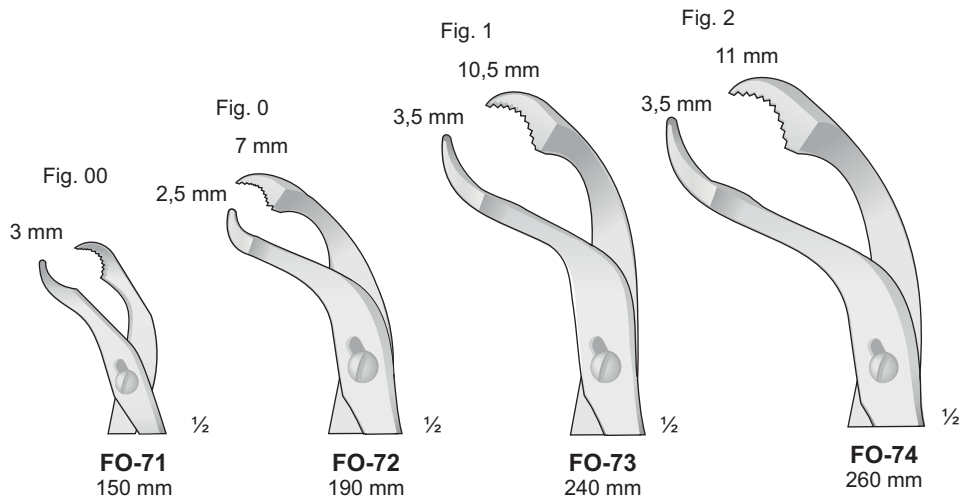
VERBRUGGE  
FO-56/FO-57



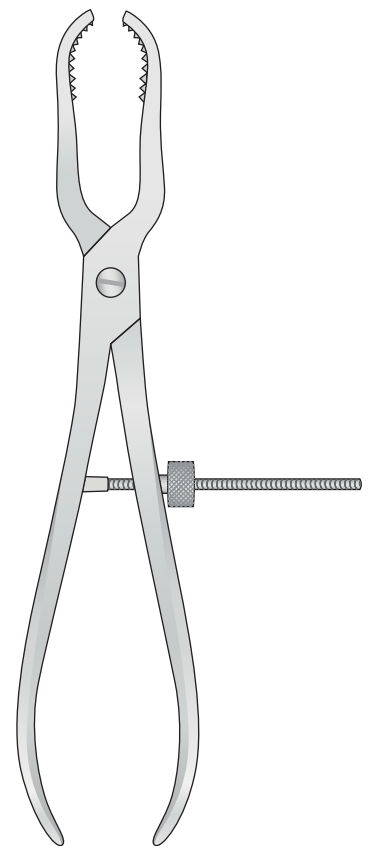
VERBRUGGE  
FO-55  
175 mm



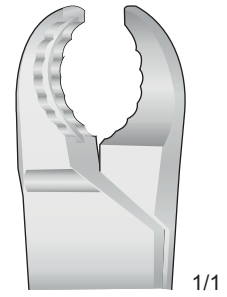
Autocentrante con blocco  
Selbstzentrierend mit Gewindesperre  
Self-centering bone holding forceps with thread lock  
À centrage automatique avec arrêt de filetage



FO-71/FO-75

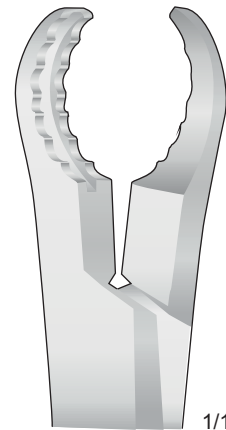


FO-65  
230 mm



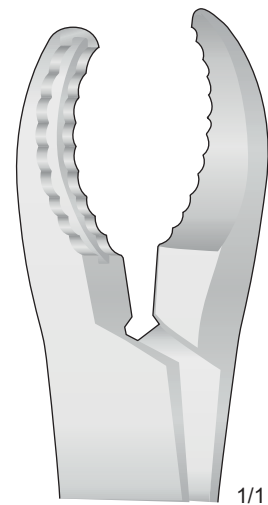
1/1

**FO-62**  
230 mm



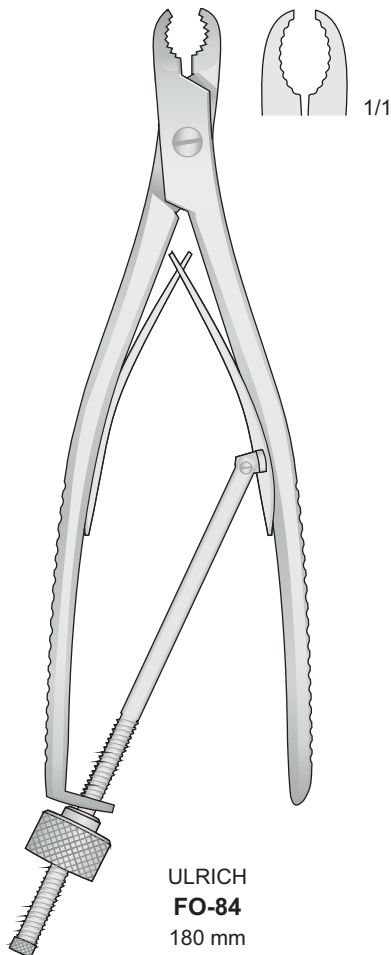
1/1

**FO-82**  
250 mm

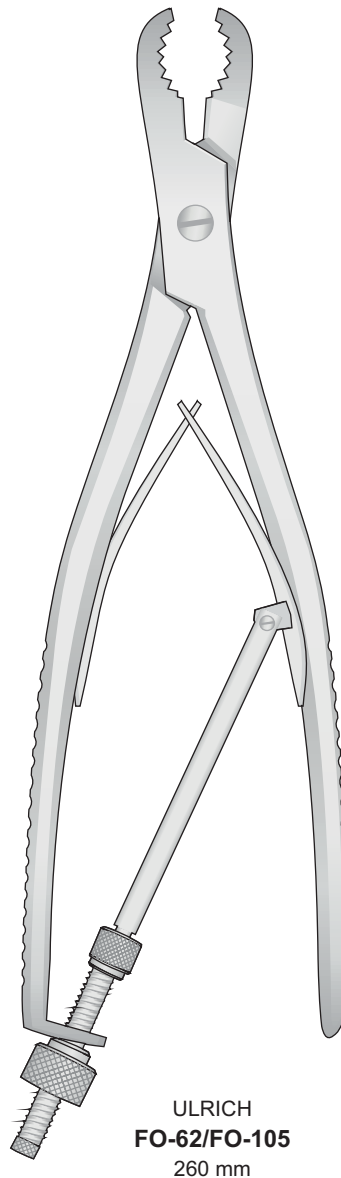


1/1

**FO-105**  
280 mm



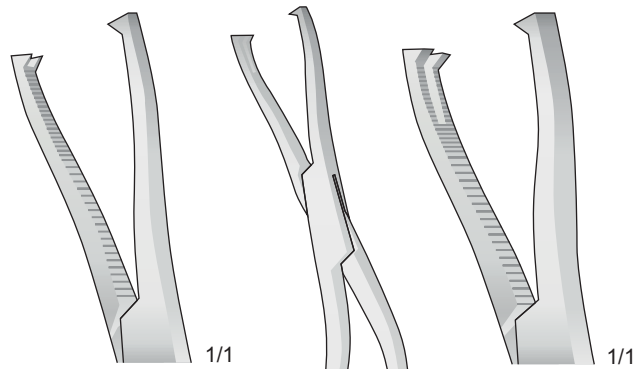
ULRICH  
**FO-84**  
180 mm



ULRICH  
**FO-62/FO-105**  
260 mm

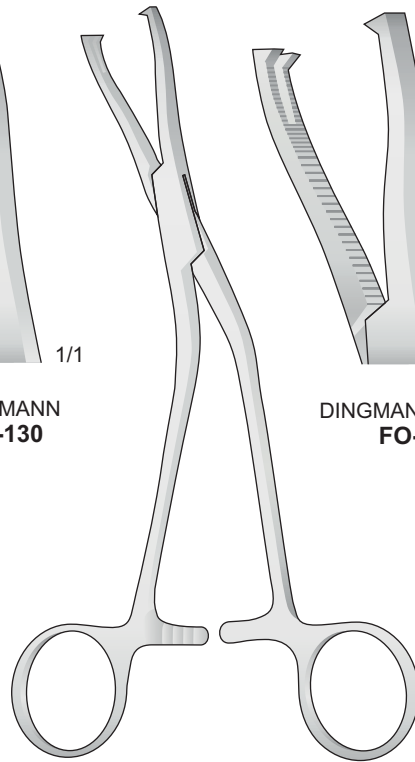


Pinze per menisco e cartilagine - Meniscus and cartilage clamp  
Meniskus und Knorpelfasszangen - Pincers à saisir ménisque et cartilages



DINGMANN  
FO-130

DINGMANN MODIF.  
FO-131

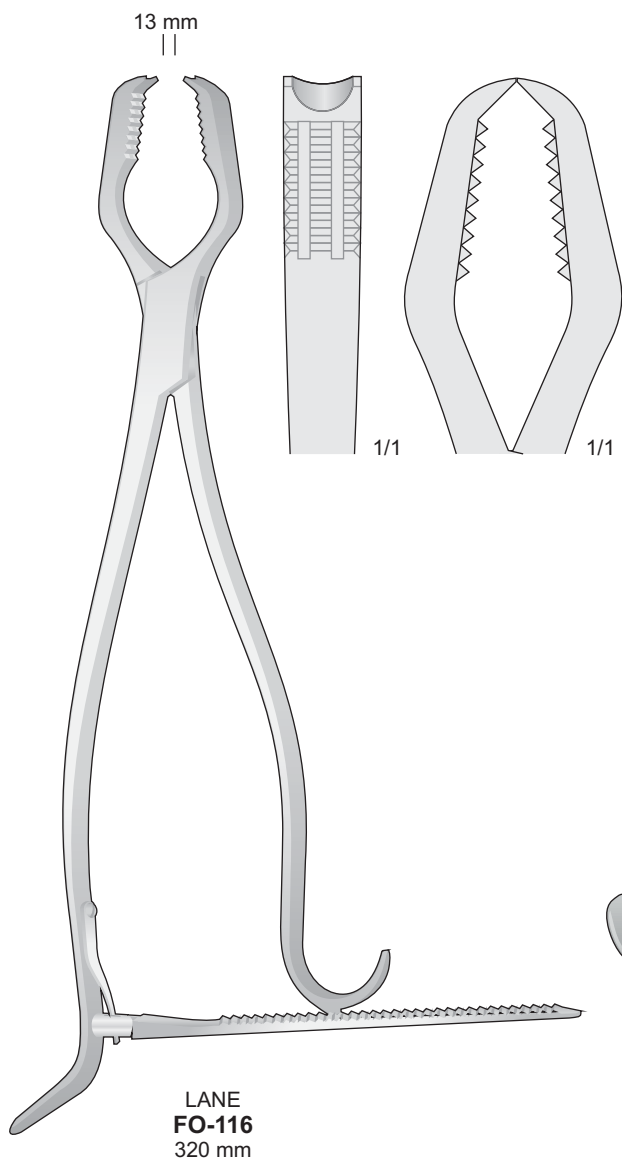


DINGMANN  
FO-130/FO-131  
190 mm

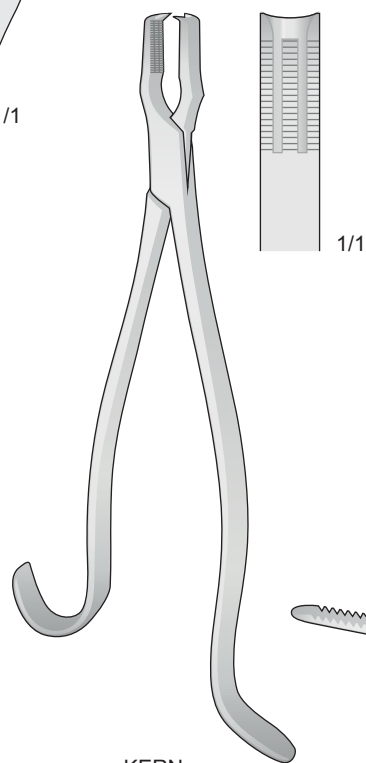


FO-134  
185 mm

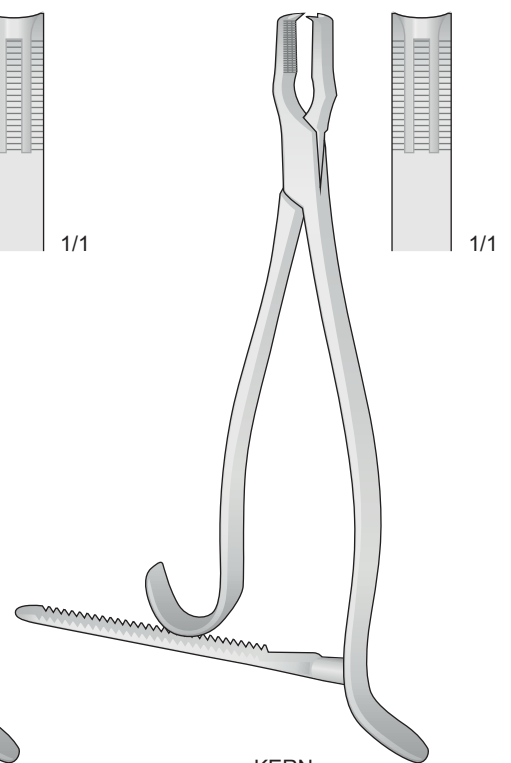
MARTIN  
FO-133  
200 mm



LANE  
**FO-116**  
320 mm

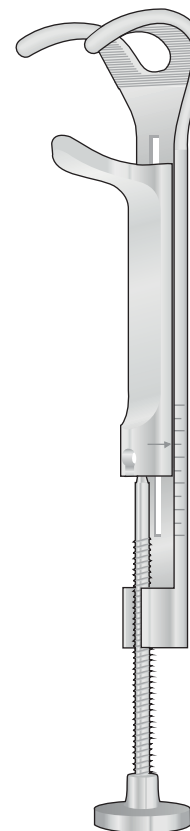
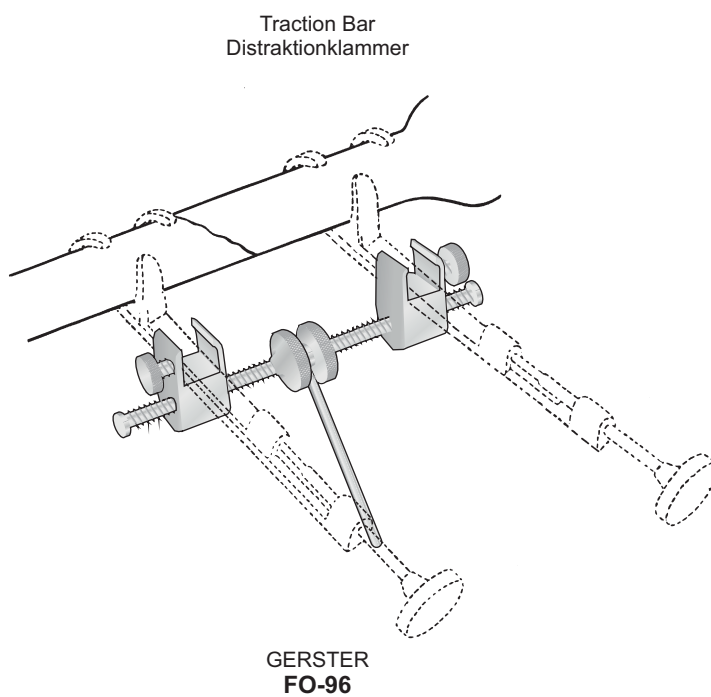


KERN  
**FO-114** 170 mm  
**FO-115** 220 mm



KERN  
**FO-110** 170 mm  
**FO-112** 220 mm

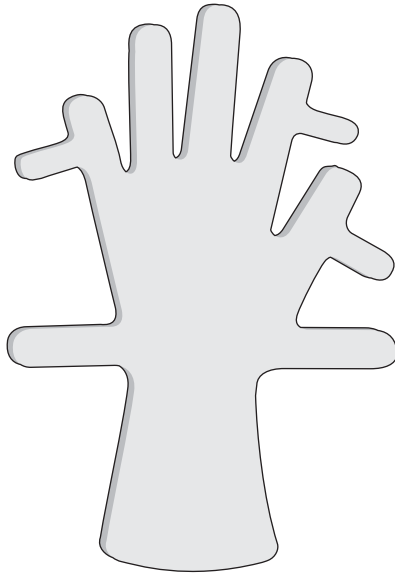




GERSTER-LOWMAN  
FO-90 120 mm  
FO-91 185 mm  
FO-92 200 mm

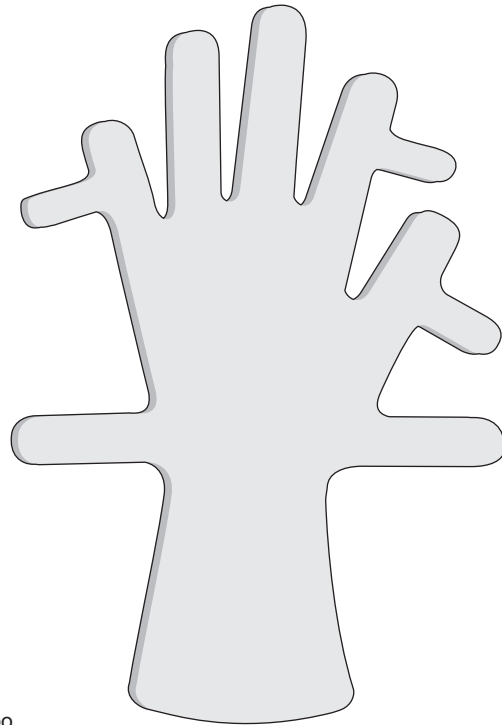


Per bambini  
For children  
Für Kinder  
Pour enfants  
Para niños



**FO-299**

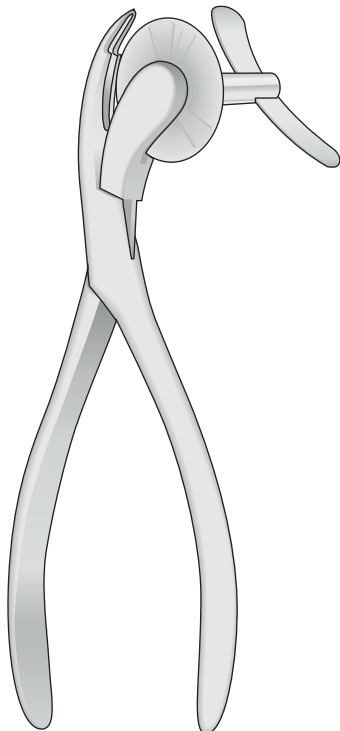
Per adulti - For adults - Für Erwachsene  
Pour adultes - Para adultos



**FO-300**

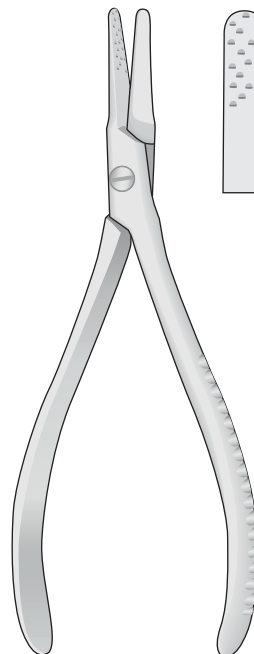
Mani di piombo  
Lead hands  
Bleihände  
Main de plomb  
Manos de plombo

Pinza taglia anelli - Forceps for opening rings  
Fingerringssägen - Scies pour bagues - Sierra para anillos

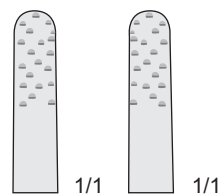


**FO-80**  
170 mm

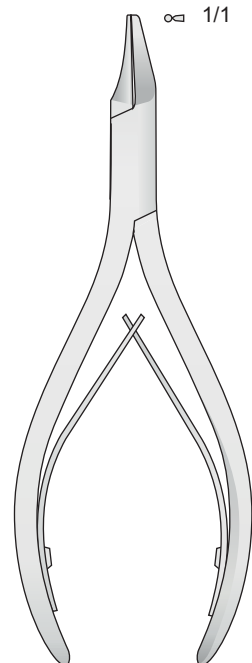
Pinza per estrazione delle unghie  
Nail extracting forceps  
Nagel -Ausreisszange  
Pince pour extraire les ongles  
Pinzas para arrancar uñas



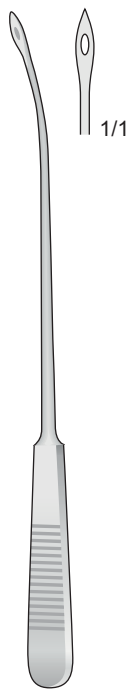
**RADOLF  
FO-159**  
135 mm



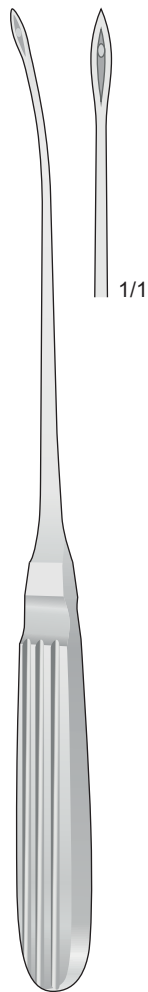
Pinza per unghie  
Nail nipper  
Nagelspaltzange  
Pince à ongles  
Pinzas corta uñas



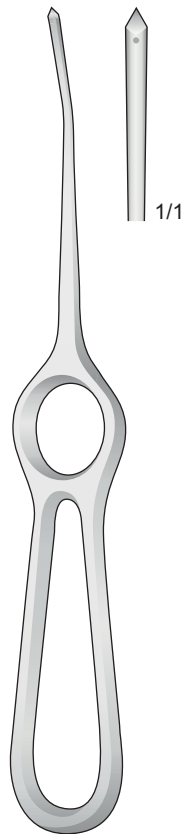
**DP-09**  
135 mm



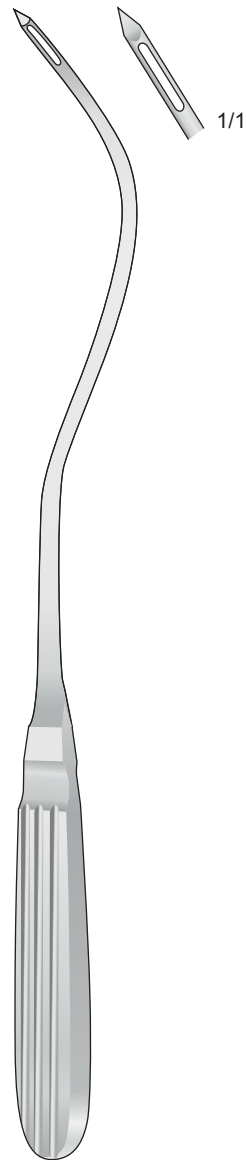
OBWEGESER  
**DO-30**  
140 mm



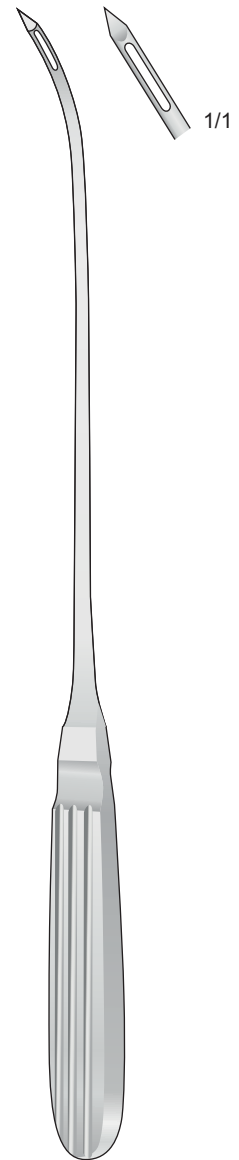
OBWEGESER  
**DO-31**  
230 mm



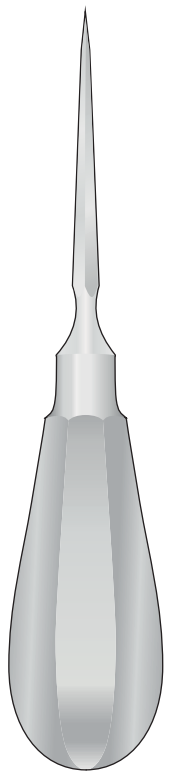
**DO-32**  
180 mm



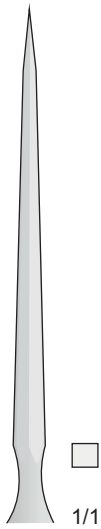
SANDERS-BROWN  
**DO-44**  
290 mm



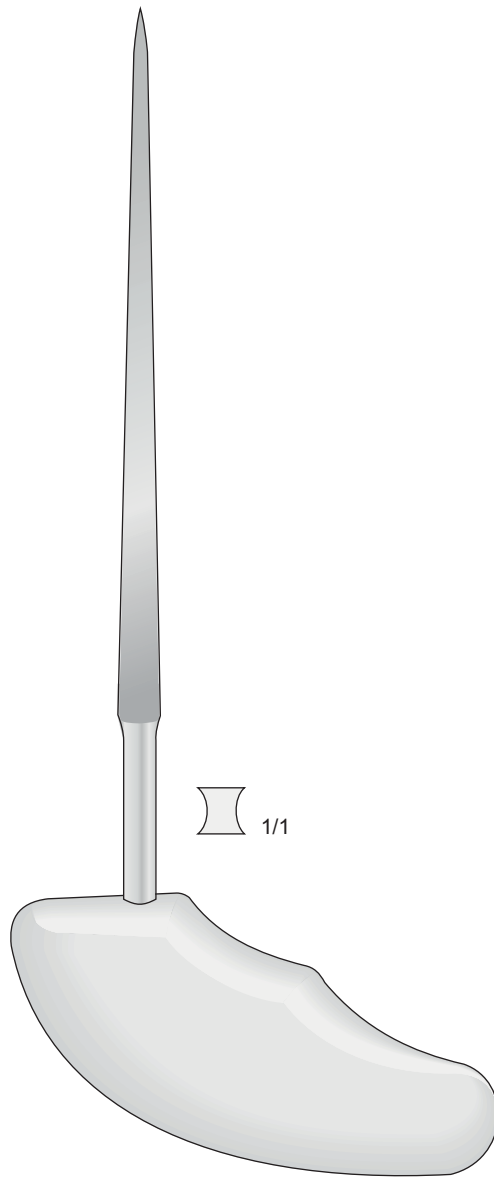
SANDERS-BROWN  
**DO-49**  
300 mm



**TR-77**  
140 mm



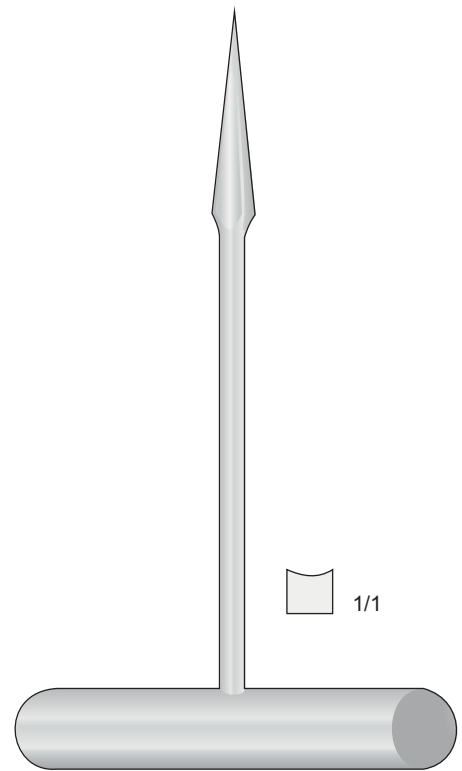
□  
1/1



**PERTHES  
TR-78**  
210 mm



1/1



**TR-76**  
140 mm







1/1

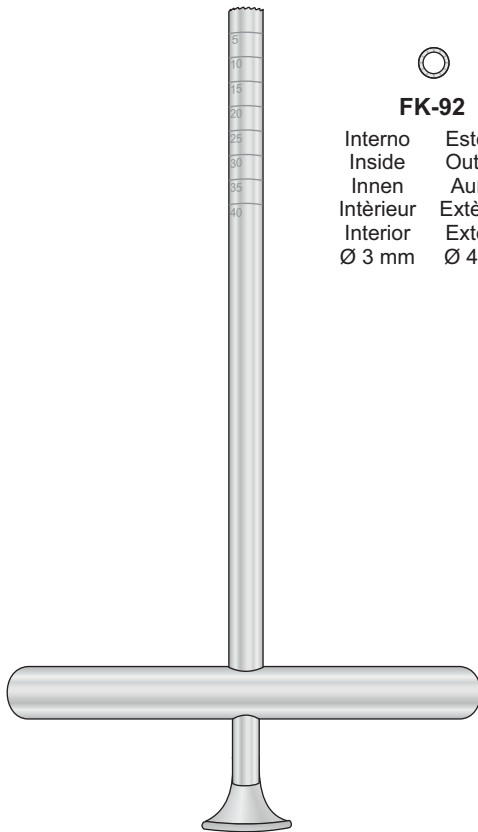





Punche da biopsia - Hautstanzen  
Dermal punches - Trépanos cutanés - Trépanos cutáneos



-   
**FL-150**  
 3 mm
-   
**FL-151**  
 4 mm
-   
**FL-152**  
 5 mm
-   
**FL-153**  
 6 mm

KEYES  
FL-150/FL-153  
100 mm



- |   |   |   |
|---|---|---|
|  |  |  |
| <b>FK-92</b>  | <b>FK-90</b>  | <b>FK-91</b>  |
| Interno    Esterno  | Interno    Esterno  | Interno    Esterno  |
| Inside    Outside   | Inside    Outside   | Inside    Outside   |
| Innen    Außen  | Innen    Außen  | Innen    Außen  |
| Intérieur    Extérieur  | Intérieur    Extérieur  | Intérieur    Extérieur  |
| Interior    Exterior  | Interior    Exterior  | Interior    Exterior  |
| Ø 3 mm    Ø 4 mm  | Ø 3,9 mm    Ø 5 mm  | Ø 6,4 mm    Ø 8 mm  |

FK-90/FK-92  
170 mm



**FK-100**

Set completo di 4 pezzi  
Set complete with 4 pieces  
Komplettset mit 4 Teilen  
Set complet avec 4 pièces  
Set completo con 4 piezas

Ø 8 mm



1/1

Ø 6,5 mm



Ø 6,5 mm



Ø 5 mm



1/1



**FK-101**  
145 mm



**FK-102**  
163 mm



**FK-103**  
208 mm



**FK-104**  
220 mm



**FK-105**

Set completo di 4 pezzi  
Set complete with 4 pieces  
Kompletset mit 4 Teilen  
Set complet avec 4 pièces  
Set completo con 4 piezas

Ø 5 mm



1/1



**FK-106**  
145 mm

Ø 3,9 mm



**FK-107**  
163 mm

Ø 3,9 mm



**FK-108**  
208 mm

Ø 3 mm



1/1



**FK-109**  
220 mm



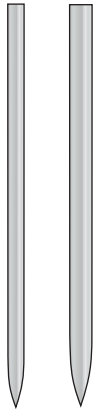
**KIRSCHNER**  
 Punta trequarti  
 Trocar point  
 Trokarspitze  
 Pointe de Trocart  
 Punta de trocar



**KIRSCHNER**  
 Punta trequarti  
 Trocar point  
 Trokarspitze  
 Pointe de Trocart  
 Punta de trocar

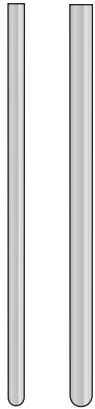


**KIRSCHNER**  
 Punta lanceolate  
 Lance point  
 Lanzenspitze  
 Pointe lancette  
 Punta lanceolar



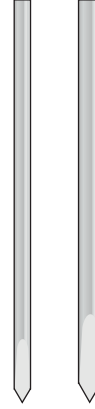
Punta trequarti  
 Trocar point  
 Trokarspitze  
 Pointe de Trocart  
 Punta de trocar

310 mm



Punta rotonda  
 Round shaft  
 Rundes ende  
 Pointe ronde  
 Punta redonda

310 mm



Punta lanceolate  
 Lance point  
 Lanzenspitze  
 Pointe lancette  
 Punta lanceolar

310 mm

Ø/Diam.	Conf. 10 pz.
0,8 mm	<b>KI-99</b>
1,0 mm	<b>KI-100</b>
1,2 mm	<b>KI-102</b>
1,4 mm	<b>KI-114</b>
1,5 mm	<b>KI-115</b>
1,6 mm	<b>KI-116</b>
1,7 mm	<b>KI-117</b>
1,8 mm	<b>KI-118</b>
2,0 mm	<b>KI-120</b>
2,2 mm	<b>KI-122</b>
2,5 mm	<b>KI-125</b>
3,0 mm	<b>KI-130</b>

Ø/Diam.	Conf. 10 pz.
0,8 mm	<b>KI-00</b>
1,0 mm	<b>KI-01</b>
1,2 mm	<b>KI-02</b>
1,4 mm	<b>KI-14</b>
1,5 mm	<b>KI-15</b>
1,6 mm	<b>KI-16</b>
1,7 mm	<b>KI-17</b>
1,8 mm	<b>KI-18</b>
2,0 mm	<b>KI-20</b>
2,2 mm	<b>KI-22</b>
2,5 mm	<b>KI-25</b>
3,0 mm	<b>KI-30</b>

Ø/Diam.	Conf. 10 pz.
0,8 mm	<b>KI-40</b>
1,0 mm	<b>KI-41</b>
1,2 mm	<b>KI-42</b>
1,5 mm	<b>KI-43</b>
1,6 mm	<b>KI-44</b>
1,8 mm	<b>KI-45</b>
2,0 mm	<b>KI-46</b>
2,2 mm	<b>KI-47</b>
2,5 mm	<b>KI-48</b>
3,0 mm	<b>KI-49</b>





KIRSCHNER  
Punta trequarti  
Trocar point  
Trokar Spitze  
Pointe de Trocart  
Punta de trocar

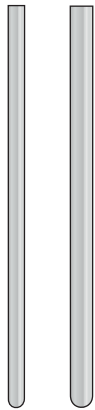


KIRSCHNER  
Punta trequarti  
Trocar point  
Trokar Spitze  
Pointe de Trocart  
Punta de trocar



15 mm

Con filettatura  
With thread  
Mit Gewinde  
Avec filetage  
Con rosca



Punta rotonda  
Round shaft  
Rundes ende  
Pointe ronde  
Punta redonda

150 mm



Punta trequarti  
Trocar point  
Trokar Spitze  
Pointe de Trocart  
Punta de trocar

150 mm



Rotonda  
Round  
Runde  
Ronde  
Redonda

O

Ø/Diam.	Conf. 10 pz.
0,8 mm	<b>KI-69</b>
1,0 mm	<b>KI-70</b>
1,2 mm	<b>KI-72</b>
1,4 mm	<b>KI-74</b>
1,5 mm	<b>KI-75</b>
1,6 mm	<b>KI-76</b>
1,7 mm	<b>KI-77</b>
1,8 mm	<b>KI-78</b>
2,0 mm	<b>KI-80</b>
2,2 mm	<b>KI-82</b>
2,5 mm	<b>KI-85</b>
3,0 mm	<b>KI-90</b>

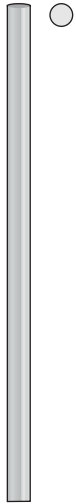
Ø/Diam.	Conf. 10 pz.
0,8 mm	<b>KI-60</b>
1,0 mm	<b>KI-61</b>
1,2 mm	<b>KI-62</b>
1,4 mm	<b>KI-63</b>
1,6 mm	<b>KI-64</b>

KIRSCHNER			
Codice	Ø mm	Lung.	Lung. filo
<b>KI-220</b>	1,5	150	5
<b>KI-221</b>	1,6	150	15
<b>KI-222</b>	2	150	15
<b>KI-223</b>	2	200	15



## KIRSCHNER

Bundel-Nagel



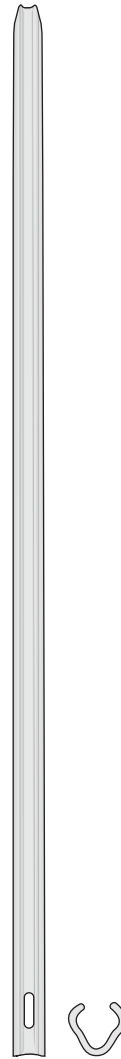
500 mm

Steinmann pins



310 mm

Kuntscher



400 mm

Threaded Steinmann Pins



230 mm

Runde

Ø/Diam.	Conf. 10 pz.
2,0 mm	<b>KI-50</b>
2,5 mm	<b>KI-51</b>
3,0 mm	<b>KI-52</b>
3,5 mm	<b>KI-53</b>
4,0 mm	<b>KI-54</b>
4,5 mm	<b>KI-55</b>
5,0 mm	<b>KI-56</b>
5,5 mm	<b>KI-57</b>
6,0 mm	<b>KI-58</b>

Ø/Diam.	Conf. 1 pz.
3,5 mm	<b>KI-280</b>
4,0 mm	<b>KI-282</b>
4,5 mm	<b>KI-284</b>
5,0 mm	<b>KI-286</b>
6,0 mm	<b>KI-288</b>
6,5 mm	<b>KI-290</b>

Ø/Diam.	Conf. 1 pz.
6,0 mm	<b>KI-252</b>
7,0 mm	<b>KI-254</b>
8,0 mm	<b>KI-256</b>
9,0 mm	<b>KI-258</b>
10 mm	<b>KI-260</b>
11 mm	<b>KI-262</b>
12 mm	<b>KI-264</b>

Ø/Diam.	Conf. 1 pz.
2,0 mm	<b>KI-160</b>
2,5 mm	<b>KI-161</b>



Steinmann Pins with Central Thread with Trocar Point

Contenitore per  
sterilizzazione Kirschner  
Bohrdrahtspender



Positivo  
Thread - Ø is 0,5 mm  
more than pin - Ø

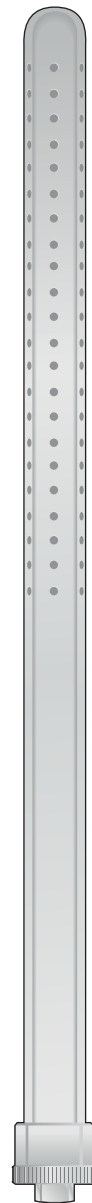
3 Kant



KI-175/KI-199

STEINMANN PINS			
Codice	Ø mm	Lung.	Lung. Filo mm
KI-175	3	150	37
KI-176	3	180	48
KI-177	3	200	50
KI-178	3	230	52
KI-179	3,5	150	37
KI-180	3,5	180	52
KI-181	3,5	200	52
KI-182	3,5	230	52
KI-183	4	150	37
KI-184	4	180	52
KI-185	4	200	50
KI-186	4	230	52
KI-187	4	250	52
KI-188	4,5	150	37
KI-189	4,5	180	52
KI-190	4,5	200	52
KI-191	4,5	230	52
KI-192	4,5	250	52
KI-193	4,5	300	52
KI-194	5	150	37
KI-195	5	180	52
KI-196	5	200	50
KI-197	5	230	52
KI-198	5	250	52
KI-199	5	300	52

Ø 10 mm

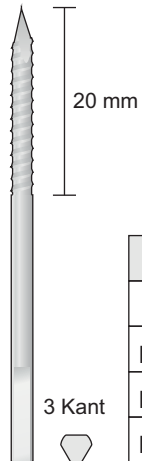


KI-300 - 320 mm  
KI-301 - 190 mm



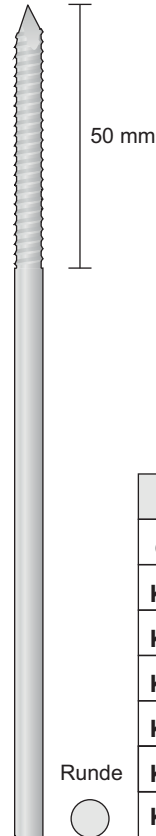
Viti di Schanz  
Shanz screws  
Schanz'sche Schrauben  
Vis de Schanz

Negativo



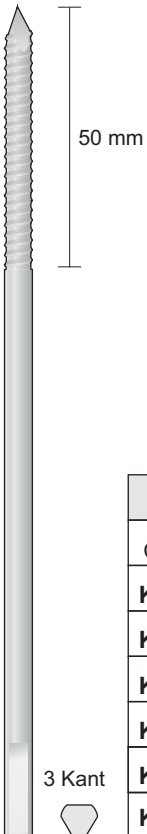
SCHANZ			
Codice	Ø mm	Lung.	Lung. filo
KI-230	3	60	20
KI-231	3	80	20
KI-232	4	60	25

Negativo



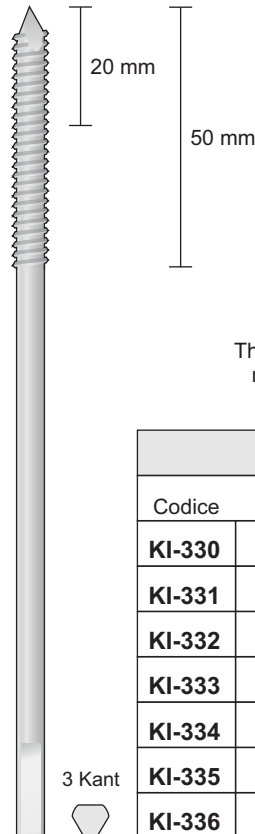
SCHANZ			
Codice	Ø mm	Lung.	Lung. filo
KI-293	2	150	50
KI-294	3	150	50
KI-295	3,5	150	50
KI-296	4	150	50
KI-297	4,5	150	50
KI-298	5	150	50

Negativo



SCHANZ			
Codice	Ø mm	Lung.	Lung. filo
KI-238	2	150	50
KI-240	3	150	50
KI-242	3,5	150	50
KI-244	4	150	50
KI-246	4,5	150	50
KI-248	5	150	50

Positivo



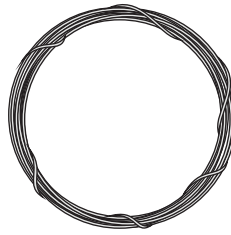
Thread - Ø is 0,5 mm  
more than pin - Ø

SCHANZ			
Codice	Ø mm	Lung.	Lung. filo
KI-330	2	150	20
KI-331	3	150	20
KI-332	3,5	150	50
KI-333	4	150	25
KI-334	4	150	50
KI-335	4,5	150	50
KI-336	5	150	50



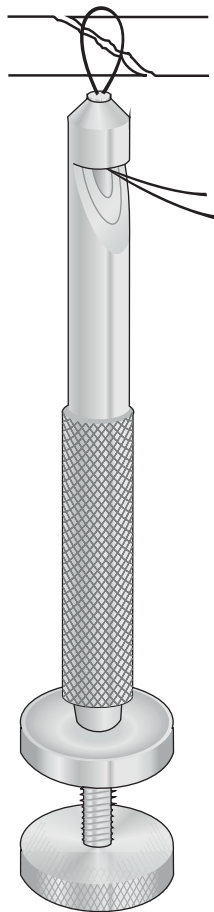
Strumenti per filo di cerchiaggio  
Wire instrument set  
Drahtinstrumentarium  
Instruments à fil  
Instrumental para cerclaje

Filo malleabile  
per compattare l'osso  
Wire soft  
Draht weich  
Fil à os  
Alambre ligadura



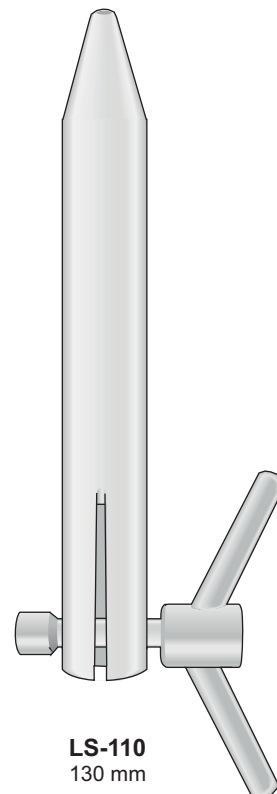
10 mt.

Ø/Diam.	Codice
0,2 mm	<b>KI-202</b>
0,3 mm	<b>KI-203</b>
0,4 mm	<b>KI-204</b>
0,5 mm	<b>KI-205</b>
0,6 mm	<b>KI-206</b>
0,7 mm	<b>KI-207</b>
0,8 mm	<b>KI-208</b>
0,9 mm	<b>KI-209</b>
1,0 mm	<b>KI-210</b>
1,2 mm	<b>KI-211</b>
1,5 mm	<b>KI-212</b>



LOUTE  
**KI-322**  
220 mm

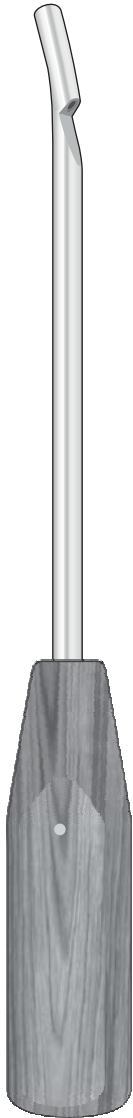
Strumenti tendifili  
Bone wire tighteners  
Drahtspanninstrument  
Tendeur serre fils  
Tensor cierra-hilos



**LS-110**  
130 mm

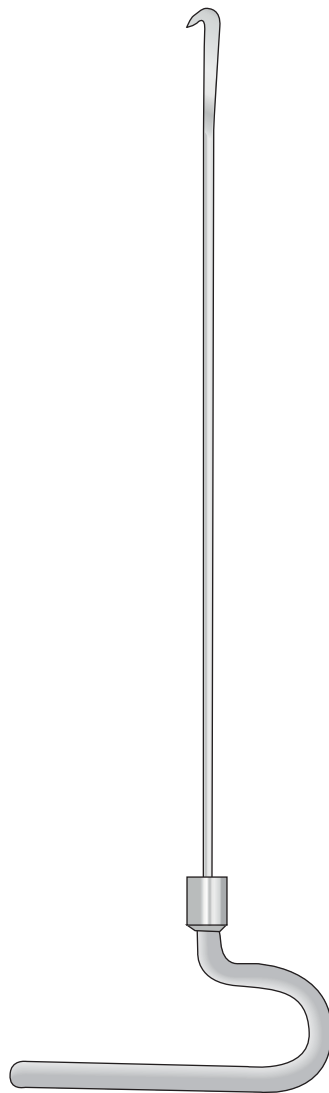


Fino a Ø 3 mm  
Bis Ø 3 mm  
Up to Ø 3 mm



WAGNER  
**LS-106**  
300 mm

Gancio d'estrazione  
Extraction hooks  
Extraktionshaken  
Crochets d'extraction  
Ganchos extractores



**KI-306** - 290 mm  
**KI-307** - 370 mm  
**KI-308** - 420 mm



**LS-100**  
120 mm

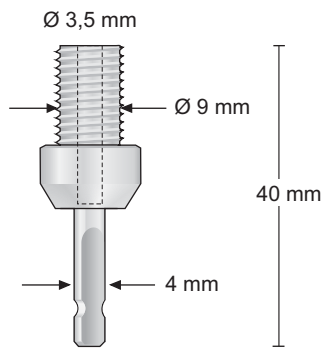


KÜNTSCHNER  
**FK-09**  
210 mm



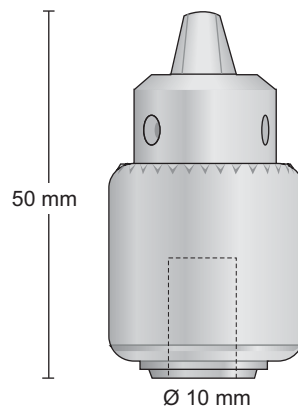
**LS-233**  
Completo con - Complete with  
Komplett mit - Completes avec  
Completos con:  
1 **LS-236**  
1 **LS-229**  
1 **LS-241**

Attacco AO

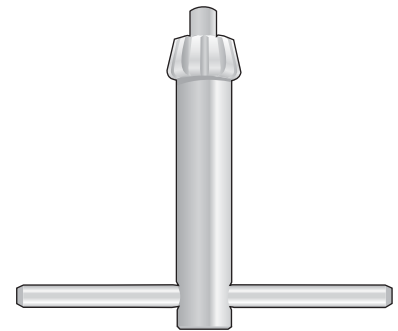


**LS-227**  
40 mm

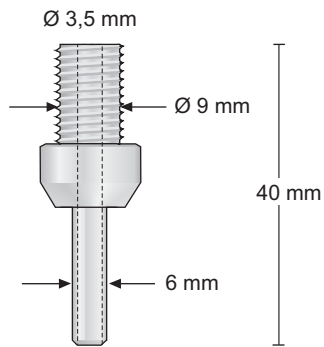
Inox  
ORIGINAL JACOBS



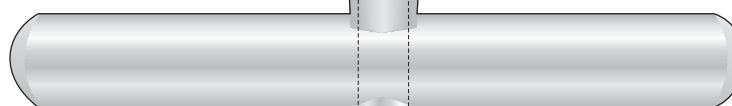
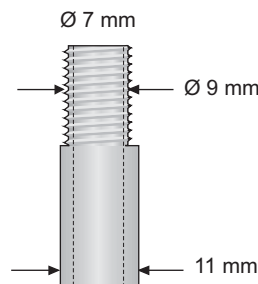
**LS-236**  
50 mm



**LS-241**  
52 mm



**LS-228**  
40 mm

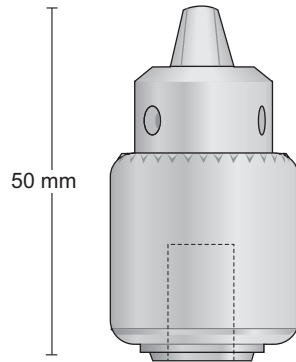


**LS-229**  
85 mm



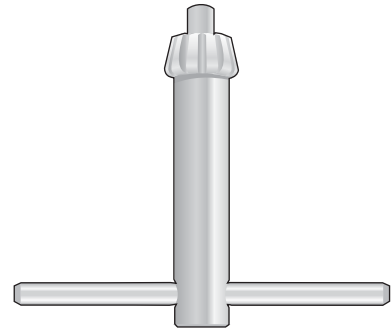
**LS-239**  
Completo con - Complete with  
Komplett mit - Completes avec  
Completo con:  
1 **LS-236**  
1 **LS-237**  
1 **LS-238**  
1 **LS-241**

Inox  
ORIGINAL JACOBS

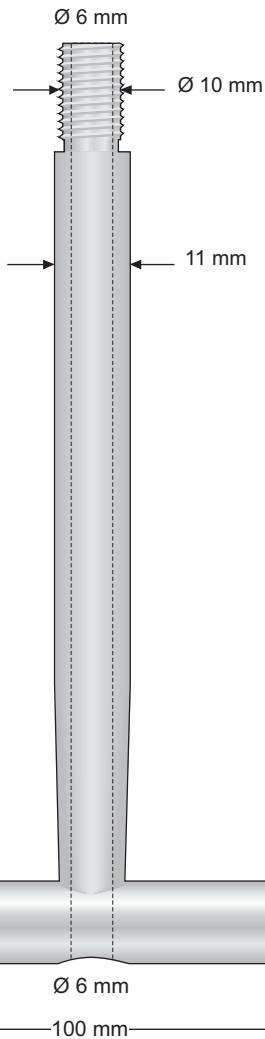
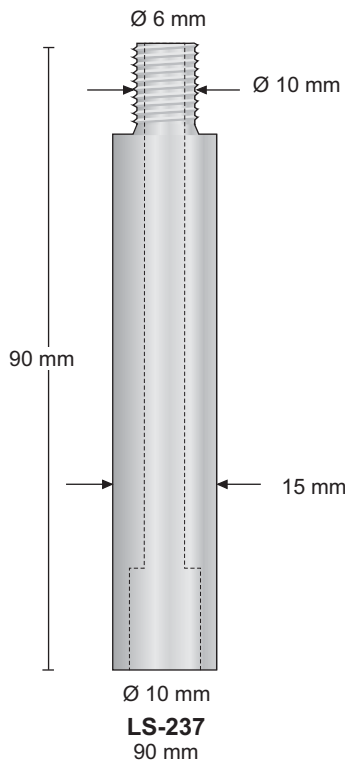


Ø 10 mm

**LS-236**  
50 mm

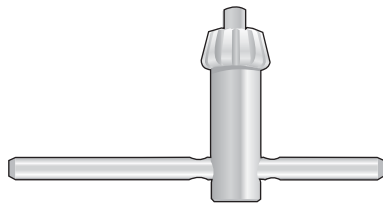


**LS-241**  
52 mm

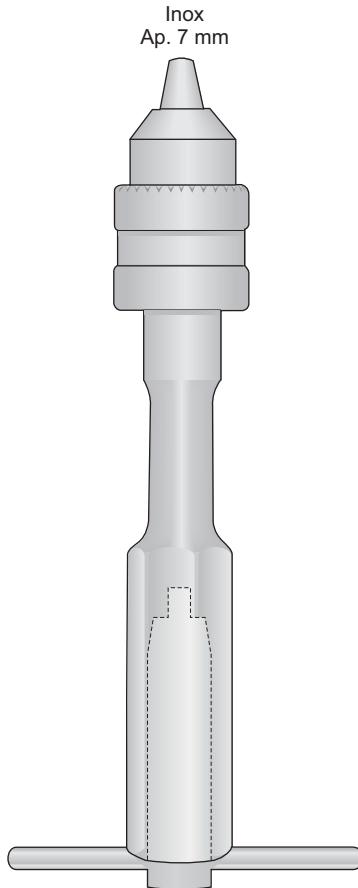


**LS-238**  
130 mm





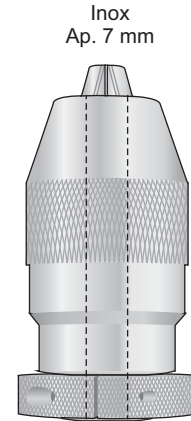
**LS-231**  
32 mm



Inox  
Ap. 7 mm

**LS-232**  
130 mm

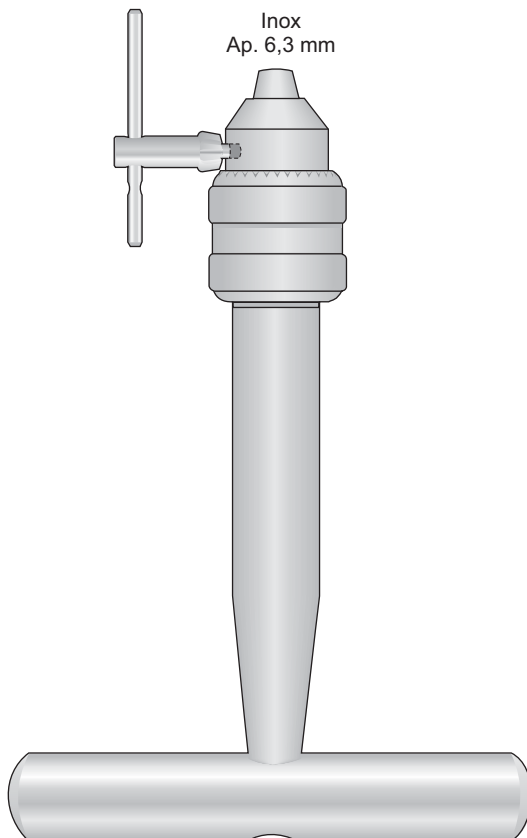
Con chiusura a mano  
Von Handt zu spannen  
Tightened by hand



Inox  
Ap. 7 mm

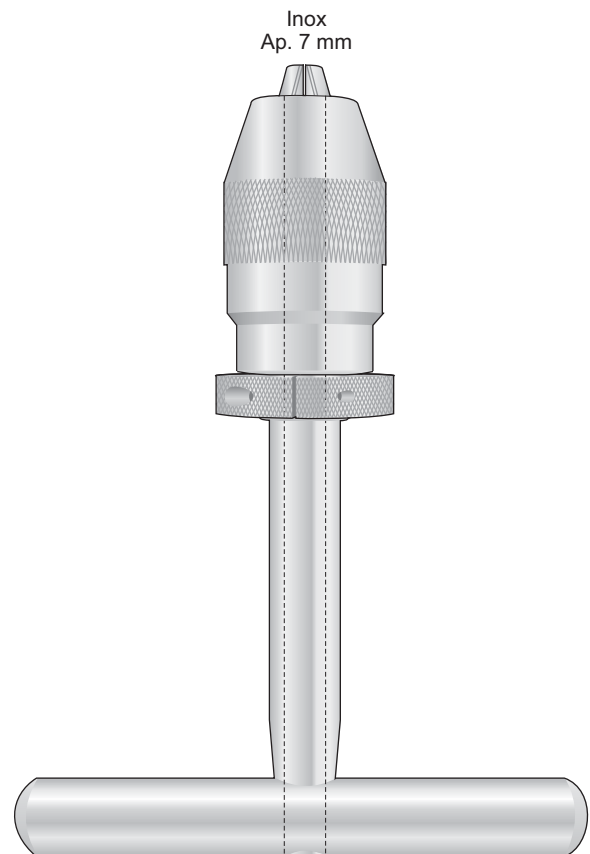
**LS-224**  
Mandrino solo

Con chiusura a mano  
Von Hand zu spannen  
tightened by hand



Inox  
Ap. 6,3 mm

**LS-230**  
130 mm

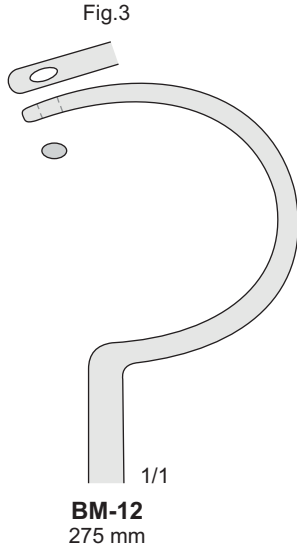


Inox  
Ap. 7 mm

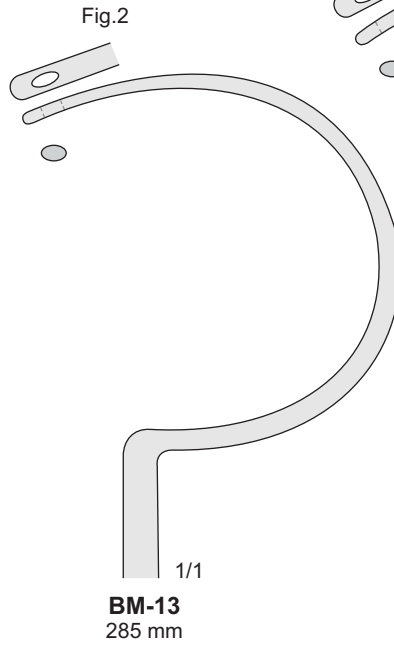
**LS-234**  
135 mm



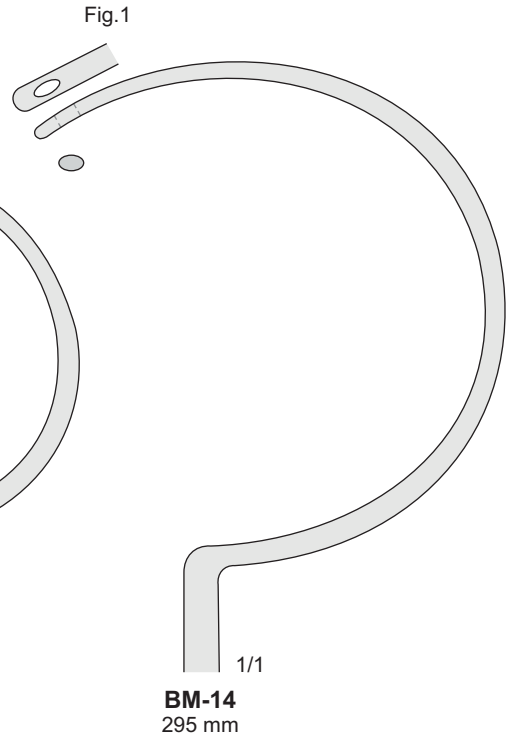
DEMEL  
BM-12/BM-14



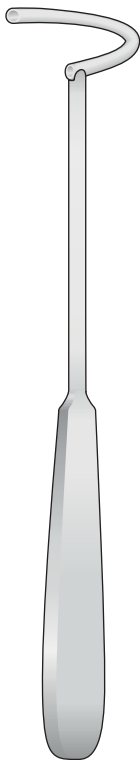
BM-12  
275 mm



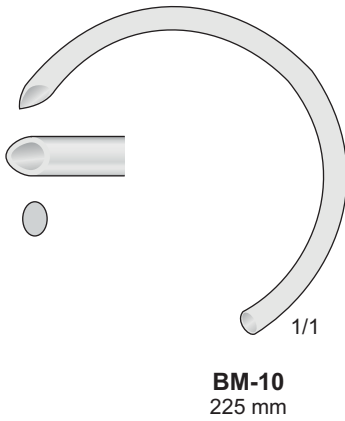
BM-13  
285 mm



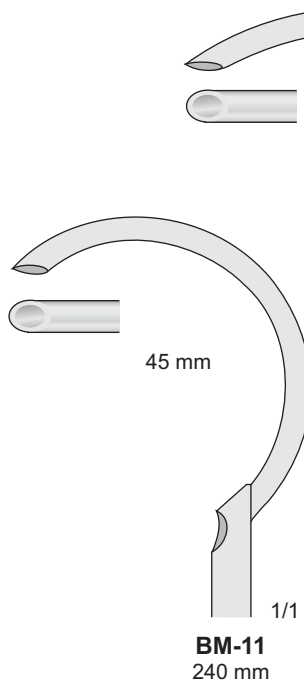
BM-14  
295 mm



BM-10  
225 mm

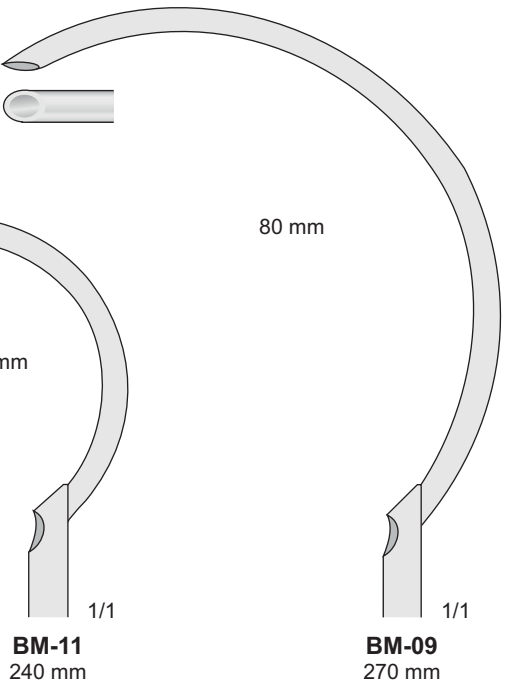


BM-10  
225 mm



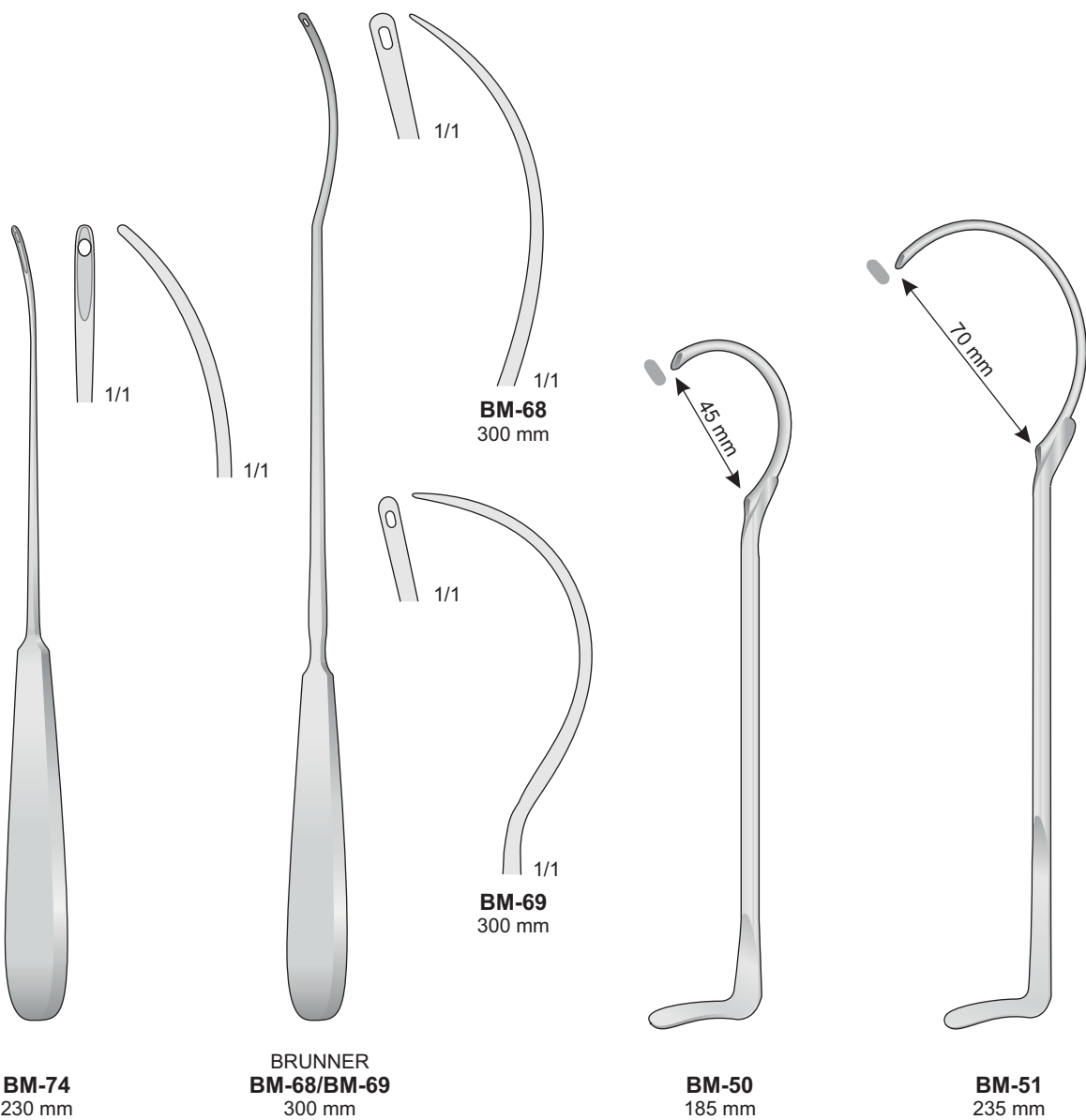
BM-11  
240 mm

45 mm



BM-09  
270 mm

80 mm





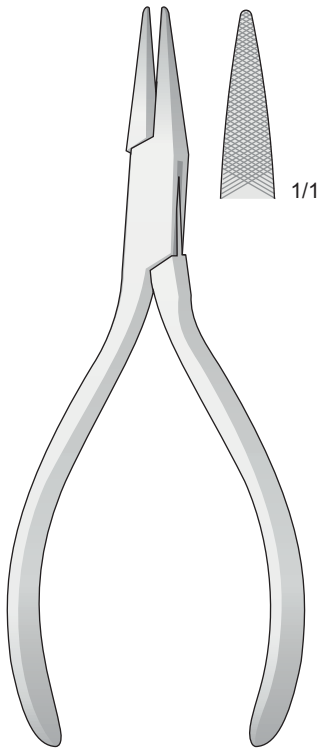
Pinze per estrazione  
fili metallici

Extraction pliers  
for boring wires

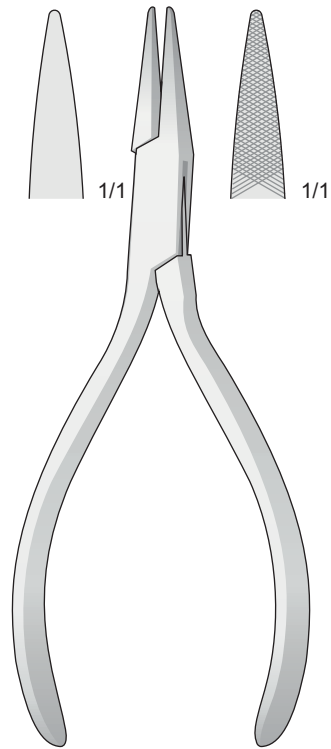
Extraktionszangen  
für Bohrdrähte

Pinces pour  
l'extraction des broches

Pinzas para extracción  
de hilo metálico

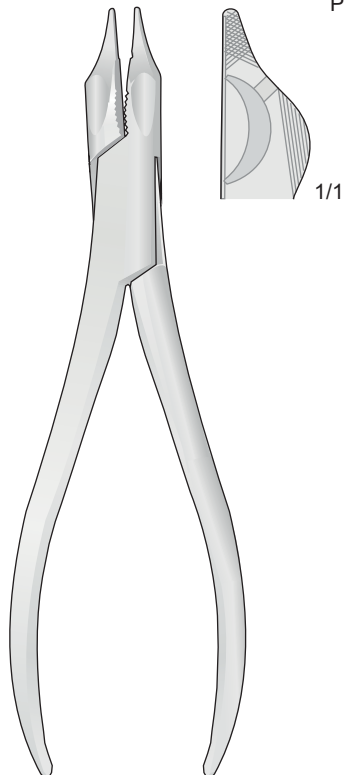


**DP-08**  
140 mm

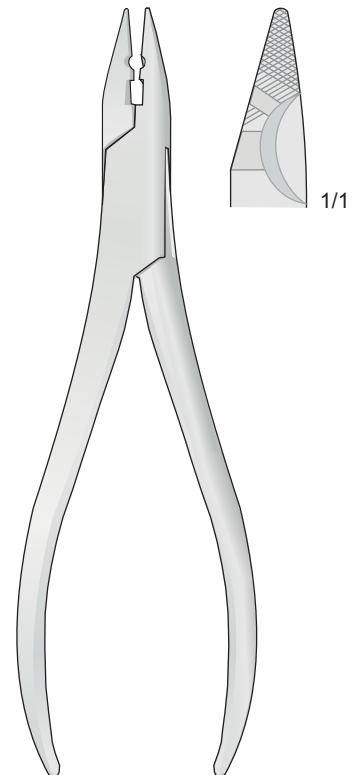


**DP-18**  
140 mm

Per filo duro ø 1 mm  
For hard wire ø 1 mm  
Für harten Draht ø 1 mm  
Pour fil dur ø 1 mm  
Para alambres duro ø 1 mm



**DP-71**  
150 mm



**DP-75**  
160 mm



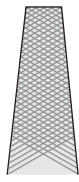
Pinze per estrazione  
fili metallici

Extraction pliers  
for boring wires

Extraktionszangen  
für bohrdrähte

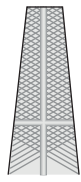
Pinces pour  
l'extraction des broches

Pinzas para extracción  
de hilo metálico



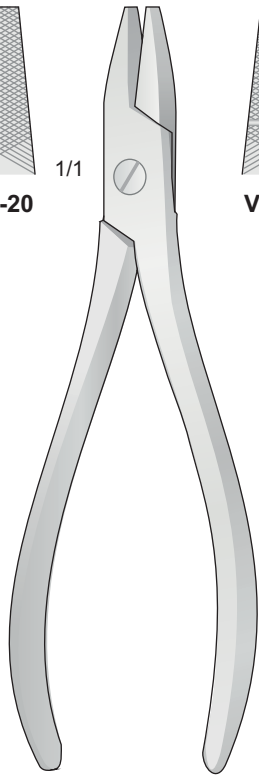
1/1

VH-20

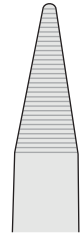


1/1

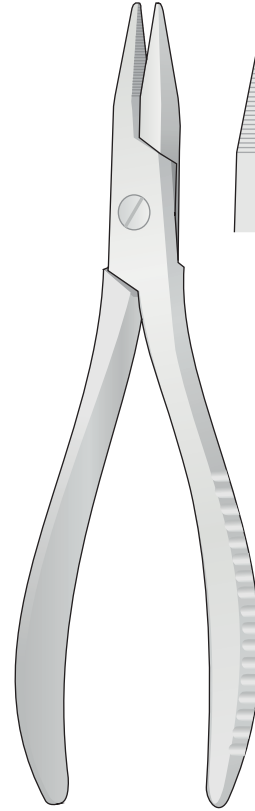
VH-21



VH-20/VH-21  
175 mm



1/1



VH-23  
190 mm

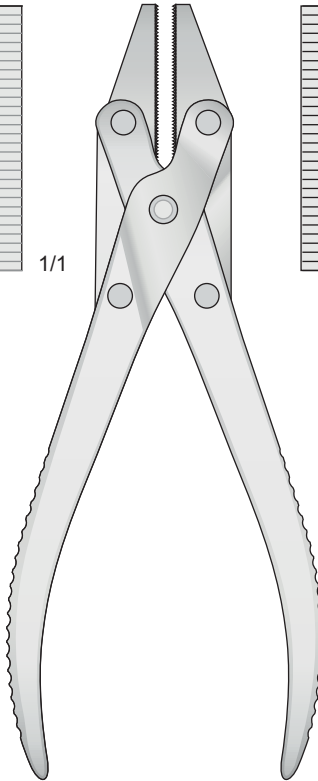
Pinza a branche parallele - Flat-nosed pliers, parallel  
Parallel-Flachzange - Pincas plates - Alicates planos



1/1



1/1

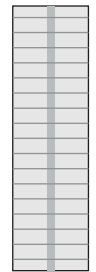


VH-25  
185 mm

Inox  
Stainless Steel  
Rostfrei

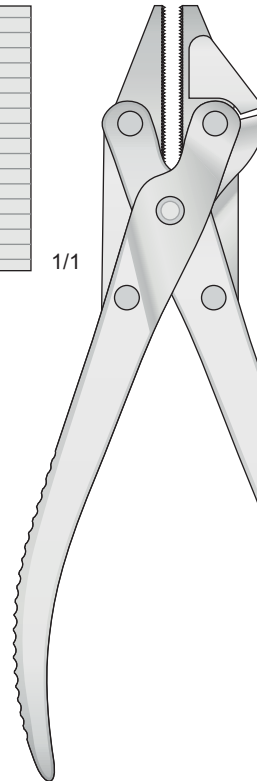


1/1



1/1

Pinza a branche parallele con tronchese  
Flat-nose pliers parallel with lateral wire cutter  
Parallel-Flachzange mit Seitenschneider



LX-80  
185 mm

Inox  
Stainless Steel  
Rostfrei



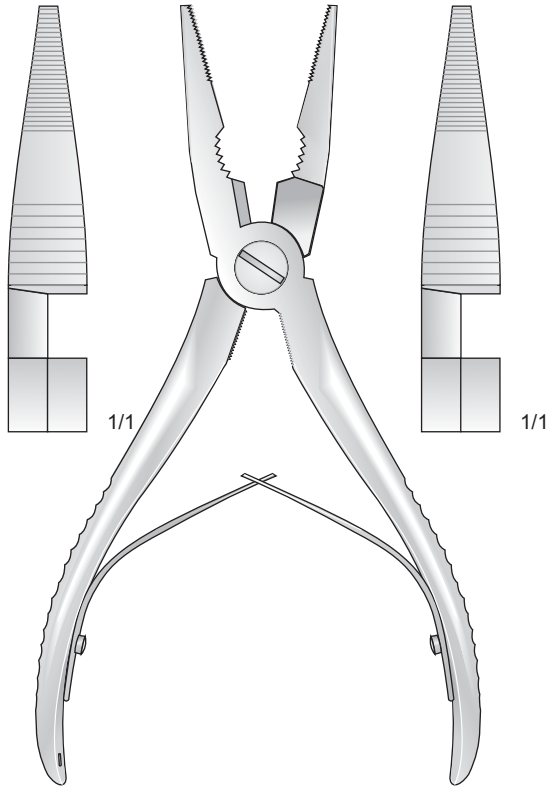
Pinze per estrazione  
fili metallici

Extraction pliers  
for boring wires

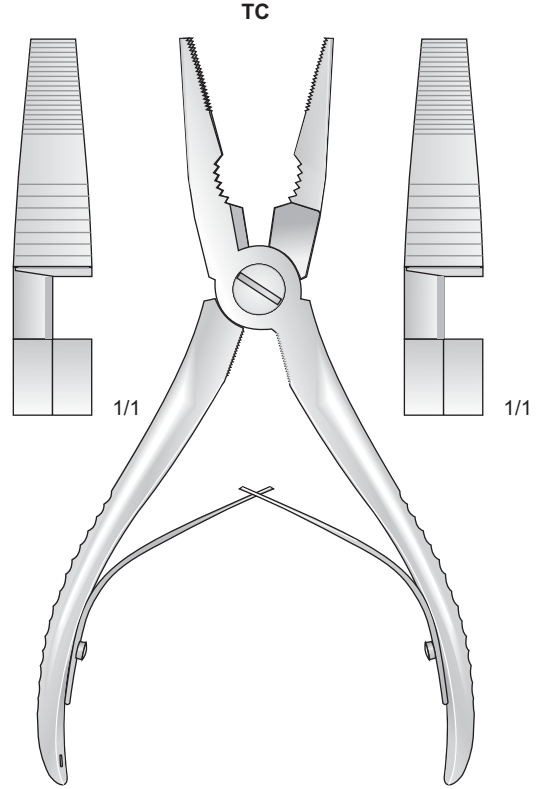
Extraktionszangen  
für Bohrdrähte

Pinces pour  
l'extraction des broches

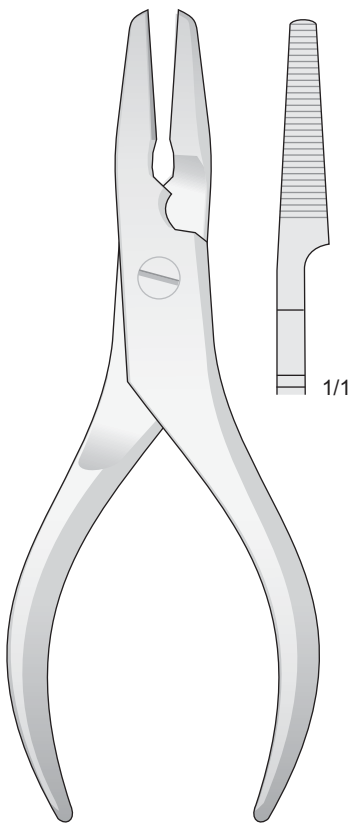
Pinzas para extracción  
de hilo metálico



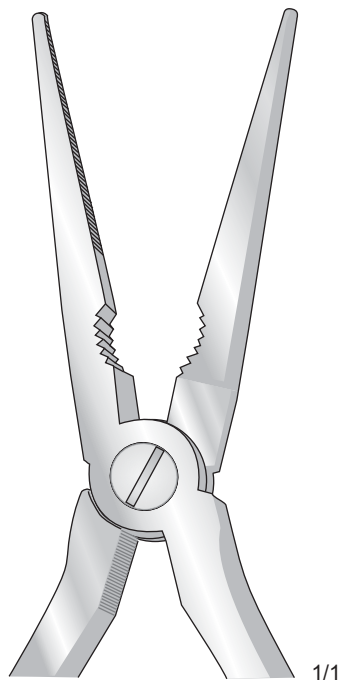
**LX-135**  
175 mm



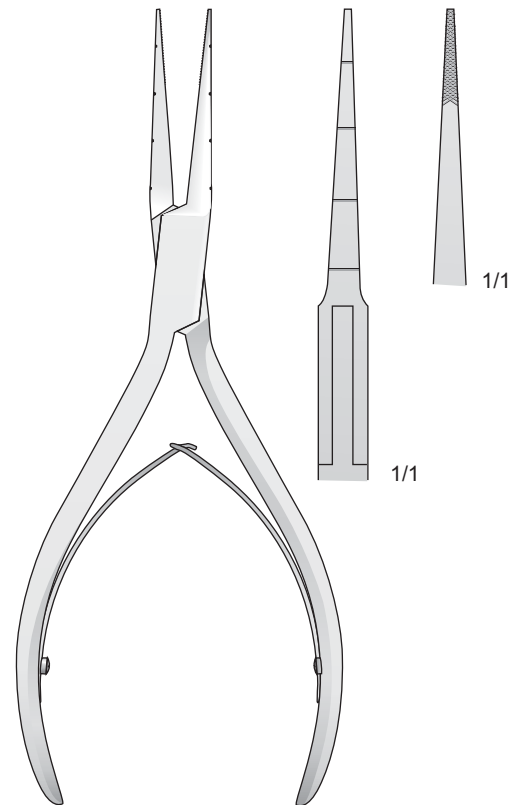
**LX-136**  
165 mm



**LX-134**  
160 mm



**LX-137**  
200 mm



**DP-96**  
150 mm



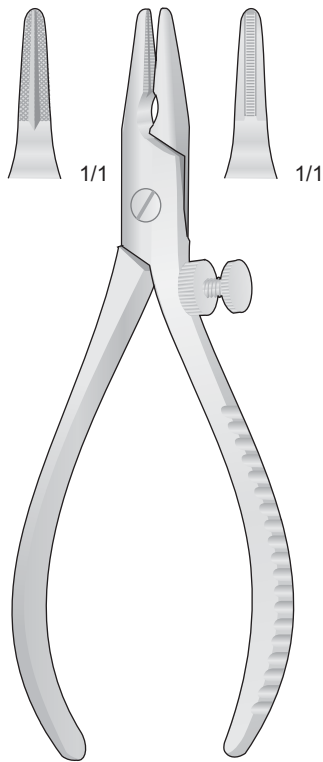
Pinze per estrazione  
fili metallici

Extraction pliers  
for boring wires

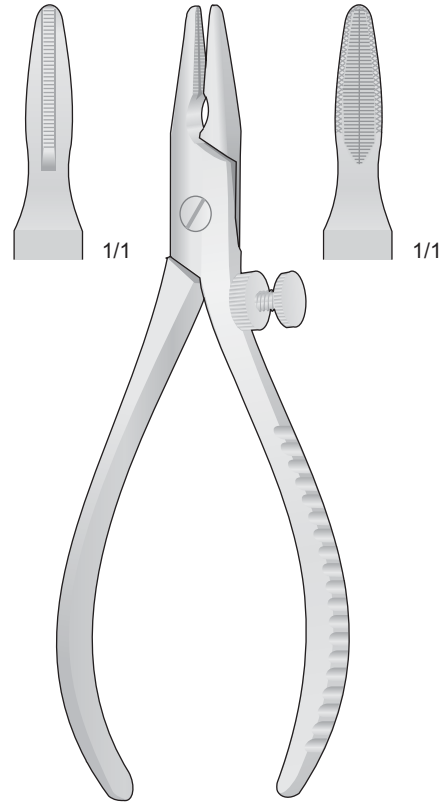
Extraktionszangen  
für Bohrdrähte

Pinces pour  
l'extraction des broches

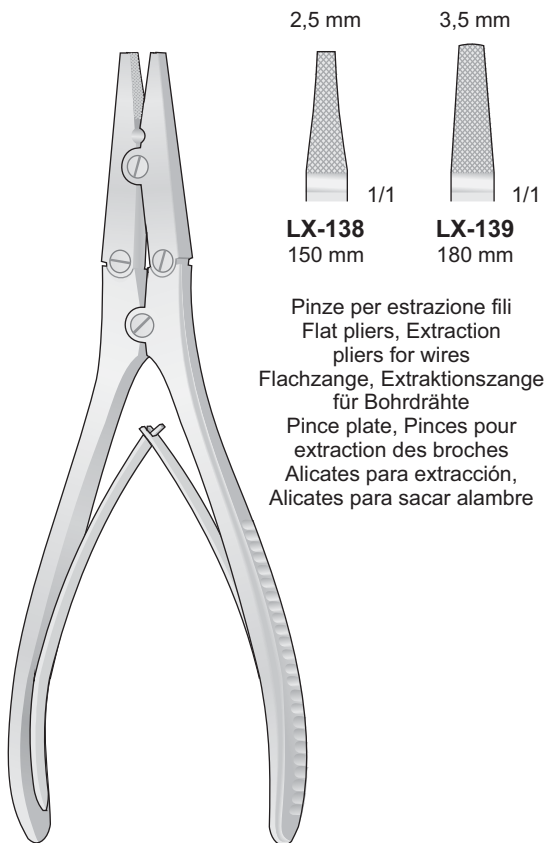
Pinzas para extracción  
de hilo metálico



**LX-130**  
140 mm



**LX-131**  
180 mm



2,5 mm

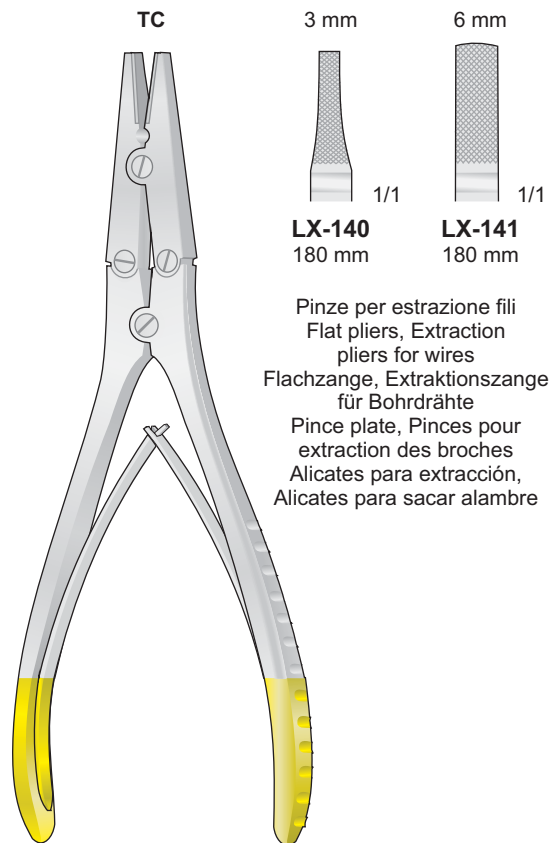
3,5 mm

**LX-138**  
150 mm

**LX-139**  
180 mm

Pinze per estrazione fili  
Flat pliers, Extraction  
pliers for wires  
Flachzange, Extraktionszange  
für Bohrdrähte  
Pince plate, Pinces pour  
extraction des broches  
Alicates para extracción,  
Alicates para sacar alambre

**LX-138/LX-139**



TC

3 mm

6 mm

**LX-140**  
180 mm

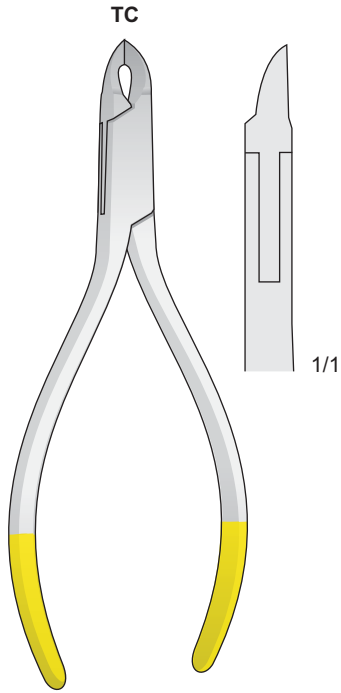
**LX-141**  
180 mm

Pinze per estrazione fili  
Flat pliers, Extraction  
pliers for wires  
Flachzange, Extraktionszange  
für Bohrdrähte  
Pince plate, Pinces pour  
extraction des broches  
Alicates para extracción,  
Alicates para sacar alambre

**LX-140/LX-141**

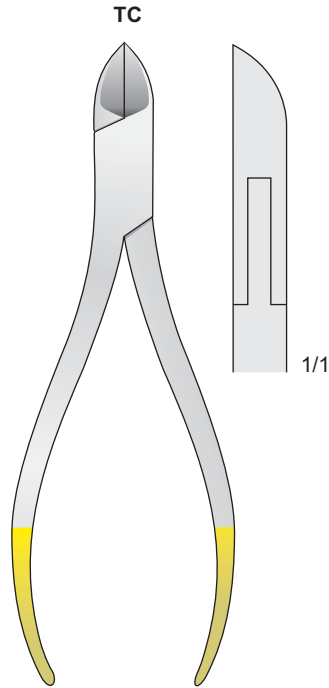


Per fili duri di  $\varnothing$  0,4 mm - For hard wire with  $\varnothing$  0,4 mm  
 Für harten Draht bis  $\varnothing$  0,4 mm - Pour fils durs avec  $\varnothing$  0,4 mm  
 Para alambres duros de  $\varnothing$  0,4 mm

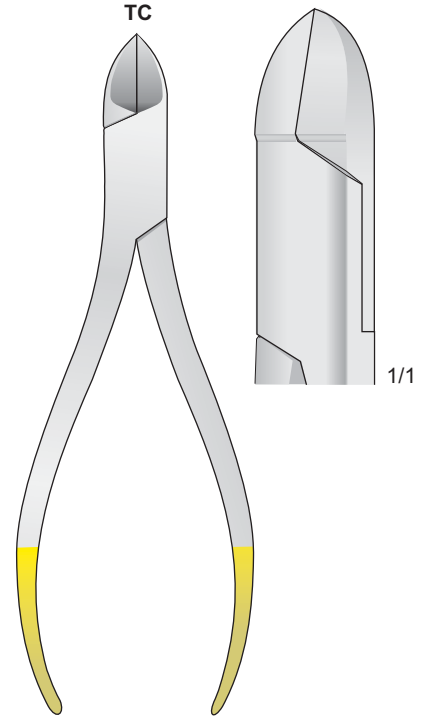


ANGLE  
**LX-95TC**  
 130 mm

Per filo duro  $\varnothing$  1 mm - For hard wire with  $\varnothing$  1 mm  
 Für harten Draht bis  $\varnothing$  1 mm - Pour fil dur avec  $\varnothing$  1 mm  
 Para alambres duro  $\varnothing$  1 mm

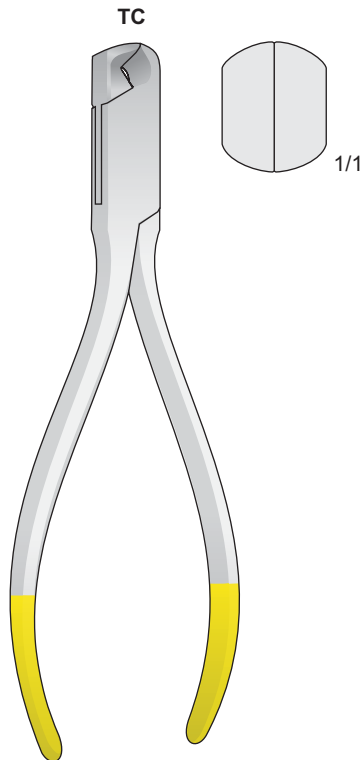


**LX-99**  
 130 mm



**LX-96TC**  
 150 mm

Per filo duro  $\varnothing$  1 mm - For hard wire with  $\varnothing$  1 mm  
 Für harten Draht bis  $\varnothing$  1 mm - Pour fil dur avec  $\varnothing$  1 mm  
 Para alambres duro  $\varnothing$  1 mm



**LX-92TC**  
 145 mm

Per filo duro  $\varnothing$  1,7 mm  
 For hard wire with  $\varnothing$  1,7 mm  
 Für harten Draht bis  $\varnothing$  1,7 mm  
 Pour fil dur avec  $\varnothing$  1,7 mm  
 Para alambres duro  $\varnothing$  1,7 mm

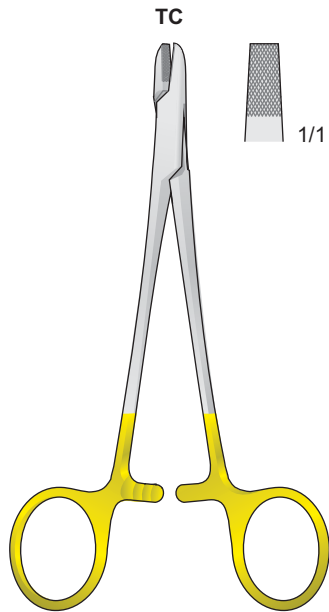


**LX-82**  
 185 mm

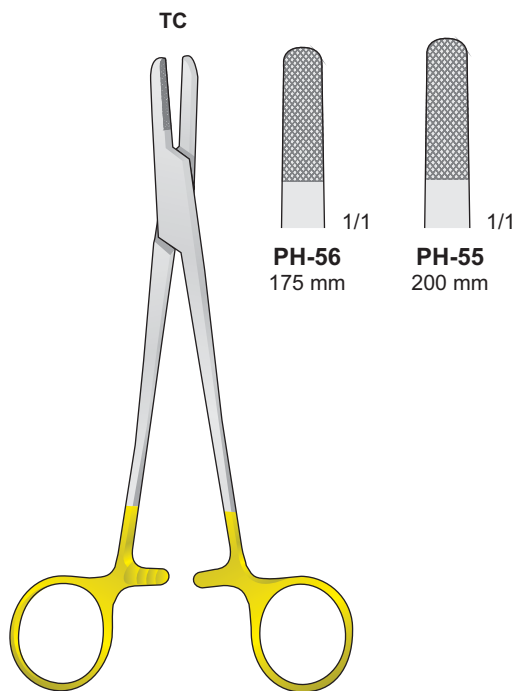




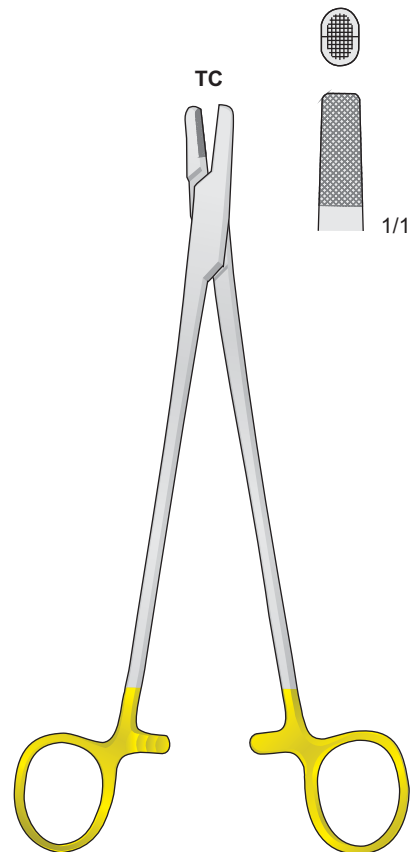
Port'aghi, pinze per fili d'acciaio - Needle holders, steel wire forceps  
Nadelhalter, Stahldrahtzangen - Porte aiguilles, pinces à saisir fils d'acier  
Porta agujas, pinzas para hilos de acero



**PH-58**  
150 mm



**PH-55/PH-56**



**BAUMGARTNER**  
**PH-57**  
200 mm



Pinze per estrazione  
fili metallici

Extraction pliers  
for boring wires

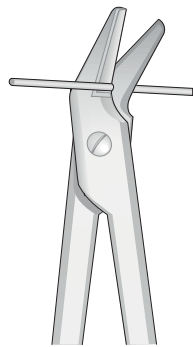
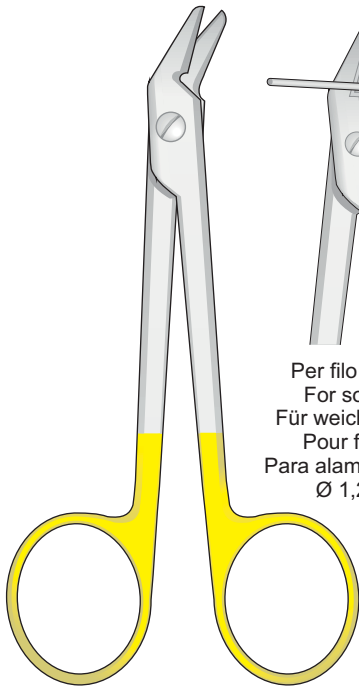
Extraktionszangen  
für Bohrdrähte

Pinces pour  
l'extraction des broches

Pinzas para extracción  
de hilo metálico

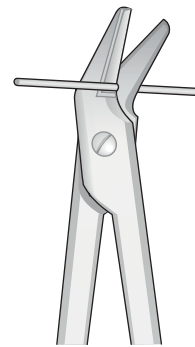
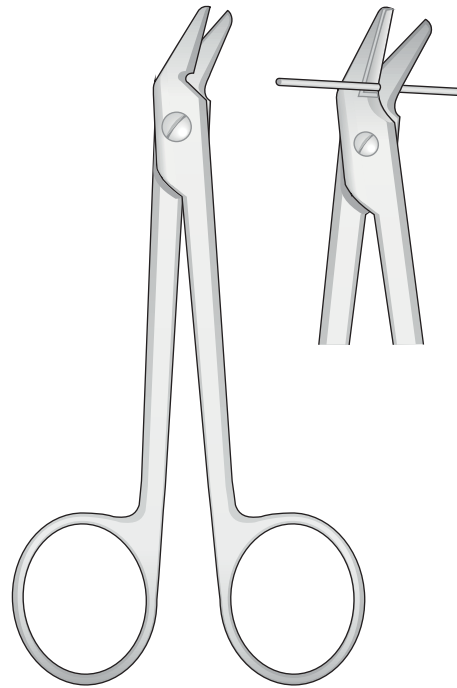
Forbice universale dentellata - Draht-und Blehschere gezahnt  
Wire cutting scissor serrated - Ciseaux à couper les fils métalliques  
Tijeras para cortar hilo de acero dentadas

TC



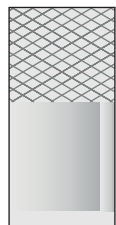
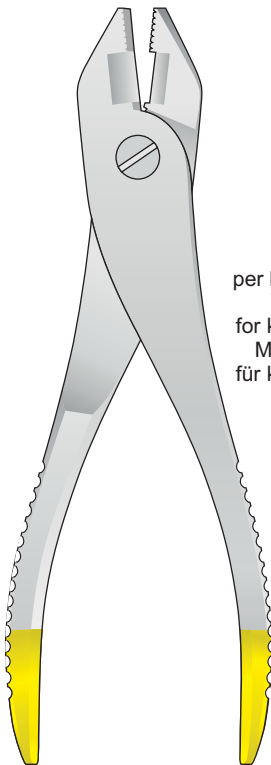
Per filo leggero  
For soft wire  
Für weichen Draht  
Pour fil léger  
Para alambres ligero  
Ø 1,2 mm

**DP-120**  
120 mm



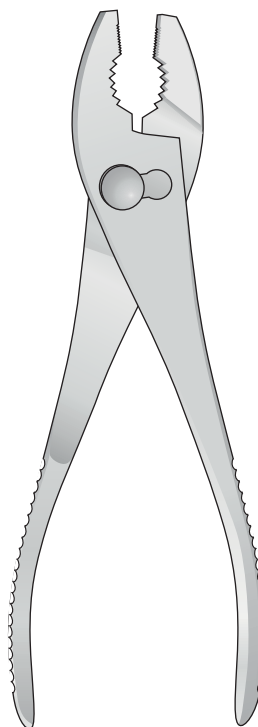
**DP-90**  
120 mm

TC

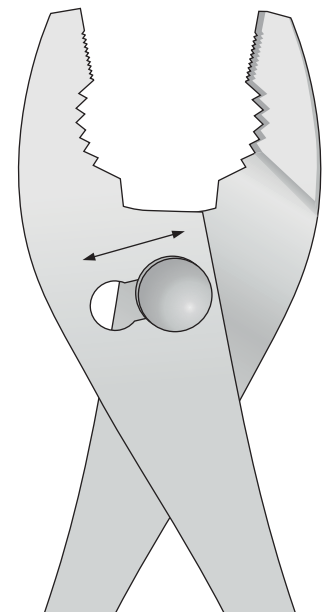


Con tronchese  
per kirschner Ø 1,5 mm  
With wire cutter  
for kirschner Ø 1,5 mm  
Mit Drahtschneider  
für kirschner Ø 1,5 mm

**LX-125**  
220 mm

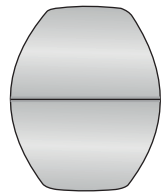


**VH-40**  
200 mm

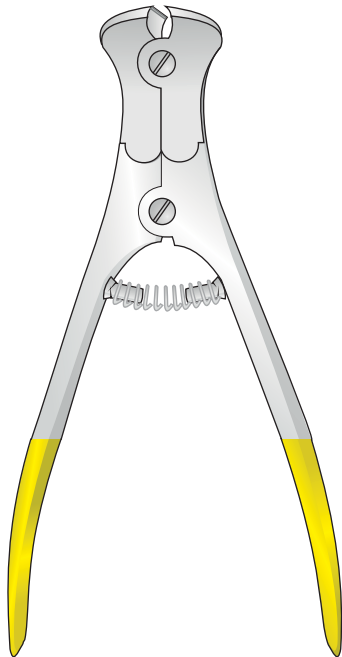




Per filo leggero Ø 2 mm  
Per filo duro Ø 1,5 mm  
For soft wire Ø 2 mm  
For hard wire Ø 1,5 mm  
Für weichen Draht Ø 2 mm  
Für harten Draht Ø 1,5 mm  
Pour fil léger Ø 2 mm  
Pour fil dur Ø 1,5 mm  
Para alambres ligero Ø 2 mm  
Para alambres duro Ø 1,5 mm



TC



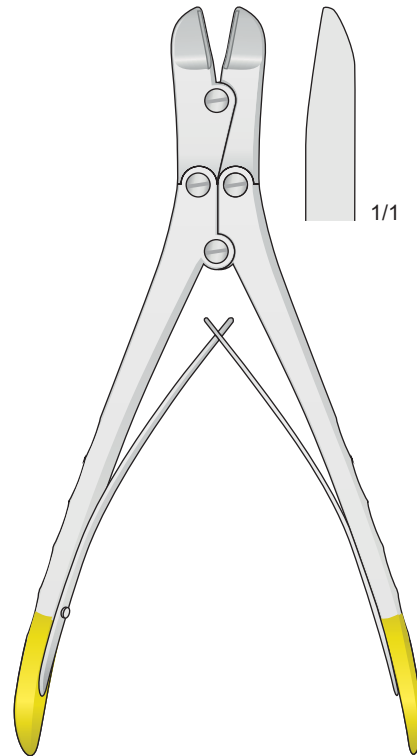
**LX-102**  
145 mm

Per filo leggero Ø 2 mm  
Per filo duro Ø 1,6 mm  
For soft wire Ø 2 mm  
For hard wire Ø 1,6 mm  
Für weichen Draht Ø 2 mm  
Für harten Draht Ø 1,6 mm  
Pour fil léger Ø 2 mm  
Pour fil dur Ø 1,6 mm  
Para alambres ligero Ø 2 mm  
Para alambres duro Ø 1,6 mm

TC



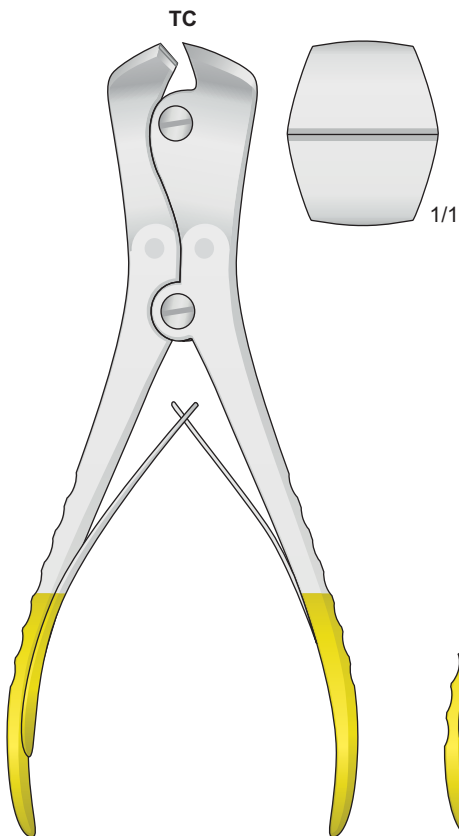
1/1



**LX-103**  
170 mm

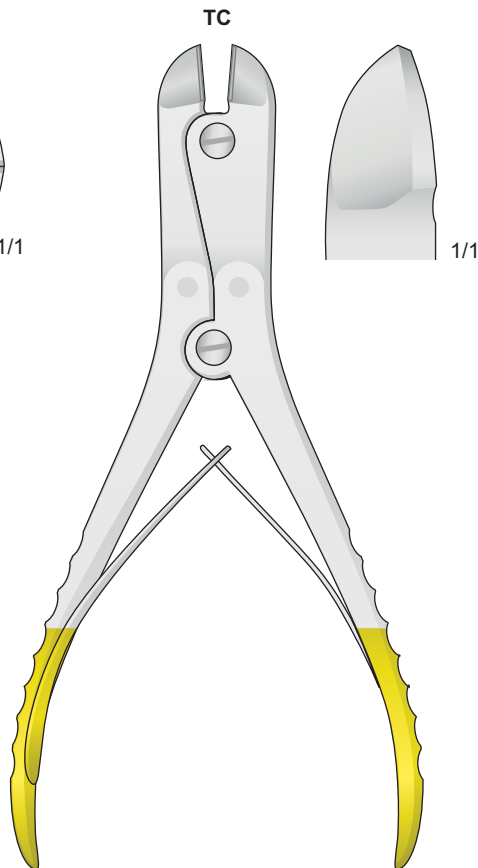


Per filo leggero Ø 3,5 mm  
Per filo duro Ø 2,5 mm  
For soft wire Ø 3,5 mm  
For hard wire Ø 2,5 mm  
Für weichen Draht Ø 3,5 mm  
Für harten Draht Ø 2,5 mm  
Pour fil léger Ø 3,5 mm  
Pour fil dur Ø 2,5 mm  
Para alambres ligero Ø 3,5 mm  
Para alambres duro Ø 2,5 mm



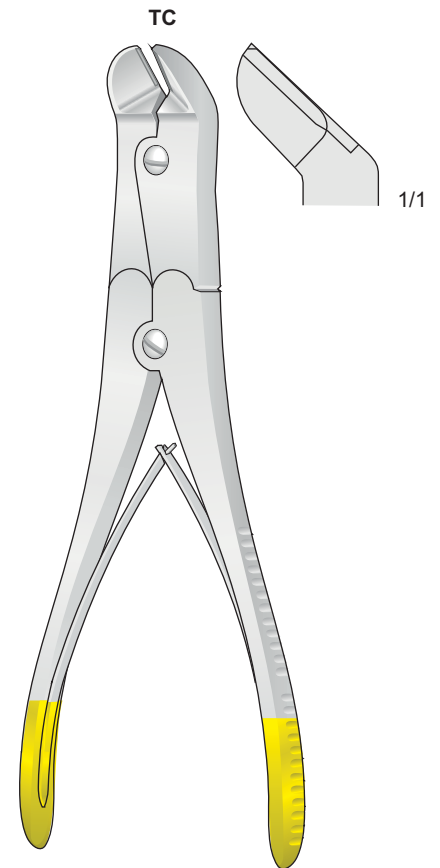
**LX-104**  
215 mm

Per filo leggero Ø 3 mm  
Per filo duro Ø 2,2 mm  
For soft wire Ø 3 mm  
For hard wire Ø 2,2 mm  
Für weichen Draht Ø 3 mm  
Für harten Draht Ø 2,2 mm  
Pour fil léger Ø 3 mm  
Pour fil dur Ø 2,2 mm  
Para alambres ligero Ø 3 mm  
Para alambres duro Ø 2,2 mm



**LX-106**  
230 mm

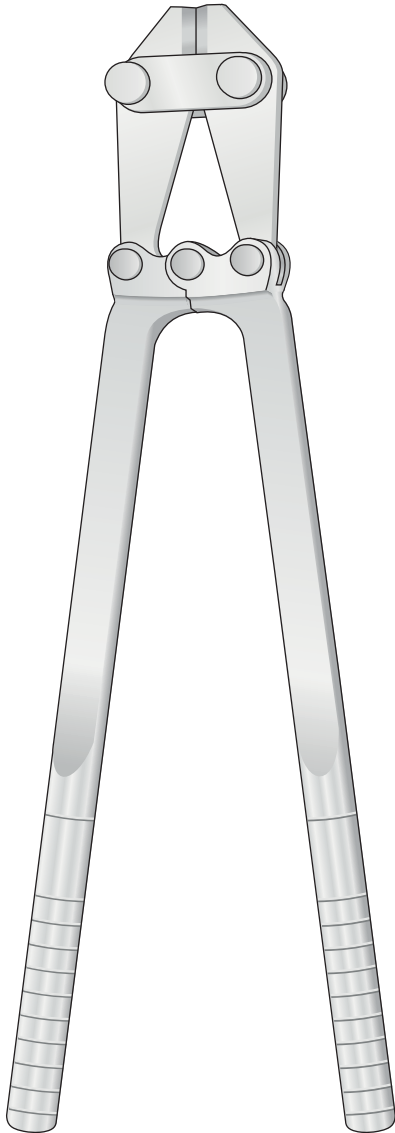
Per filo leggero Ø 2,5 mm  
Per filo duro Ø 2 mm  
For soft wire Ø 2,5 mm  
For hard wire Ø 2 mm  
Für weichen Draht Ø 2,5 mm  
Für harten Draht Ø 2 mm  
Pour fil léger Ø 2,5 mm  
Pour fil dur Ø 2 mm  
Para alambres ligero Ø 2,5 mm  
Para alambres duro Ø 2 mm



**LX-105**  
230 mm

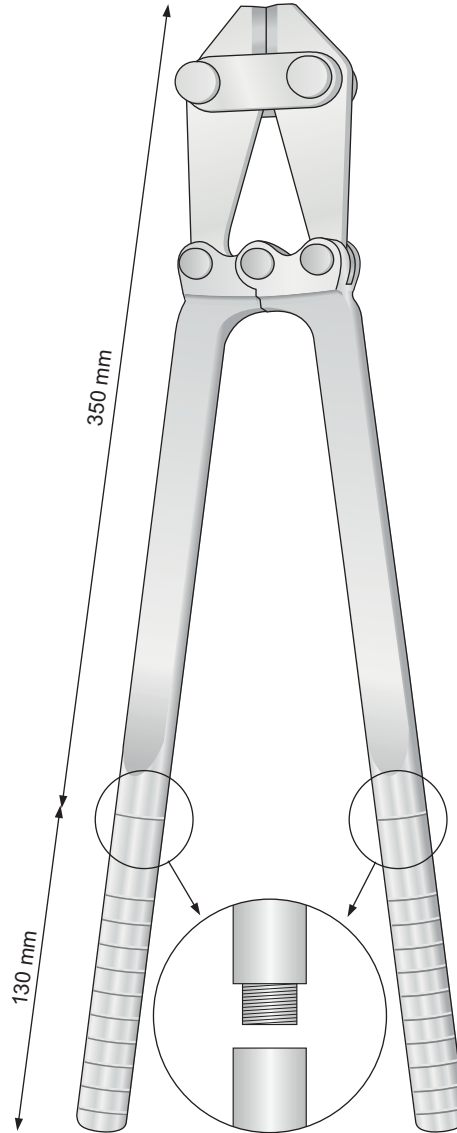


Per filo leggero Ø 7 mm  
Per filo duro Ø 6 mm  
For soft wire Ø 7 mm  
For hard wire Ø 6 mm  
Für weichen Draht Ø 7 mm  
Für harten Draht Ø 6 mm  
Pour fil léger Ø 7 mm  
Pour fil dur Ø 6 mm  
Para alambres ligero Ø 7 mm  
Para alambres duro Ø 6 mm



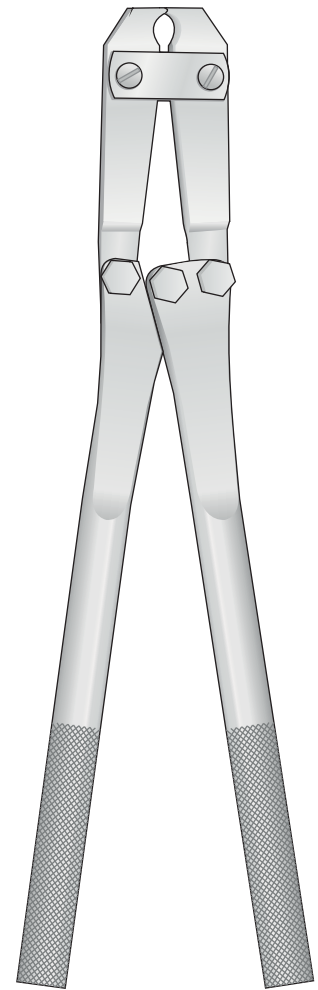
**VF-98**  
480 mm

Per filo leggero Ø 7 mm  
Per filo duro Ø 6 mm  
For soft wire Ø 7 mm  
For hard wire Ø 6 mm  
Für weichen Draht Ø 7 mm  
Für harten Draht Ø 6 mm  
Pour fil léger Ø 7 mm  
Pour fil dur Ø 6 mm  
Para alambres ligero Ø 7 mm  
Para alambres duro Ø 6 mm



**VF-98M**  
480 mm

Per filo leggero Ø 5 mm  
Per filo duro Ø 4,5 mm  
For soft wire Ø 5 mm  
For hard wire Ø 4,5 mm  
Für weichen Draht Ø 5 mm  
Für harten Draht Ø 4,5 mm  
Pour fil léger Ø 5 mm  
Pour fil dur Ø 4,5 mm  
Para alambres ligero Ø 5 mm  
Para alambres duro Ø 4,5 mm



**LX-107**  
375 mm



Misuratore per chiodi Kirschner  
Measuring Gauge for nails  
Meßlehre für Kirschnerdrähte



**KI-10**

0,5 mm



**LS-06**  
300 mm

0,5 mm



**LS-09**  
150 mm

0,5 mm



**LS-08**  
120 mm

0,5 mm



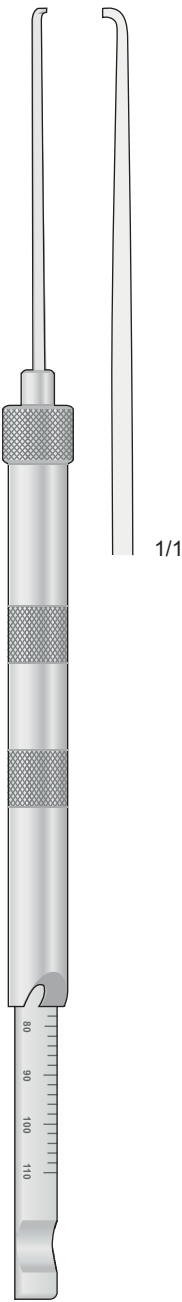
**LS-07**  
50 mm



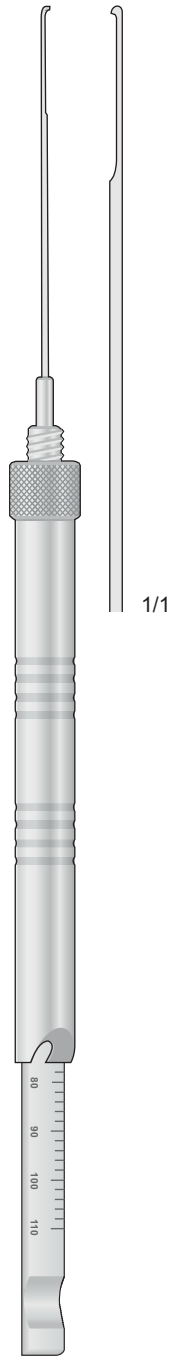
Misuratore di lunghezza per viti  
Screw depth gauges, to select proper length of screw  
Instruments de mesure de profondeur pour déterminer la longueur de vis requise



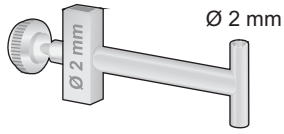
**LS-200**  
165 mm



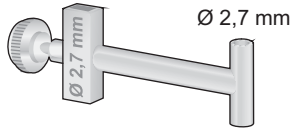
**LS-201**  
265 mm



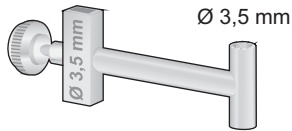
**LS-202**  
280 mm



LS-96

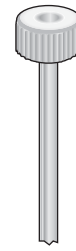


LS-97



LS-98

Centrapunte  
Manicotto dentato  
Steckbohrbüchsen  
Insert-drill

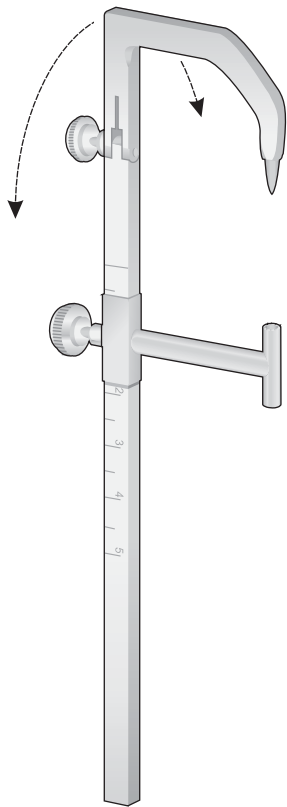


Ø Esterno	Ø Per punte
Ø Outside	Ø For drills
Ø Außen	Ø Für Bohrer
Ø Extérieur	Ø Pour Mèches
Ø Exterior	Ø Para agujas

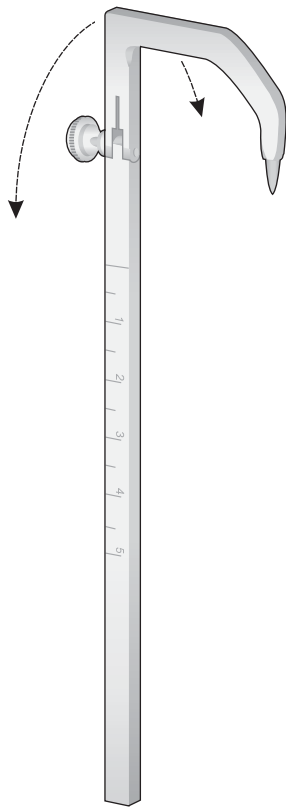
Cod. Art.	Ø Esterno	Ø Per punte
LS-113	4,5 mm	3,2 mm
LS-114	3,5 mm	2 mm
LS-115	3,5 mm	2,7 mm

**LS-95**  
Completo di 3 guide  
Complete with 3 guide  
**LS-94+LS-96+LS-97+LS-98**

**LS-94**  
Centratore solo  
Drill guide only

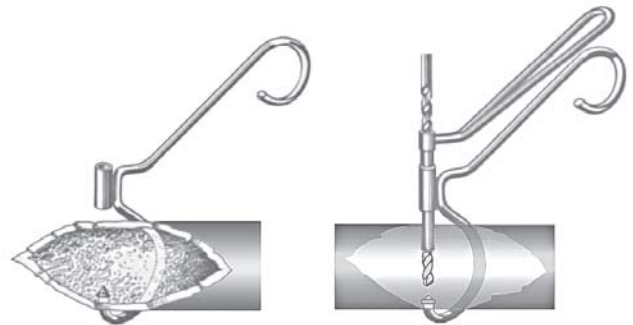


LS-95  
145 mm

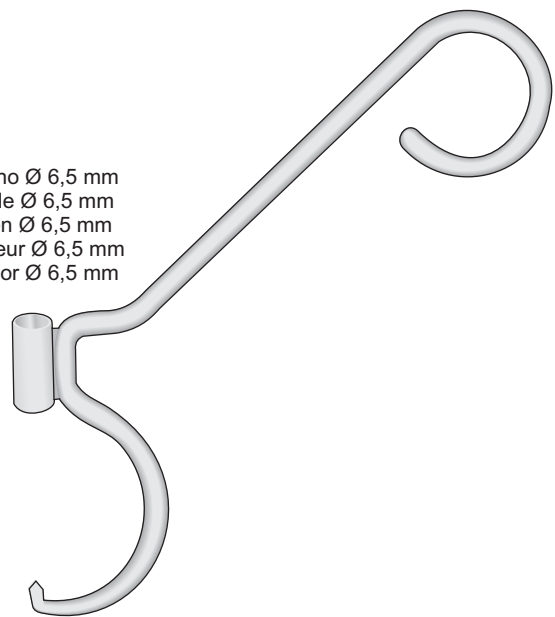


LS-94  
145 mm

Guida per punte elicoidali  
Gewebeschutzhülsen



Interno Ø 6,5 mm  
Inside Ø 6,5 mm  
Innen Ø 6,5 mm  
Intérieur Ø 6,5 mm  
Interior Ø 6,5 mm



LS-112





Attacco Dentale  
Dental schaft

Ø 1,5 mm



**LS-32**  
50 mm

Ø 2,0 mm



**LS-33**  
55 mm

Attacco AO  
Mit AO schaft

Ø 1,5 mm



**LS-10**  
65 mm

Ø 2 mm



**LS-11**  
70 mm

Ø 2,7 mm



**LS-12**  
100 mm

Passo della vite  
a 1,25 mm

Ø 3,5 mm



**LS-13**  
110 mm

Passo della vite  
a 1,75 mm

Ø 3,5 mm



**LS-14**  
110 mm

Ø 4,5 mm



**LS-15**  
130 mm

Ø 4,5 mm



**LS-16**  
130 mm

Ø 6,5 mm

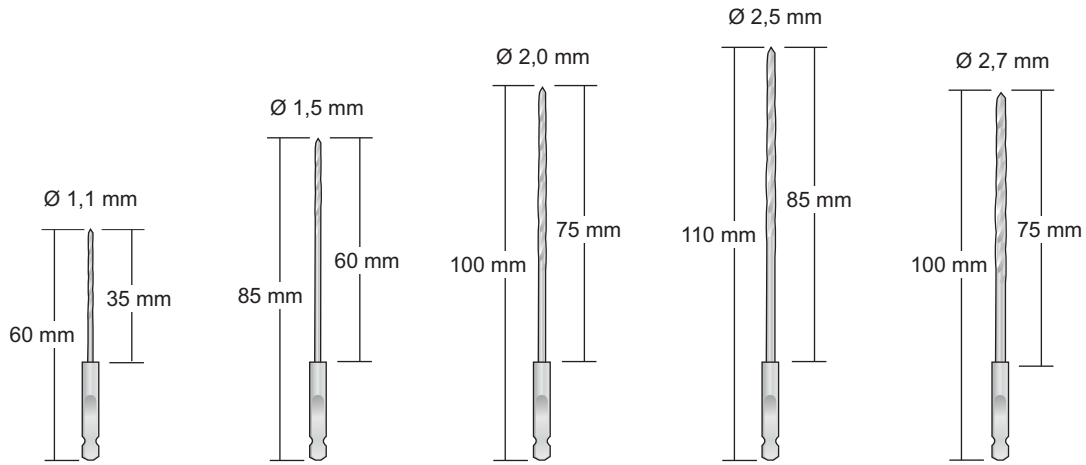


**LS-17**  
170 mm



Punte elicoidali con innesto rapido

Attacco AO  
Mit AO schaft  
Drill bits



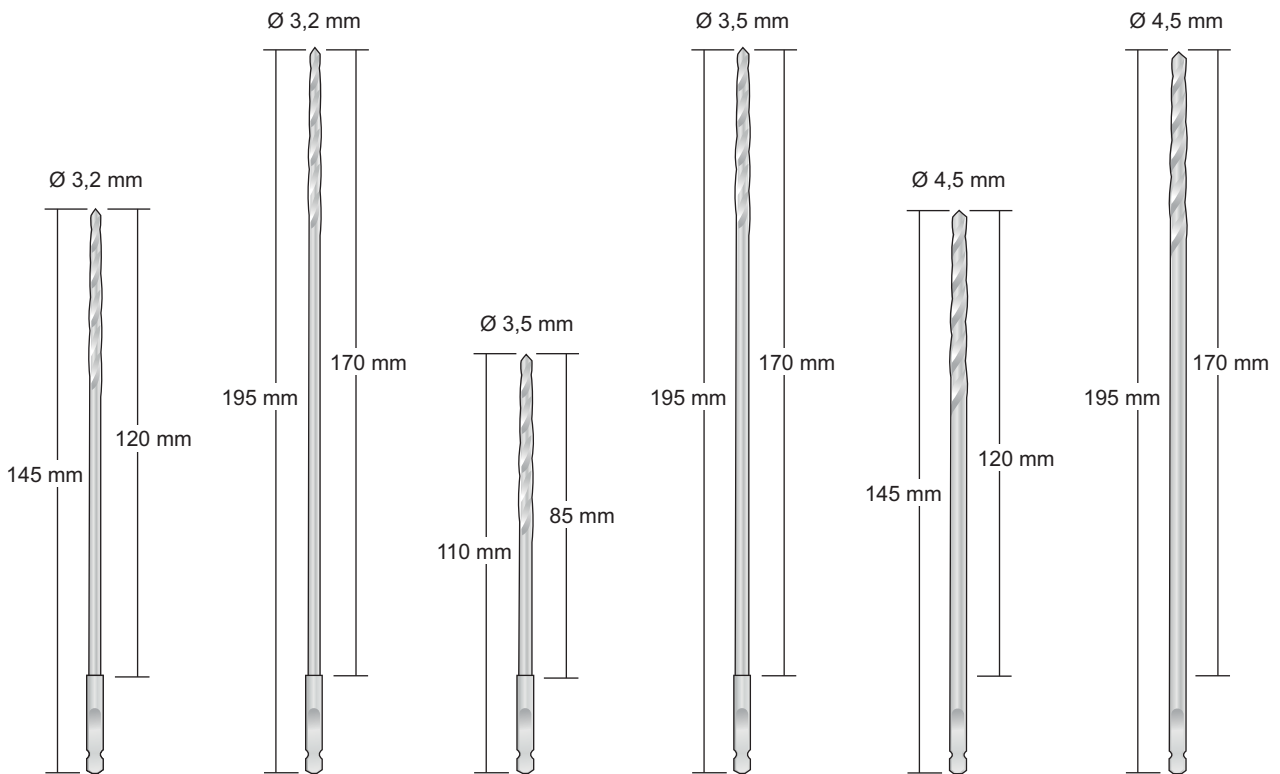
LS-20

LS-21

LS-22

LS-23

LS-24



LS-25

LS-26

LS-27

LS-28

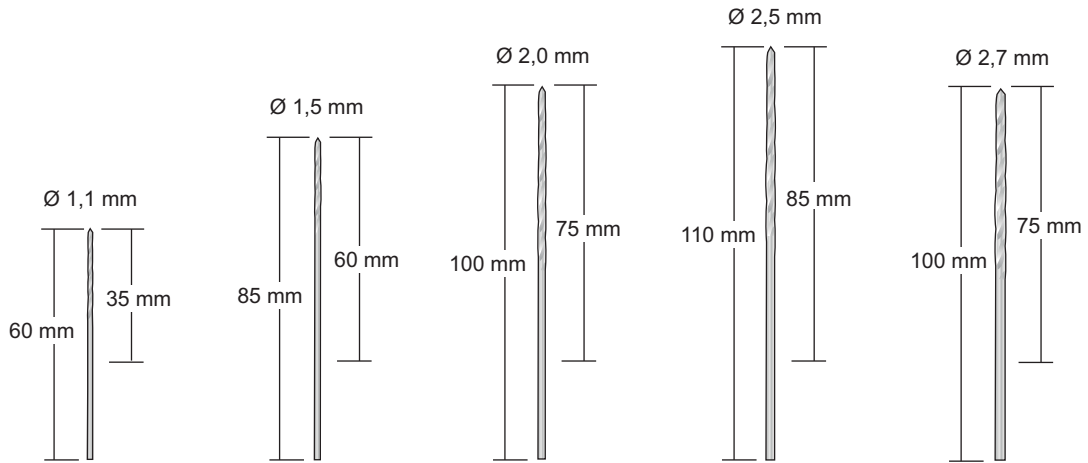
LS-29

LS-30



Punte elicoidali

Con attacco rotondo  
Mit rundschaft  
Drill bits



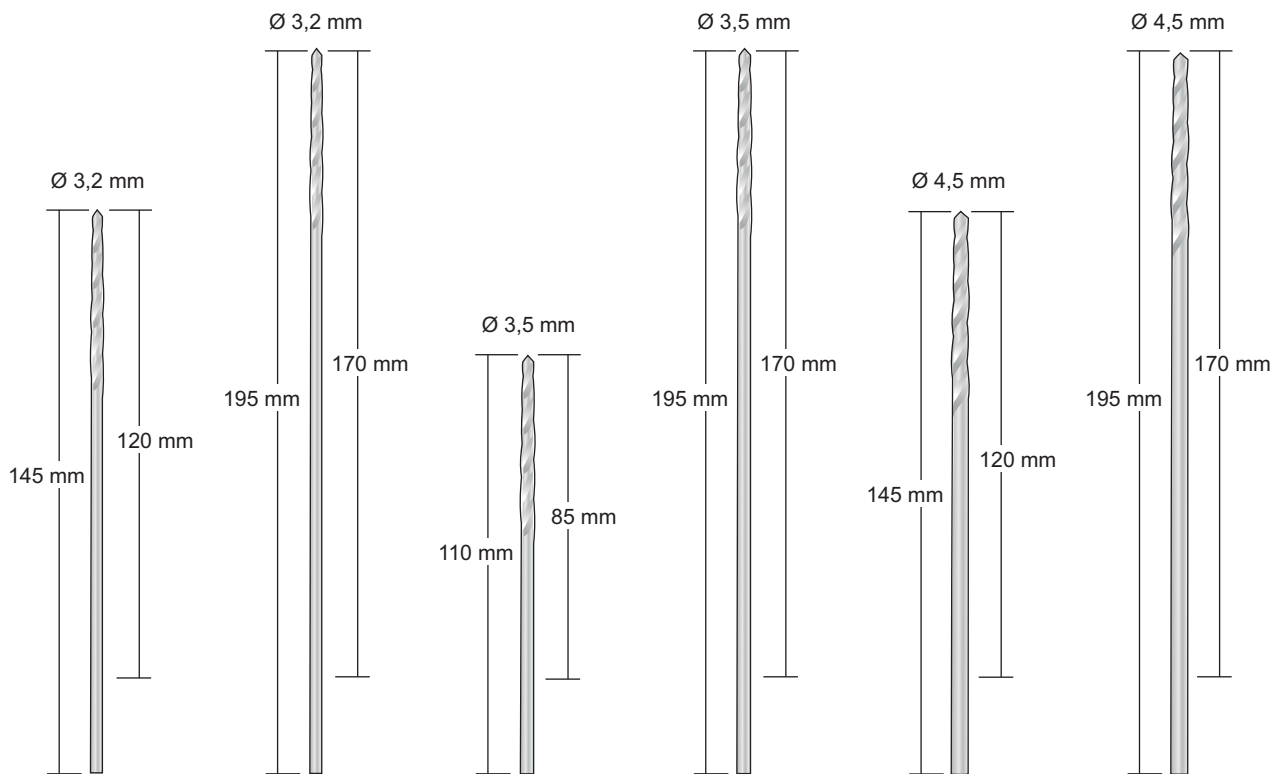
LS-40

LS-41

LS-42

LS-43

LS-44



LS-45

LS-46

LS-47

LS-48

LS-49

LS-50



Per mini viti  
For mini-screws  
Für Mini-Schrauben  
Pour mini vis

1,5 mm



2/3

**LS-135**  
55 mm

1,1 mm



2/3

**LS-136**  
55 mm

Per piccole viti  
For small screws  
Für kleine Schrauben  
Pour petite vis

2,0 mm



2/3

**LS-137**  
70 mm

Per viti malleolari  
For malleolar screws  
Für Malleolarschrauben  
Pour vis à malléole

3,2 mm



2/3

**LS-138**  
120 mm

2,5 mm



2/3

**LS-125**  
100 mm

3,5 mm



2/3

**LS-126**  
90 mm

Reamer with end forquick coupling  
Zapfenfräser mit Schnellkupplung  
Fraise avec raccord rapide

Ø 4,5 mm



Ø 8 mm

3 Kant

2/3

**LS-139**  
90 mm



Ø 8 mm

2/3

**LS-140**  
90 mm



Manico con mandrino rapido  
Handles with quick-action chuck  
Handgriffe mit schnellspann futter  
Poignées avec mandrins rapides

Ø 4 mm

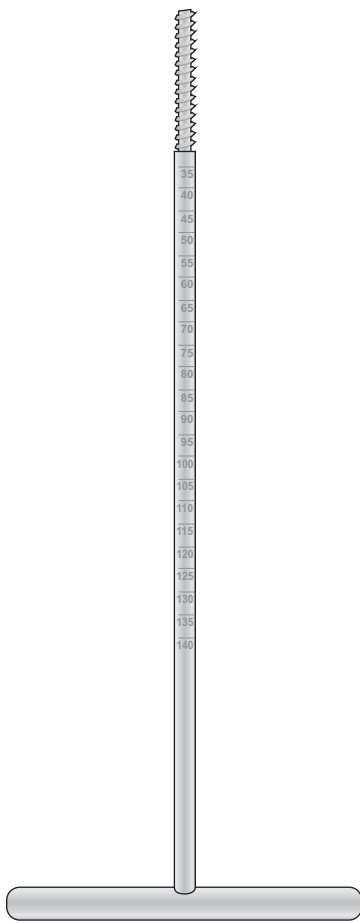
AO-Schaft



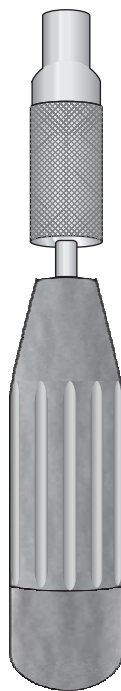
Dental-Schaft



4kant-Schaft



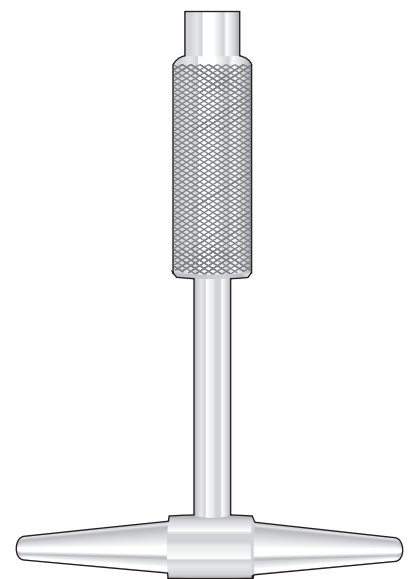
**LS-120**  
260 mm



**MANICO FERROZELL  
LS-242**  
125 mm



**LS-244**  
110 mm

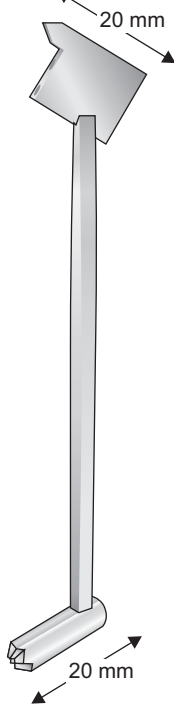


**LS-240**  
80 mm



Centratori guida punte - Drill guides - Bohrbüchsen zu Knochenplatten - Guide méche

Per trapano Ø 2 mm



**LS-80**  
110 mm

Per viti da corticale Ø 3,5 mm  
Per maschiatore Ø 2,5 mm



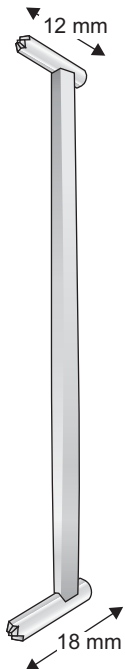
**LS-81**

Per viti da corticale  
Ø 6,5 mm  
Per maschiatore  
Ø 3,2 mm



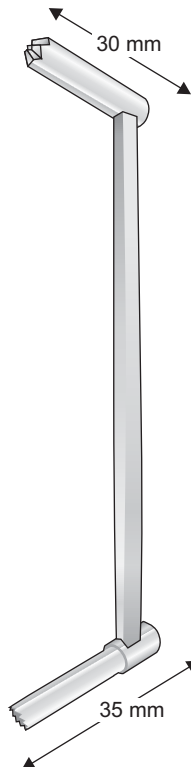
**LS-82**

Per trapano Ø 1,1/1,5 mm



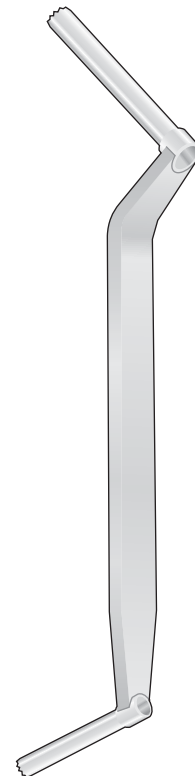
**LS-83**  
105 mm

Per trapano Ø 2,5 mm  
Per viti da corticale Ø 3,5 mm  
Per maschiatore Ø 3,5 mm



**LS-84**  
125 mm

Per viti da corticale Ø 4,5 mm  
Per maschiatore Ø 3,2 mm



**LS-85**

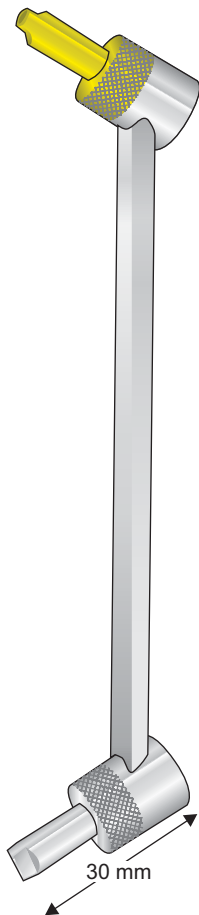


Centratori guida punte - Drill guides - Bohrbüchsen zu Knochenplatten - Guide méche

**Codificazione del colore**

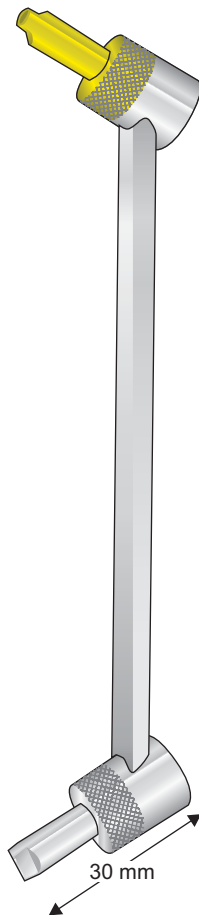
verde = centrico  
oro = eccentrico

Per trapano Ø 2,0 mm  
Per viti da corticale Ø 2,7 mm



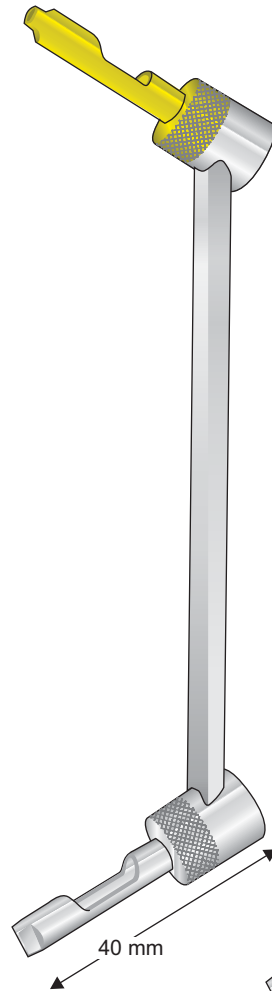
**LS-91**  
140 mm

Per trapano Ø 2,5 mm  
Per viti da corticale Ø 3,5 mm



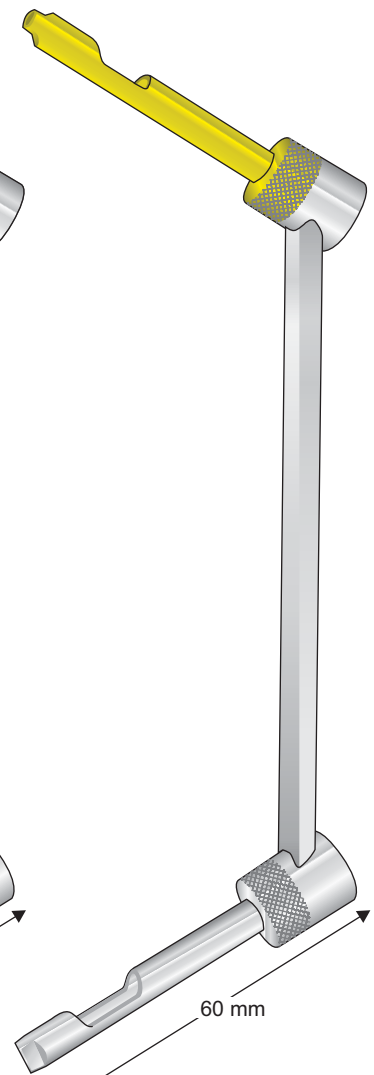
**LS-90**  
140 mm

Per trapano Ø 3,2 mm  
Per viti da corticale Ø 4,5 mm



**LS-92**  
165 mm

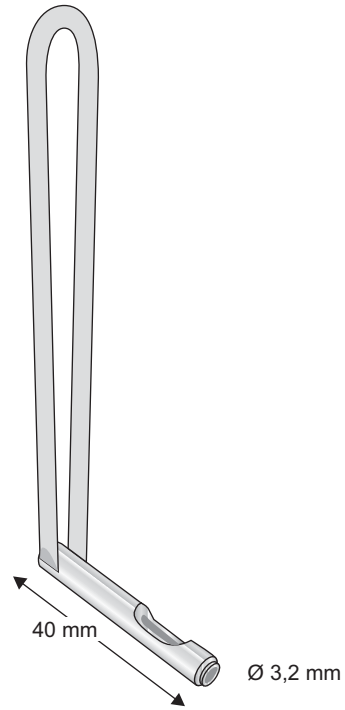
Per trapano Ø 3,2 mm  
Per viti da corticale Ø 4,5 mm



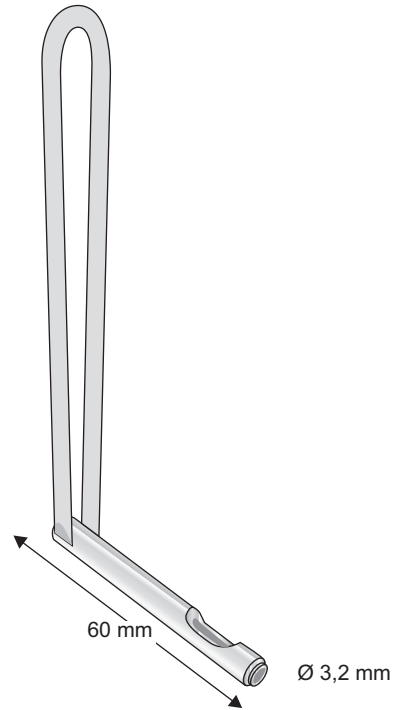
**LS-93**  
170 mm



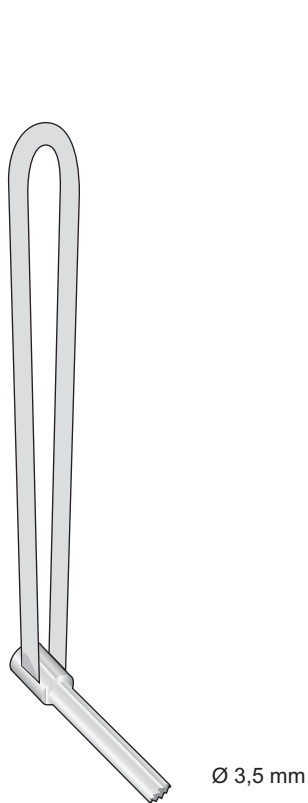
Centratori guida punte - Drill guides - Bohrbüchsen zu Knochenplatten - Guide méche



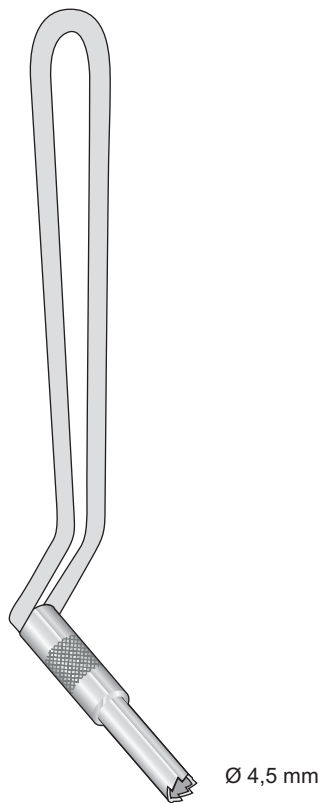
**LS-117**  
125 mm



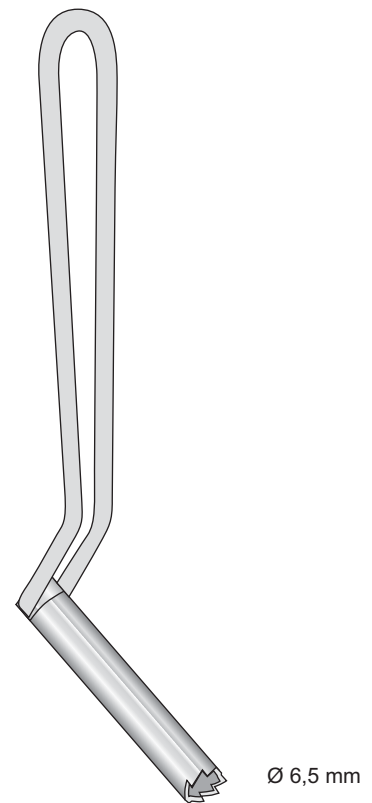
**LS-124**  
125 mm



**LS-116**  
125 mm



**LS-119**  
150 mm

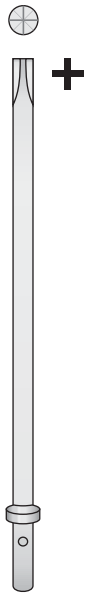


**LS-121**  
150 mm

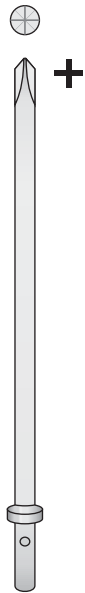




Scatola con set giraviti - Box with screws driver - Schraubenzieher, Set mit Etui  
Jeu de tournevis, en boîte - Set destornilladores



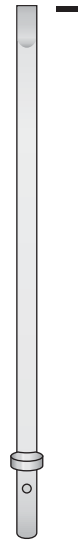
**LS-321**  
140 mm



**LS-322**  
140 mm

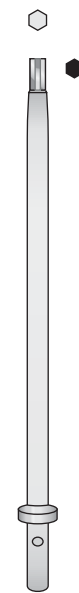


**LS-323**  
140 mm



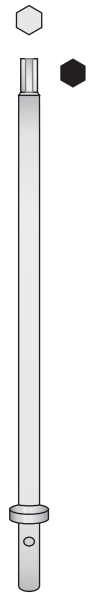
**LS-324**  
140 mm

2,5 mm

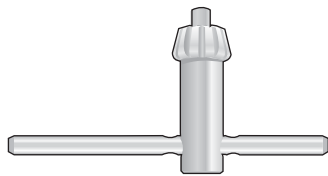


**LS-325**  
140 mm

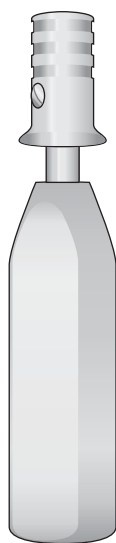
3,5 mm



**LS-326**  
140 mm

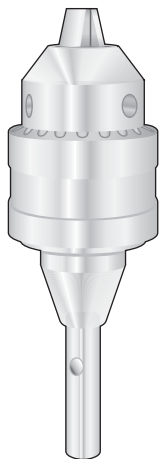


**LS-231**  
32 mm



**LS-320**  
145 mm

Max. Ø 6,3 mm

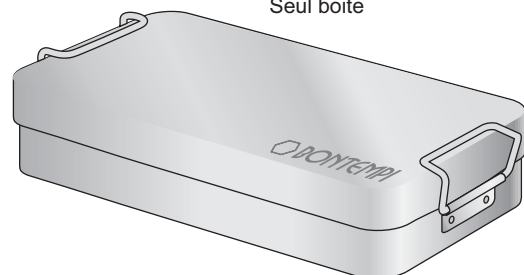


**UNIVERSAL  
LS-235**  
75 mm

**LS-330**

Scatola con set giraviti - Completo  
Box with screws driver - Complete  
Schraubenzieher, Set mit Etui - Komplett  
Jeu de tournevis, en boîte - Complete  
Set destornilladores - Completos

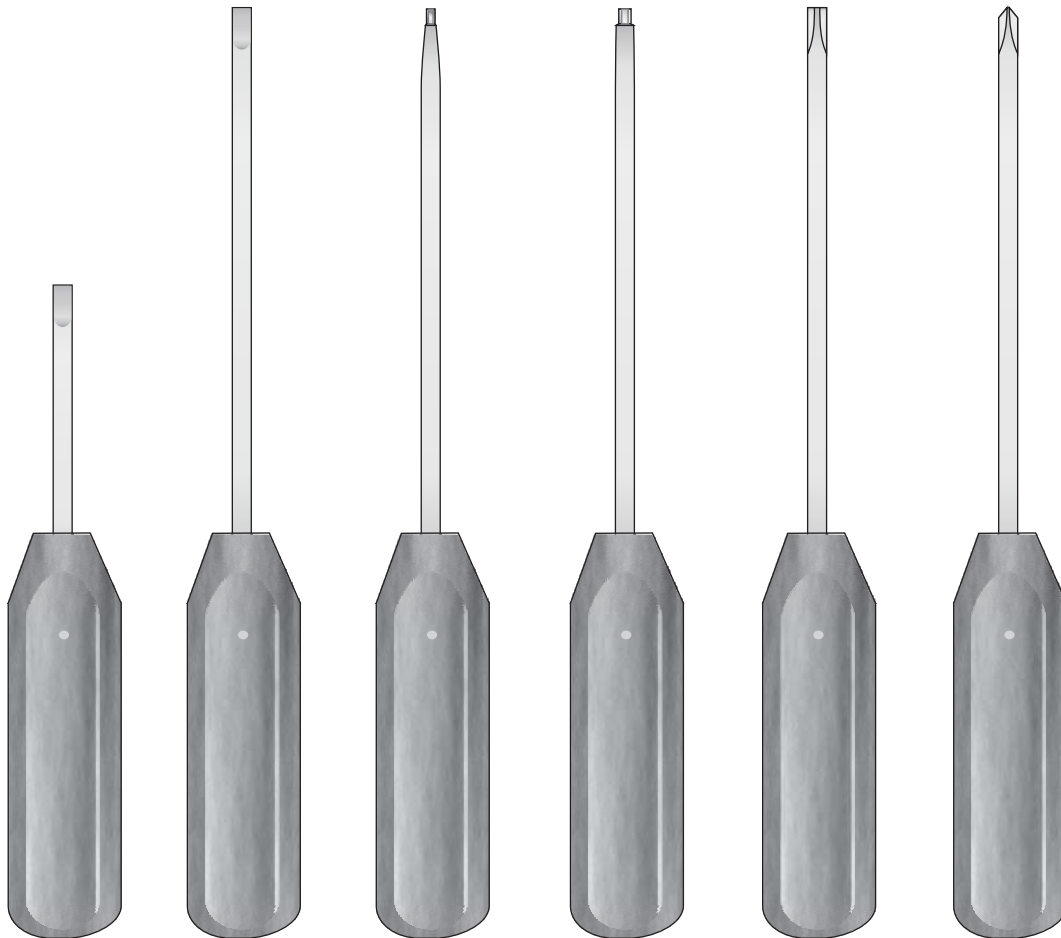
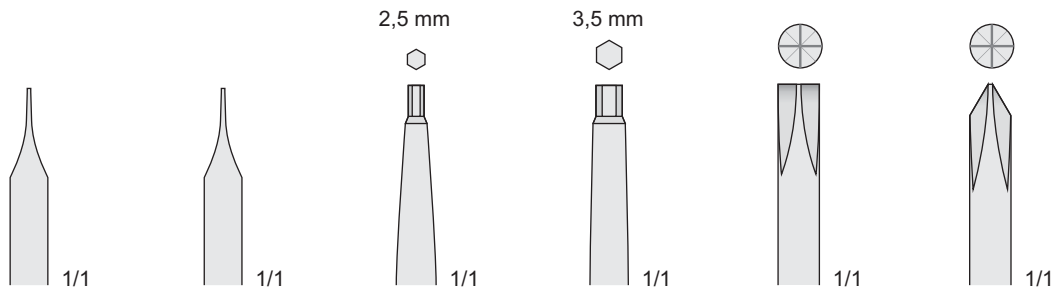
Solo scatola  
Box only  
Etui allein  
Seul boîte



**LS-329**  
200x100x40 mm



Giraviti con manico di Ferrozell  
Screws driver with Ferrozell handle  
Schraubenzieher mit Ferrozellgriff  
Jeu de tournevis avec poignée en Ferrozell  
Destornilladores con mango de Ferrozell



**LS-310**  
170 mm

**LANE LS-311**  
250 mm

**LS-312**  
250 mm

**LS-313**  
250 mm

**LS-314**  
250 mm

**PHILIPS LS-315**  
250 mm



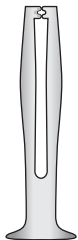
Giraviti con manico di Ferrozell  
Screws driver with Ferrozell handle  
Schraubenzieher mit Ferrozellgriff  
Jeu de tournevis avec poignée en Ferrozell  
Destornilladores con mango de Ferrozell

1,5 mm



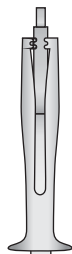
**LS-127**  
35 mm

2,5 mm



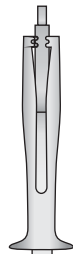
**LS-128**  
50 mm

+ 1,5-2,5 mm



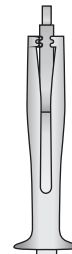
**LS-316**  
195 mm

○ 1,5 mm



**LS-317**  
195 mm

○ 2,5 mm



**LS-318**  
195 mm



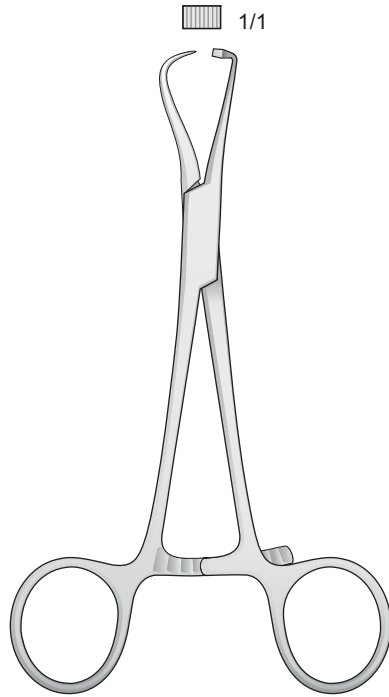
Pinze e chiavi  
per placche

Biege und  
schränkhebel

Forceps  
for plattes

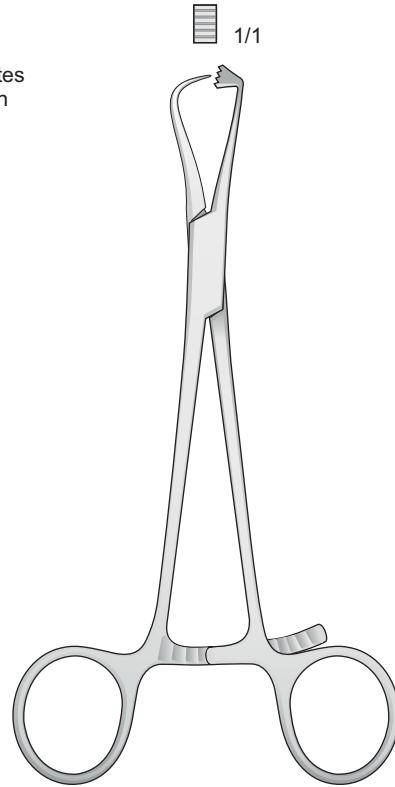
Pinces à courber  
pour plaques

Pinzas  
para placas



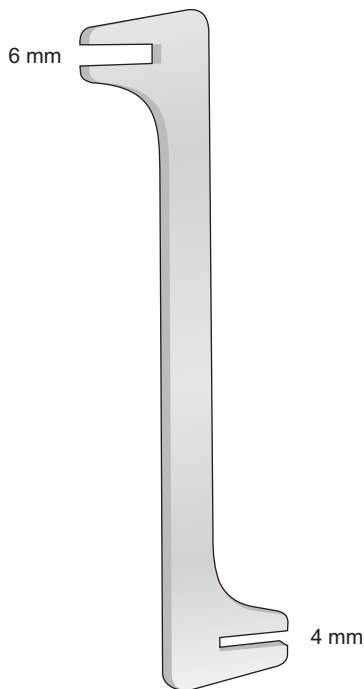
**LS-76**  
120 mm

Holding forceps for plates  
Haltezange für platten



**LS-78**  
125 mm

For standard plates  
Für Standard-Platten



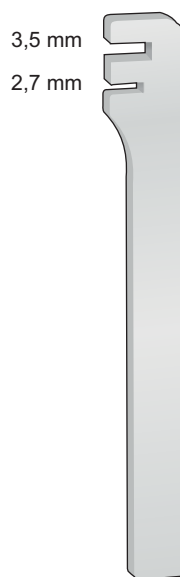
**LS-101**  
180 mm

Bending irons, for small plates  
Biege und Schränkhebel für kleine platten

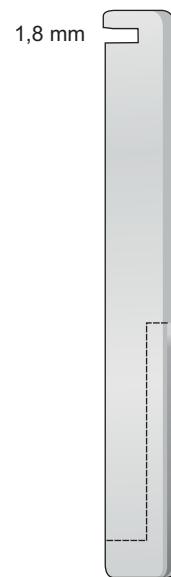
Per placche da  
2,7 mm e 3,5 mm



**LS-103** 100 mm  
**LS-102** 140 mm



**LS-123** 100 mm  
**LS-122** 140 mm



**LS-104**  
100 mm



Pinze  
per placche

Zangen für  
schränkhebel platten

Forceps  
for plattes

Pinces à courber  
pour plaques

Pinzas  
para placas

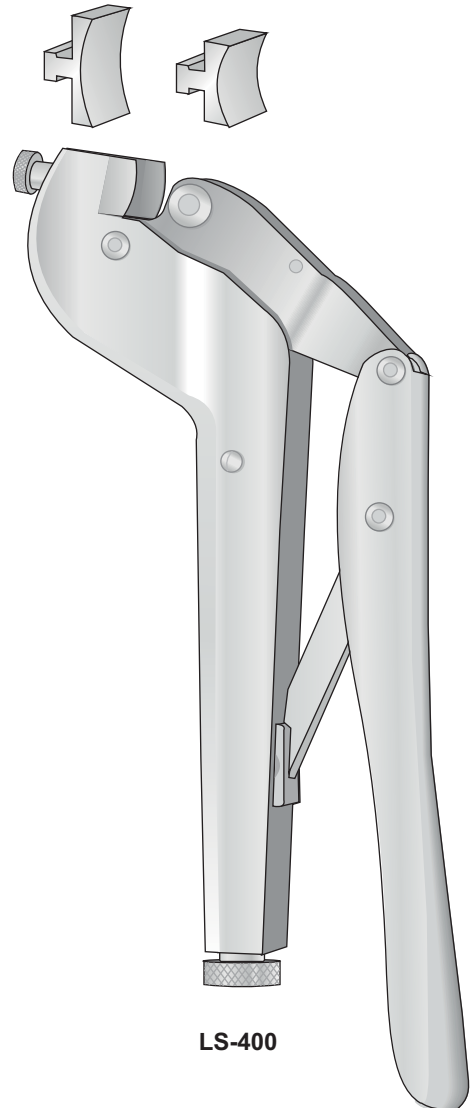
Pinze piegaplacche - Bending pliers - Biegezange - Pinces à plier



**LS-405**  
200 mm

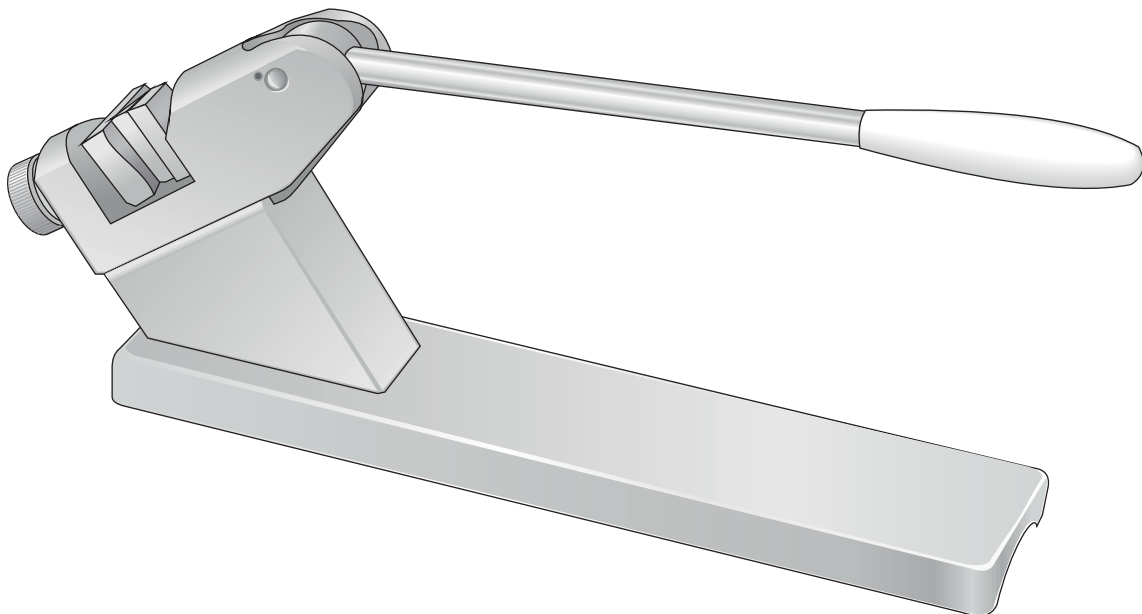


**LS-406**  
240 mm



**LS-400**

Pressa piegaplacche - Bending press - Biegepresse - Presse pour plier



**LS-410**



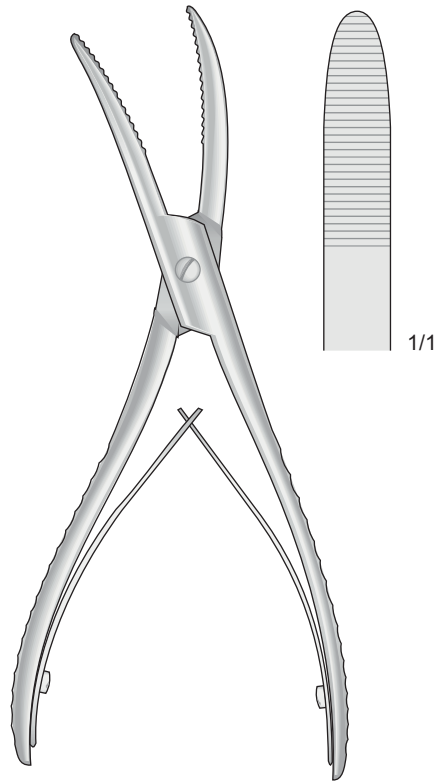
Strumenti  
per gesso

Plaster spreader  
Plaster cast breakers

Gipsspreizer  
Gipsabreisszangen

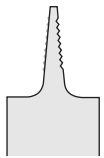
Pinces pour  
appareils plâtrés

Pinza para  
arrancar vendajes

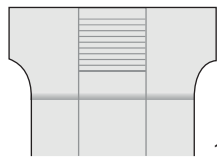


1/1

WOLFF  
**LX-113**  
180 mm



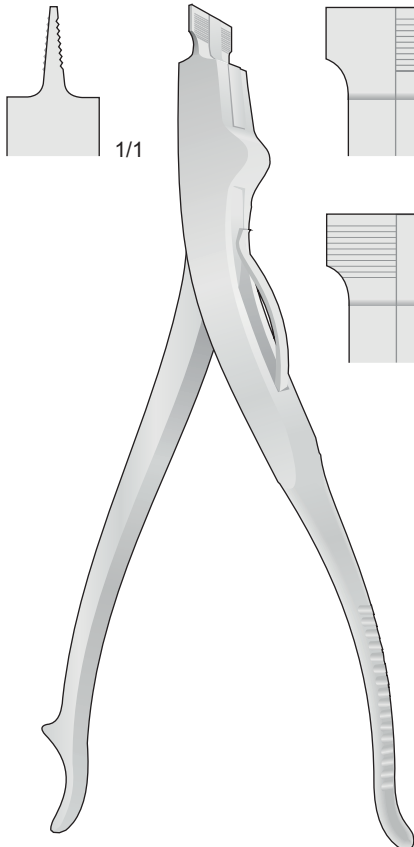
1/1



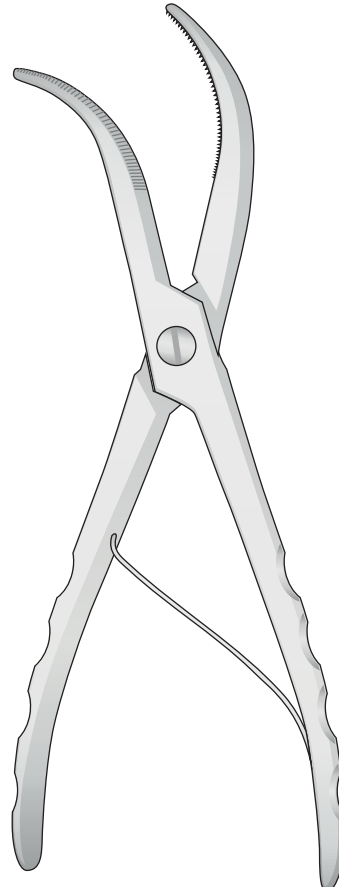
1/1



1/1



**LX-115**  
220 mm

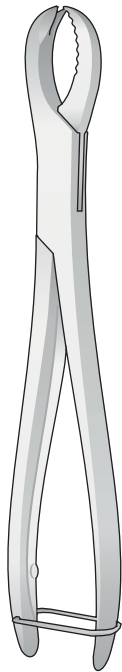


1/1

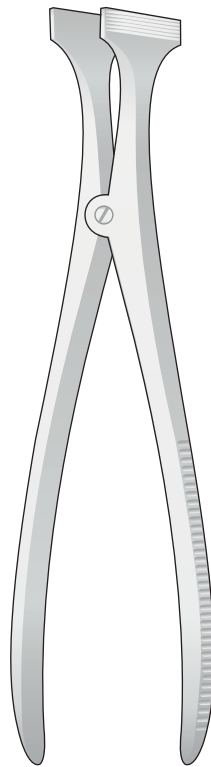
WOLFF  
**LX-114**  
250 mm



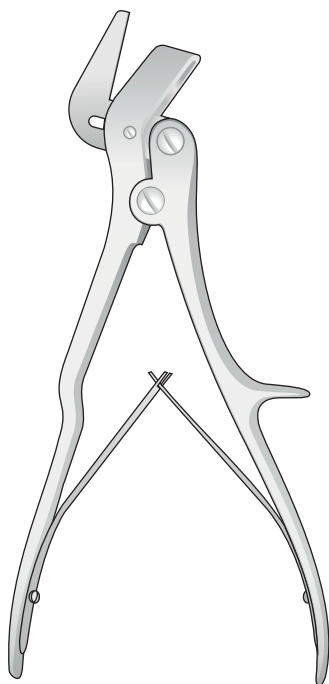
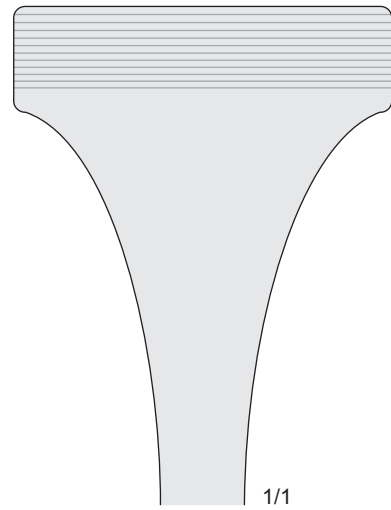
Cesoie per gesso  
Gips - Schneidezangen



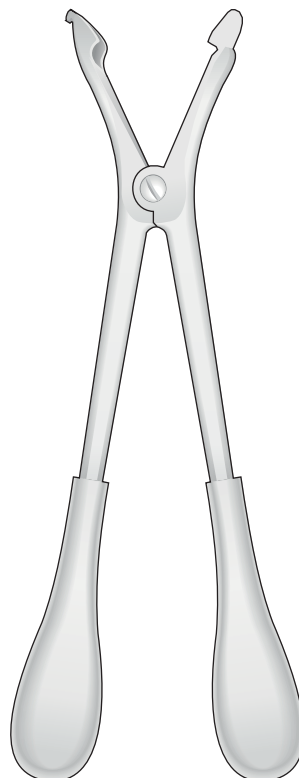
**BK-30**  
210 mm



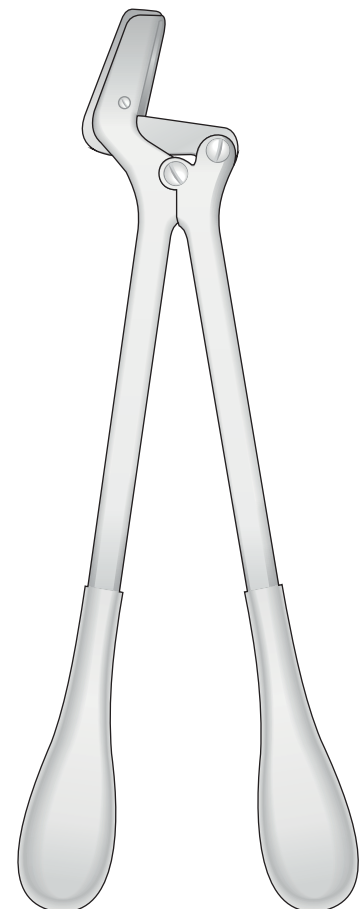
**HENNIG  
LX-123**  
270 mm



**STILLE  
LX-120**  
230 mm



**HAGLUND  
LX-121**  
280 mm



**STILLE  
LX-122**  
370 mm







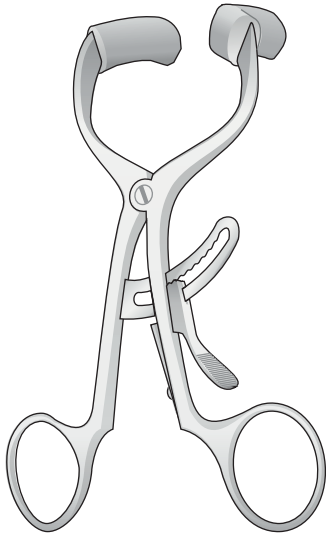
14

O.R.L. - H.N.O. - E.N.T.  
O.R.L. - H.N.O. - E.N.T.  
O.R.L. - H.N.O. - E.N.T.  
O.R.L. - H.N.O. - E.N.T.  
O.R.L. - H.N.O. - E.N.T.



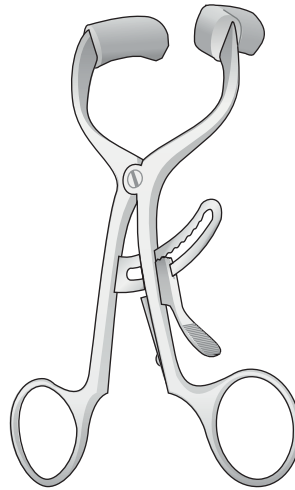


Per adulti - For adults  
Für Erwachsene - Pour adultes  
Para adultos



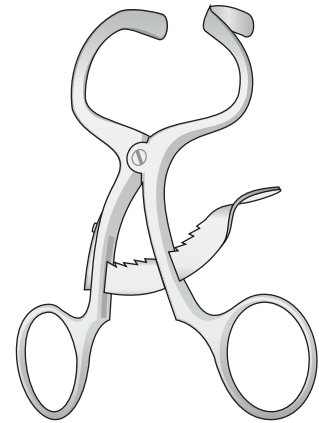
DOYEN-JANSEN  
**OM-41**  
140 mm

Per adulti - For adults  
Für Erwachsene - Pour adultes  
Para adultos

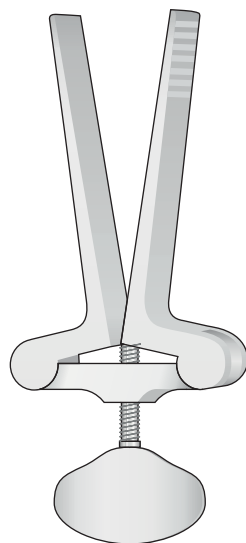


DOYEN-COLLIN  
**OM-40**  
120 mm

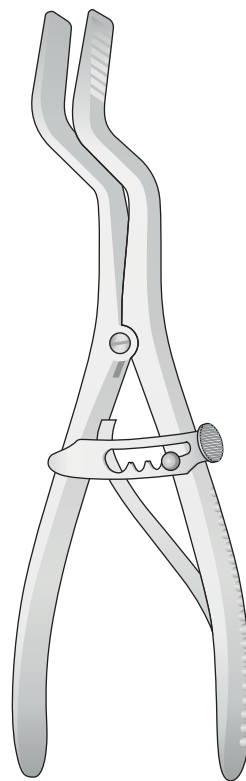
Per bambini  
For children  
Für kinder  
Pour enfants  
Para niños



MOLT  
**OM-42**  
100 mm



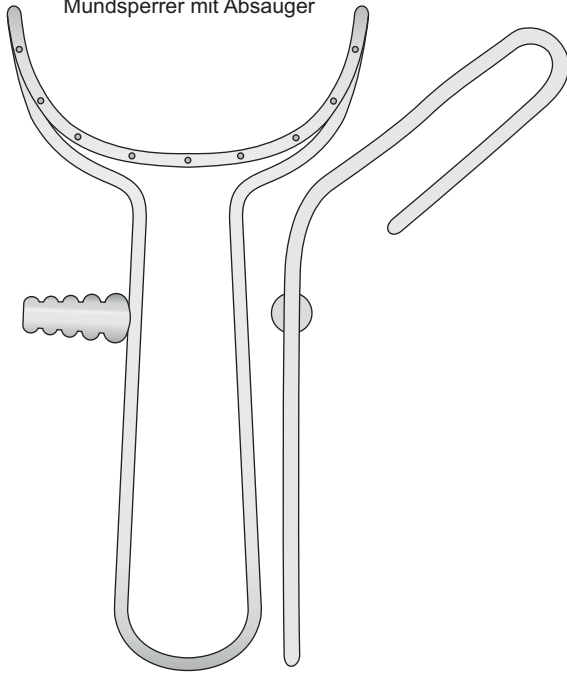
HEISTER  
**OM-62**  
135 mm



ROSER KÖNIG  
**OM-60**  
185 mm

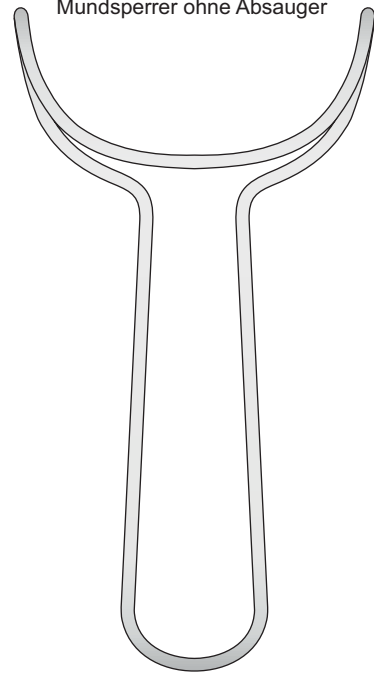


Apribocca con aspirazione  
Mouth gag with suction  
Mundsperrer mit Absauger

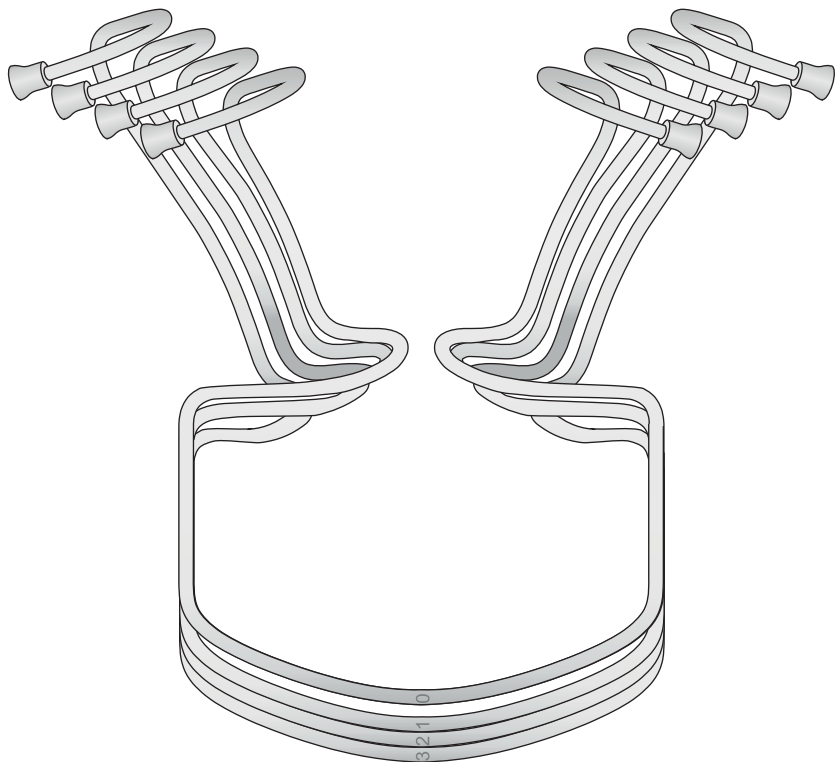
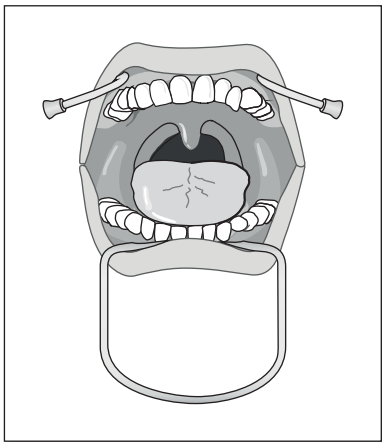


**OM-92**  
140 mm

Apribocca senza aspirazione  
Mouth gag without suction  
Mundsperrer ohne Absauger

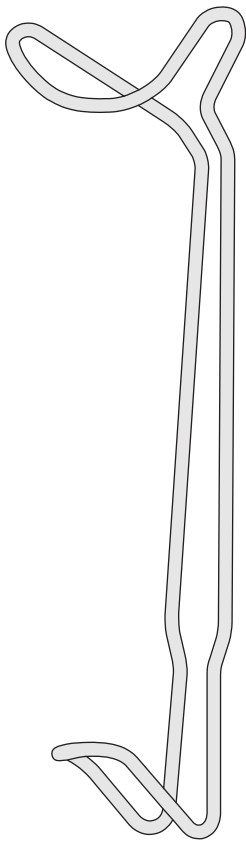


**OM-90**  
150 mm

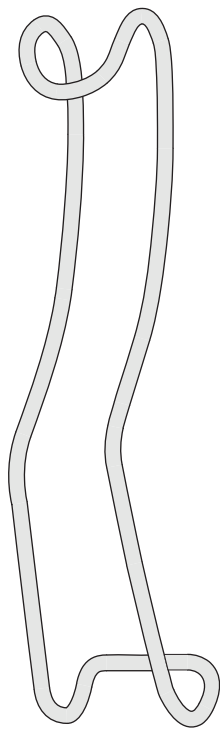


ORINGER

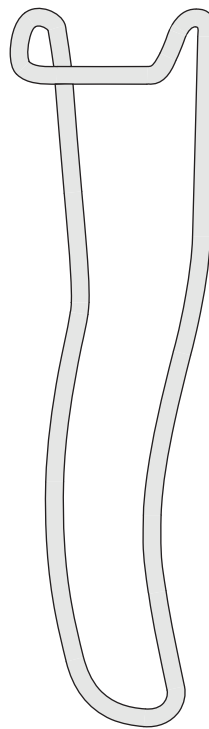
- OM-74** Fig. 0 100 x 95 mm Per bambini
- OM-75** Fig. 1 115 x 105 mm Per adulti
- OM-76** Fig. 2 115 x 110 mm Per adulti
- OM-77** Fig. 3 125 x 115 mm Per adulti



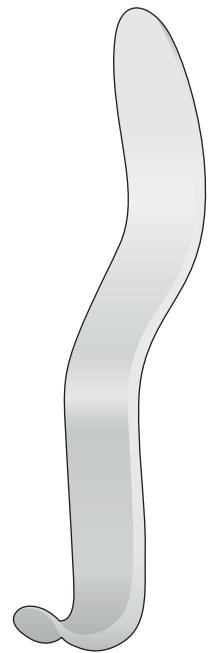
**OM-58**  
210 mm



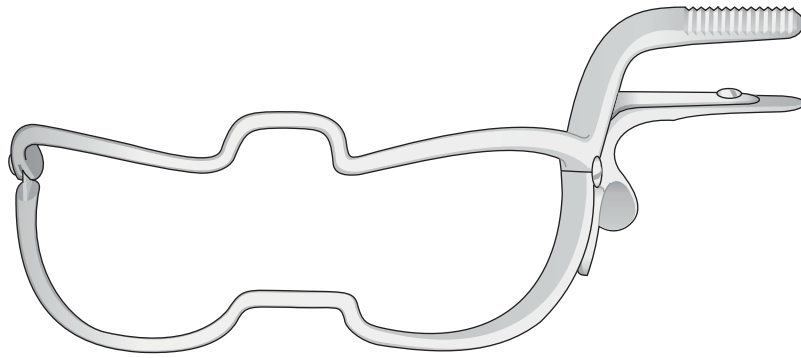
STERNBERG  
**OM-50**  
160 mm



STERNBERG  
**OM-52**  
160 mm



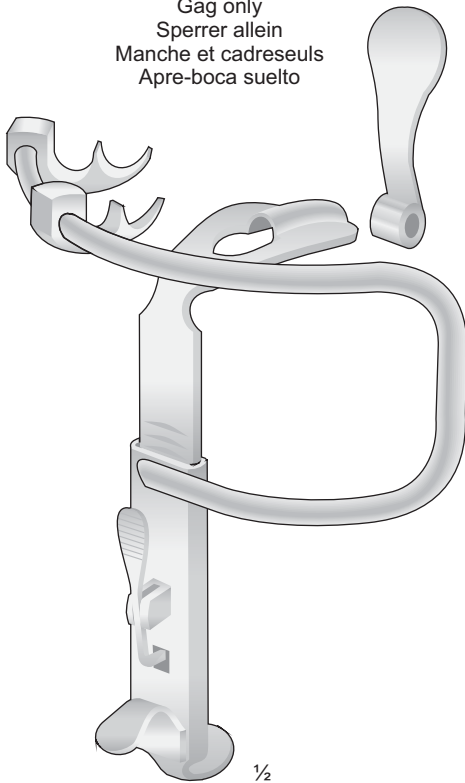
MINNESOTA  
**OM-55**  
140 mm



WHITEHEAD-JENNINGS

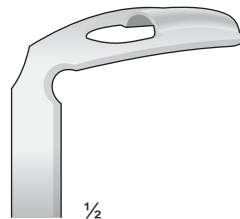
- OM-136** 90 mm
- OM-137** 110 mm
- OM-138** 130 mm
- OM-139** 150 mm

Apribocca solo  
 Gag only  
 Sperrer allein  
 Manche et cadreseuls  
 Apre-boca suelto



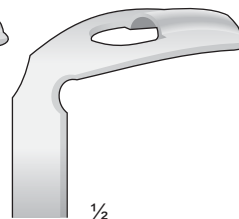
KILNER-DOUGHTY  
**OM-161**

Fig. 1



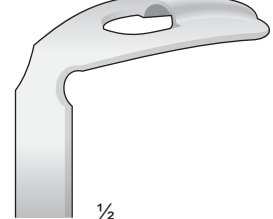
**OM-162**  
 28 x 65 mm

Fig. 2



**OM-163**  
 32 x 75 mm

Fig. 3

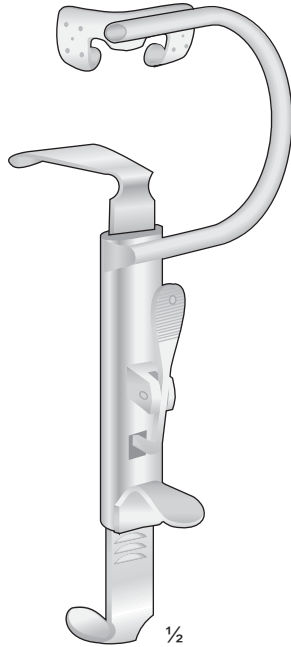


**OM-164**  
 37 x 80 mm

KILNER-DOUGHTY  
**OM-160**  
 Completo con 3 abbassalingua  
 Complete with 3 tongue depressors  
 Komplet mit 3 Zungenspatel  
 Complet avec 3 abaisse-langues  
 Completo con 3 abaja lengua



Apribocca solo  
Gag only  
Sperrer allein  
Manche et cadreseuls  
Apre-boca suelto



DAVIS-BOYLE  
OM-141

DAVIS-BOYLE  
**OM-140**  
Completo con 5 abbassalingua  
Complete with 5 tongue depressors  
Komplet mit 5 Zungenspatel  
Complet avec 5 abaisse-langues  
Completo con 5 abaja lengua



OM-146  
26 x 108 mm



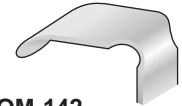
OM-145  
25 x 93 mm



OM-144  
24 x 80 mm

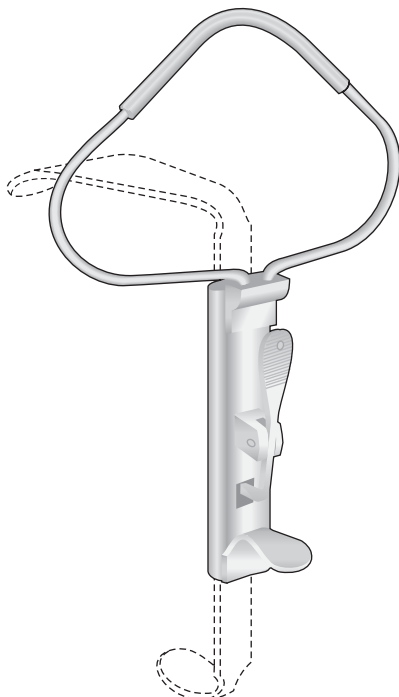


OM-143  
23 x 65 mm



OM-142  
21 x 30 mm

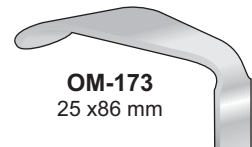
Mc-IVOR  
**OM-170**  
Completo di 3 abbassalingua  
Complete with 3 tongue depressors  
Komplet mit 3 Zungenspatel  
Complet avec 3 abaisse-langues  
Completo con 3 abaja lengua



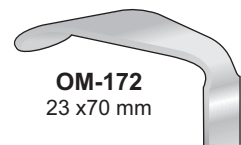
Mc-IVOR  
OM-171



OM-174  
26 x 100 mm



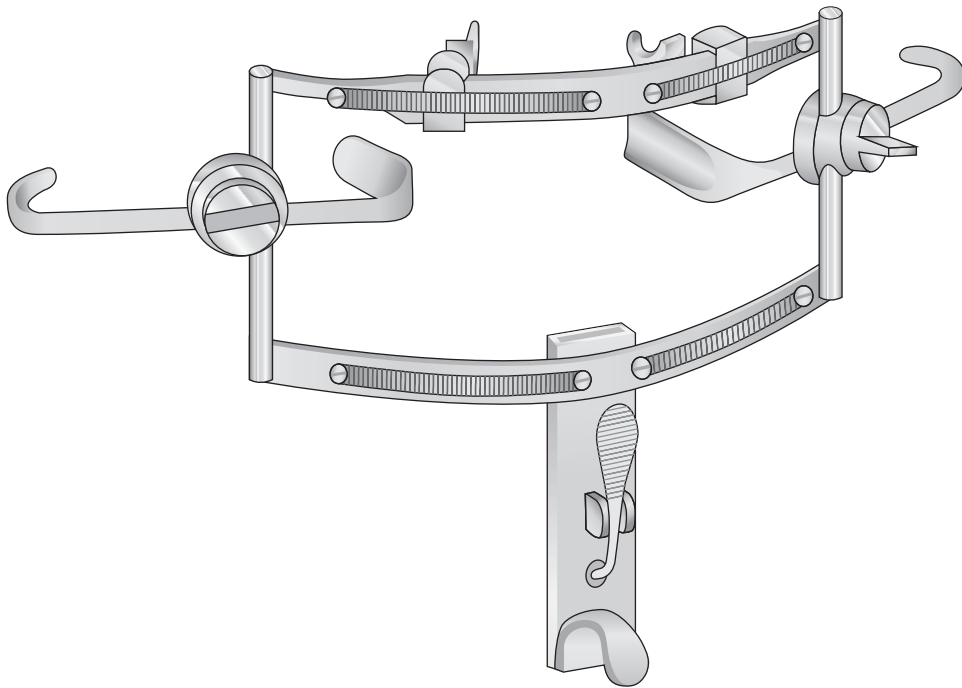
OM-173  
25 x 86 mm



OM-172  
23 x 70 mm



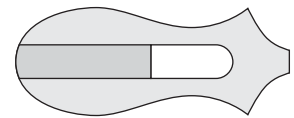
Telaio Dingmann con  
due apriguancia



**OM-111**

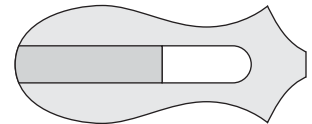
Abbassalingua  
Tongue depressor  
Zungenspatel  
Abaisse langues  
Bejalenguas

Fig. 1



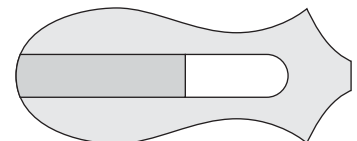
**OM-112**  
piccolo

Fig. 2

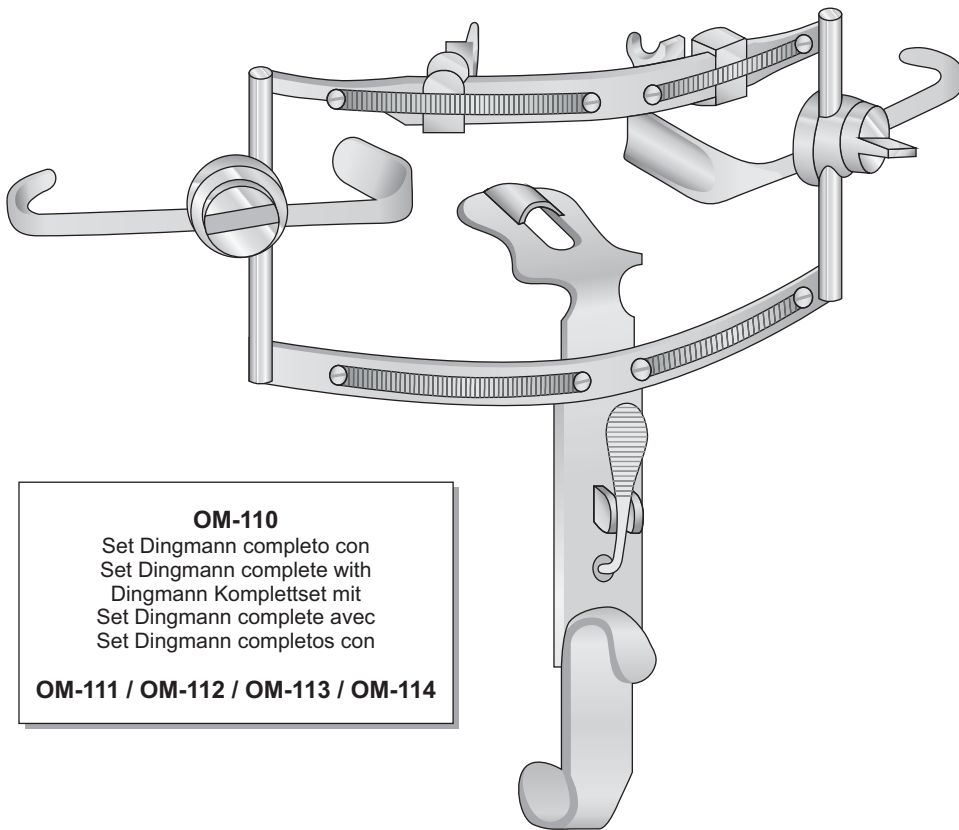


**OM-113**  
medio

Fig. 3



**OM-114**  
grande



**OM-110**

Set Dingmann completo con  
Set Dingmann complete with  
Dingmann Kompletset mit  
Set Dingmann complete avec  
Set Dingmann completos con

**OM-111 / OM-112 / OM-113 / OM-114**

DINGMANN  
**OM-110**  
Set completo





Spatole malleabili

Spatulas malleable

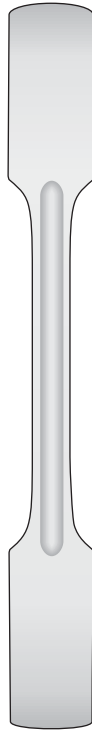
Biegsame Spatel

Spatules flexible

Espatulas flexible



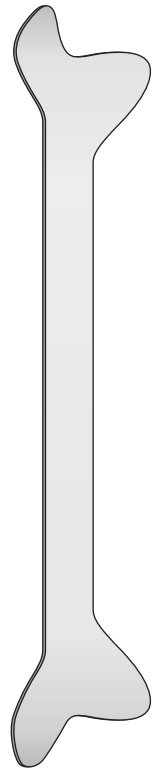
**DS-01**  
110 mm



**DS-02**  
160 mm



**OM-98**  
195 mm



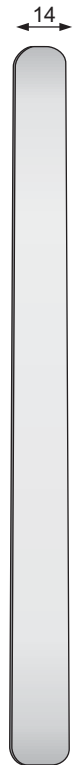
**OM-100**  
180 mm

Spatole inox malleabili  
Spatulas malleable

Spatole Inox malleabili antiriflesso nere  
Spatulas malleable black anodized



**OM-80**  
200 mm



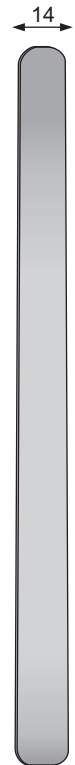
**OM-81**  
200 mm



**OM-82**  
240 mm



**OM-87**  
200 mm



**OM-88**  
200 mm

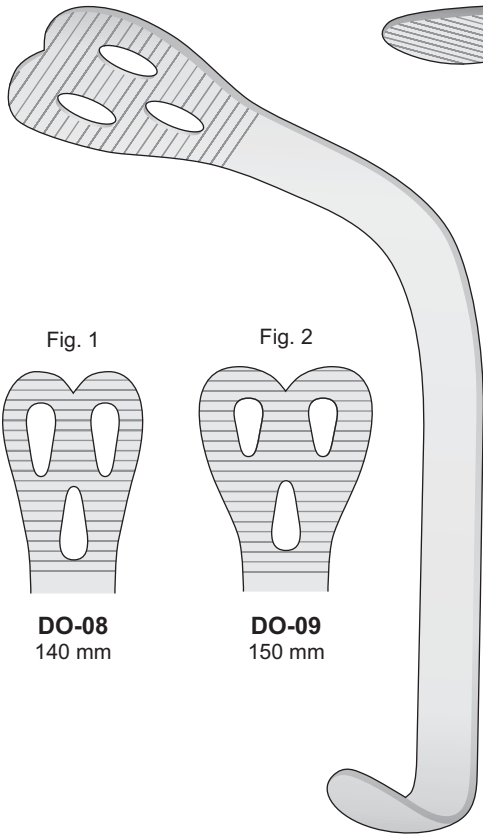
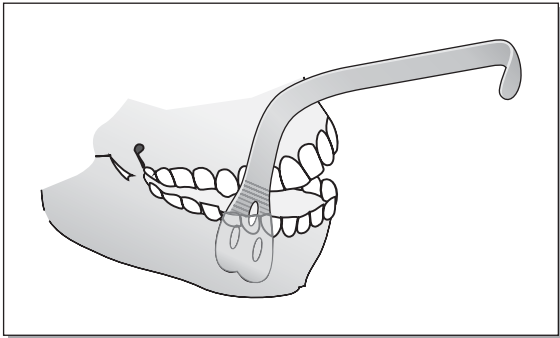


Fig. 1

Fig. 2

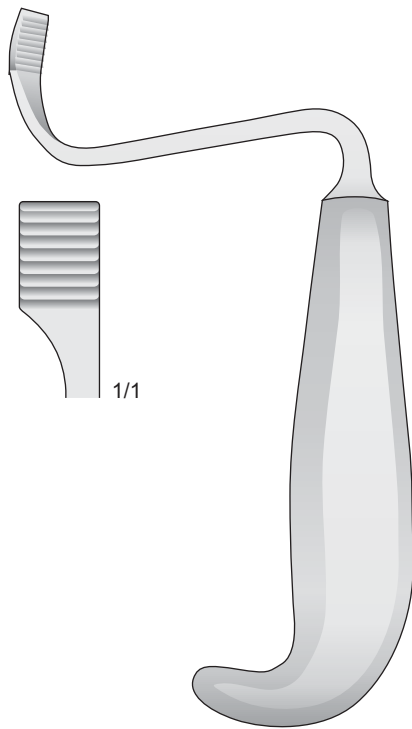
**DO-08**  
140 mm

**DO-09**  
150 mm

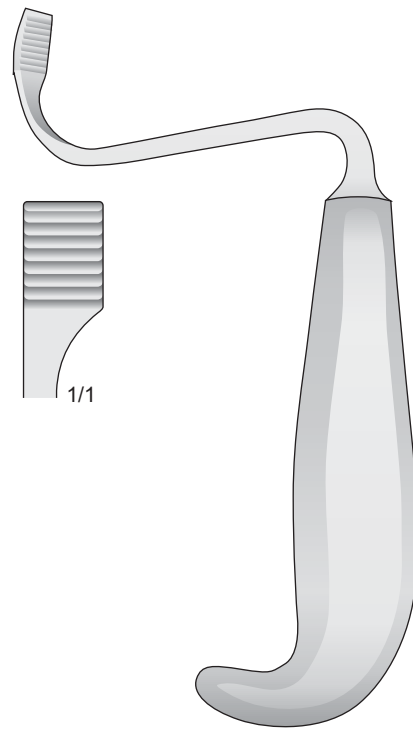
WIEDER  
**DO-08/DO-09**

TOBOLD  
**OM-08**  
145 mm

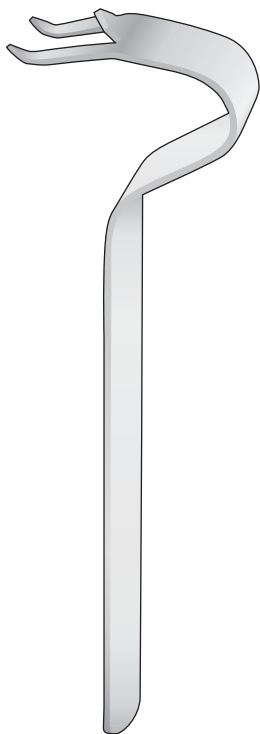
HARTMANN  
**OM-06**  
150 mm



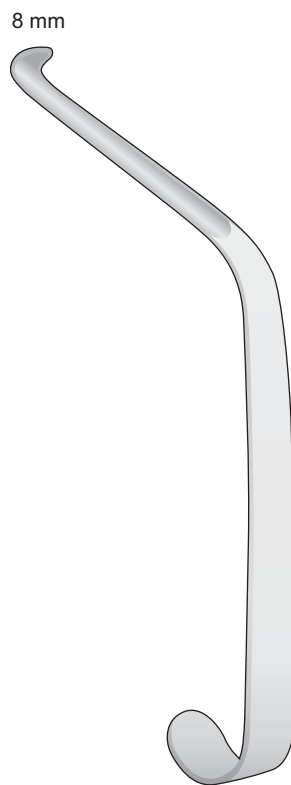
TESSIER  
DO-42  
150 mm



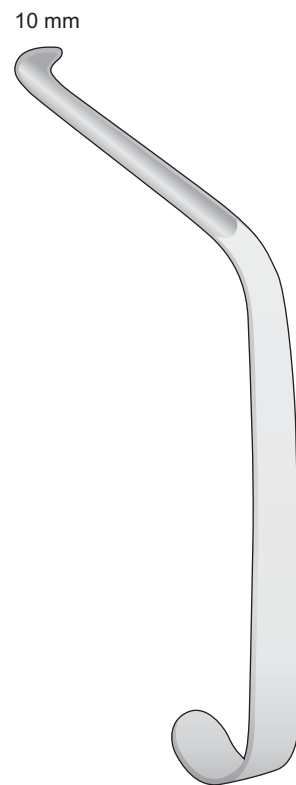
TESSIER  
DO-43  
150 mm



OBWEGESER  
DO-40  
155 mm



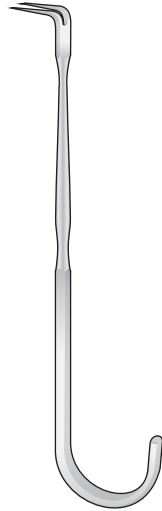
OBWEGESER  
DO-41  
165 mm



OBWEGESER  
DO-142  
165 mm

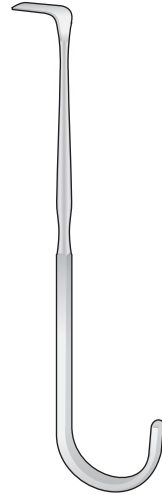


6 x 13 mm



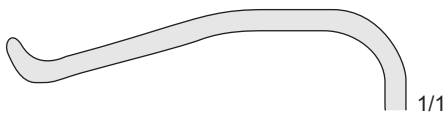
DUNN-DAUTREY  
**DO-198**  
130 mm

8 x 18 mm



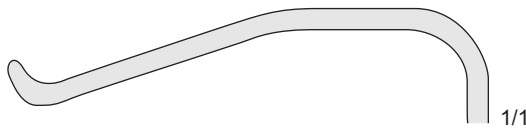
DUNN-DAUTREY  
**DO-199**  
125 mm

Posteriore  
Posterior



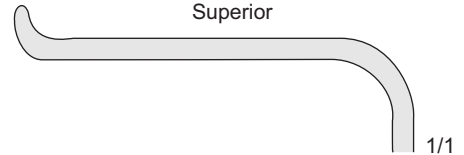
DUNN-DAUTREY  
**DO-94** 6,5 x 50 mm  
140 mm

Anteriore  
Anterior

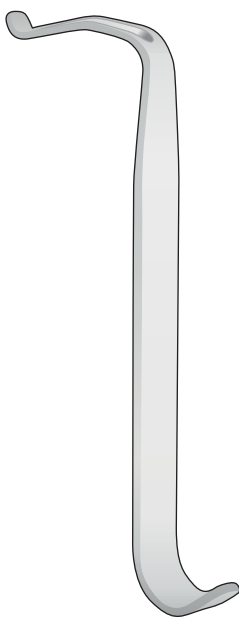


DUNN-DAUTREY  
**DO-95** 6,5 x 60 mm  
140 mm

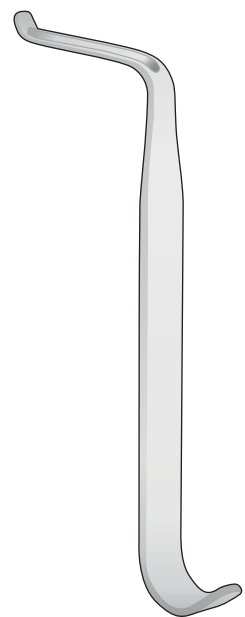
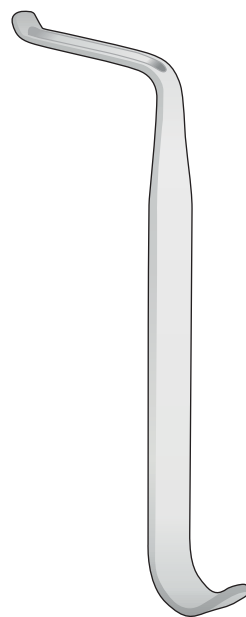
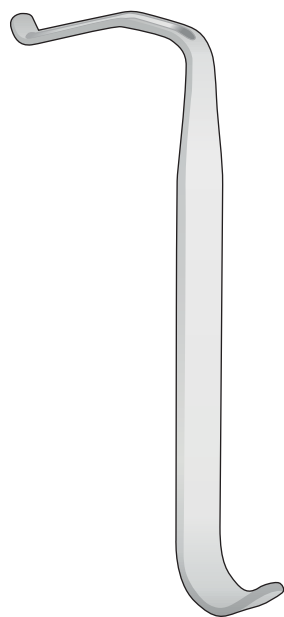
Superiore  
Superior

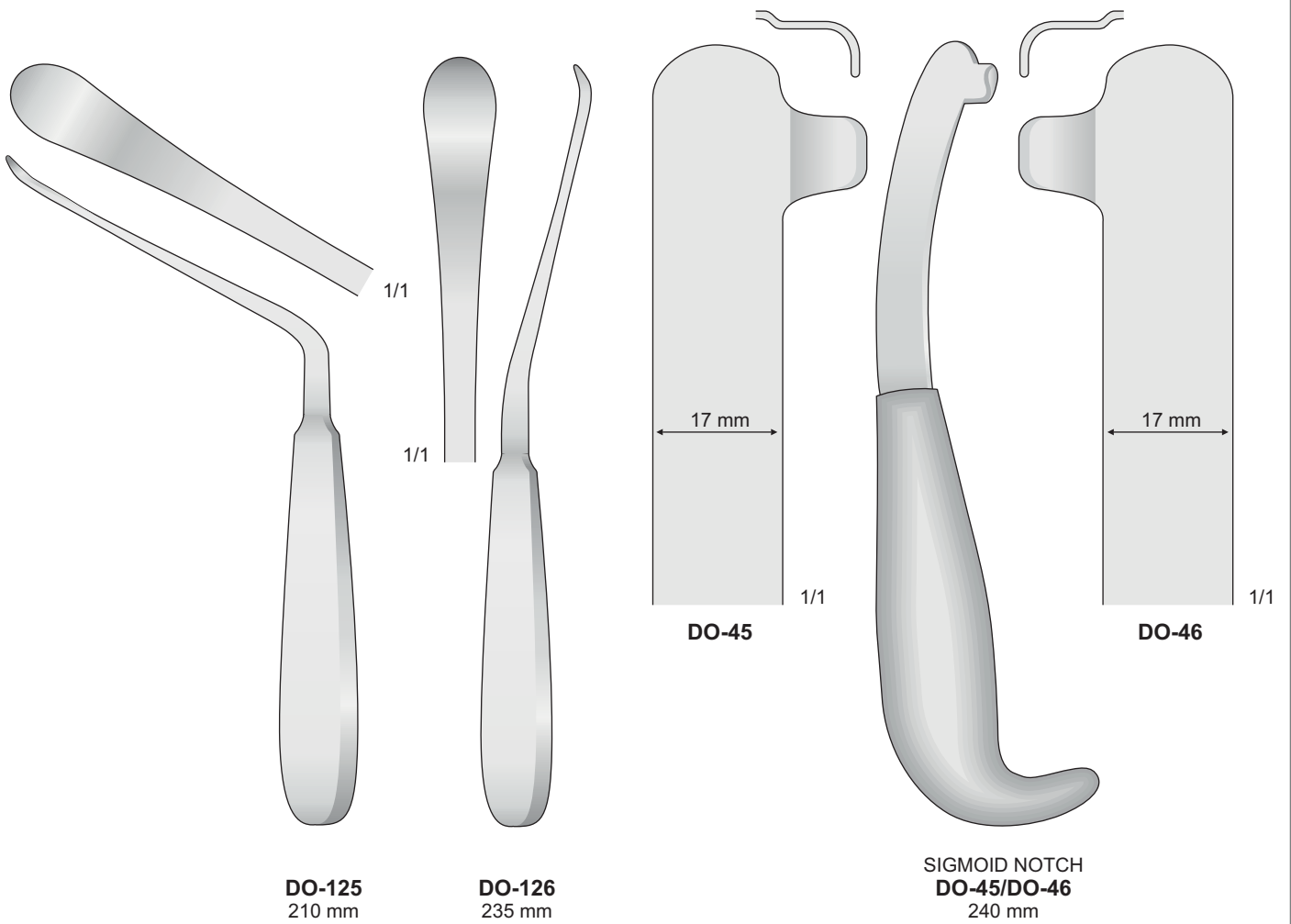


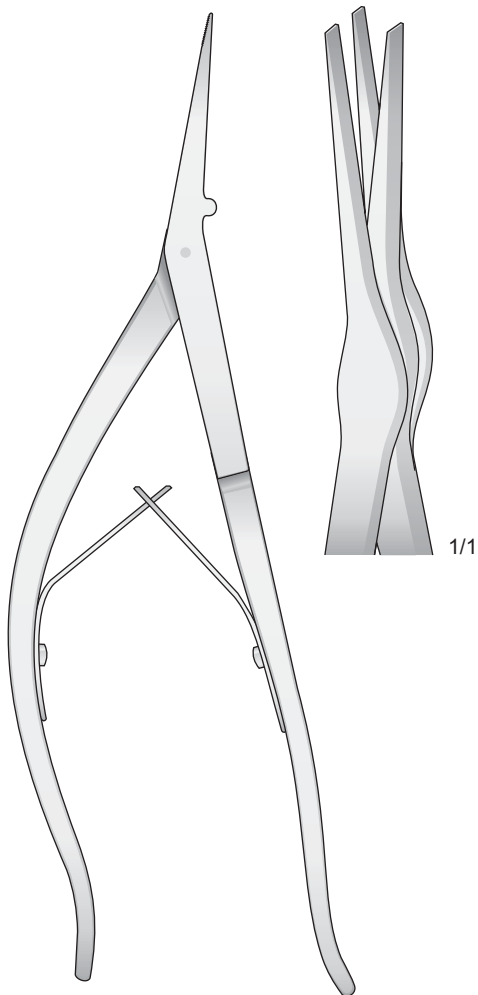
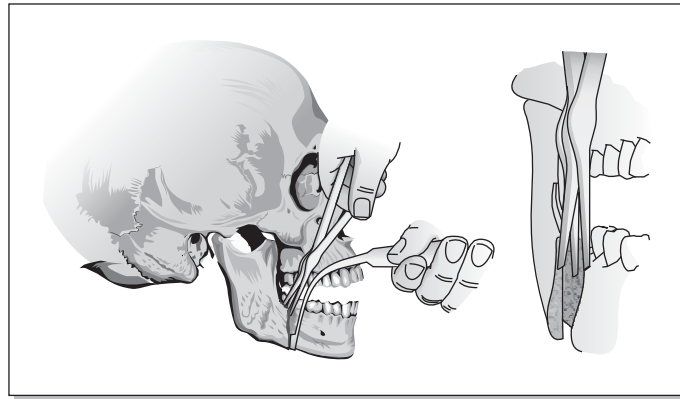
DUNN-DAUTREY  
**DO-96** 8 x 50 mm  
140 mm



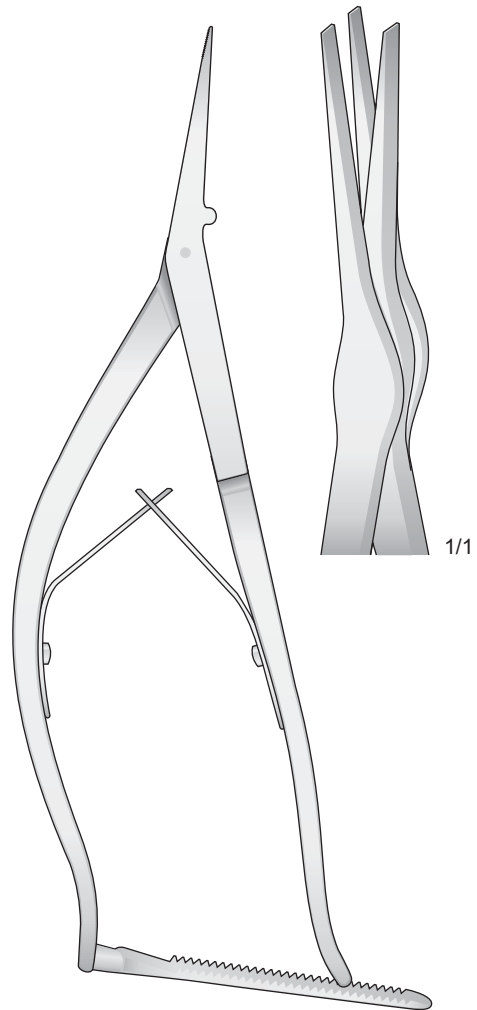
DUNN-DAUTREY  
**DO-97** 6,5 x 50 mm  
140 mm



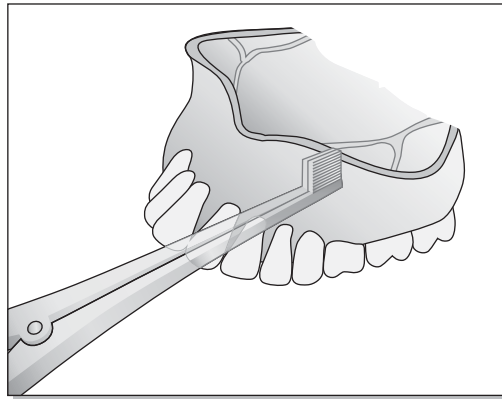




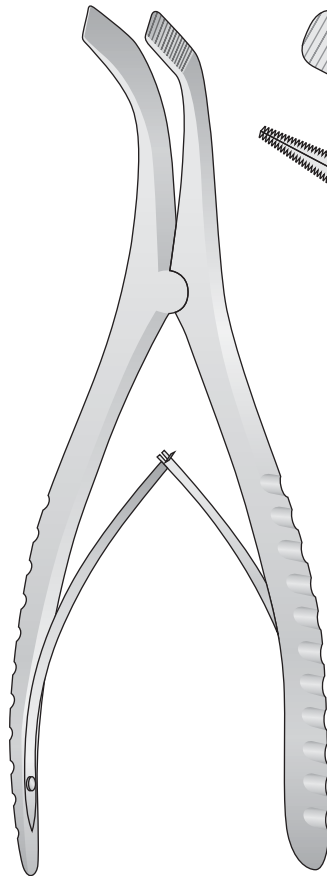
RAMUS  
DO-247  
230 mm



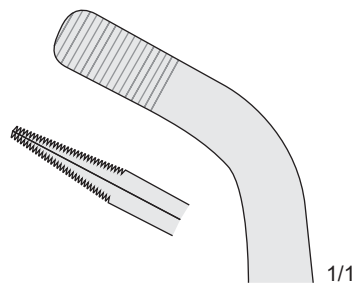
RAMUS  
DO-248  
230 mm



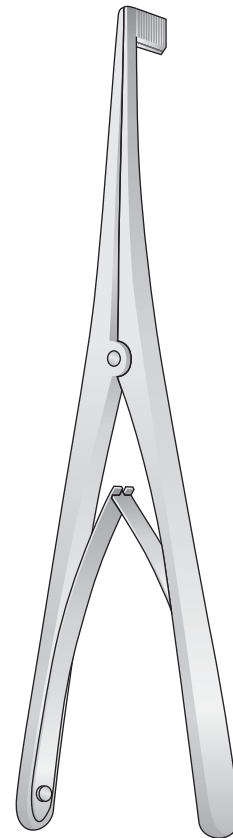
Bone spreaders



TESSIER  
DO-19  
180 mm



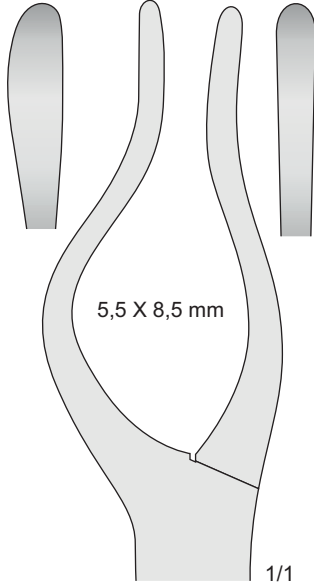
Maxillary palatal



DO-29  
170 mm

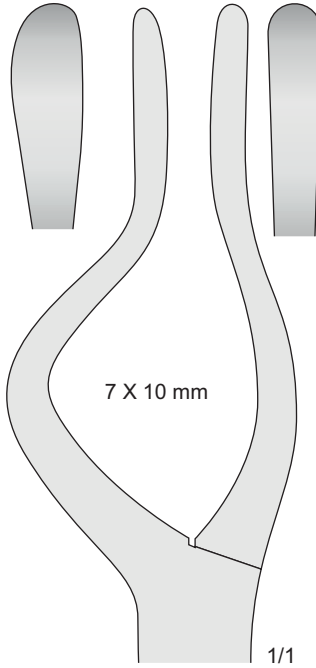


Lattanti  
For juveniles  
Für Jugendliche



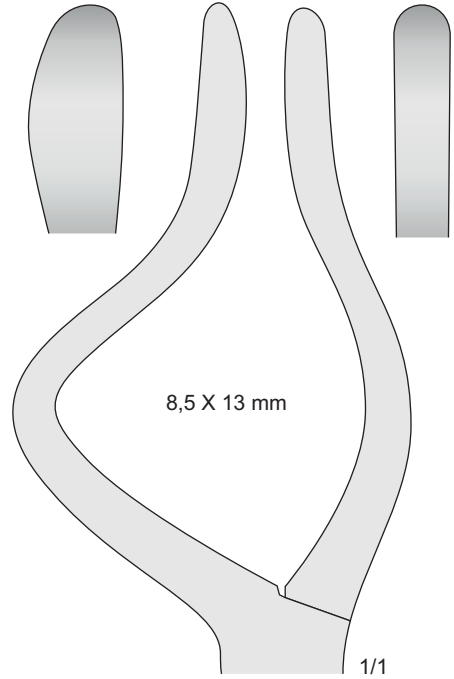
**DO-10**  
**DO-11**  
225 mm

Per bambini  
For children  
Für Kinder  
Pour enfants  
Para niños

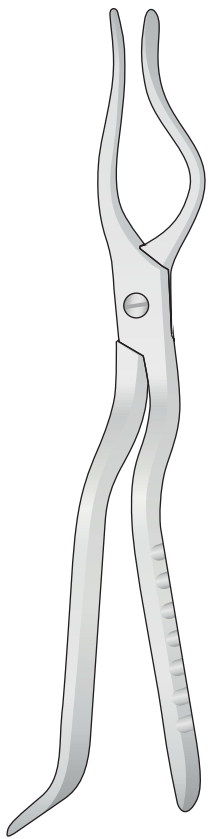


**DO-12**  
**DO-13**  
235 mm

Per adulti  
For adults  
Für Erwachsene  
Pour adultes  
Para adultos



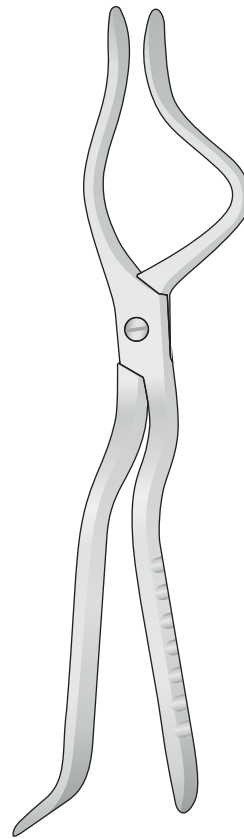
**DO-14**  
**DO-15**  
240 mm



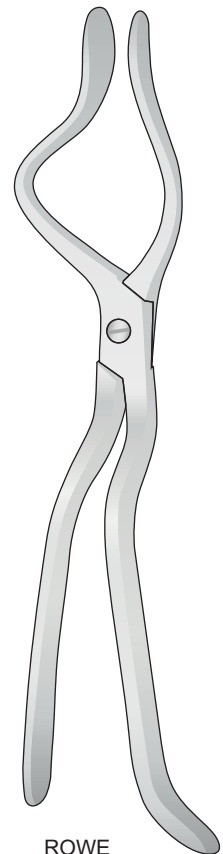
ROWE



ROWE



ROWE

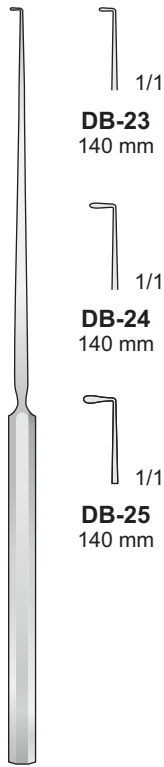


ROWE





Uncini - Ear hooks - Ohrhebel



LUCAE  
DB-23/DB-25  
140 mm



DB-23  
140 mm



DB-24  
140 mm



DB-25  
140 mm

Curette - Curettes - Löffel - Curettes - Curetas



SHAPLEIGH  
DB-36/DB-39  
130 mm



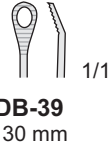
DB-36  
130 mm



DB-37  
130 mm



DB-38  
130 mm



DB-39  
130 mm

Uncini - Ear hooks - Ohrhebel



DAY  
DB-20/DB-21  
160 mm



DB-20

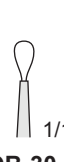


DB-21

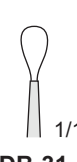
Anse auricolari - Ear loops anses - Ohrschlingen - Ansas auriculares



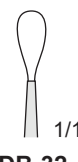
BILLEAU  
DB-30/DB-32  
160 mm



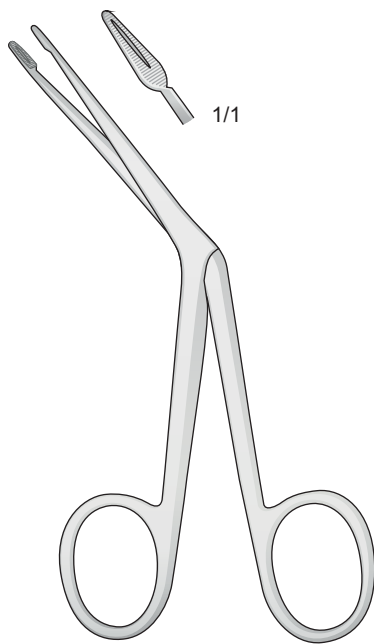
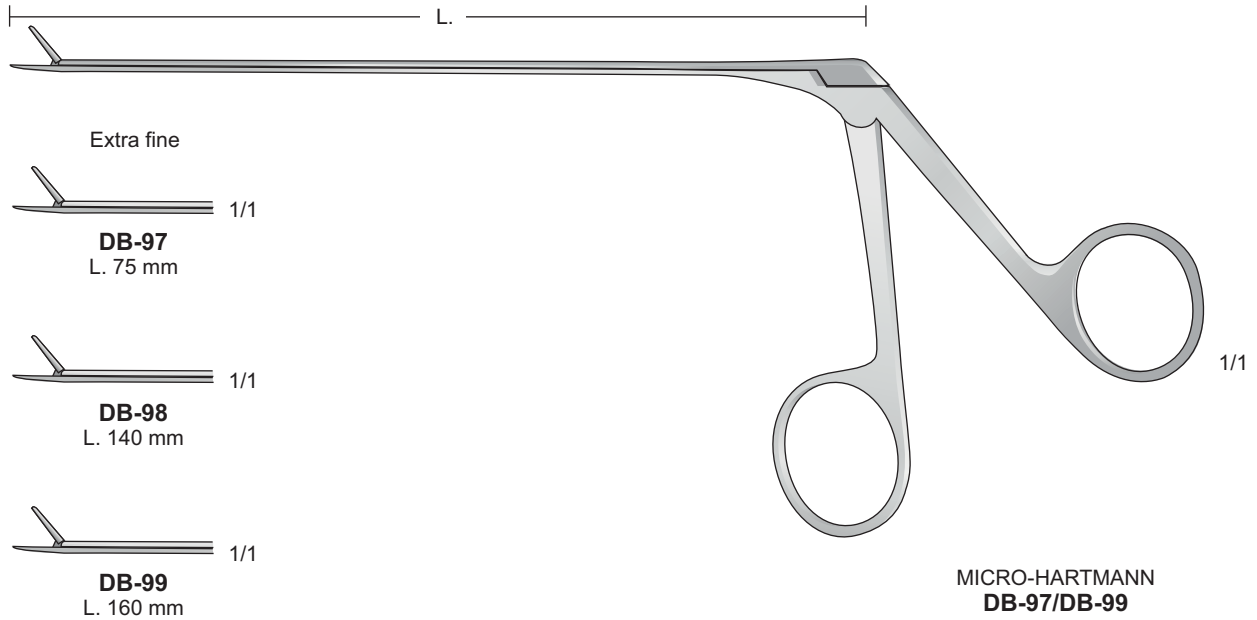
DB-30



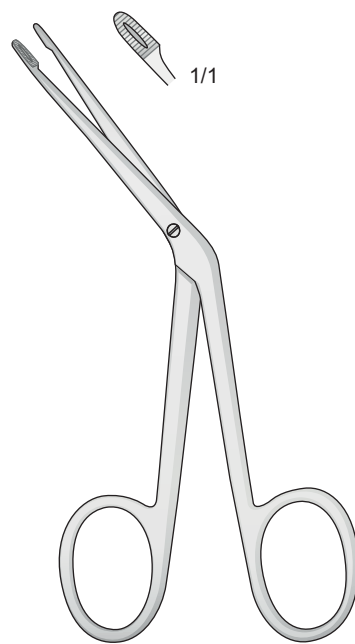
DB-31



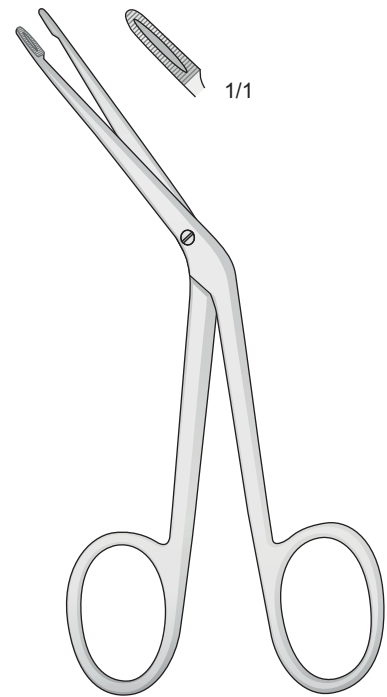
DB-32



LITTAUER  
**DB-111**  
120 mm



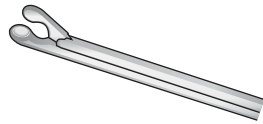
HARTMANN  
**DB-113**  
120 mm



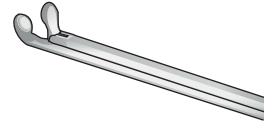
HARTMANN  
**DB-114**  
140 mm



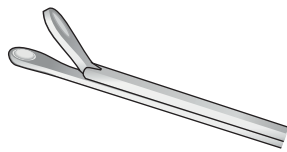
Pinze auricolari  
Ear Forceps  
Ohr-Polypenzangen  
Pinces pour polypes auriculaires  
Pinzas auricolàres



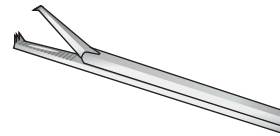
**DB-124**  
L.85 mm



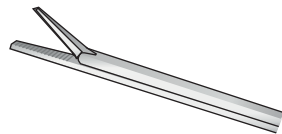
**DB-125**  
L.85 mm



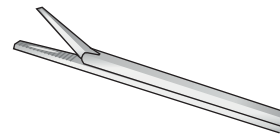
**DB-129**  
L.85 mm



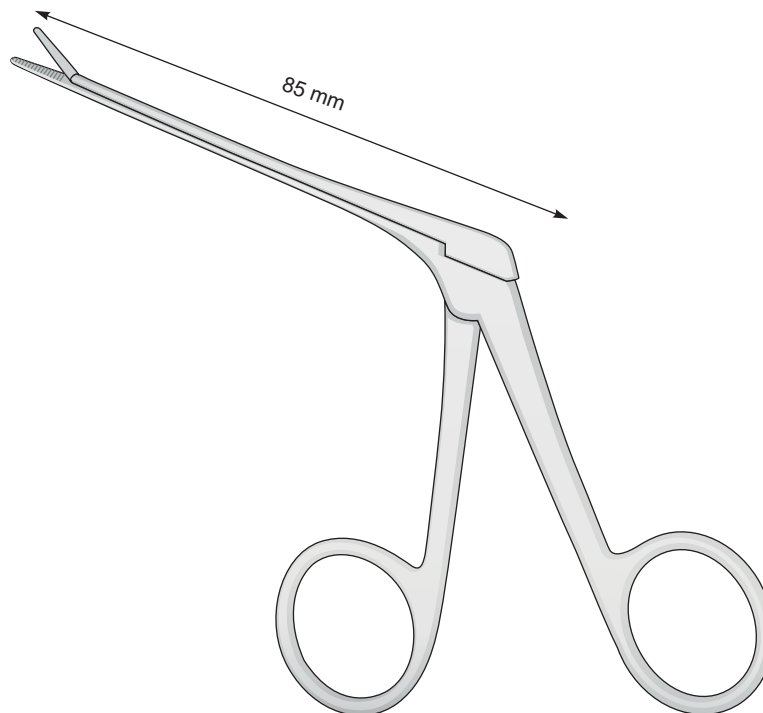
**DB-123**  
L.85 mm



**DB-120**  
L.85 mm



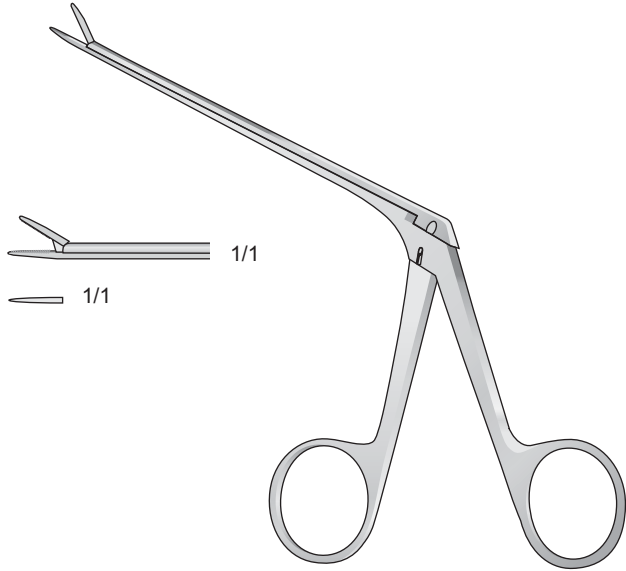
**DB-121**  
L.140 mm  
**DB-122**  
L.165 mm



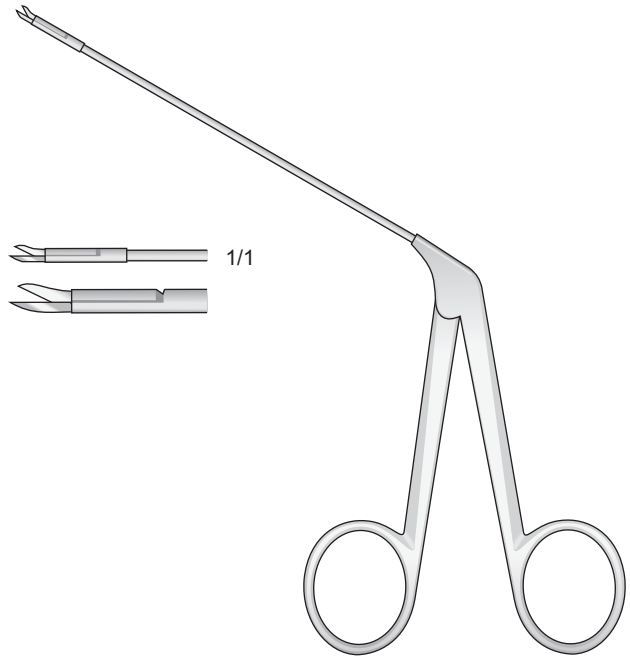
**DB-120/DB-129**  
L. 85 mm



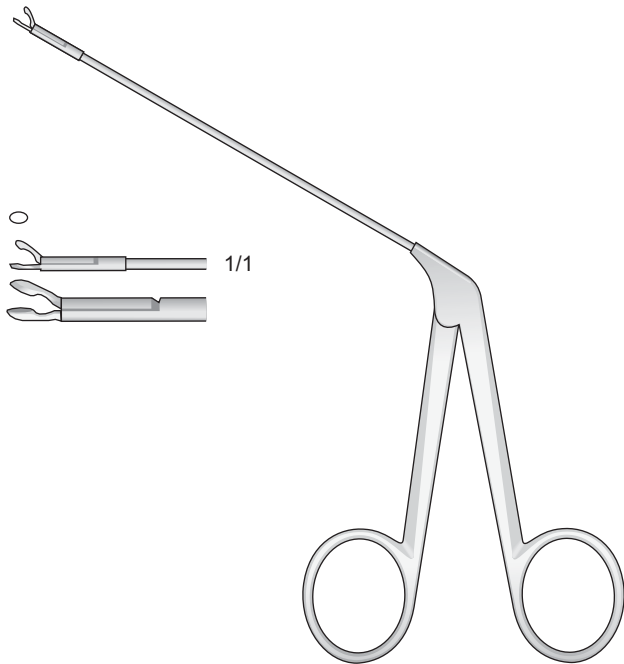
Micro forbice  
Micro scissor  
Mikro Scheren  
Micro ciseaux  
Micro tijeras



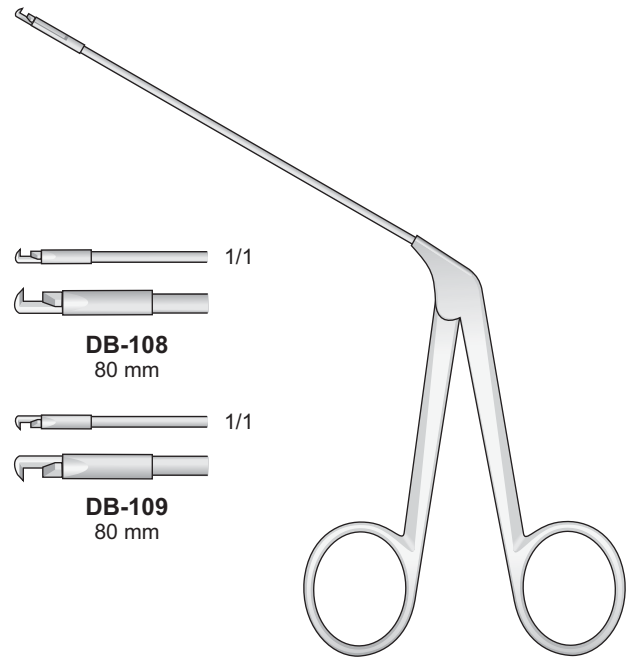
**DB-100**  
80 mm



**BELLUCCI**  
**DB-106**  
80 mm



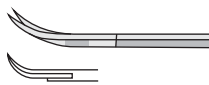
**WULLSTEIN**  
**DB-107**  
80 mm



**DIETER**  
**DB-108/DB-109**  
80 mm



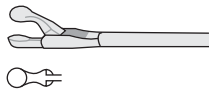
Mikro-Schere



FAHLBUSCH  
**FF-401**  
165 mm

FAHLBUSCH  
**FF-411**  
230 mm

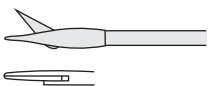
Scharfe Zange



NICOLA  
**FF-402**  
165 mm

NICOLA  
**FF-412**  
230 mm

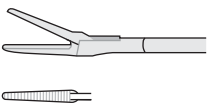
Mikro-Schere



NICOLA  
**FF-403**  
165 mm

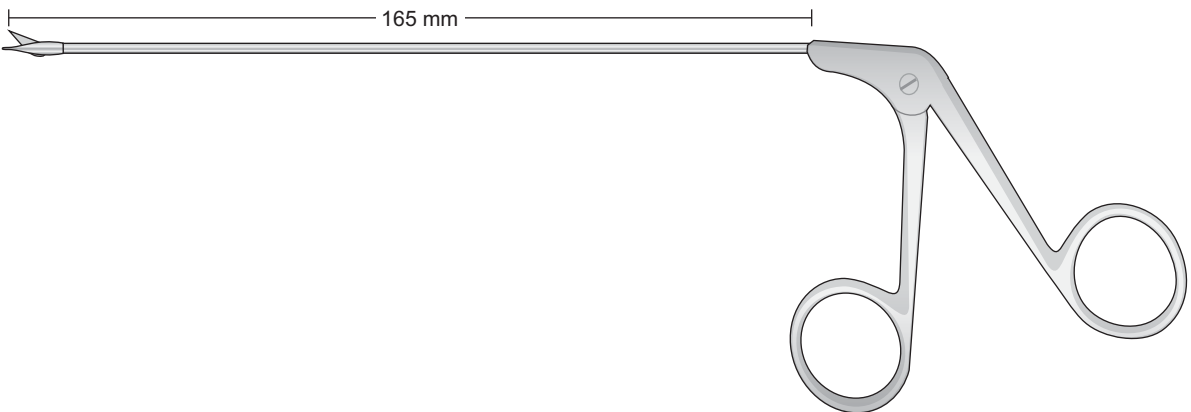
NICOLA  
**FF-413**  
230 mm

Faßzange

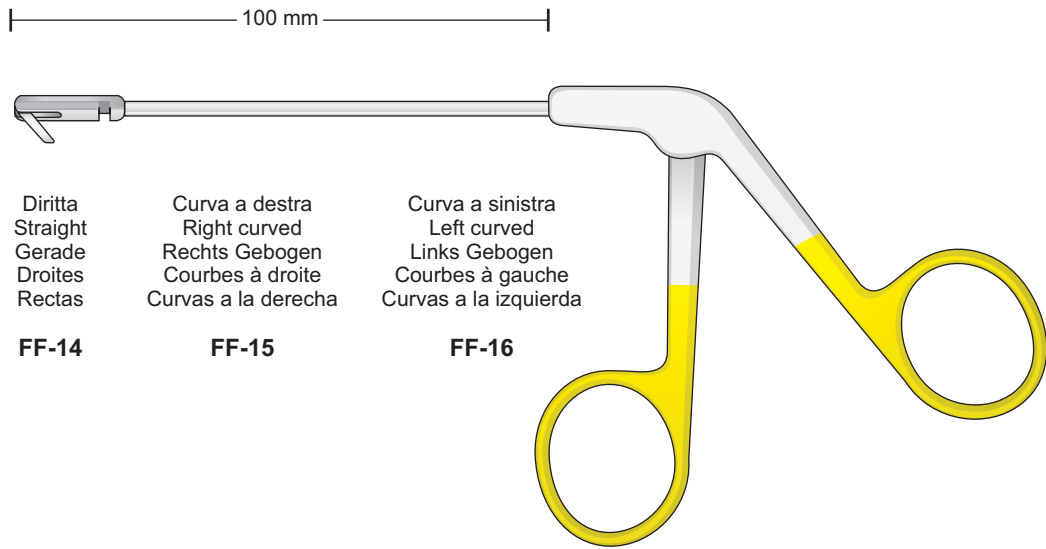


YASARGIL-NICOLA  
**FF-404**  
165 mm

YASARGIL-NICOLA  
**FF-414**  
230 mm



NICOLA  
**FF-403**  
165 mm



Diritta  
Straight  
Gerade  
Droites  
Rectas

**FF-14**

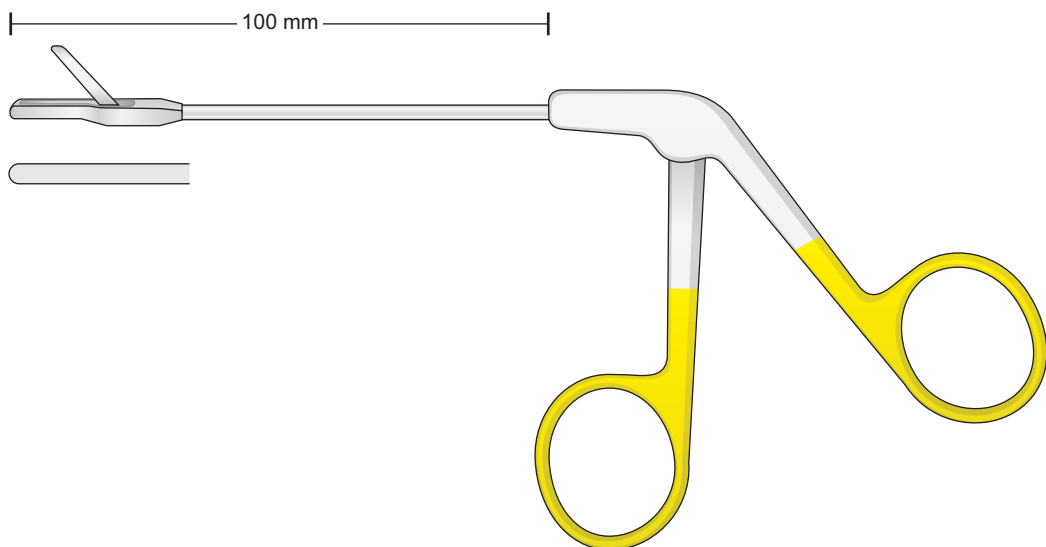
Curva a destra  
Right curved  
Rechts Gebogen  
Courbes à droite  
Curvas a la derecha

**FF-15**

Curva a sinistra  
Left curved  
Links Gebogen  
Courbes à gauche  
Curvas a la izquierda

**FF-16**

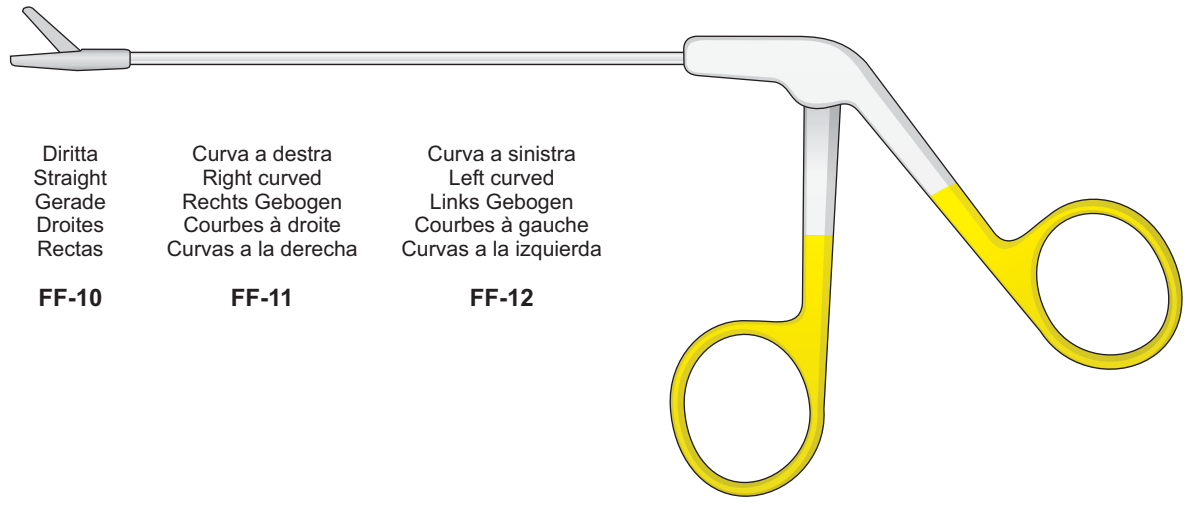
**STAMBERGER  
FF-14/FF-16**



**STRUYCKEN  
FF-17**



130 mm



Diritta  
Straight  
Gerade  
Droites  
Rectas

**FF-10**

Curva a destra  
Right curved  
Rechts Gebogen  
Courbes à droite  
Curvas a la derecha

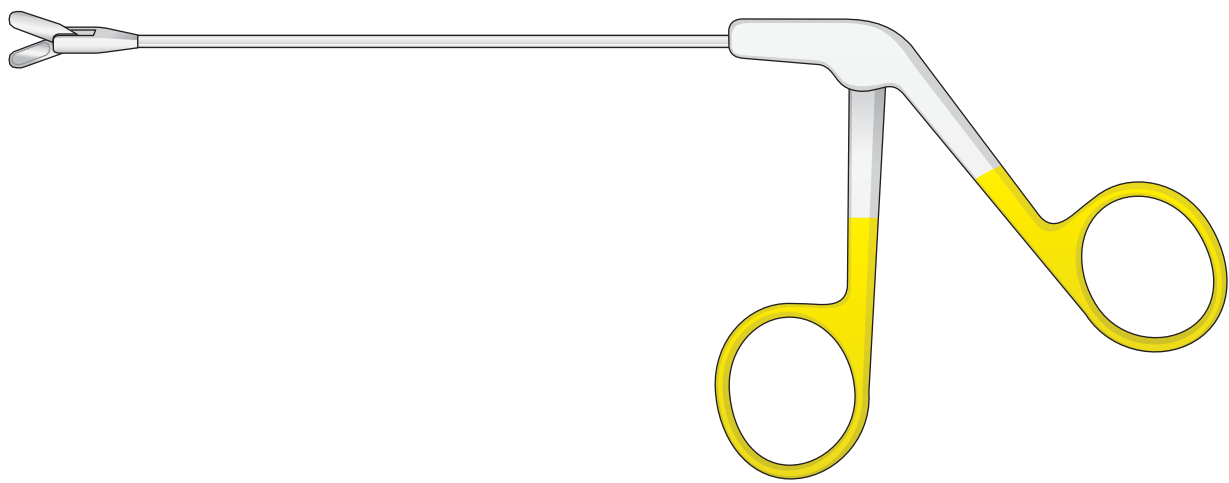
**FF-11**

Curva a sinistra  
Left curved  
Links Gebogen  
Courbes à gauche  
Curvas a la izquierda

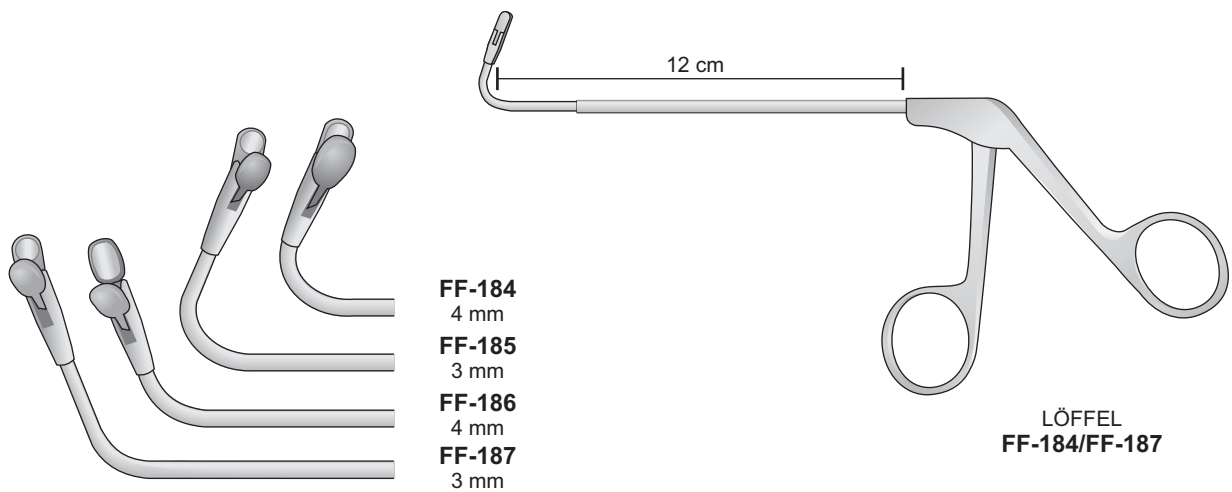
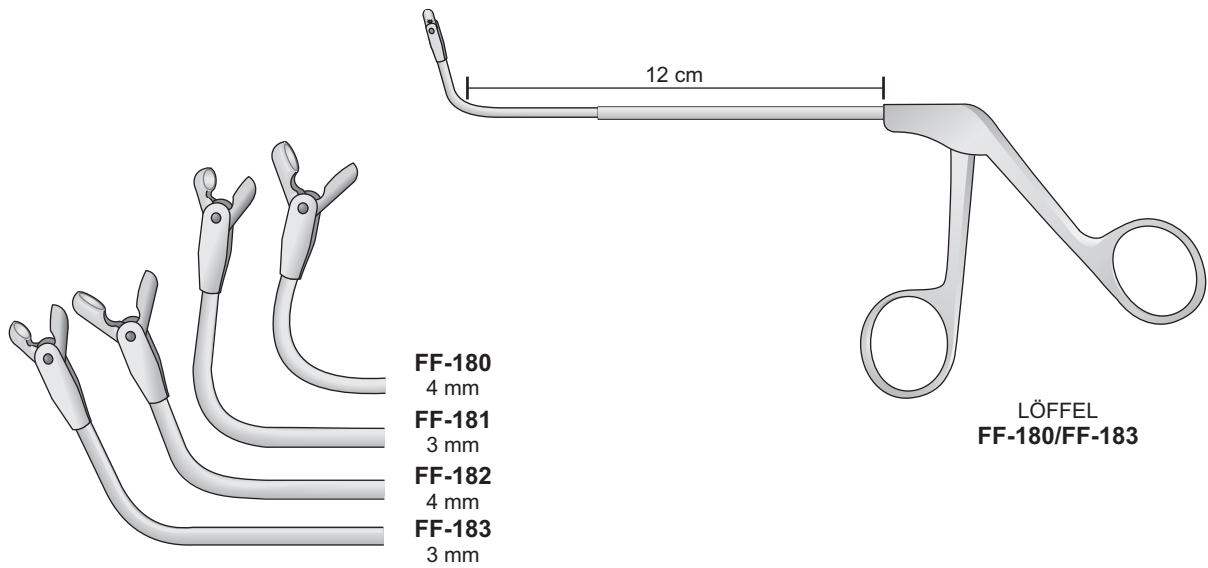
**FF-12**

**FF-10/FF-12**

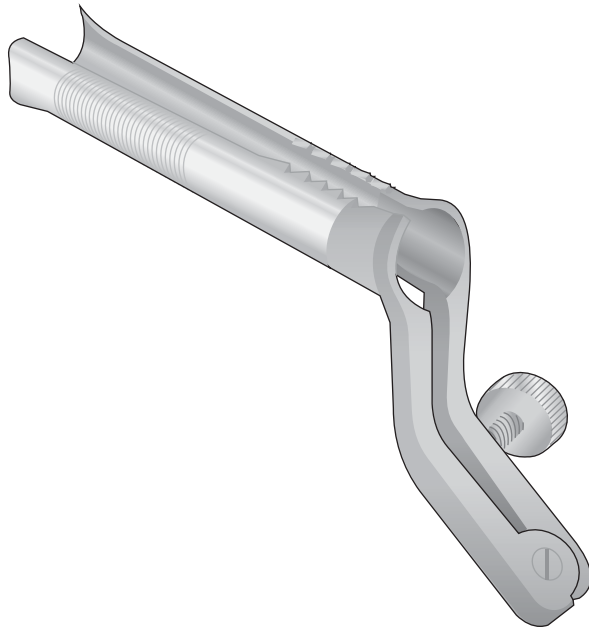
140 mm



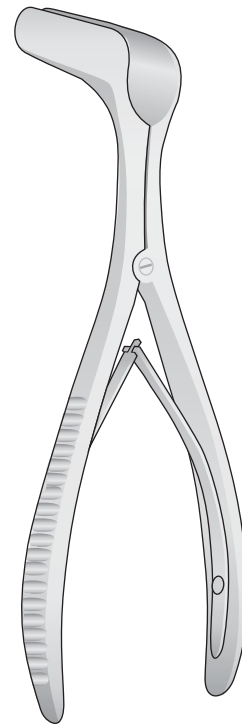
**FF-13**



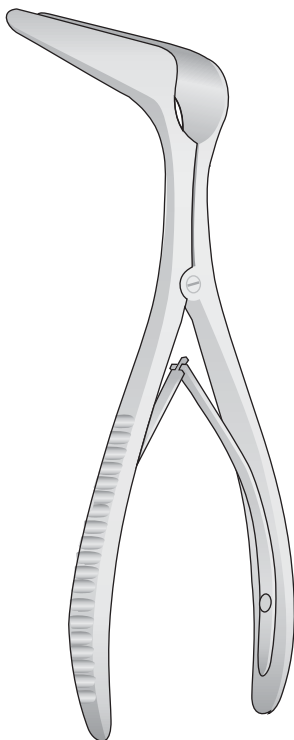




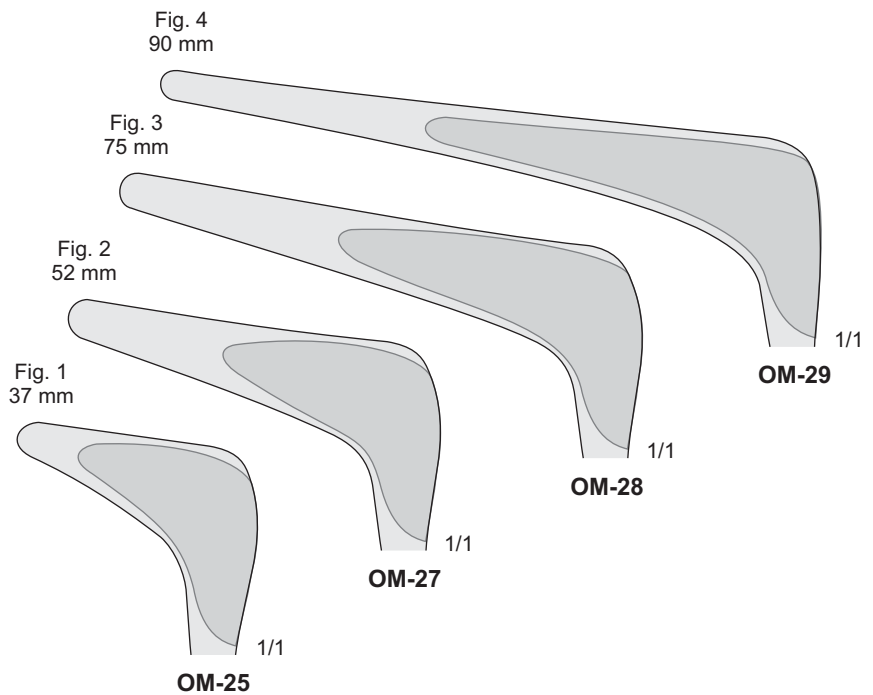
PAPAVERO-CASPAR  
**FF-214** 80 x 11 mm  
**FF-215** 90 x 13 mm  
**FF-216** 100 x 15 mm



PAPAVERO-HARTMANN  
**OM-39**  
 140 mm

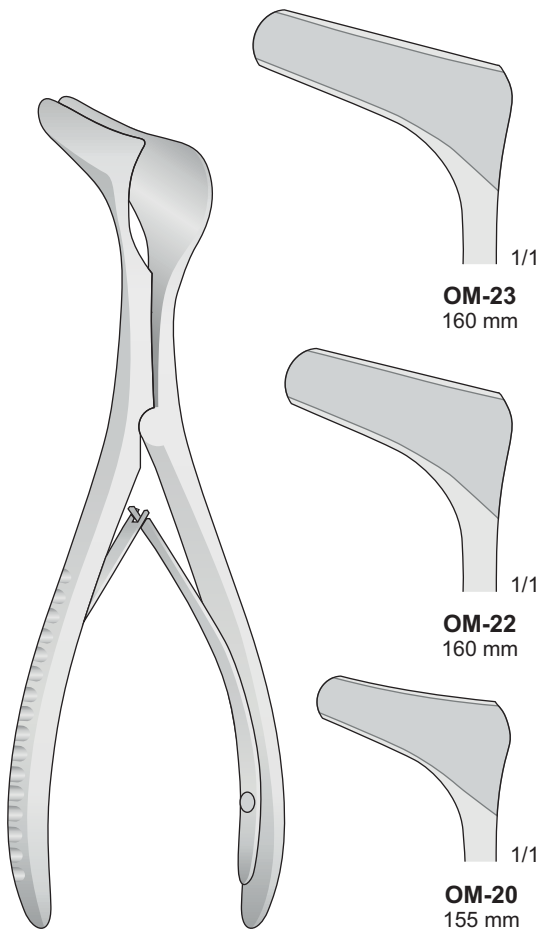


COTTLE  
**OM-25/OM-29**  
 150 mm

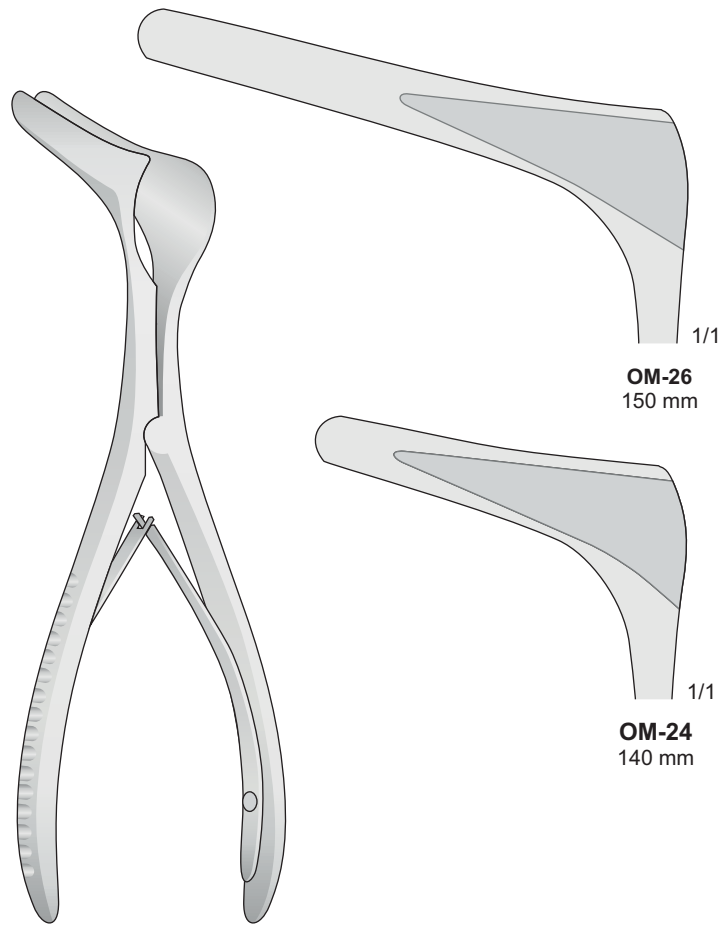




Speculum nasali  
Nasal specula  
Nasen Spekula  
Spéculums nasaux  
Espéculos nasales



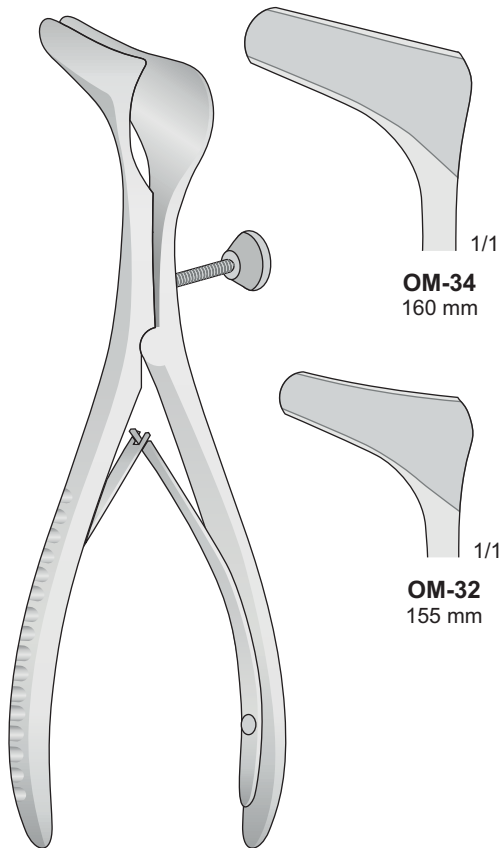
HARTMANN  
OM-20/OM-23



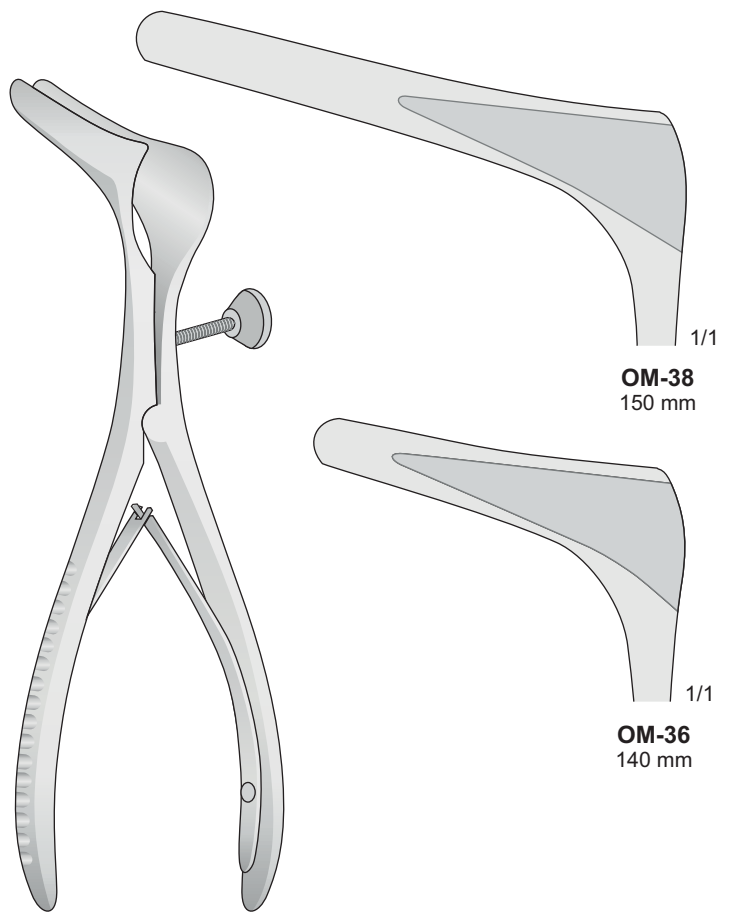
KILLIAN  
OM-24/OM-26



Speculum nasali  
Nasal specula  
Nasen Spekula  
Spéculums nasaux  
Espéculos nasales



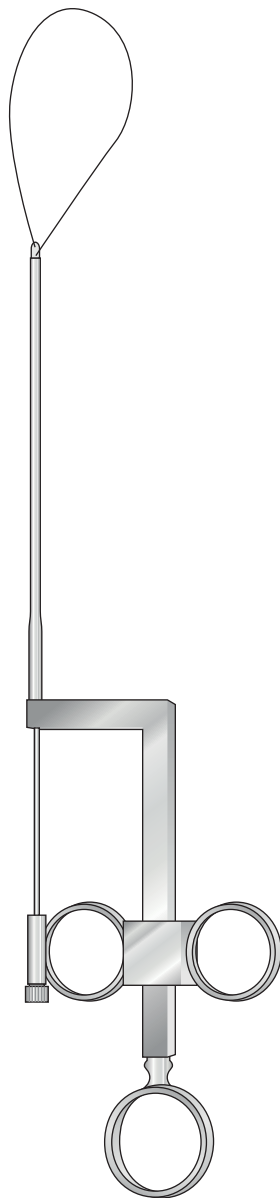
HARTMANN  
OM-32/OM-34



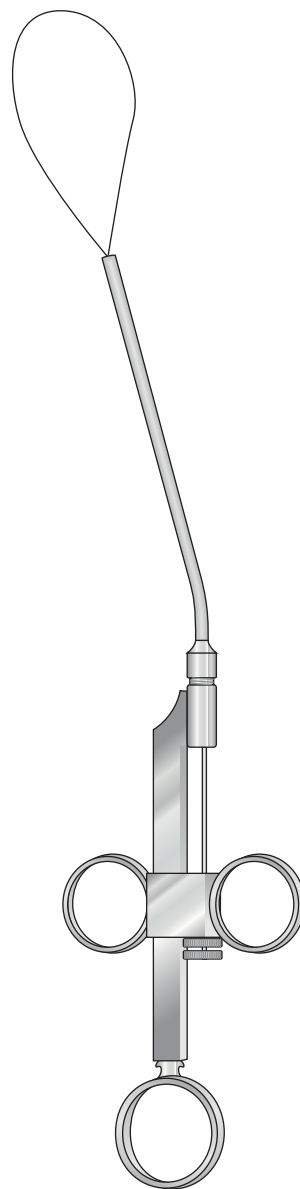
KILLIAN  
OM-36/OM-38



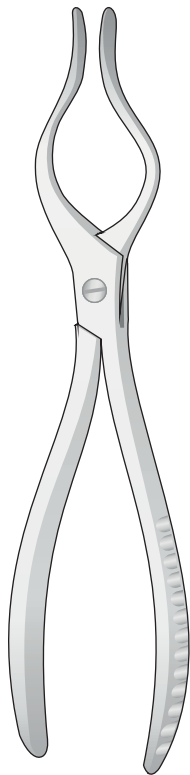
Pinza serranodi  
Ear polypus snares  
Polypenschnürer  
Serre noeuds  
Polipòtomos



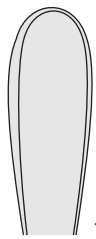
WILDE  
DO-16  
240 mm



KRAUSE  
DO-17  
260 mm

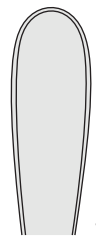


**COTTLE-WALSHAM**  
**DO-147/DO-149**  
230 mm



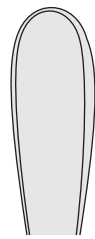
**DO-147**

1/1



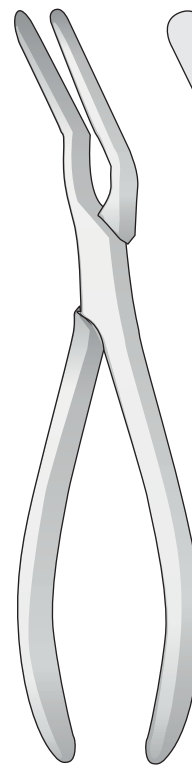
**DO-148**

1/1

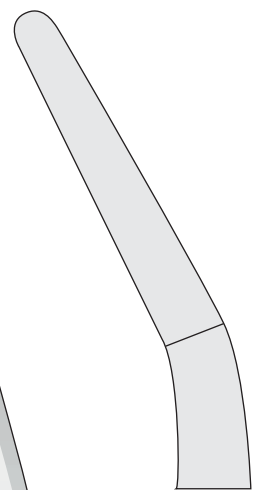


**DO-149**

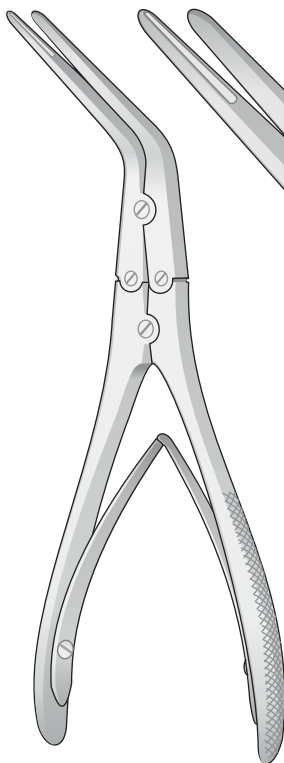
1/1



**ASH**  
**DO-157**  
230 mm



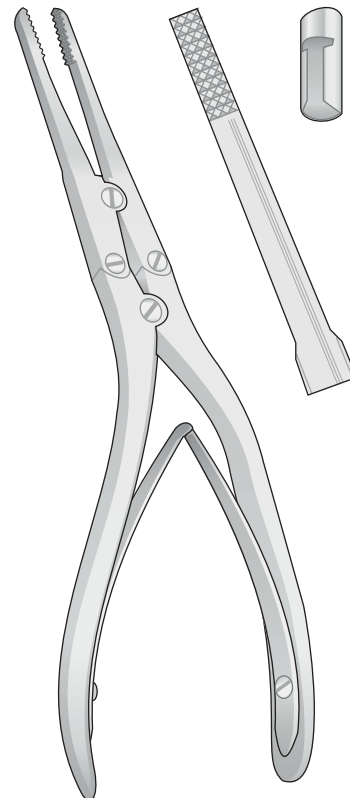
1/1



**KRESSNER**  
**FO-141**  
200 mm



1/1



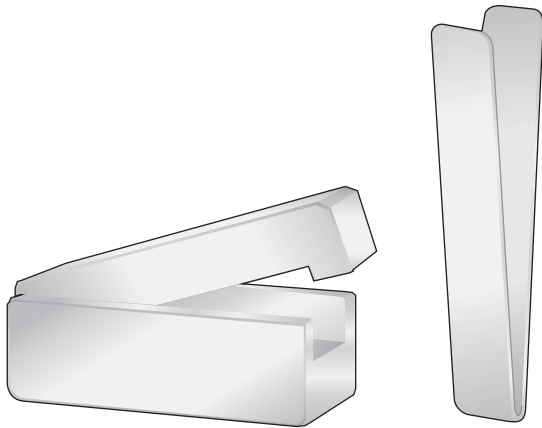
**RUBIN**  
**FO-142**  
210 mm



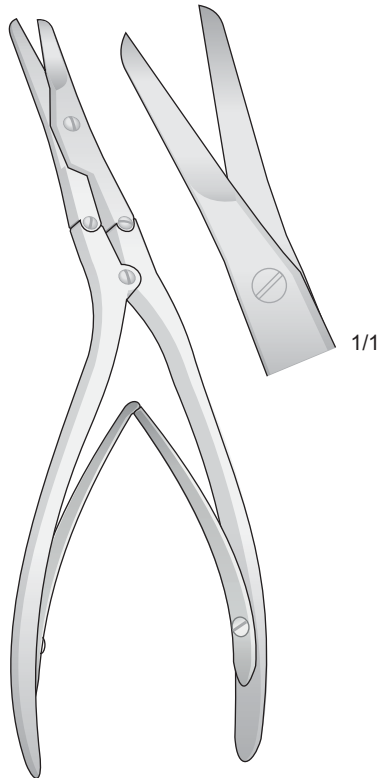
1/1



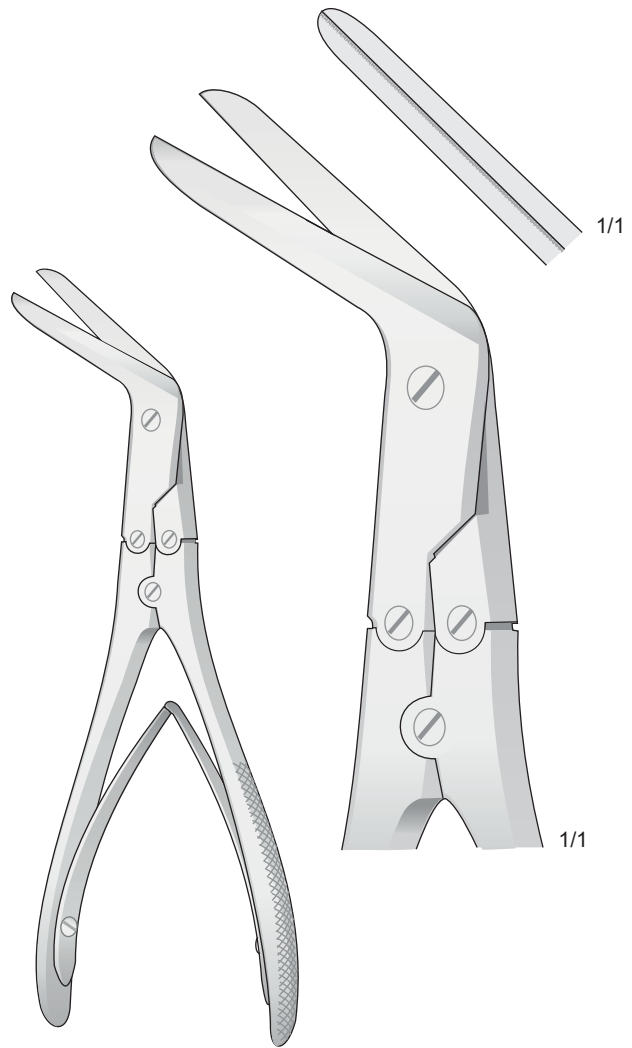
Strumento per rotture e asportazione frammenti ossei e cartilagine  
Bone crusher  
Knochen-Knorpelquetsche  
Instrument à écraser le cartilage  
Instrumento para magullar carilagos



**COTTLE  
DO-264**



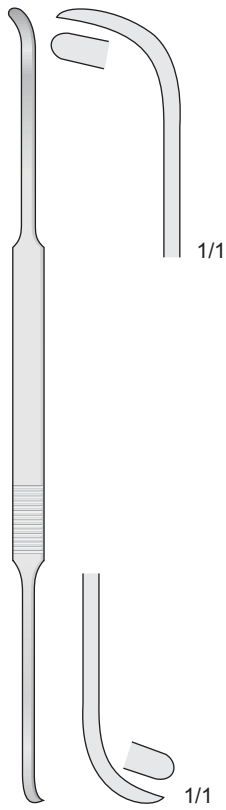
**CAPLAN  
FO-144  
200 mm**



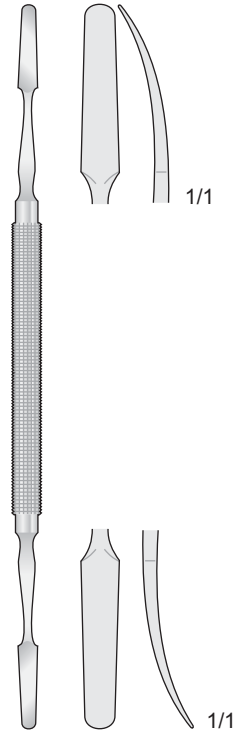
**KILLIAN  
FO-143  
210 mm**



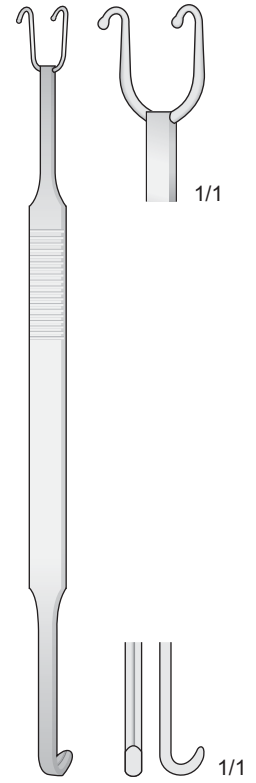
Tagliente/Smusso - Sharp/Blunt  
Scharf/Stumpf - Tranchant/Mousse  
Cortante/Romo



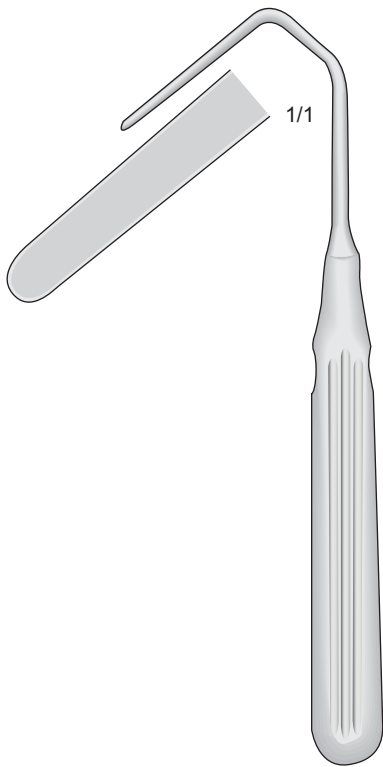
**COTTLE  
KO-12**  
230 mm



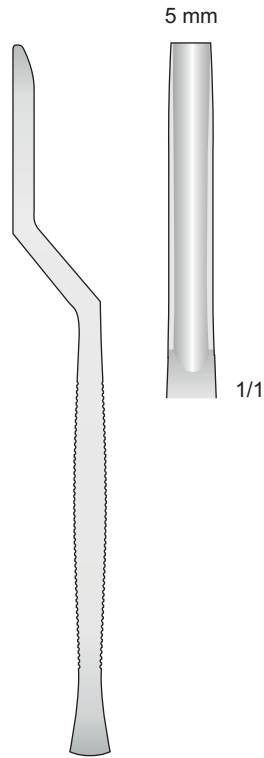
**KILIAN  
KO-11**  
180 mm



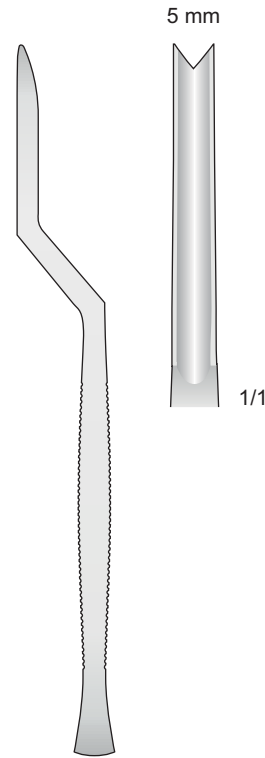
**COTTLE-NEIVERT  
BT-57**  
200 mm



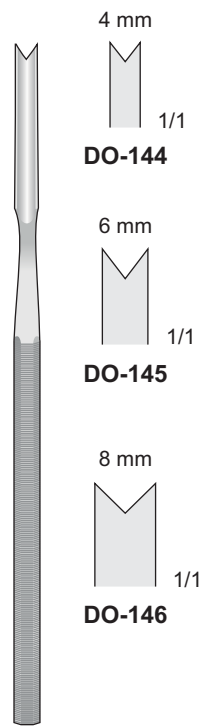
**AUFRICHT  
DO-48**  
175 mm



**KILIAN  
DO-91**  
160 mm



**KILIAN-KLAUS  
DO-92**  
160 mm



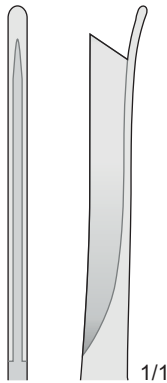
**BALLENGER  
DO-144/DO-146**  
150 mm



Diritta  
Straight  
Gerade  
Droites  
Rectas



SILVER  
**DO-34**  
180 mm

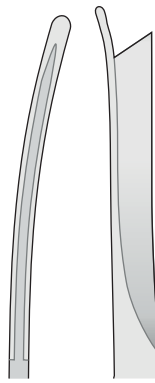


1/1

Curva, sinistra  
Curved, left  
Gebogen, links  
Courbes à gauche  
Curvas a la izquierda



SILVER  
**DO-35**  
180 mm

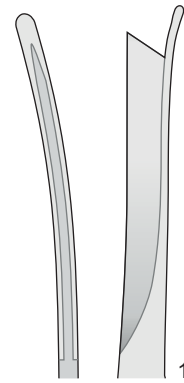


1/1

Curva, destra  
Curved, right  
Gebogen, rechts  
Courbes à droite  
Curvas a la derecha

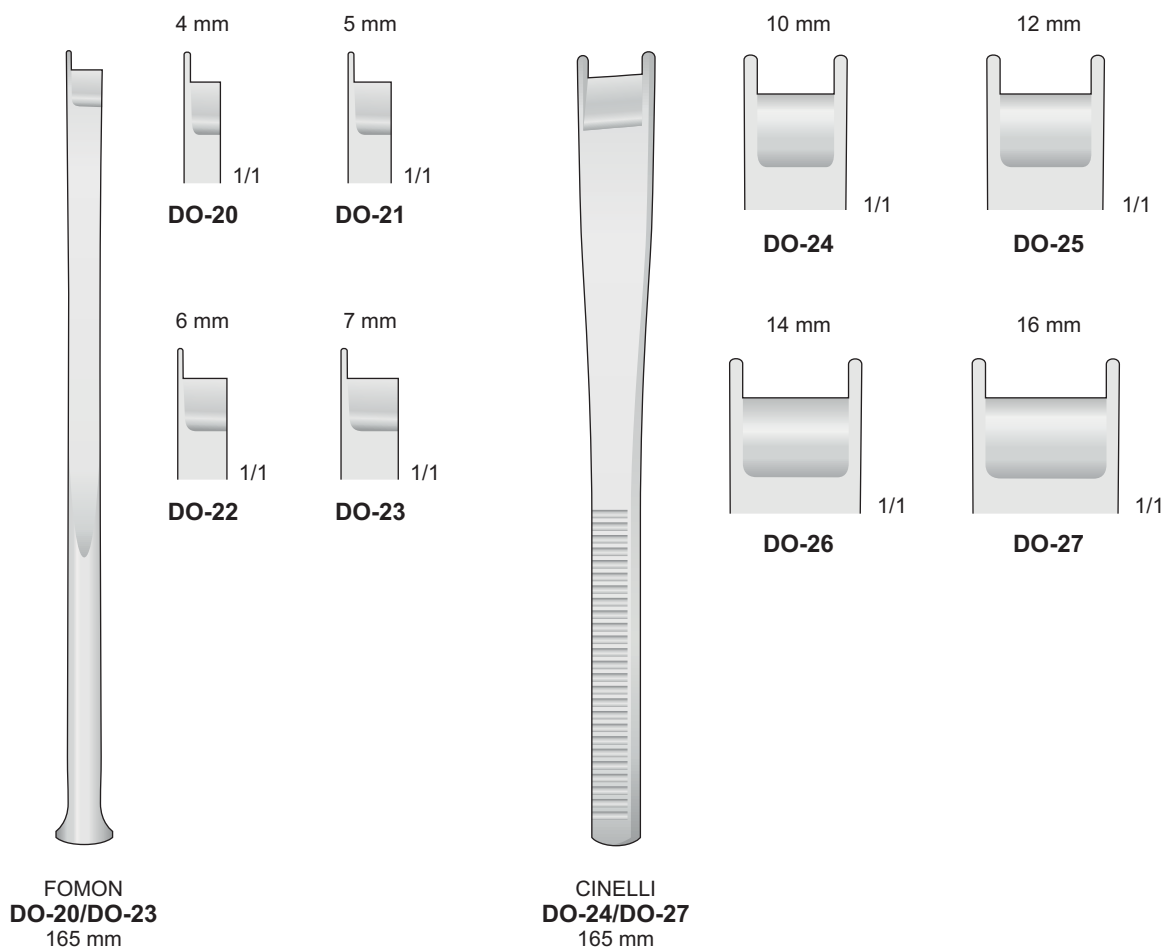


SILVER  
**DO-36**  
180 mm



1/1







Nasal septum  
Osteotomes, graduated

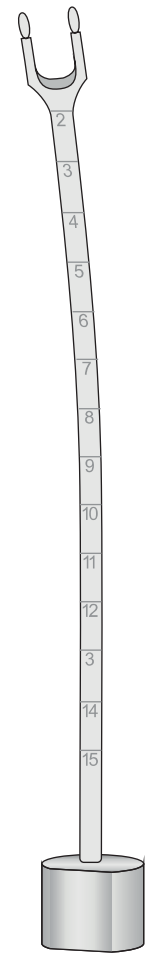
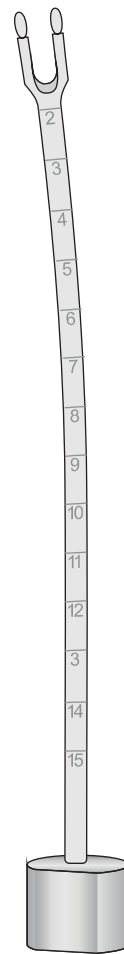
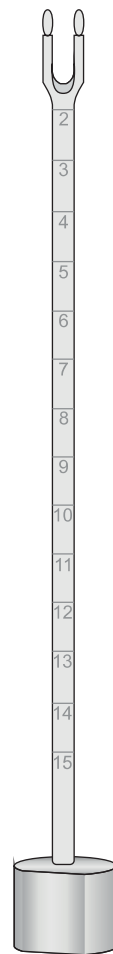
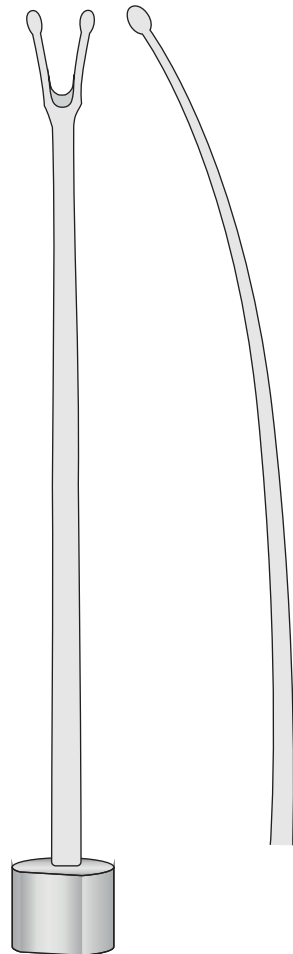
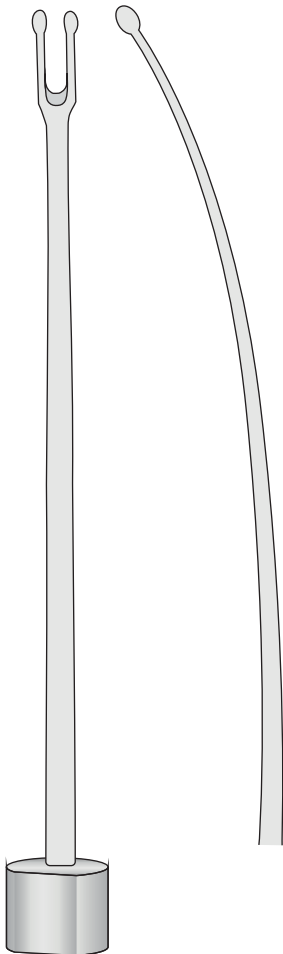
U form

V form

4 mm

6 mm

8 mm



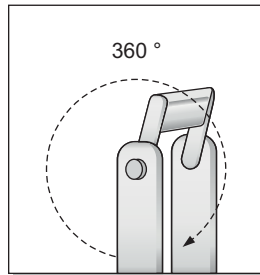
OBWEGESER  
**DO-110**  
185 mm

OBWEGESER  
**DO-112**  
185mm

OBWEGESER  
**DO-120**  
185 mm

OBWEGESER  
**DO-121**  
185 mm

OBWEGESER  
**DO-122**  
185 mm



**BALLENGER  
DO-50/DO-52**  
200 mm



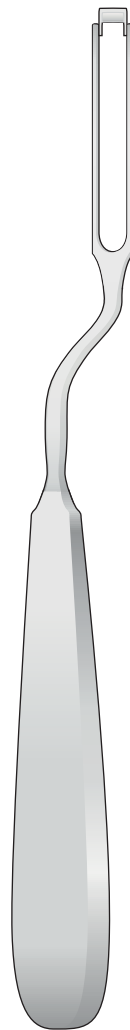
**DO-50**  
3 mm



**DO-51**  
4 mm



**DO-52**  
5 mm



**BALLENGER  
DO-53/DO-55**  
200 mm



**DO-53**  
3 mm



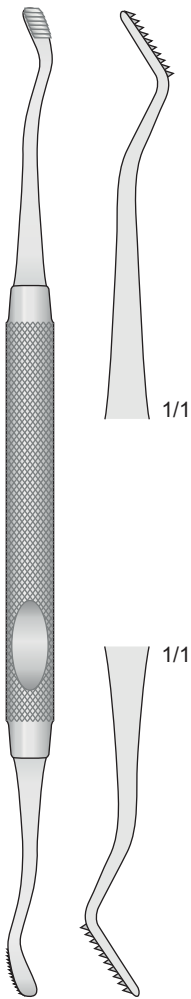
**DO-54**  
4 mm



**DO-55**  
5 mm

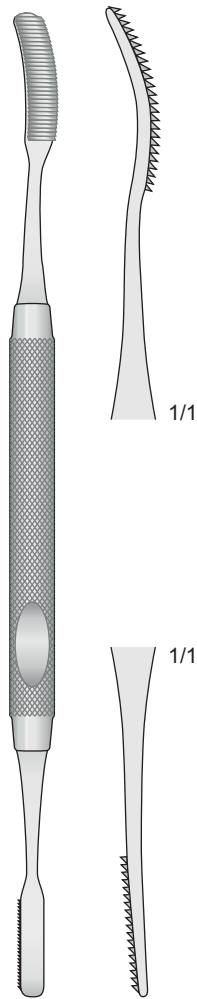


Fig. 67



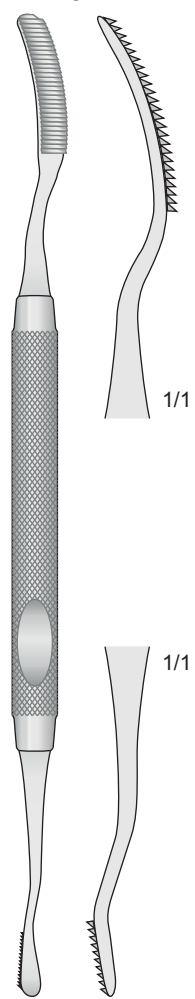
HOWARD  
DO-1  
180 mm

Fig. 45



MILLER  
DO-2  
185 mm

Fig. 52



MILLER  
DO-3  
180 mm



Lime nasali  
Nasal Files  
Nasenfeilen  
Limes nasales  
Limas nasales

Raspe nasali  
Nasal Rasp  
Nasenraspel  
Râpe nasales  
Raspador nasal

8 mm



8 mm  
**FK-96**  
210 mm

2 mm



5 mm  
**FK-97**  
210 mm



1/1



1/1

8 mm



8 mm  
**FK-98**  
210 mm

8 mm



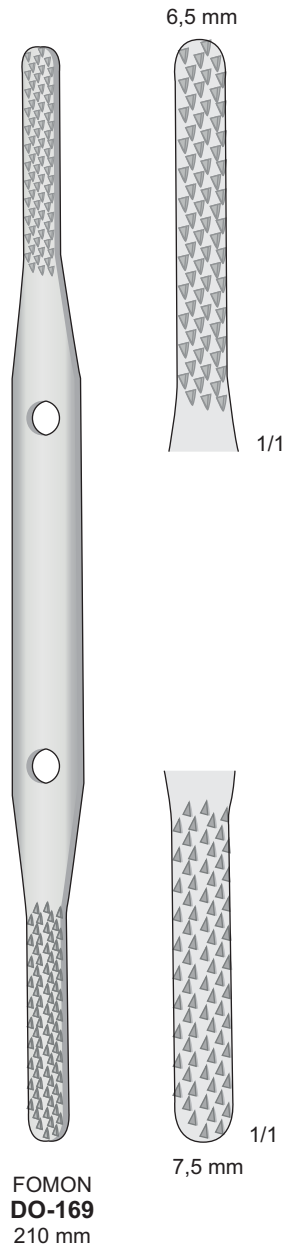
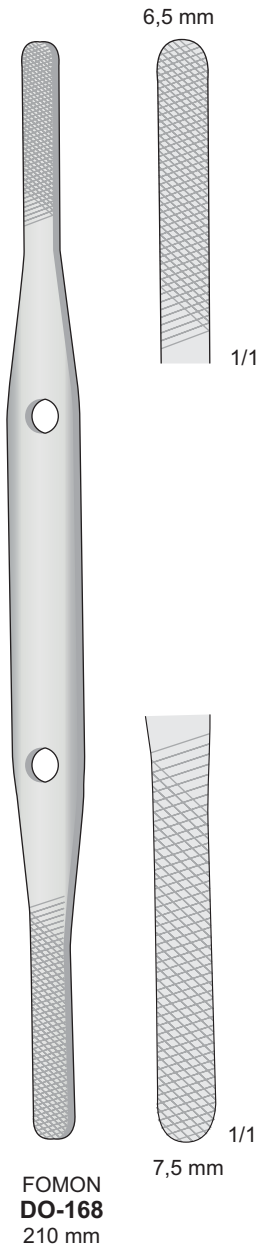
8 mm  
**FK-99**  
210 mm

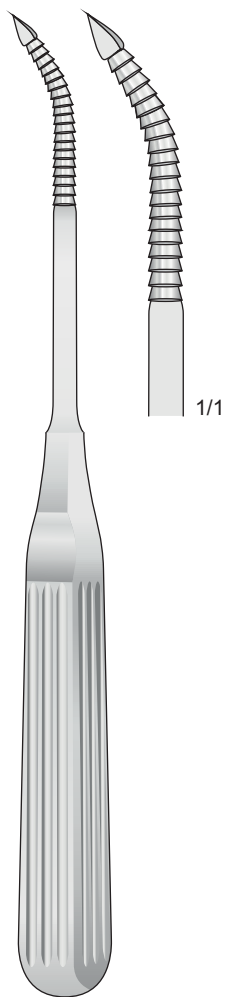


Lima nasale  
Nasal File  
Nasenfeilen  
Lime nasales  
Lima nasales

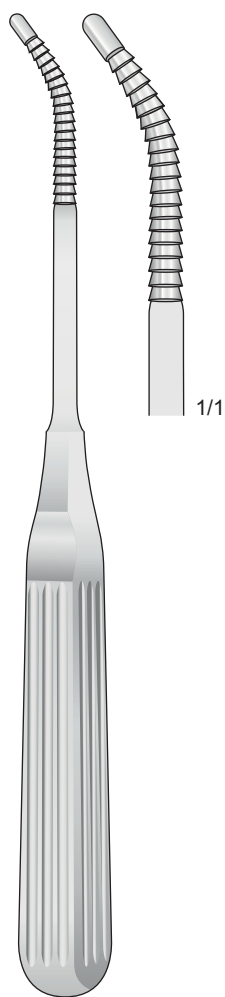
Raspa nasale  
Nasal Rasp  
Nasenraspel  
Râpe nasale  
Raspador nasal

Bisturi per mucosa  
Mucous knife  
Mukosamesser  
Septotome  
Cuchillo para mucosa





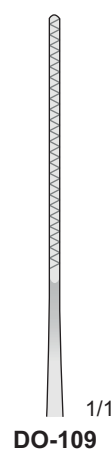
LEWIS  
DO-77  
180 mm



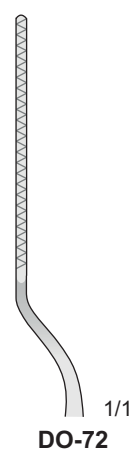
LEWIS  
DO-78  
180 mm



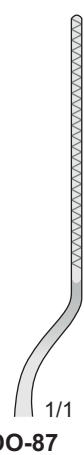
JOSEPH  
DO-72/DO-109  
190 mm



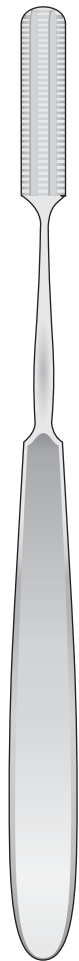
DO-109



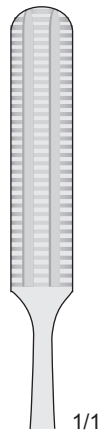
DO-72



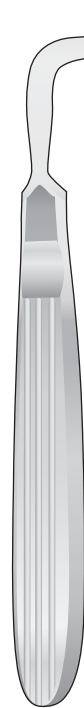
DO-87



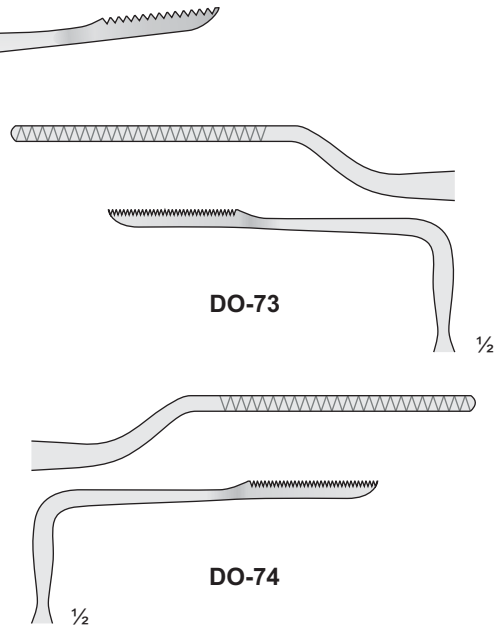
MALTZ  
DO-179  
180 mm



1/1



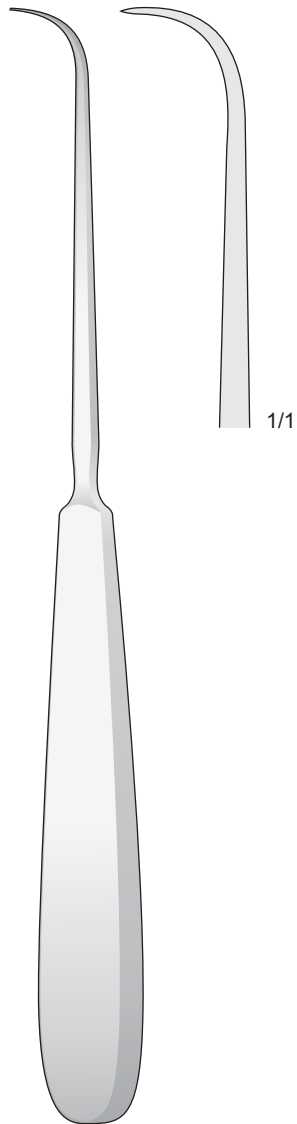
JOSEPH  
DO-73/DO-74  
135 mm





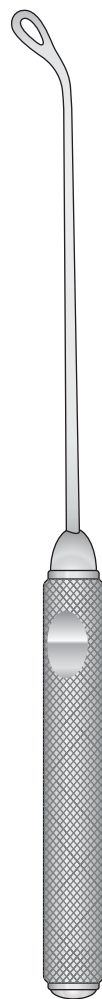


Uncino per arco zigomato  
Zigoma hook  
Haken-Jochbogenahle



**DO-274**  
200 mm

Curette taglienti  
Scharfe Küretten  
Curettes Tranchantes



COAKLEY  
**DO-285/DO-290**  
170 mm

Fig. 1



**DO-285**

Fig. 2



**DO-286**

Fig. 3



**DO-287**

Fig. 4



**DO-88**

Fig. 5



**DO-89**

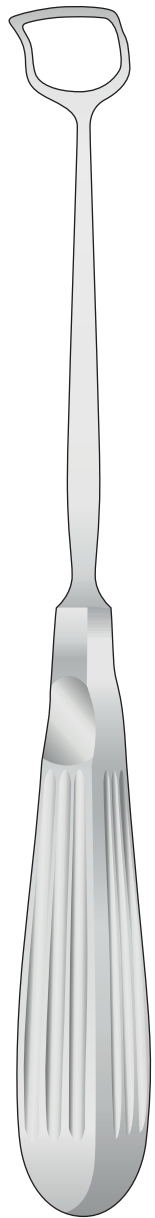
Fig. 6



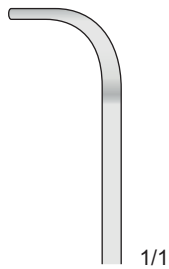
**DO-290**



Adenotomi - Adenotomie - Adenoidectomy  
Adénoïdes - Adenoides

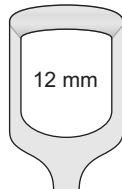


BECKMANN  
BT-84/BT-89  
220 mm



1/1

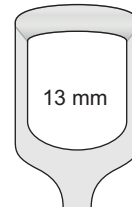
Fig. 1



12 mm

BT-84

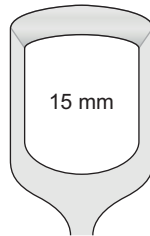
Fig. 2



13 mm

BT-85

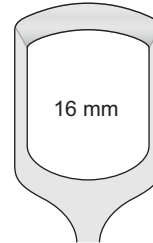
Fig. 3



15 mm

BT-86

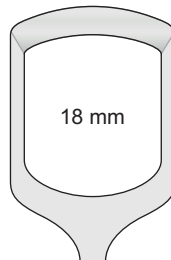
Fig. 4



16 mm

BT-87

Fig. 5



18 mm

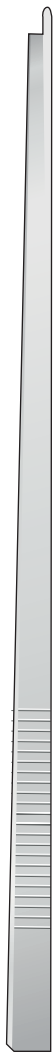
BT-88

Fig. 6

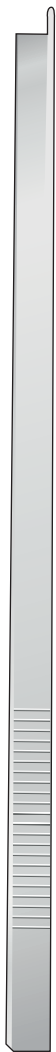


19,5 mm

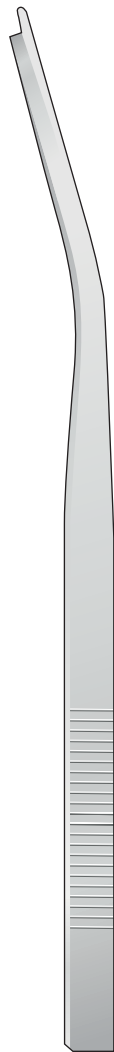
BT-89



**DO-118**  
200 mm



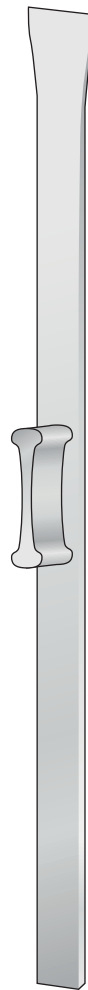
**DO-119**  
200 mm



**DO-84**  
200 mm



**DO-85**  
200 mm



**RUBIN**  
**DO-170/DO-172**  
180 mm

Osteotomi, Osteotomes  
Osteotome, Ostéotomes, Osteótomos



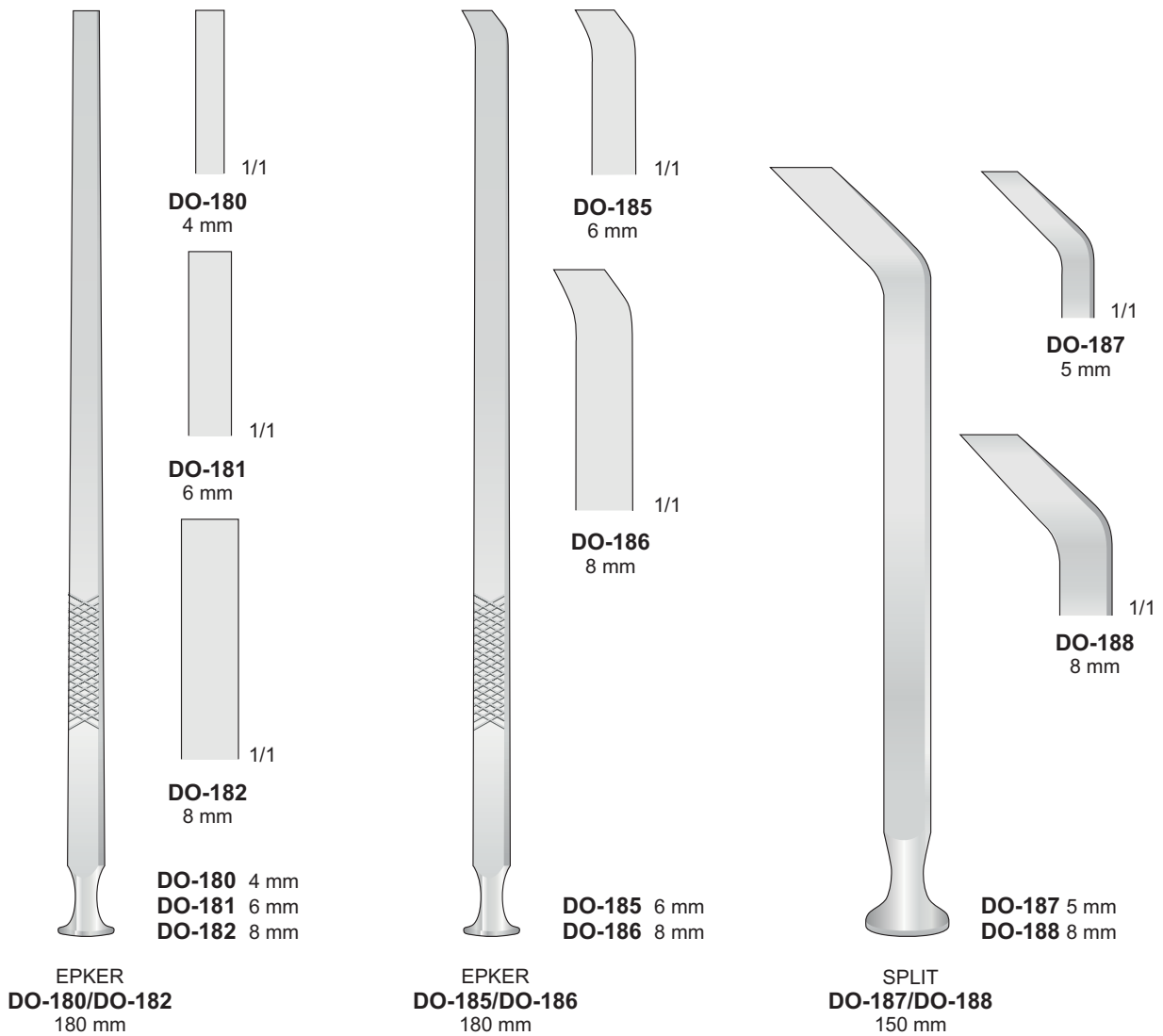
**DO-170**  
10 mm

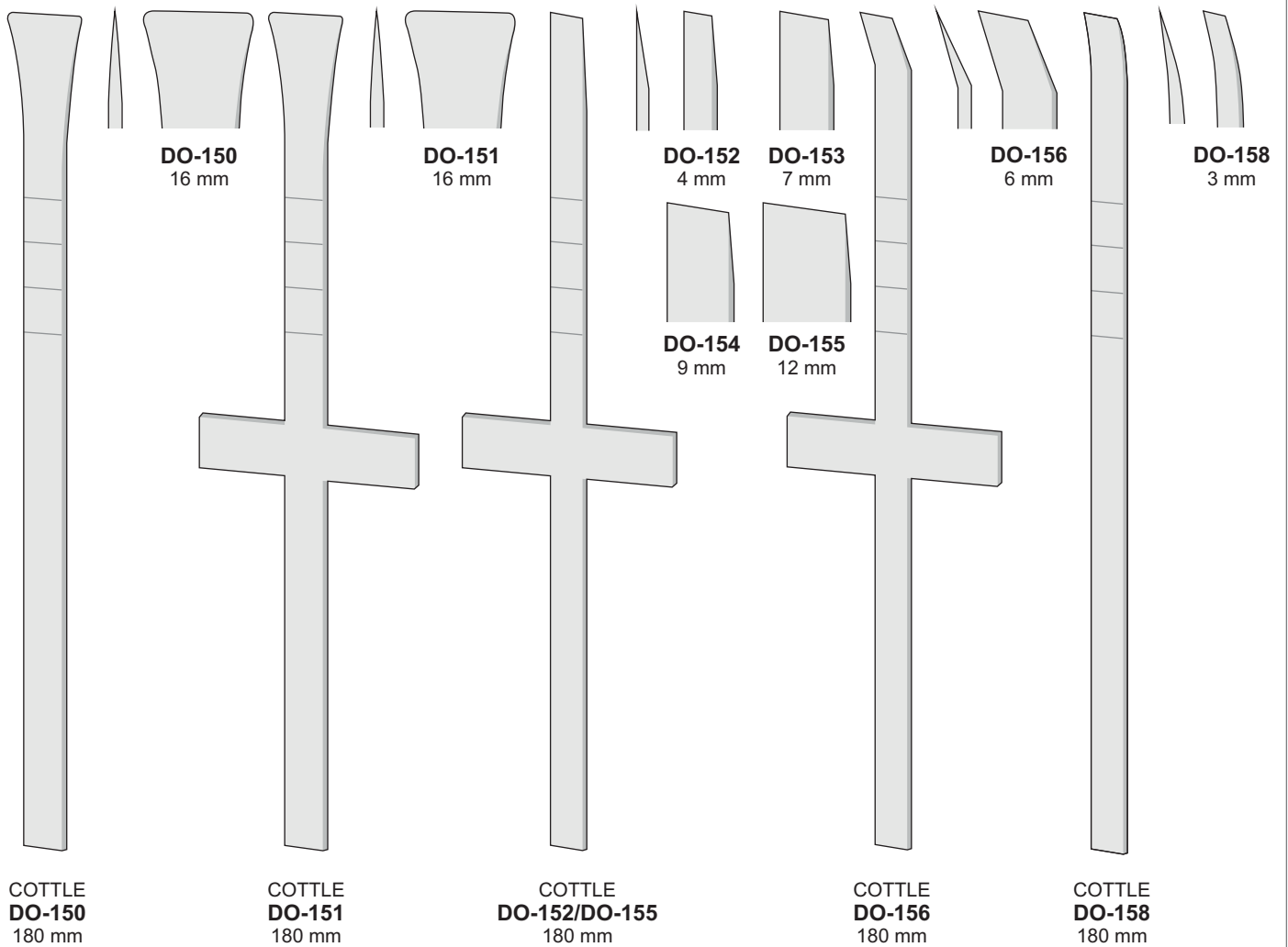


**DO-171**  
12 mm



**DO-172**  
14 mm







Osteotomi

Osteotomes

Osteotome

Ostéotomes

Osteòtoms



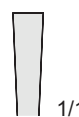
**DO-161**  
3 mm

1/1



**DO-162**  
4 mm

1/1



**DO-163**  
7 mm

1/1



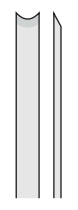
**DO-164**  
9 mm

1/1



**DO-165**  
12 mm

1/1



**DO-166**  
3 mm

1/1

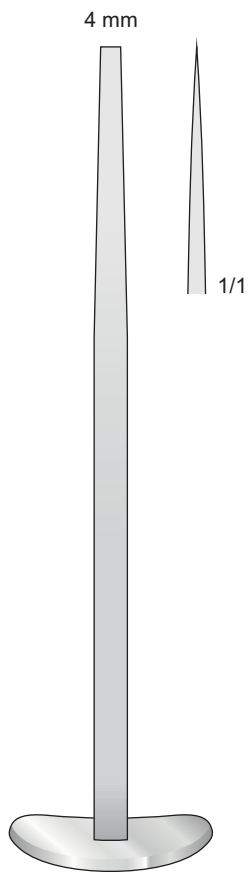


**DO-167**  
4,5 mm

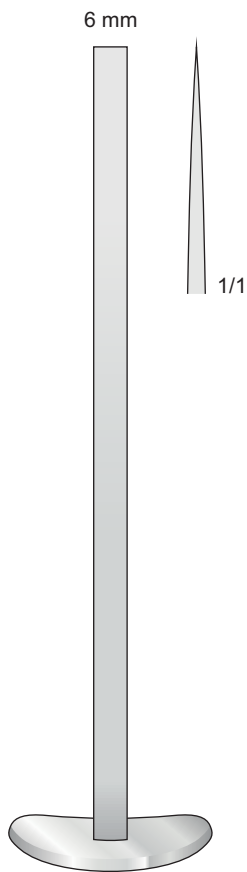
1/1

**DO-161/DO-165**  
190 mm

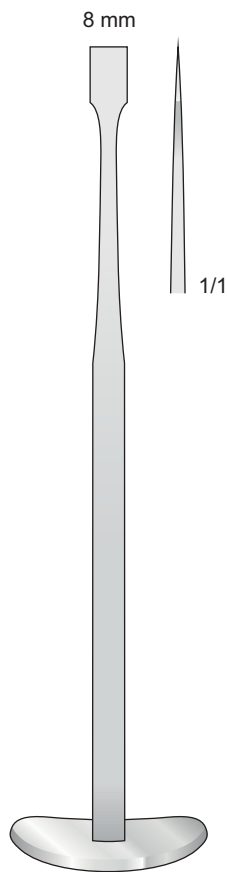
**DO-166/DO-167**  
190 mm



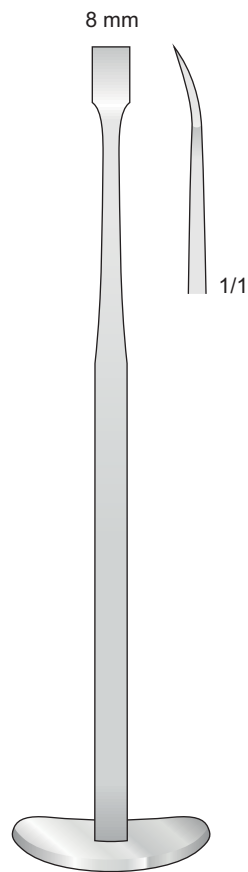
**DO-257**  
165 mm



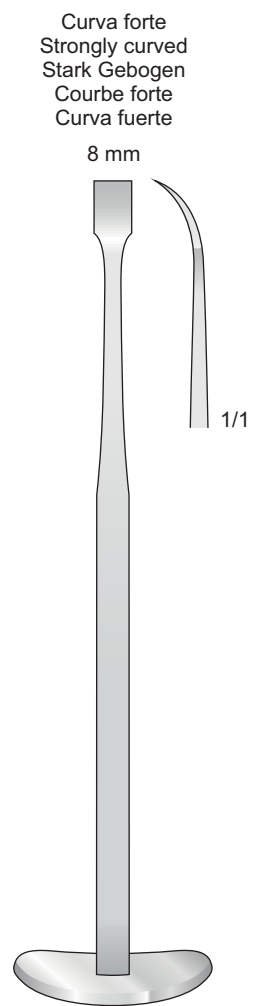
**DO-258**  
165 mm



**DO-203**  
165 mm



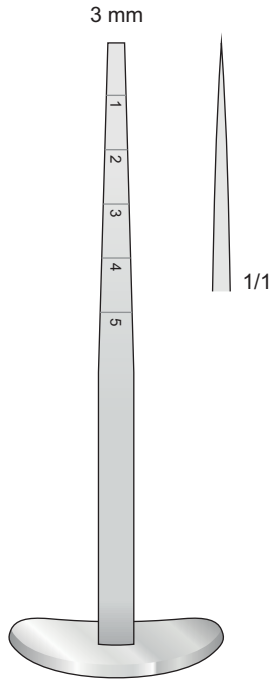
**DO-205**  
165 mm



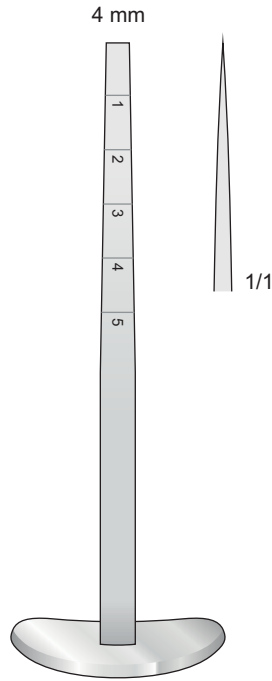
**DAUTREY-MUNRO**  
**DO-206**  
165 mm



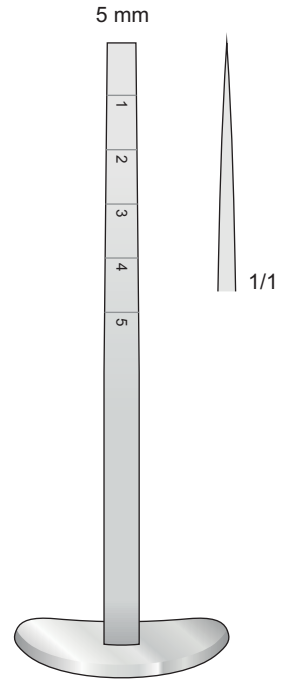
Osteotomi graduati - Osteotomes graduated - Osteotome graduiert  
Ostéotomes graduée - Osteòtoms graduada



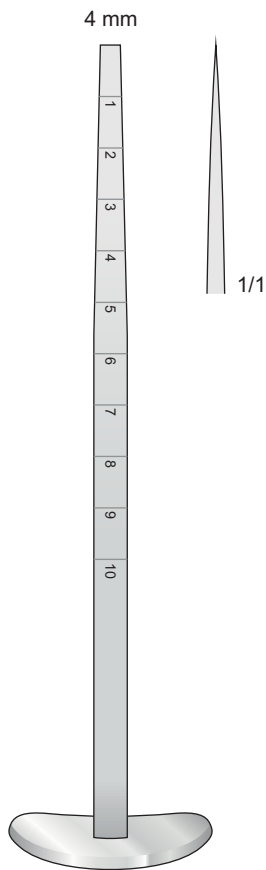
**DO-250**  
115 mm



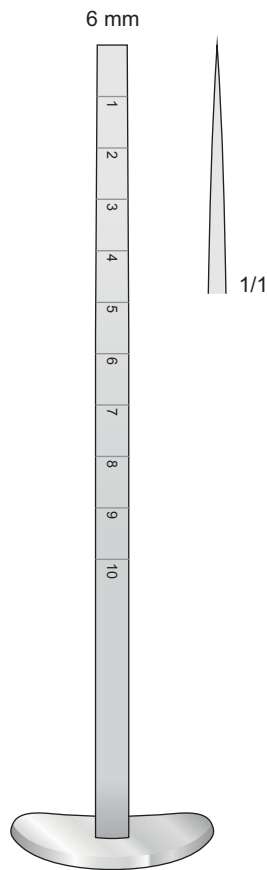
**DO-251**  
115 mm



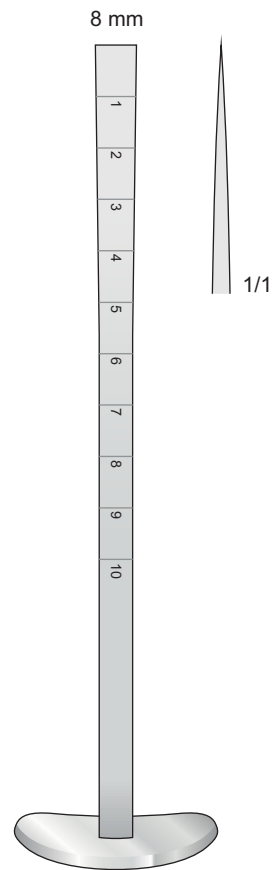
**DO-252**  
115 mm



**DO-260**  
160 mm

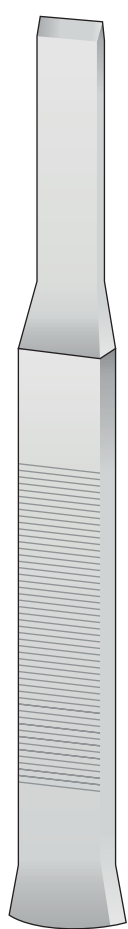


**DO-261**  
160 mm



**DO-262**  
160 mm



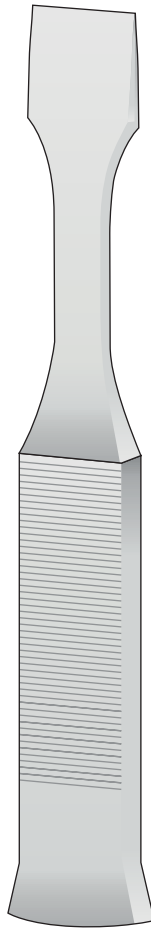


**FL-401**  
10 mm  
**FL-402**  
14 mm  
**FL-403**  
18 mm

TESSIER  
**FL-401/FL-403**  
160 mm



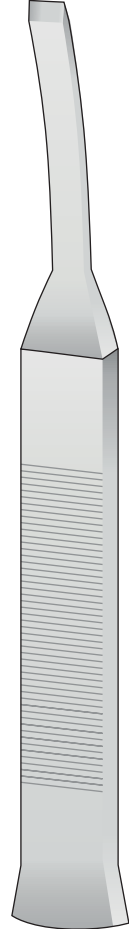
TESSIER  
**FL-404** 10 mm  
160 mm



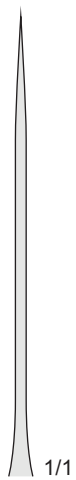
TESSIER  
**FL-405** 18 mm  
160 mm



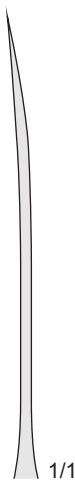
TESSIER  
**FL-410** 3,5 mm  
160 mm



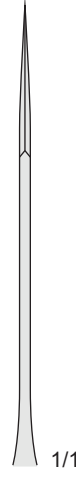
TESSIER  
**FL-411/FL-412**  
160 mm



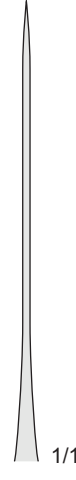
1/1



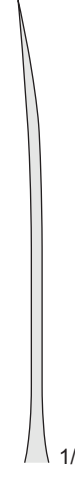
1/1



1/1



1/1



1/1



Manico in ferrozell  
With Ferrozell Handle  
Mit Ferrozell-Griff  
Avec poignée en Ferrozell  
Con mango de Ferrozell

Osteotomi nasali  
Nasal Osteotomes  
Nasen Osteotome  
Ostéotomes nasaux  
Osteotomos nasales

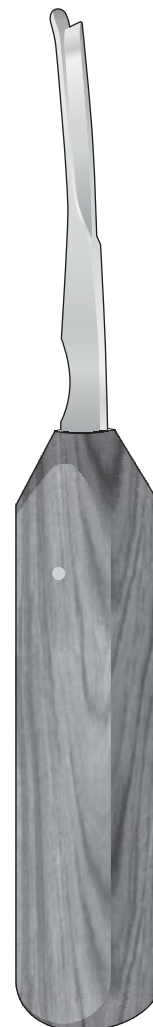
Pterygomaxillary osteotome



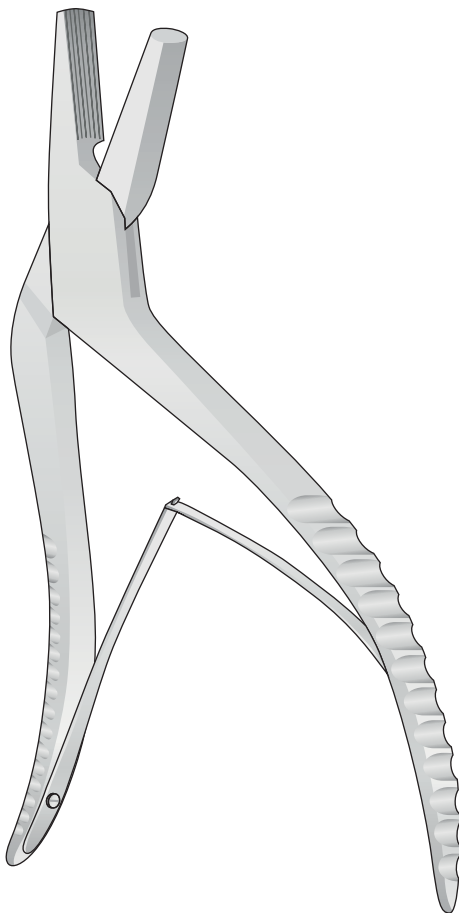
**FL-320**  
170 mm



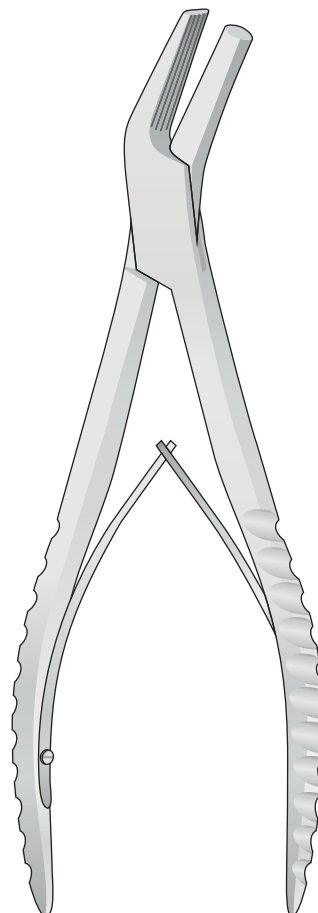
**FL-322**  
190 mm



**FL-323** destro - Right R  
**FL-324** sinistro - Left L  
205 mm



TESSIER  
**FO-136**  
195 mm



TESSIER  
**FO-137**  
220 mm



Macinino per osso - GABON  
 Micro bone mill - GABON  
 Mikro-Knochenmühle - GABON

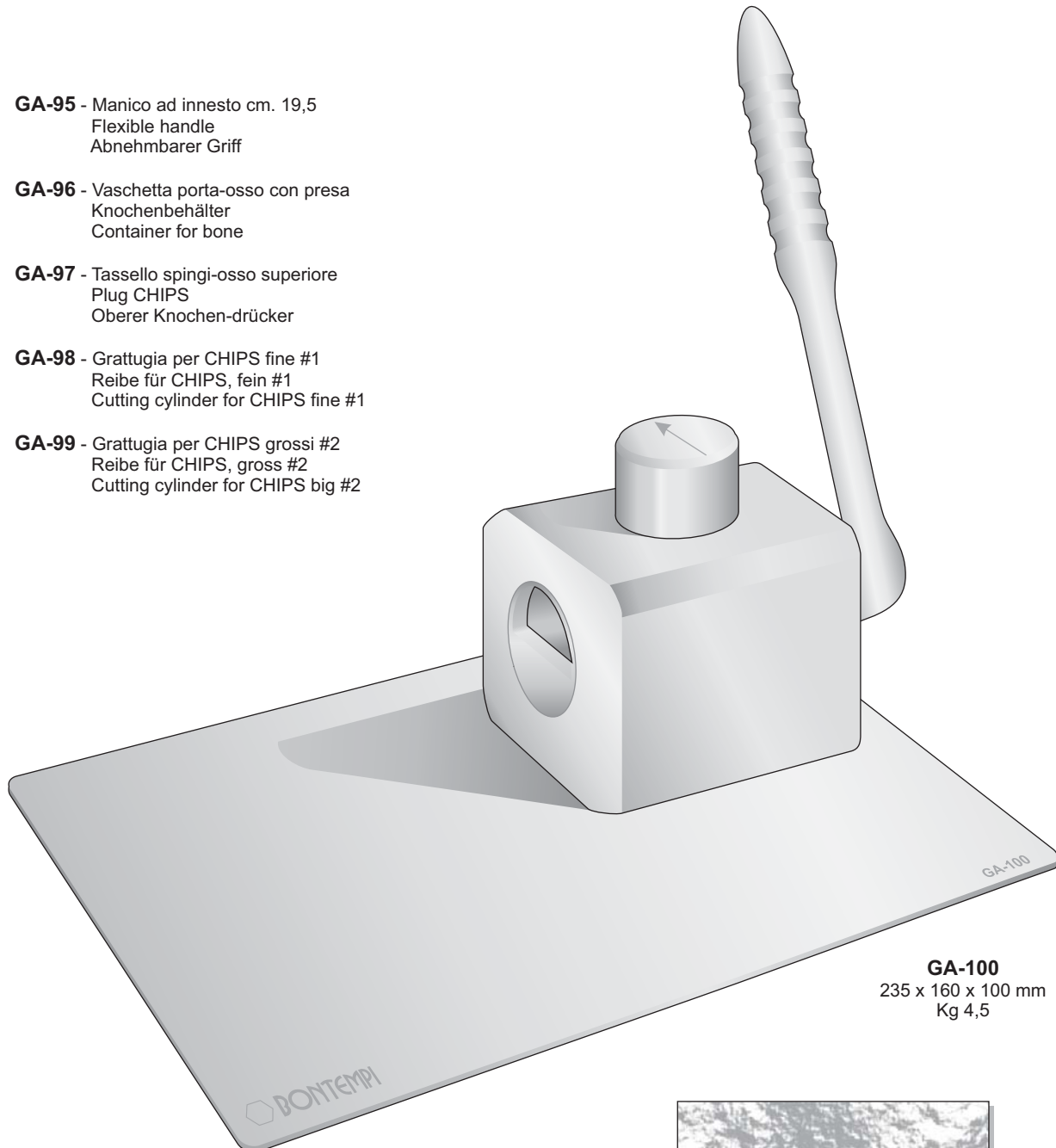
**GA-95** - Manico ad innesto cm. 19,5  
 Flexible handle  
 Abnehmbarer Griff

**GA-96** - Vaschetta porta-osso con presa  
 Knochenbehälter  
 Container for bone

**GA-97** - Tassello spingi-osso superiore  
 Plug CHIPS  
 Oberer Knochen-drücker

**GA-98** - Grattugia per CHIPS fine #1  
 Reibe für CHIPS, fein #1  
 Cutting cylinder for CHIPS fine #1

**GA-99** - Grattugia per CHIPS grossi #2  
 Reibe für CHIPS, gross #2  
 Cutting cylinder for CHIPS big #2



**GA-100**  
 235 x 160 x 100 mm  
 Kg 4,5

**GA-100**  
 Comprende una sola grattugia - **GA-99**  
 With only one cutting cylinder - **GA-99**  
 Mit nur eine Reibe - **GA-99**



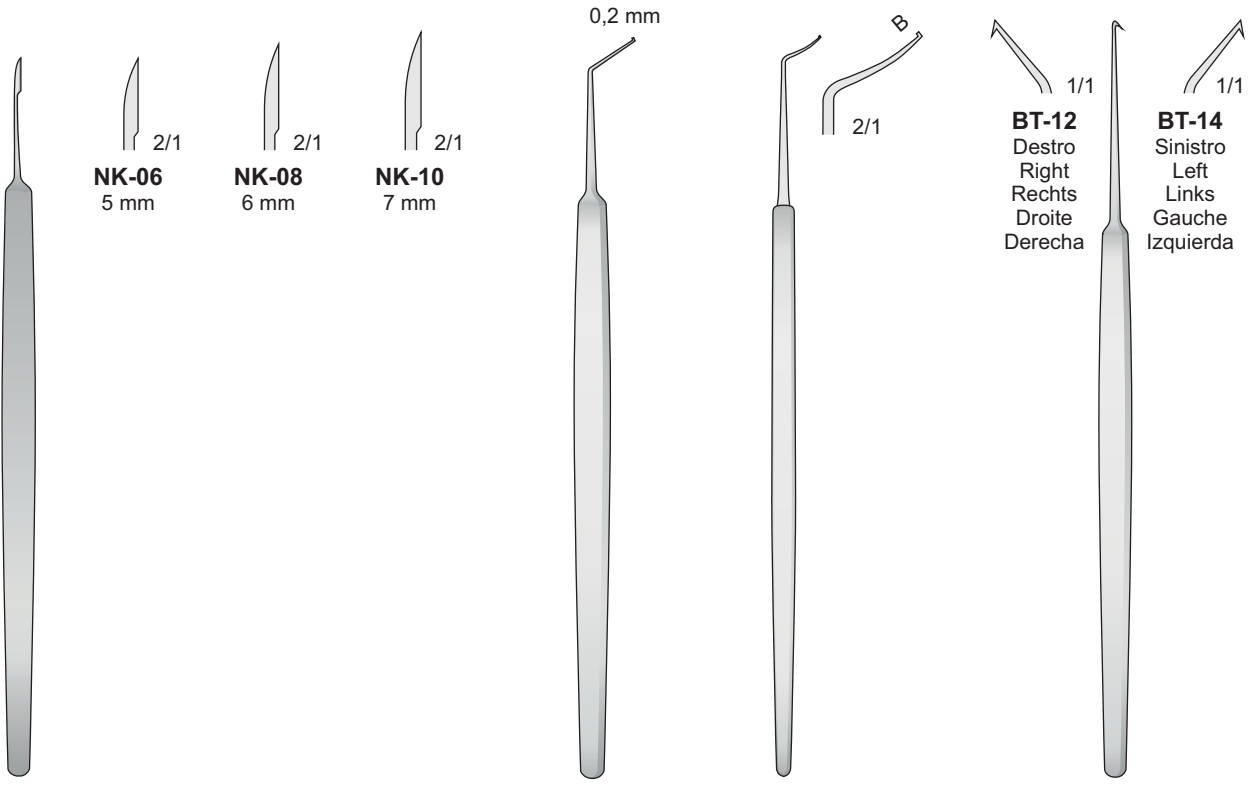
Chips macinato  
 Bone Chips



15

Oftalmologia  
Ophthalmology  
Ophthalmologie  
Ophtalmologie  
Oftalmologia



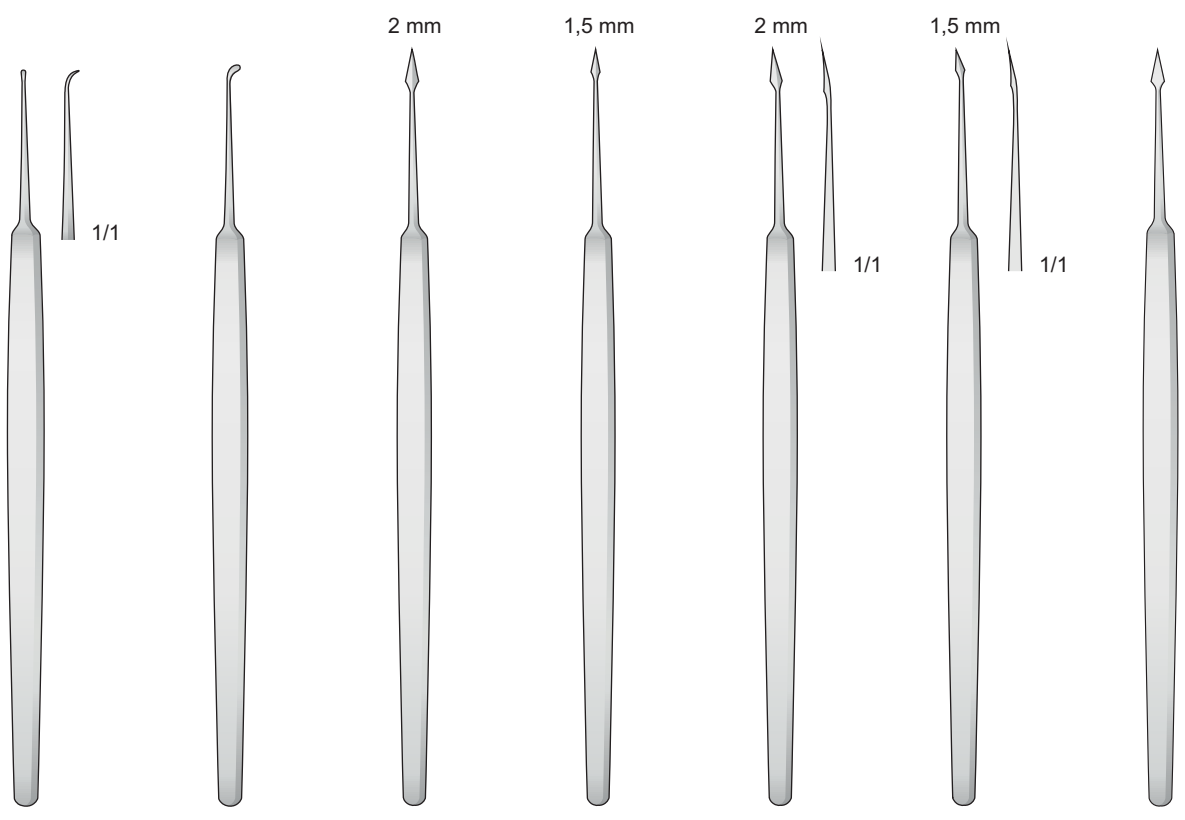


ZIEGLER  
NK-06/NK-10  
115 mm

NK-93  
120 mm

B  
NK-74 0,2 mm  
NK-76 0,3 mm  
125 mm

GRAEFE  
BT-10  
130 mm



LA FORCE  
NK-07  
120 mm

ELLIS  
NK-09  
120 mm

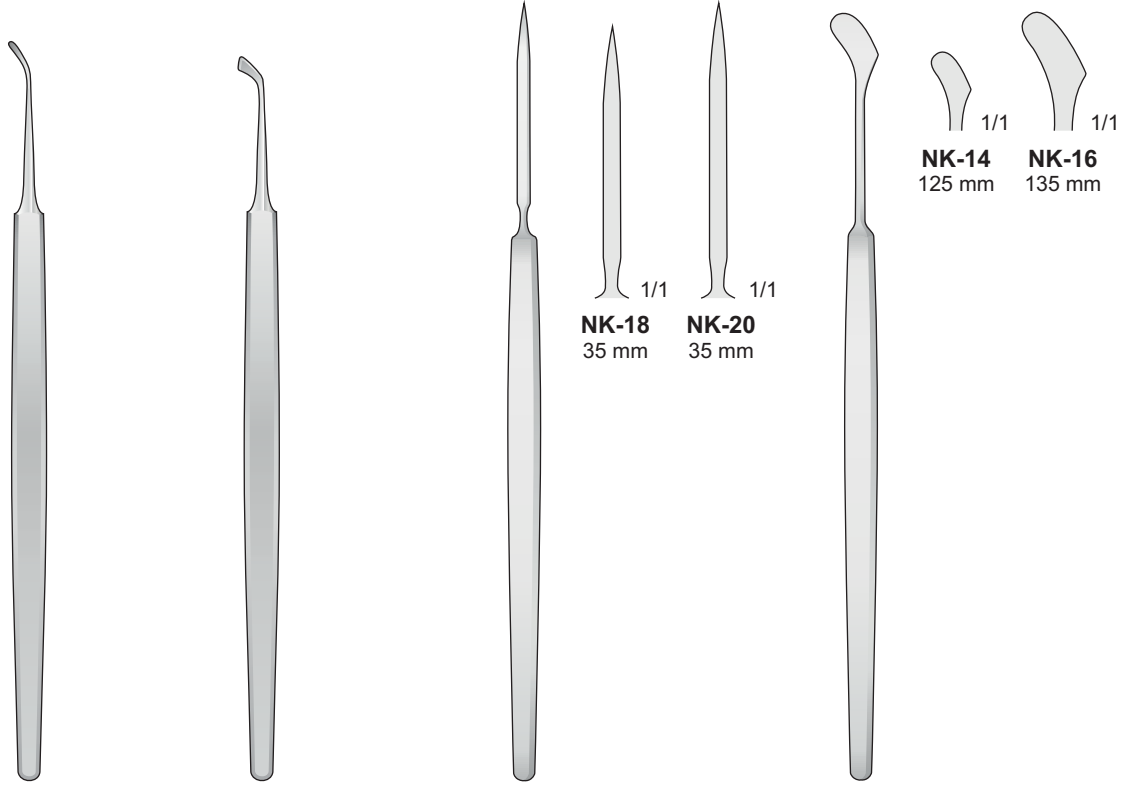
NK-39  
125 mm

NK-19  
125 mm

NK-17  
125 mm

NK-15  
125 mm

NK-49  
125 mm

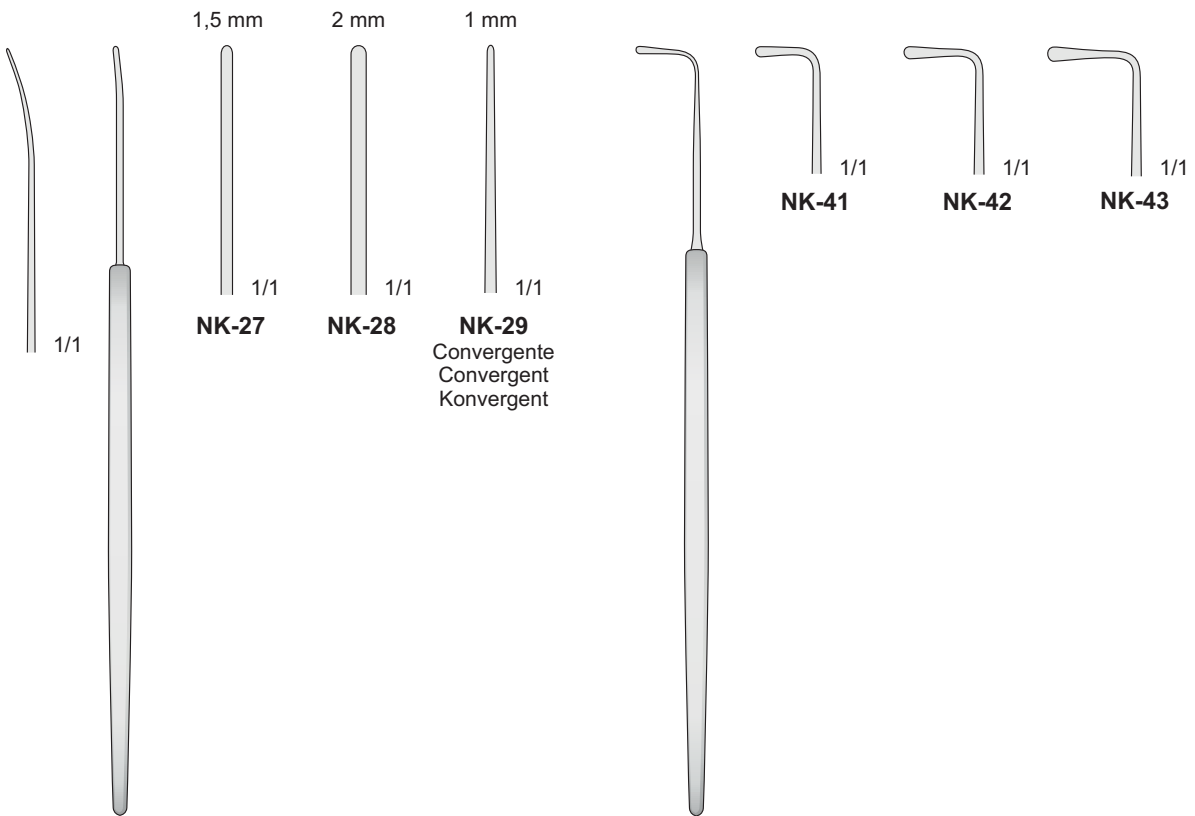


**NK-11**  
125 mm

**NK-13**  
120 mm

GRAEFE  
**NK-18/NK-20**  
140 mm

GRAEFE  
**NK-14/NK-16**



WECKER  
**NK-27/NK-29**  
130 mm

GRAEFE  
**NK-41/NK-43**  
130 mm

**NK-29**  
Convergente  
Convergent  
Konvergent

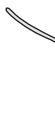




CASTROVIEJO  
NK-21/NK-26



**NK-21**  
130 mm



**NK-22**  
130 mm



**NK-23**  
130 mm



**NK-24**  
130 mm



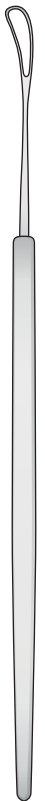
**NK-25**  
130 mm



**NK-26**  
130 mm



1/1



SNELLEN  
**NK-45**  
135 mm



1/1



2/1

**NK-03**  
Sinistro  
Left  
Links  
Gauche  
Izquierda



**NK-03/NK-04**  
140 mm



2/1

**NK-04**  
Destro  
Right  
Rechts  
Droite  
Derecha



**NK-44**  
130 mm



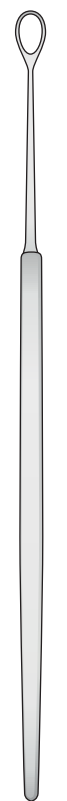
1/1



4 mm



**NK-75**  
130 mm



WEBER  
**NK-46/NK-47**  
135 mm



1/1



1/1



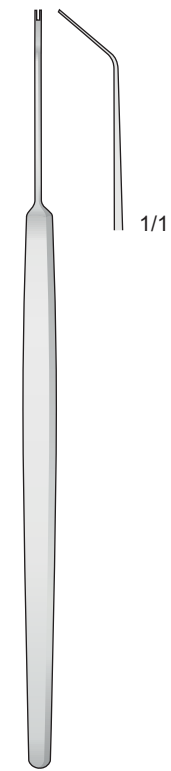
1/1

**NK-46**

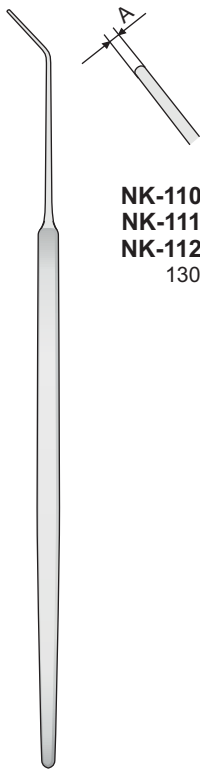
**NK-47**



1,5 mm



**NK-109**  
130 mm



CASTROVIEJO  
**NK-110/NK-112**  
130 mm

A  
**NK-110** 0,6 mm  
**NK-111** 1,0 mm  
**NK-112** 1,5 mm  
130 mm



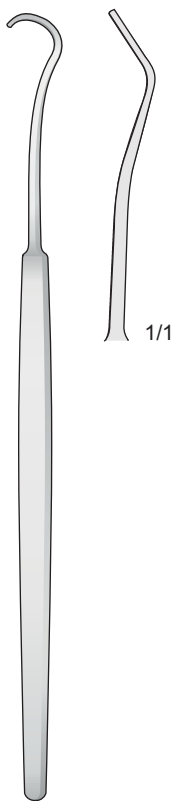
**NK-05**  
140 mm



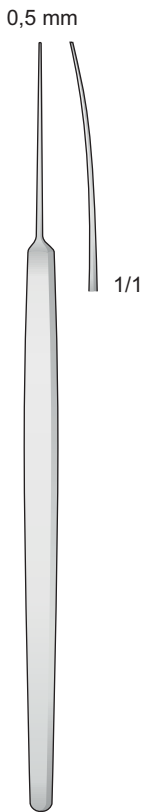
**NK-94**  
165 mm



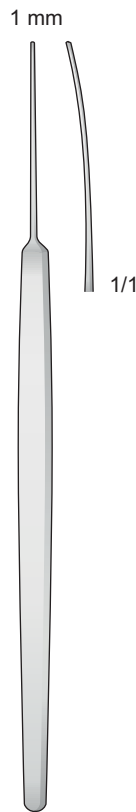
KIMURA  
**NK-48**  
150 mm



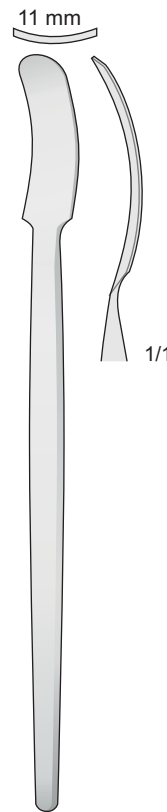
ARRUGA  
**NK-59**  
140 mm



**NK-107**  
130 mm



**NK-108**  
130 mm



**NK-105**  
125 mm

Dilatatori lacrimali  
Tränenkanal Dilatadoren  
Lacrimal dilators  
Dilatadores lacrimales

Fig.1

Fig.2

Fig.3



WILDER  
**NK-97**  
100 mm



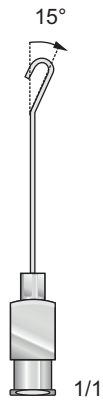
WILDER  
**NK-98**  
100 mm



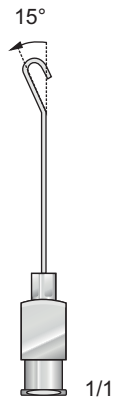
WILDER  
**NK-99**  
100 mm



Cannule di irrigazione  
Irrigating cannulas  
Spülkanülen  
Canules d'irrigation  
Cánulas de irrigación



**OL-51**  
45 mm



**OL-52**  
45 mm

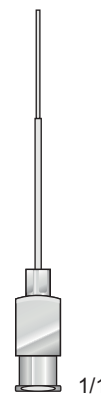


**OL-50**  
30 mm



**OL-53**  
35 mm

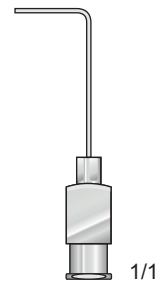
Ø 0,5 mm



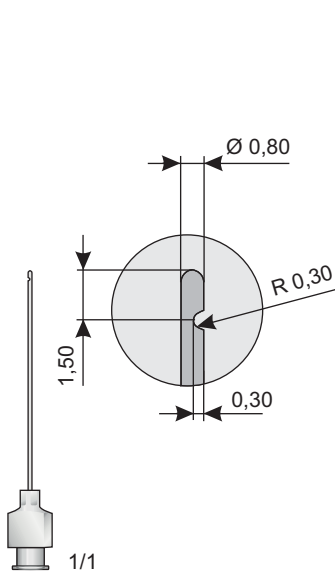
**OL-54**  
50 mm



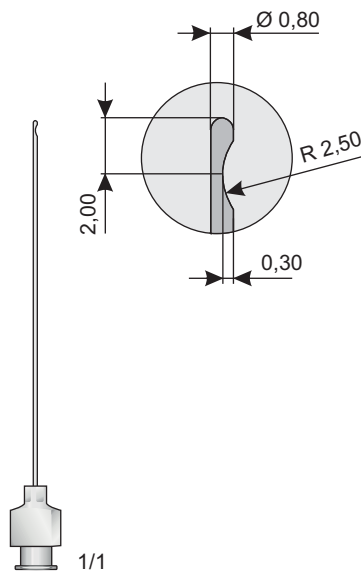
**ANEL  
OL-55**  
30 mm



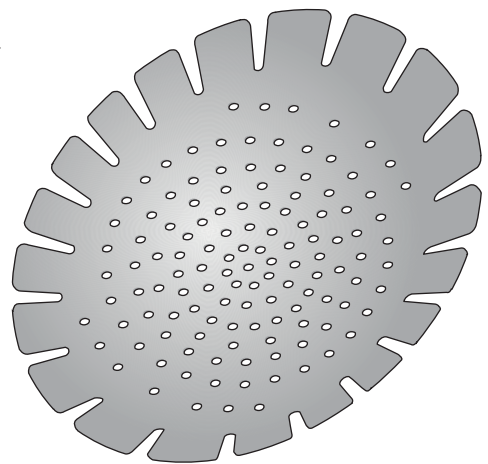
**ANEL  
OL-56**  
30 mm



**OL-57**  
40 mm



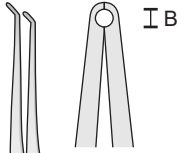
**OL-58**  
60 mm



**OL-20**  
75 mm

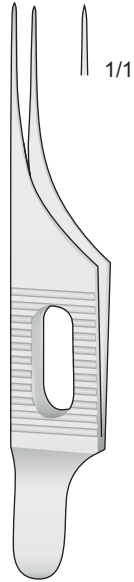


Micro Pinzette - Micro Forceps - Mikro Pinzetten - Micro pinces - Pinzas finos



**B**  
**NK-61** 0,2 mm  
**NK-62** 0,3 mm  
**NK-63** 0,4 mm

PIERSE  
**NK-61/NK-63**  
 80 mm



COLIBRI  
**NK-64**  
 80 mm



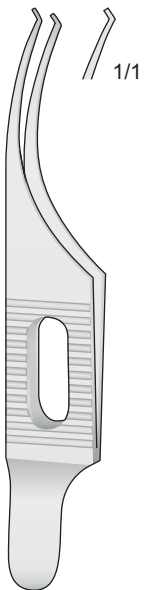
**A**  
**NK-65** 0,25 mm  
**NK-66** 0,4 mm  
**NK-67** 0,6 mm

COLIBRI  
**NK-65/NK-67**  
 75 mm



**A**  
**NK-69** 0,25 mm  
**NK-70** 0,4 mm  
**NK-71** 0,6 mm

COLIBRI  
**NK-69/NK-71**  
 80 mm



COLIBRI  
**NK-60**  
 80 mm

⌀ 5/1



**NK-73**  
 70 mm



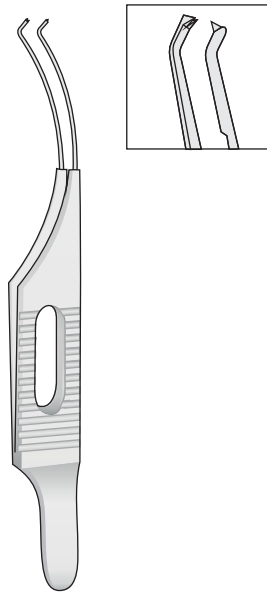
**L**  
**NK-87** 8 mm  
**NK-88** 10 mm  
**NK-89** 12 mm

**NK-87/NK-89**  
 70 mm

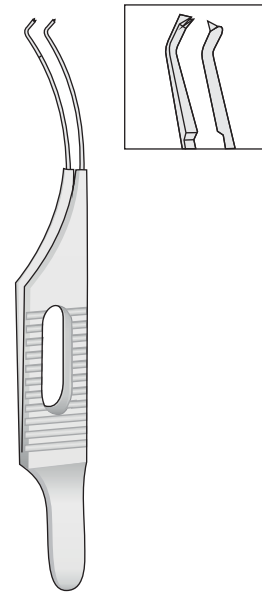


**L**  
**NK-77** 8 mm  
**NK-78** 10 mm

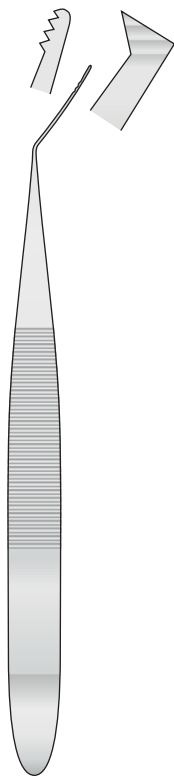
**NK-77/NK-78**  
 70 mm



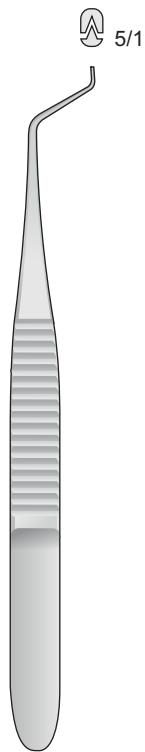
BARRAQUER  
NK-401  
75 mm



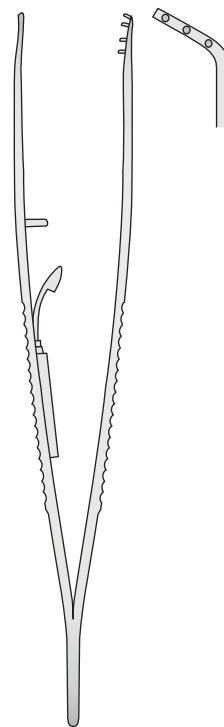
BARRAQUER  
NK-403  
75 mm



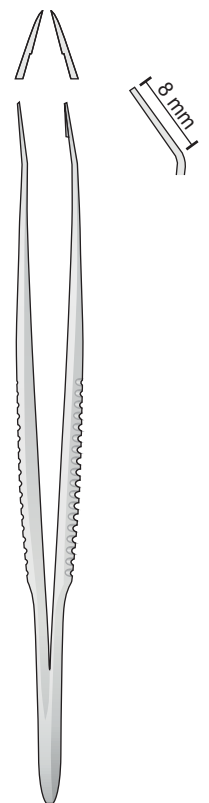
FD-118  
95 mm



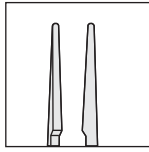
FD-119  
90 mm



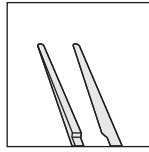
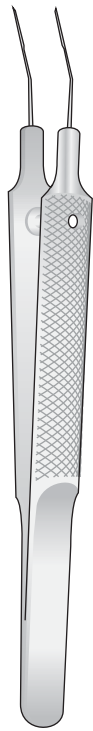
FD-120  
95 mm



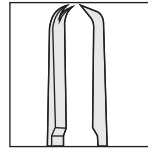
Mc PHERSON  
FD-123  
95 mm



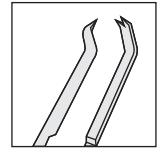
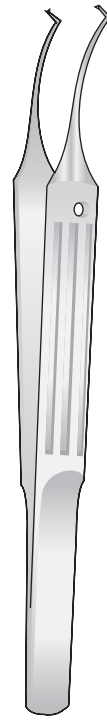
**MF-150**  
100 mm



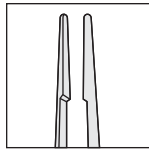
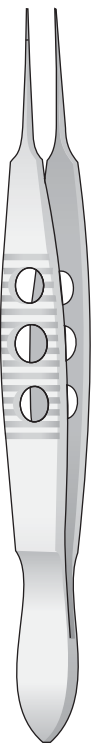
**MF-151**  
100 mm



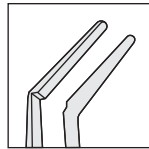
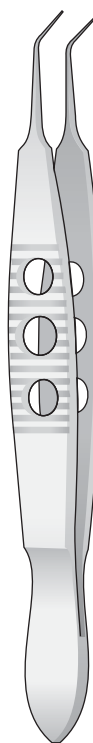
**CASTROVIEJO**  
**MF-245**  
110 mm



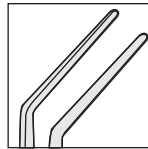
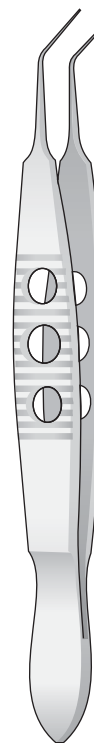
**TROUTMAN**  
**MF-246**  
110 mm



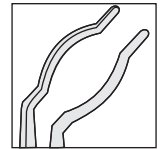
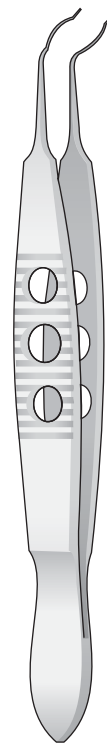
**MC PHERSON**  
**MF-231**  
105 mm



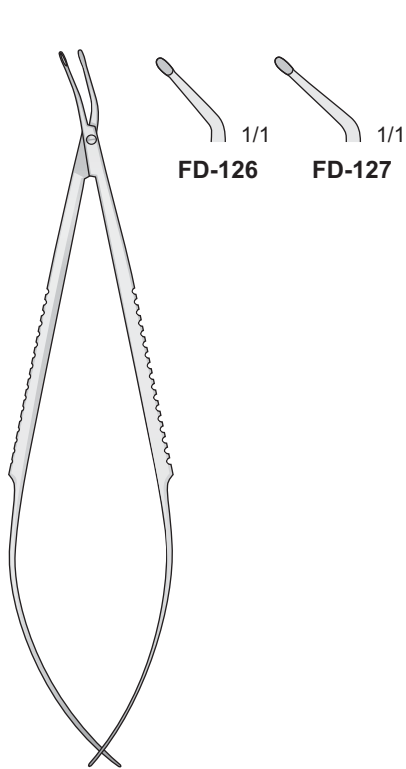
**MC PHERSON**  
**MF-232**  
105 mm



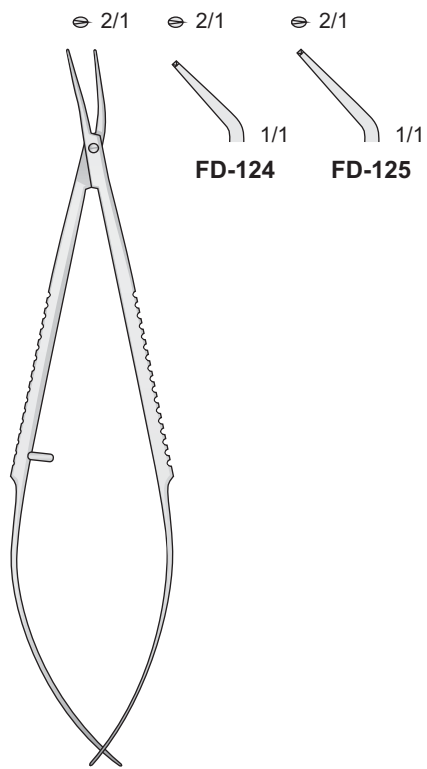
**FAULKNER**  
**MF-278**  
105 mm



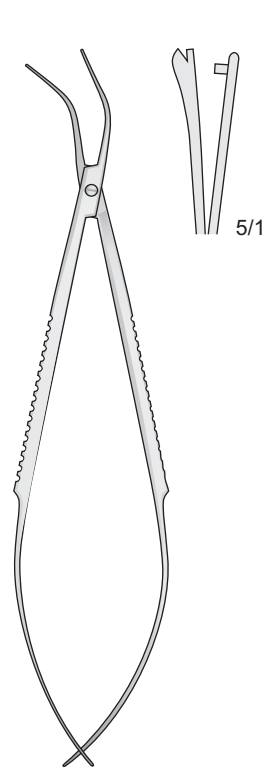
**OSHIKA-FAULKNER**  
**MF-279**  
105 mm



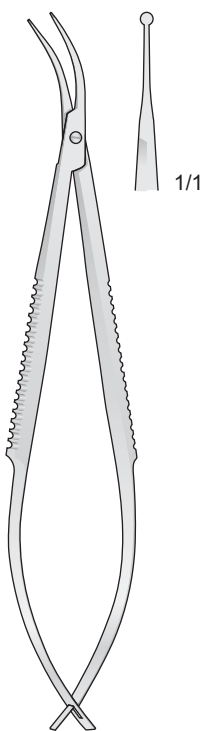
**FD-126/FD-127**  
110 mm



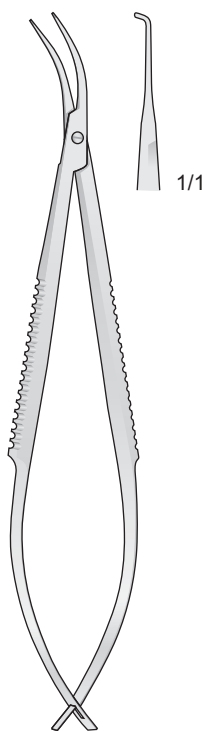
**FD-124/FD-125**  
110 mm



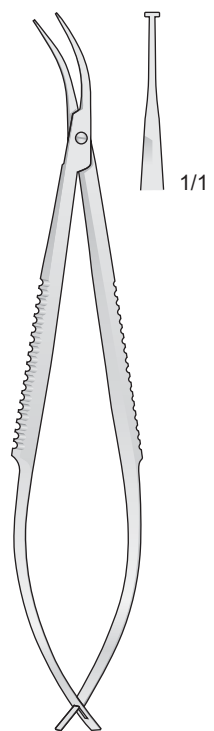
**FD-130**  
110 mm



**FD-132**  
110 mm



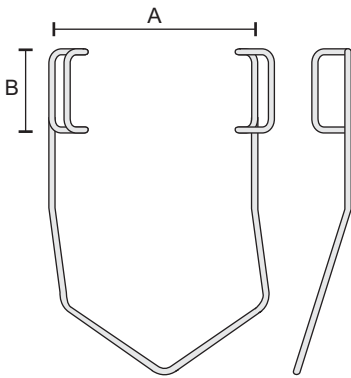
**FD-134**  
110 mm



**FD-136**  
110 mm



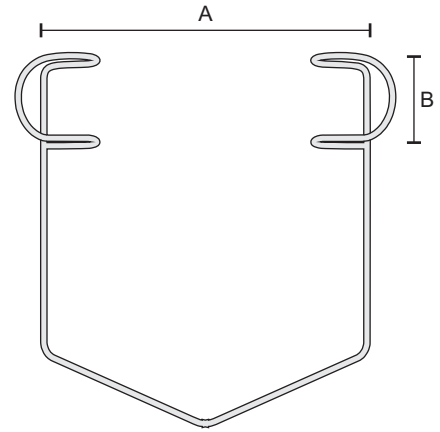
Blefarostati - Eye specula - Sperrelevatoren  
Blèpharostats - Blefarostatos



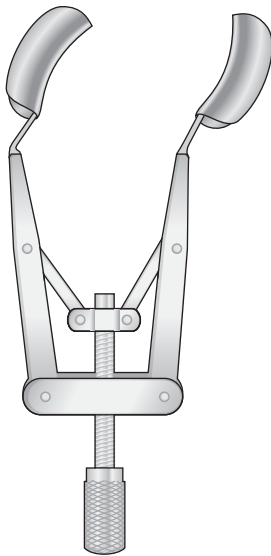
**NK-79**    A    B  
27 mm   11 mm



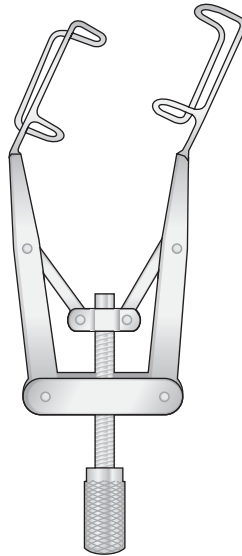
**BARRAQUER**  
**NK-83**



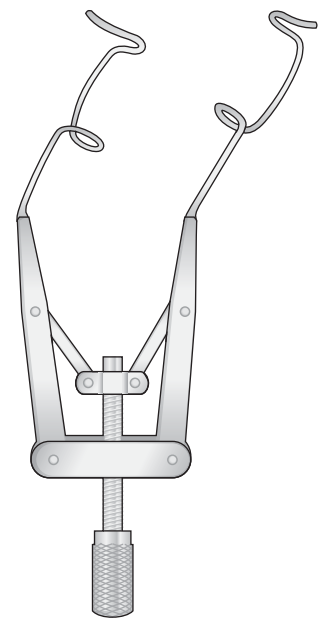
	A	B
<b>NK-80</b>	27 mm	5 mm
<b>NK-82</b>	34 mm	9 mm
<b>NK-84</b>	42 mm	12 mm
<b>NK-86</b>	42 mm	14 mm



**KERSHNER**  
**NK-420**



**KERSHNER**  
**NK-421**

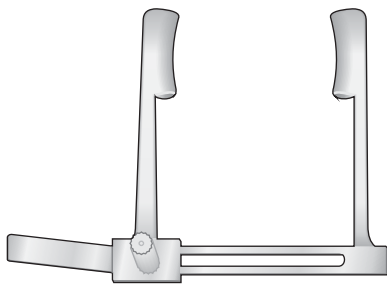


**LIEBERMANN-TENNANT**  
**NK-422**

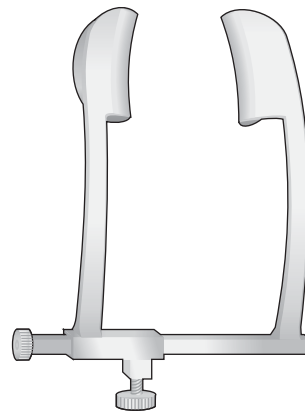




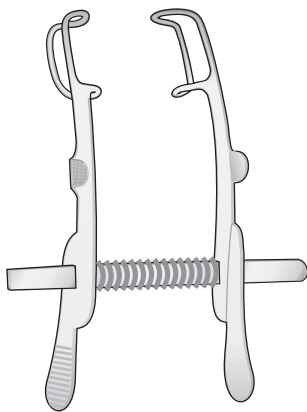
Blefarostati - Eye specula - Sperrelevatoren  
Blèpharostats - Blefarostatos



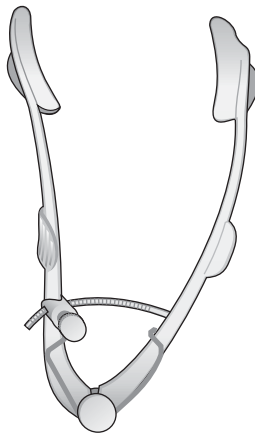
PROST  
NK-92



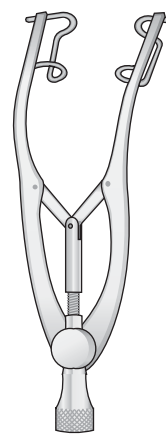
COOK  
NK-131



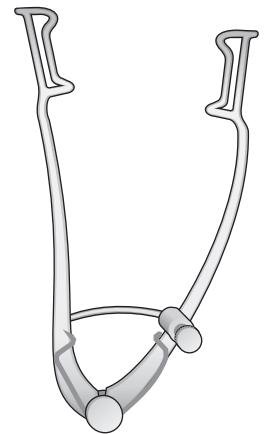
MELLINGER  
BV-02  
70 mm



LISTER-BURCH  
BV-04  
80 mm



CASTROVIEJO  
BV-05  
80 mm



WILLIAMS  
BV-06  
80 mm



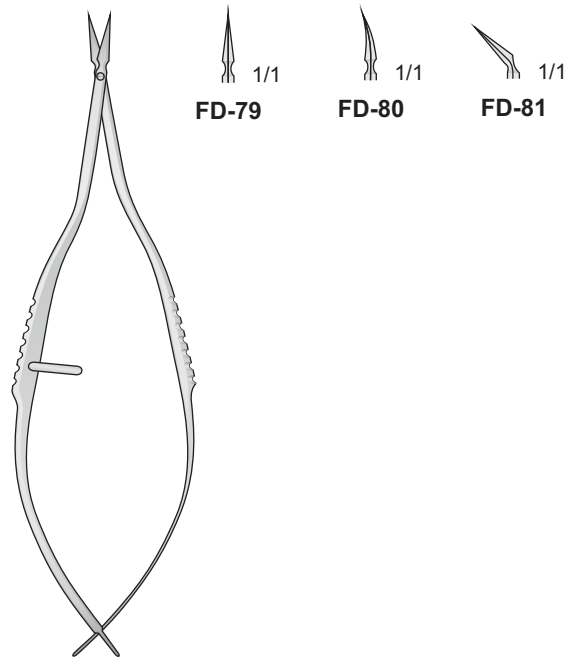
Micro forbici

Micro scissors

Micro Scheren

Micro ciseaux

Micro tijeras



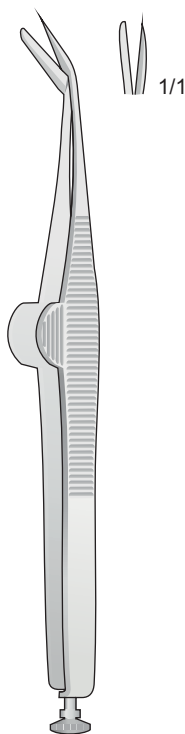
FD-79

FD-80

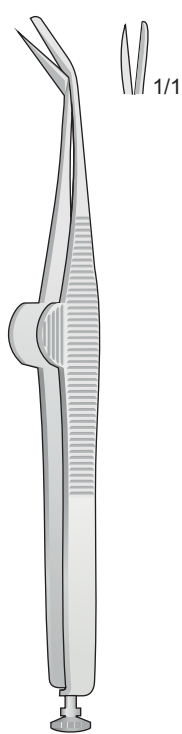
FD-81

VANNAS  
FD-79/FD-81  
85 mm

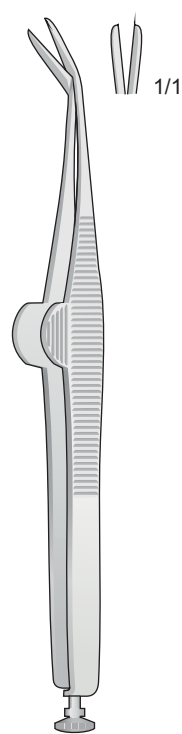
Iris Scissors



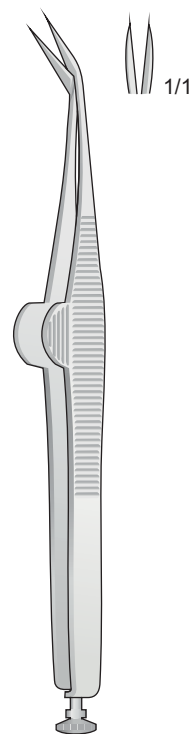
WECKER  
FD-231  
110 mm



WECKER  
FD-232  
110 mm



WECKER  
FD-233  
110 mm



WECKER  
FD-234  
110 mm



Micro forbici

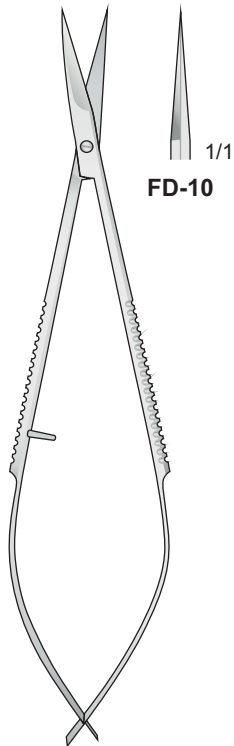
Micro scissors

Micro Scheren

Micro ciseaux

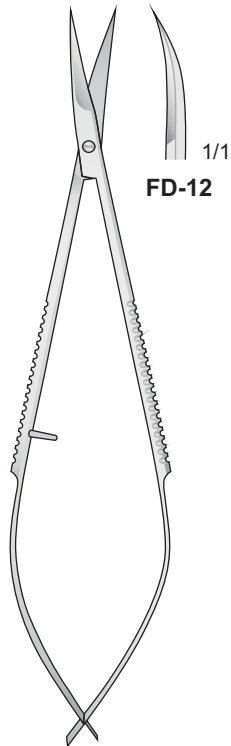
Micro tijeras

Acuta - Sharp - Spitz  
Pointu - Agudas



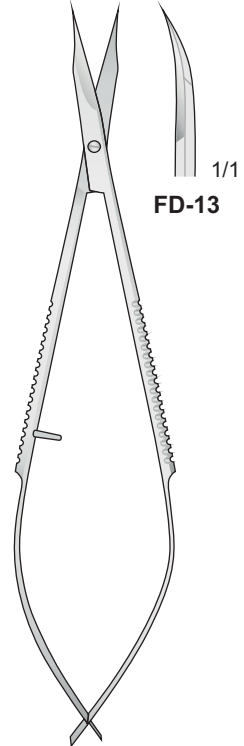
NOYES  
**FD-10**  
120 mm

Acuta - Sharp - Spitz  
Pointu - Agudas



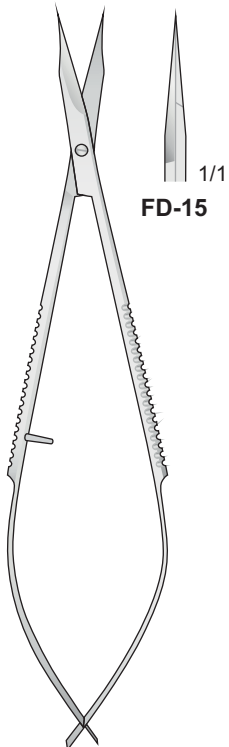
NOYES  
**FD-12**  
120 mm

Acuta - Sharp - Spitz  
Pointu - Agudas



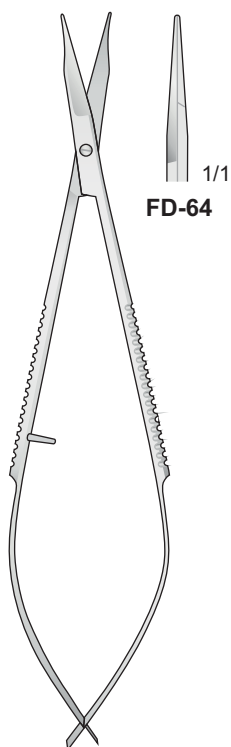
WESTCOTT  
**FD-13**  
120 mm

Acuta - Sharp - Spitz  
Pointu - Agudas



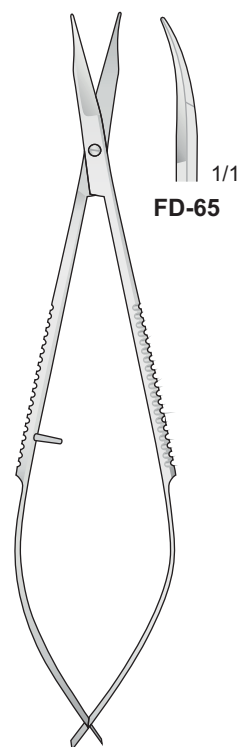
WESTCOTT  
**FD-15**  
120 mm

Smussa - Blunt - Stumpf  
Mousse - Romas



WESTCOTT  
**FD-64**  
120 mm

Smussa - Blunt - Stumpf  
Mousse - Romas



WESTCOTT  
**FD-65**  
120 mm



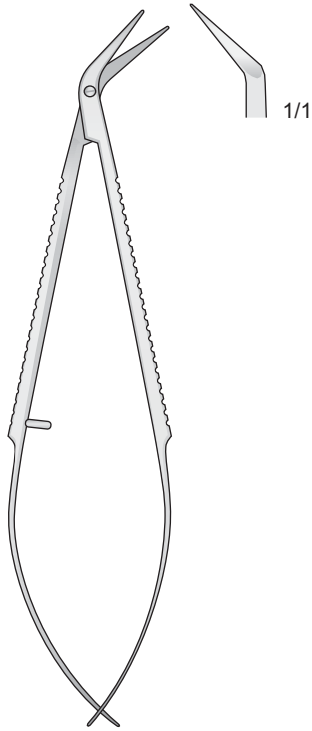
Micro forbici

Micro scissors

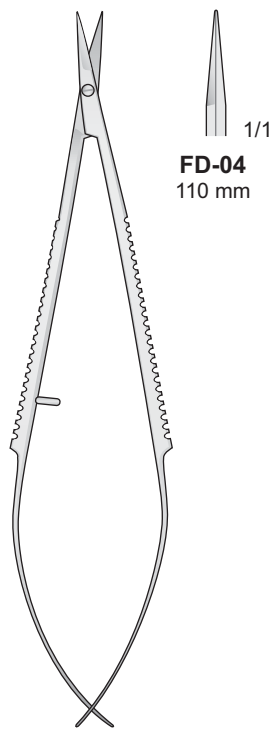
Micro Scheren

Micro ciseaux

Micro tijeras

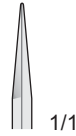


**FD-03**  
110 mm



**FD-04/FD-05**  
110 mm

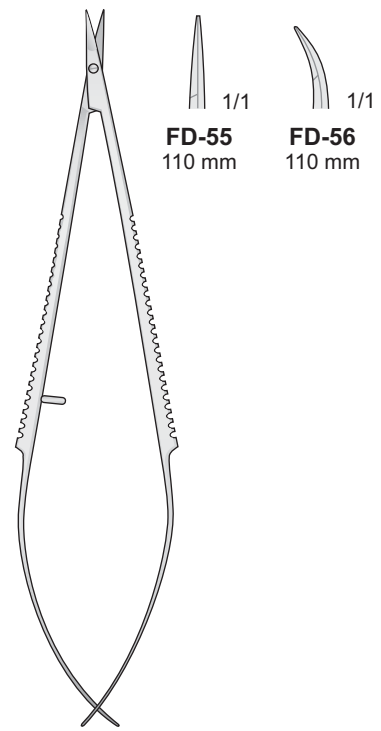
Acuta - Sharp  
Spitz - Pointu - Agudas



**FD-04**  
110 mm



**FD-05**  
110 mm



**FD-55/FD-56**  
110 mm

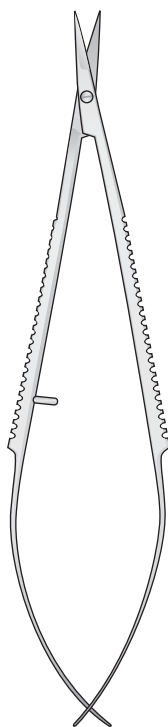
Acuta - Sharp  
Spitz - Pointu - Agudas



**FD-55**  
110 mm



**FD-56**  
110 mm



**FD-49/FD-50**  
110 mm

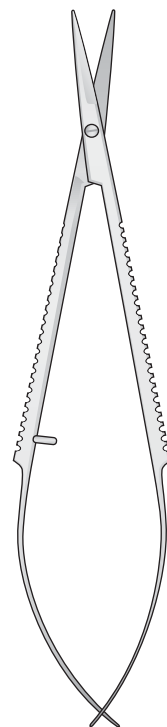
Smussa - Blunt  
Stumpf - Mousse - Romas



**FD-49**  
110 mm



**FD-50**  
110 mm



**FD-41/FD-42**  
120 mm

Smussa - Blunt  
Stumpf - Mousse - Romas



**FD-41**  
120 mm



**FD-42**  
120 mm



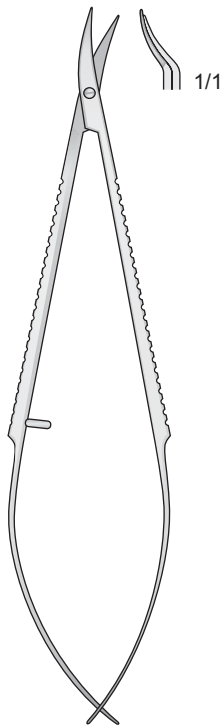
Micro forbici

Micro scissors

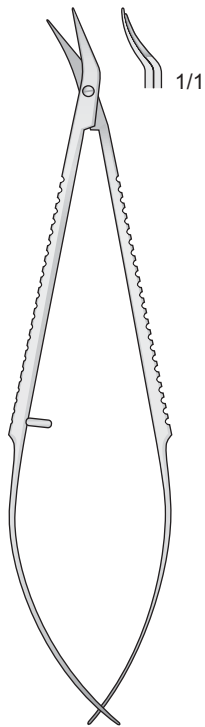
Micro Scheren

Micro ciseaux

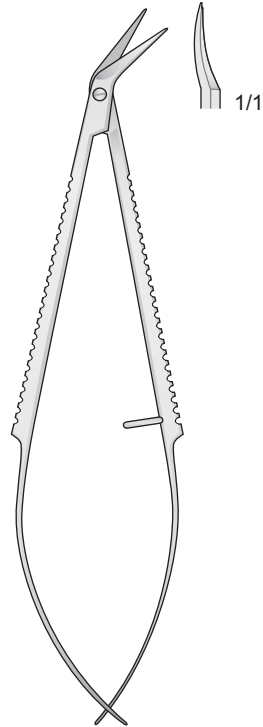
Micro tijeras



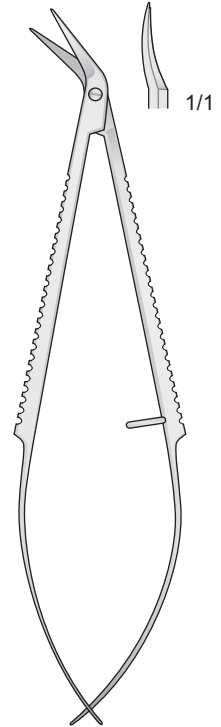
TROUTMAN  
FD-69  
110 mm



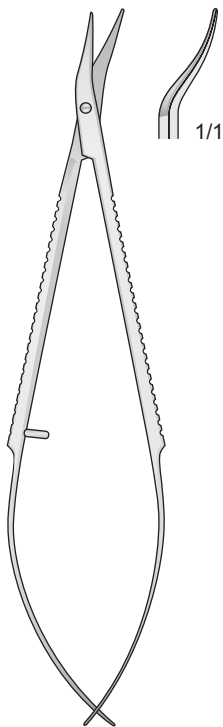
TROUTMAN  
FD-70  
110 mm



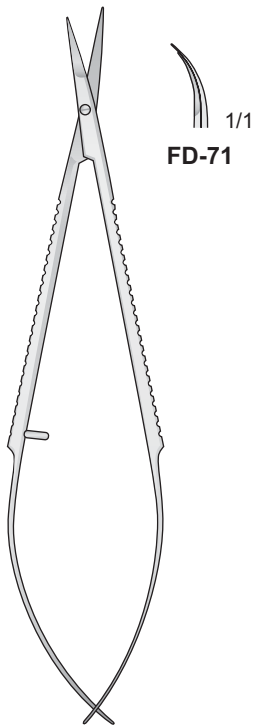
CASTROVIEJO  
FD-66  
110 mm



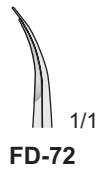
CASTROVIEJO  
FD-67  
110 mm



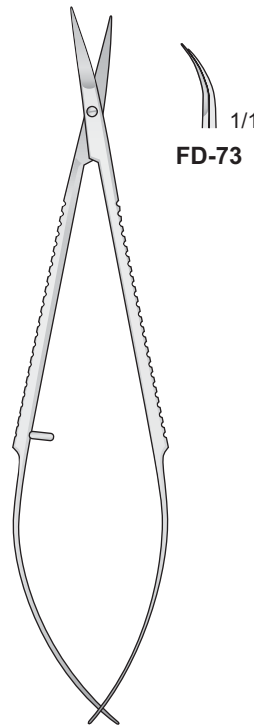
CASTROVIEJO  
FD-68  
110 mm



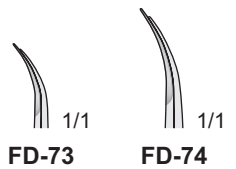
FD-71/FD-72  
110 mm



FD-72



FD-73/FD-74  
110 mm



FD-73



FD-74



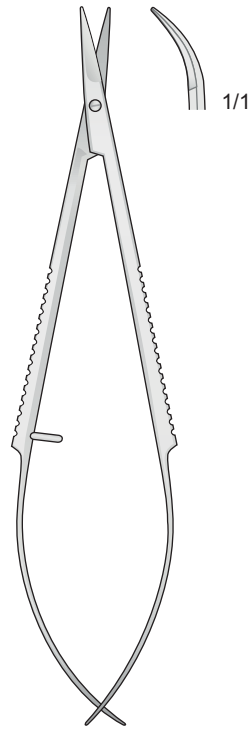
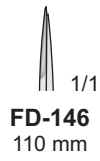
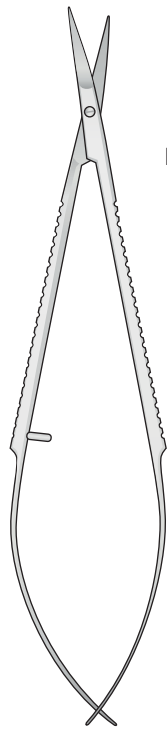
Micro forbici

Micro scissors

Micro Scheren

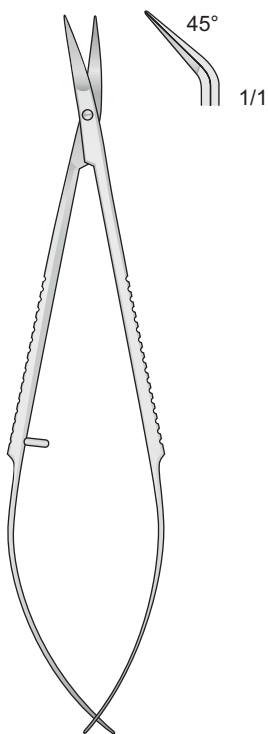
Micro ciseaux

Micro tijeras

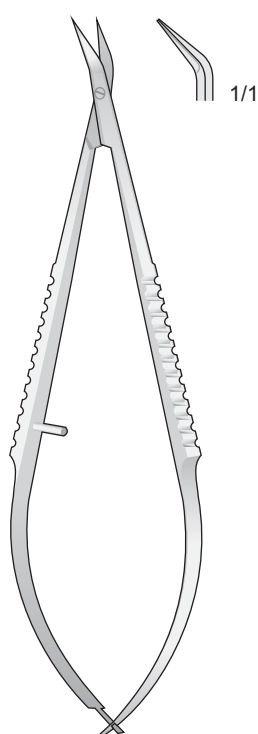


**FD-146/FD-147**

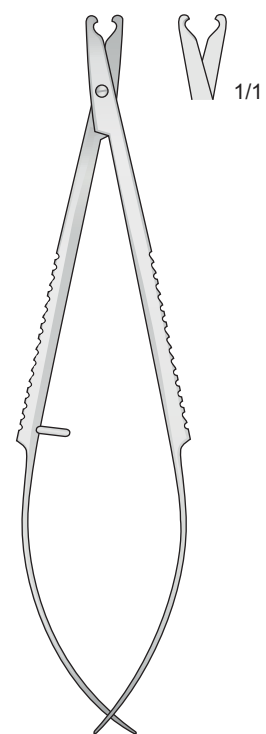
**FD-62**  
110 mm



**FD-11**  
110 mm



**FD-235**  
110 mm



**FD-61**  
110 mm



Micro forbici

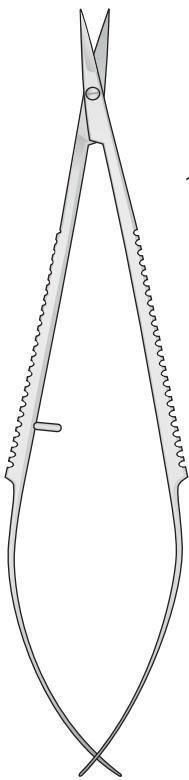
Micro scissors

Micro Scheren

Micro ciseaux

Micro tijeras

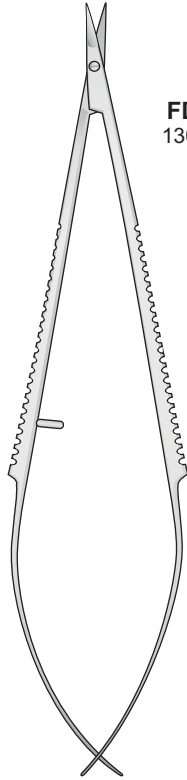
Acuta - Sharp - Spitz - Pointu - Agudas



1/1  
**FD-01**  
130 mm

1/1  
**FD-02**  
130 mm

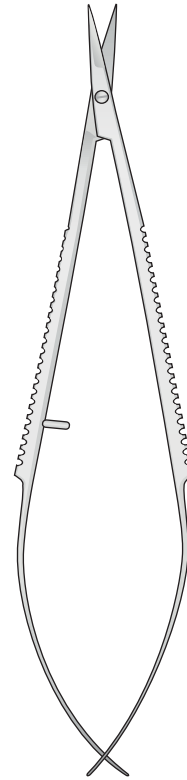
Acuta - Sharp - Spitz - Pointu - Agudas



1/1  
**FD-57**  
130 mm

1/1  
**FD-58**  
130 mm

Smussa - Blunt - Stumpf - Mousse - Romas



1/1  
**FD-51**  
130 mm

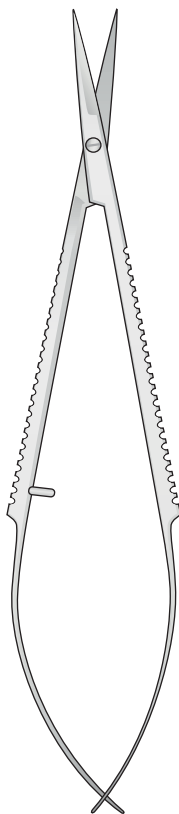
1/1  
**FD-52**  
130 mm

**FD-01/FD-02**  
130 mm

**FD-57/FD-58**  
130 mm

**FD-51/FD-52**  
130 mm

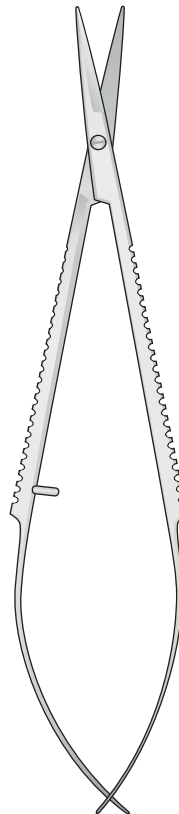
Acuta - Sharp - Spitz - Pointu - Agudas



1/1  
**FD-07**  
135 mm

1/1  
**FD-09**  
135 mm

Smussa - Blunt - Stumpf - Mousse - Romas



1/1  
**FD-43**  
135 mm

1/1  
**FD-44**  
135 mm

**FD-07/FD-09**  
135 mm

**FD-43/FD-44**  
135 mm



Micro forbici

Micro scissors

Micro Scheren

Micro ciseaux

Micro tijeras

Acuta - Sharp  
Spitz - Pointu - Agudas



1/1



1/1

**FD-59**  
160 mm

**FD-60**  
160 mm



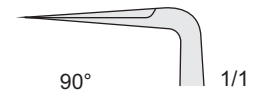
1/1



1/1

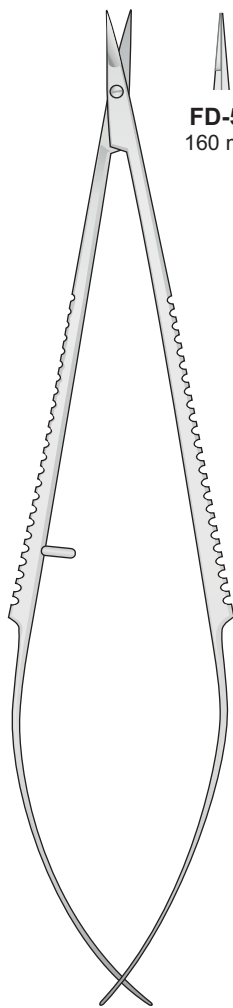
**FD-137**  
150 mm

**FD-138**  
150 mm

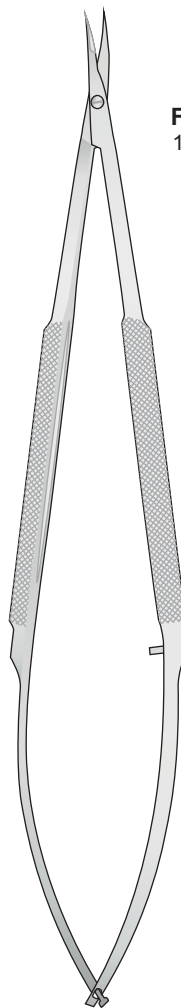


90°

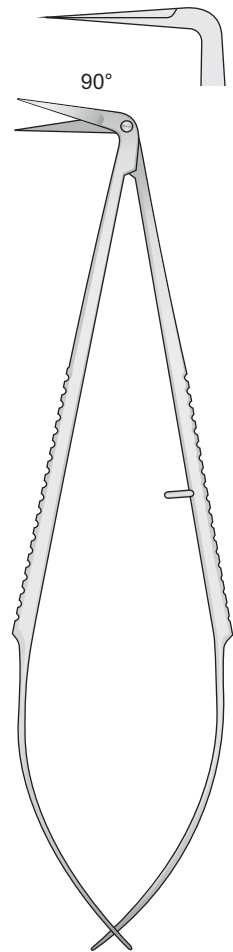
1/1



**FD-59/FD-60**  
160 mm



**FD-137/FD-138**  
150 mm



**FD-40**  
150 mm





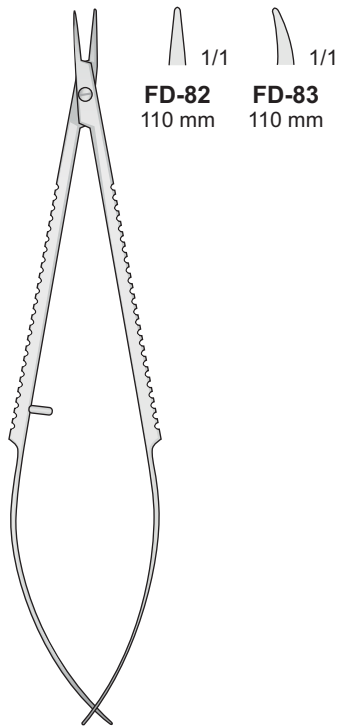
Micro port'aghi

Micro needle holders

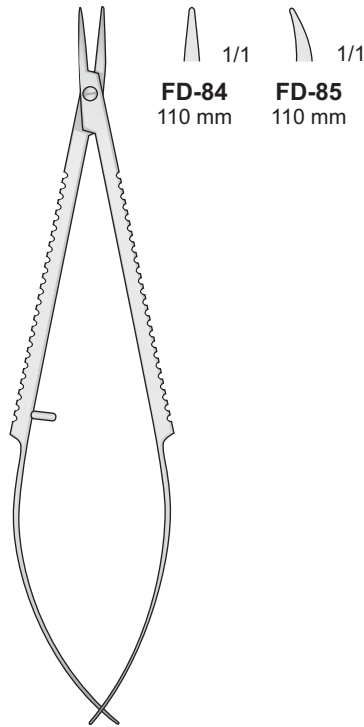
Micro Nadelhalter

Micro porte aiguilles

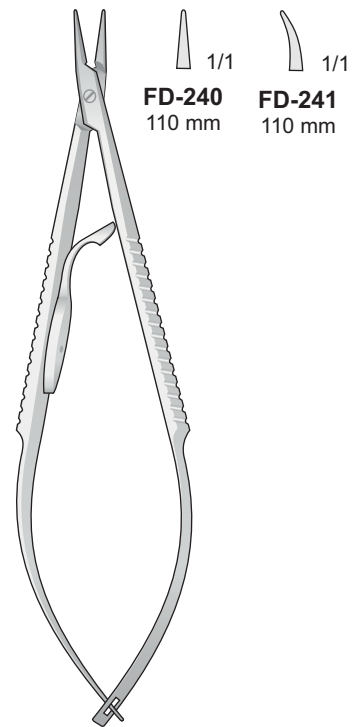
Micro portaagujas



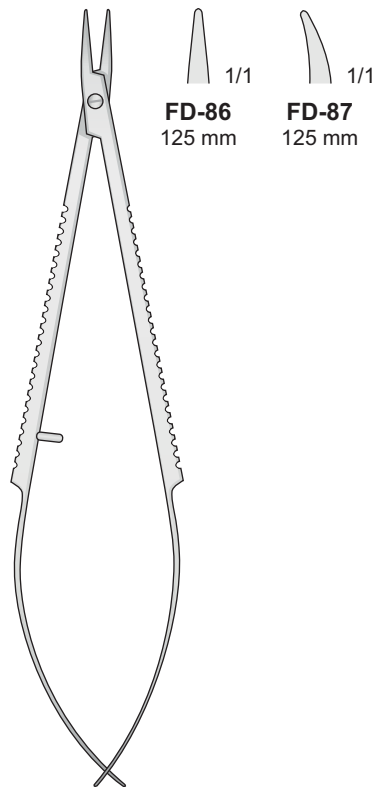
**FD-82/FD-83**  
110 mm



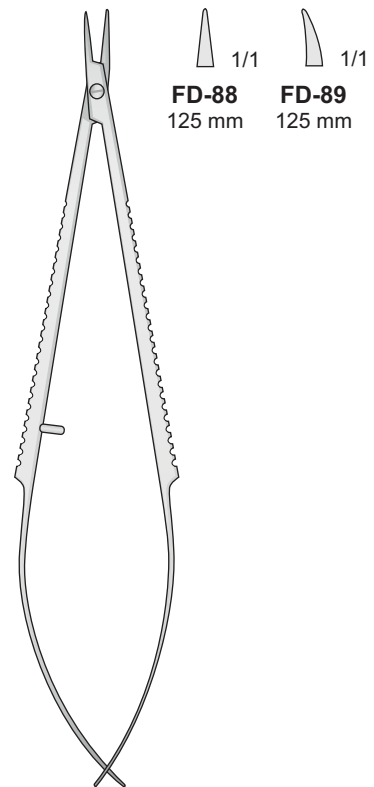
**FD-84/FD-85**  
110 mm



**FD-240/FD-241**  
110 mm



**FD-86/FD-87**  
125 mm



**FD-88/FD-89**  
125 mm



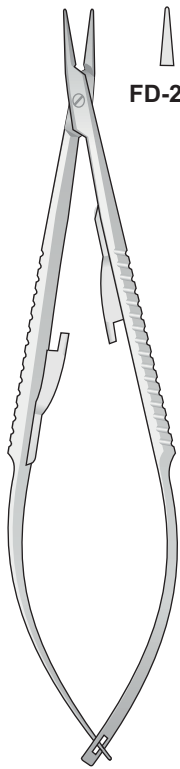
Micro port'aghi

Micro needle holders

Micro Nadelhalter

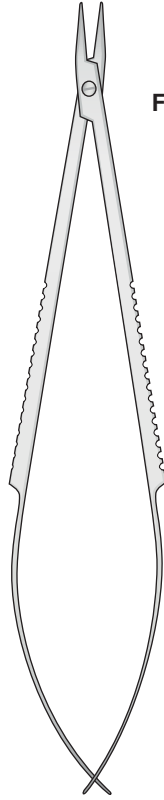
Micro porte aiguilles

Micro portaagujas



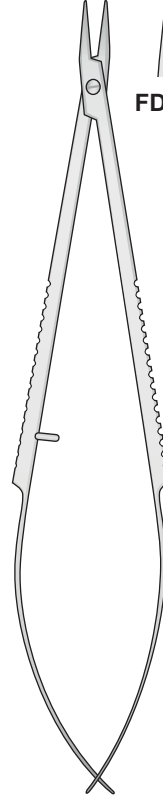
1/1  
1/1  
**FD-242** **FD-243**

**FD-242/FD-243**  
125 mm



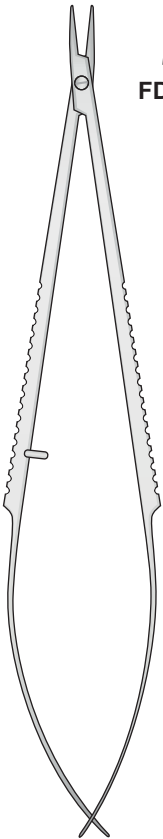
1/1  
1/1  
**FD-160** **FD-161**

**FD-160/FD-161**  
135 mm



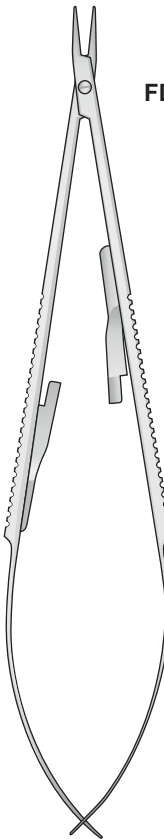
1/1  
1/1  
**FD-90** **FD-91**

**FD-90/FD-91**  
135 mm



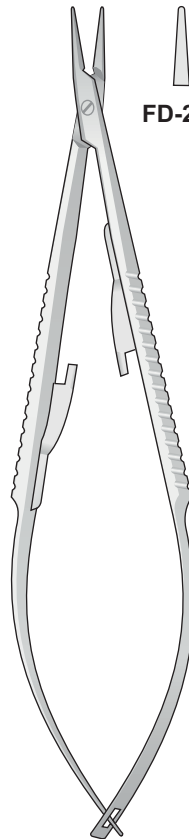
1/1  
1/1  
**FD-92** **FD-93**

**FD-92/FD-93**  
135 mm



1/1  
1/1  
**FD-94** **FD-95**

**FD-94/FD-95**  
135 mm



1/1  
1/1  
**FD-244** **FD-245**

**FD-244/FD-245**  
135 mm



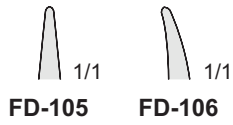
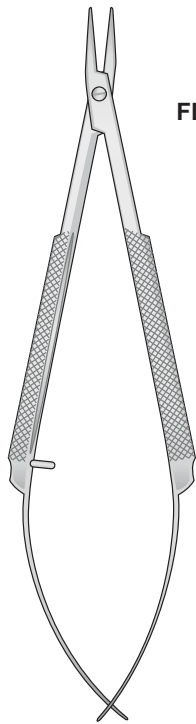
Micro port'aghi

Micro needle holders

Micro Nadelhalter

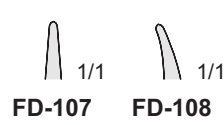
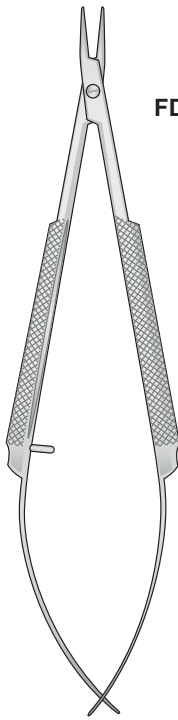
Micro porte aiguilles

Micro portaagujas



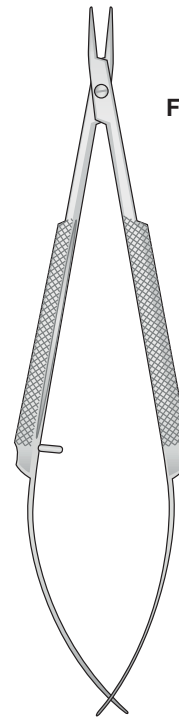
FD-105

FD-106



FD-107

FD-108

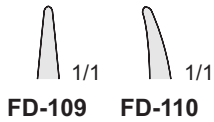
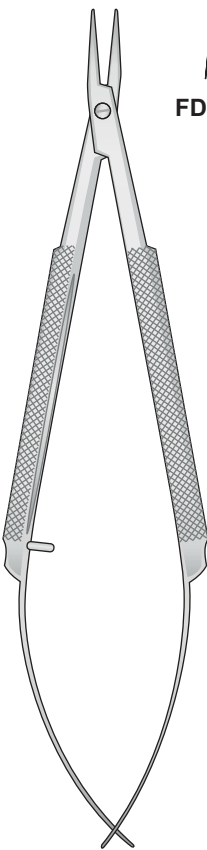


FD-162

FD-105/FD-106  
110 mm

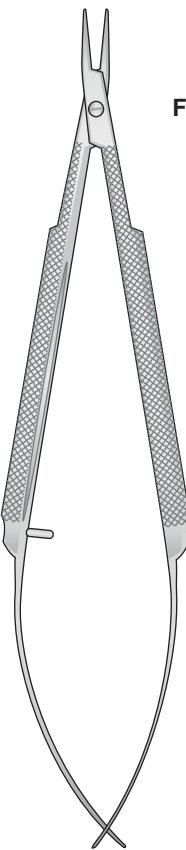
FD-107/FD-108  
110 mm

FD-162  
110 mm



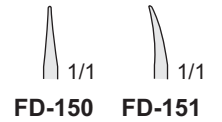
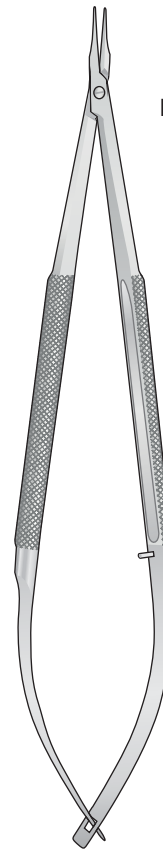
FD-109

FD-110



FD-111

FD-112



FD-150

FD-151

FD-109/FD-110  
125 mm

FD-111/FD-112  
125 mm

BARRAQUER  
FD-150/FD-151  
125 mm



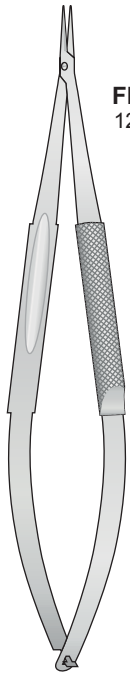
Micro port'aghi

Micro needle holders

Micro Nadelhalter

Micro porte aiguilles

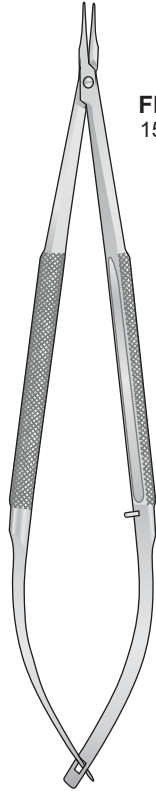
Micro portaagujas



 1/1  
**FD-154**  
125 mm

 1/1  
**FD-155**  
125 mm

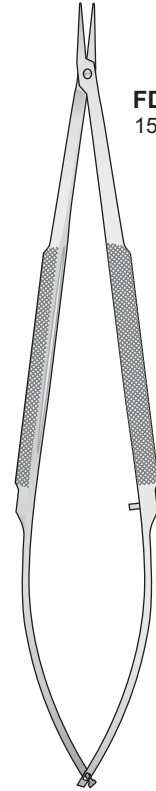
**BARRAQUER**  
**FD-154/FD-155**  
125 mm





 1/1  
**FD-152**  
150 mm

 1/1  
**FD-153**  
150 mm

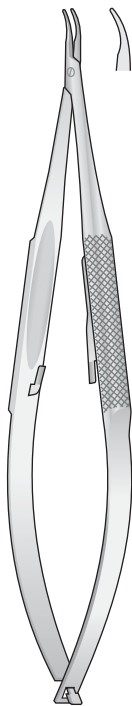
**BARRAQUER**  
**FD-152/FD-153**  
150 mm



 1/1  
**FD-156**  
150 mm

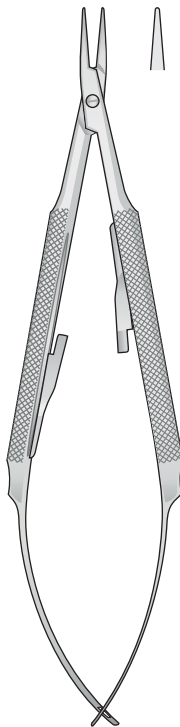
 1/1  
**FD-157**  
150 mm

**REILL**  
**FD-156/FD-157**  
150 mm



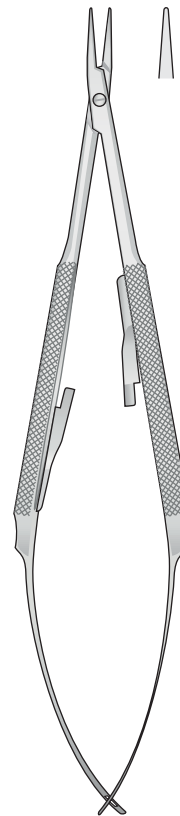
 1/1

**BARRAQUER**  
**FD-215**  
120 mm



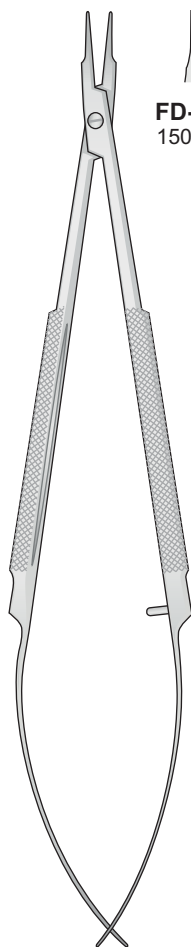
 1/1


**BARRAQUER**  
**FD-214**  
125 mm



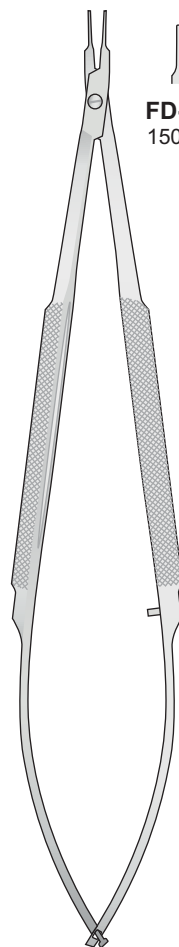
 1/1

**BARRAQUER**  
**FD-216**  
150 mm



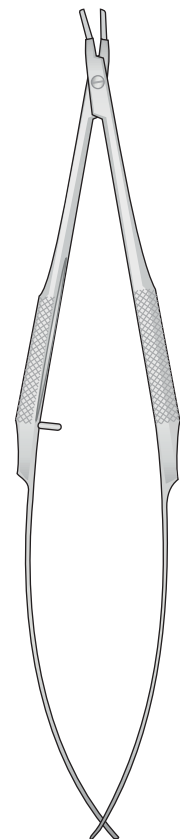
 1/1  
**FD-121**  
150 mm


 1/1  
**FD-122**  
150 mm



 1/1  
**FD-165**  
150 mm

 1/1  
**FD-166**  
150 mm



 1/1  
**FD-169**  
135 mm

**BARRAQUER**  
**FD-121/FD-122**  
150 mm

**BARRAQUER**  
**FD-165/FD-166**  
150 mm

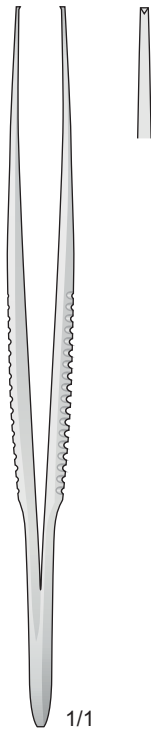
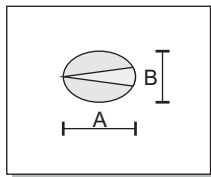
**BARRAQUER**  
**FD-169**  
135 mm



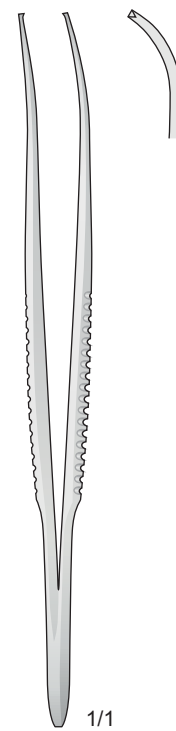
Micro pinzette  
 Micro forceps  
 Mikro Pinzetten  
 Micro pincers  
 Pinzas finos

1 x 2 Denti  
 1 x 2 Teeth  
 1 x 2 Zähne  
 1 x 2 Dents  
 1 x 2 Dientes

1 x 2 Denti  
 1 x 2 Teeth  
 1 x 2 Zähne  
 1 x 2 Dents  
 1 x 2 Dientes

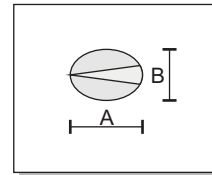


1/1



1/1

A	B		
0,4	0,25	<b>MF-34</b>	<b>MF-40</b>
0,5	0,35	<b>MF-35</b>	<b>MF-41</b>
0,7	0,55	<b>MF-36</b>	<b>MF-42</b>
1	0,8	<b>MF-37</b>	<b>MF-43</b>
1,2	0,9	<b>MF-38</b>	<b>MF-44</b>
		95 mm	95 mm

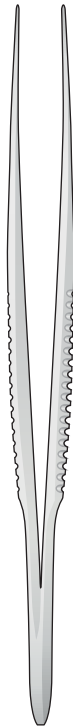


Micro pinzette  
 Micro forceps  
 Mikro Pinzetten  
 Micro pincers  
 Pinzas finos

1 x 2 Denti  
 1 x 2 Teeth  
 1 x 2 Zähne  
 1 x 2 Dents  
 1 x 2 Dientes

1 x 2 Denti  
 1 x 2 Teeth  
 1 x 2 Zähne  
 1 x 2 Dents  
 1 x 2 Dientes

Acuta  
 Sharp  
 Spitz  
 Pointu  
 Agudas

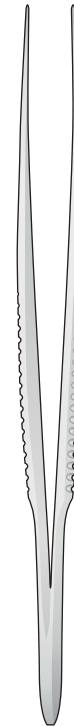
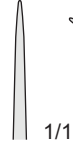


**MF-73**

1/1

**MF-74**

Smussa  
 Blunt  
 Stumpf  
 Mousse  
 Romas



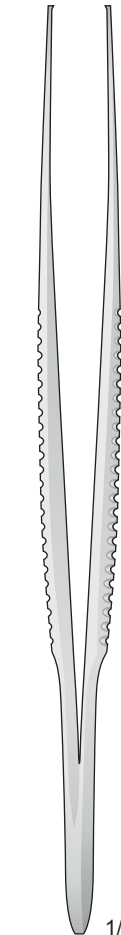
**MF-75**

1/1

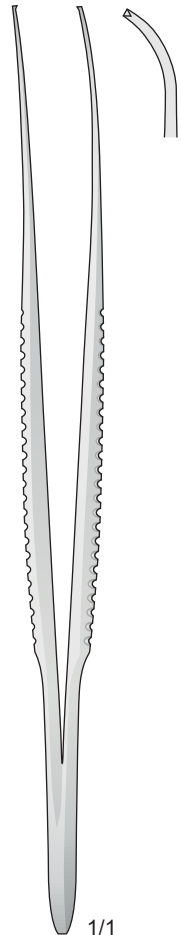
**MF-76**

**MF-73/MF-74**  
 95 mm

**MF-75/MF-76**  
 95 mm

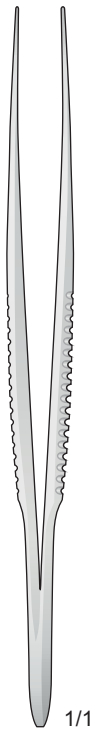
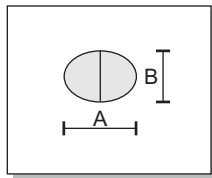


1/1

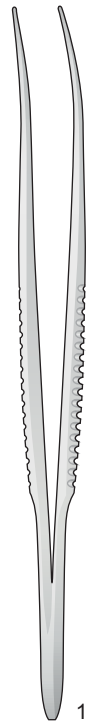


1/1

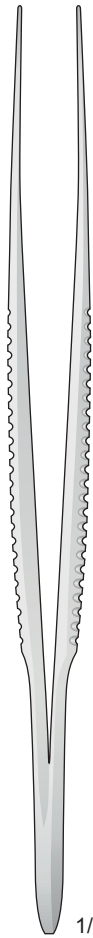
A	B		
0,4	0,25	<b>MF-46</b>	<b>MF-52</b>
0,5	0,35	<b>MF-47</b>	<b>MF-53</b>
0,7	0,55	<b>MF-48</b>	<b>MF-54</b>
1	0,8	<b>MF-49</b>	<b>MF-55</b>
1,2	0,9	<b>MF-50</b>	<b>MF-56</b>
		125 mm	125 mm



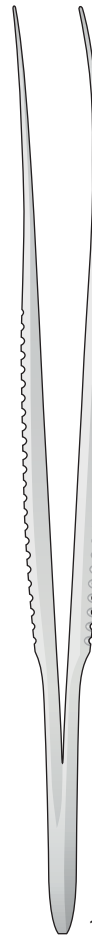
1/1



1/1



1/1

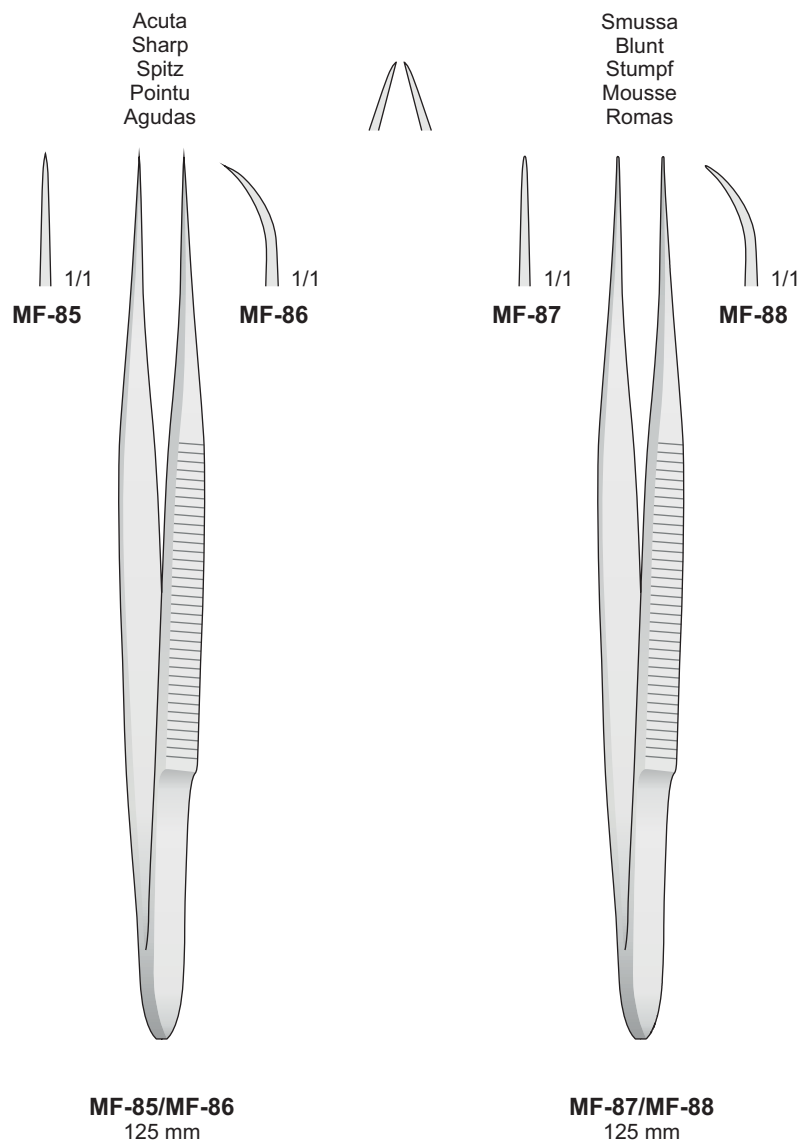


1/1



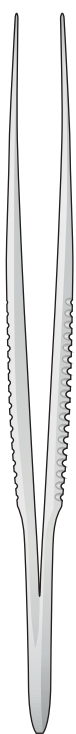
A	B				
0,5	0,4	<b>MF-24</b>	<b>MF-29</b>	<b>MF-19</b>	<b>MF-13</b>
0,6	0,5	<b>MF-25</b>	<b>MF-30</b>	<b>MF-20</b>	<b>MF-14</b>
0,9	0,7	<b>MF-26</b>	<b>MF-31</b>	<b>MF-21</b>	<b>MF-15</b>
1,3	1	<b>MF-27</b>	<b>MF-32</b>	<b>MF-22</b>	<b>MF-16</b>
1,6	1,3	<b>MF-28</b>	<b>MF-33</b>	<b>MF-23</b>	<b>MF-17</b>
		95 mm	95 mm	125 mm	125 mm







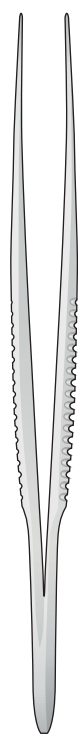
Acuta  
Sharp  
Spitz  
Pointu  
Agudas



MF-77 MF-78

MF-77/MF-78  
95 mm

Smussa  
Blunt  
Stumpf  
Mousse  
Romas



MF-79 MF-80

MF-79/MF-80  
95 mm

Acuta  
Sharp  
Spitz  
Pointu  
Agudas



MF-81/MF-82  
125 mm



MF-81

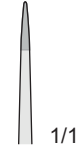


MF-82

Smussa  
Blunt  
Stumpf  
Mousse  
Romas



MF-83/MF-84  
125 mm



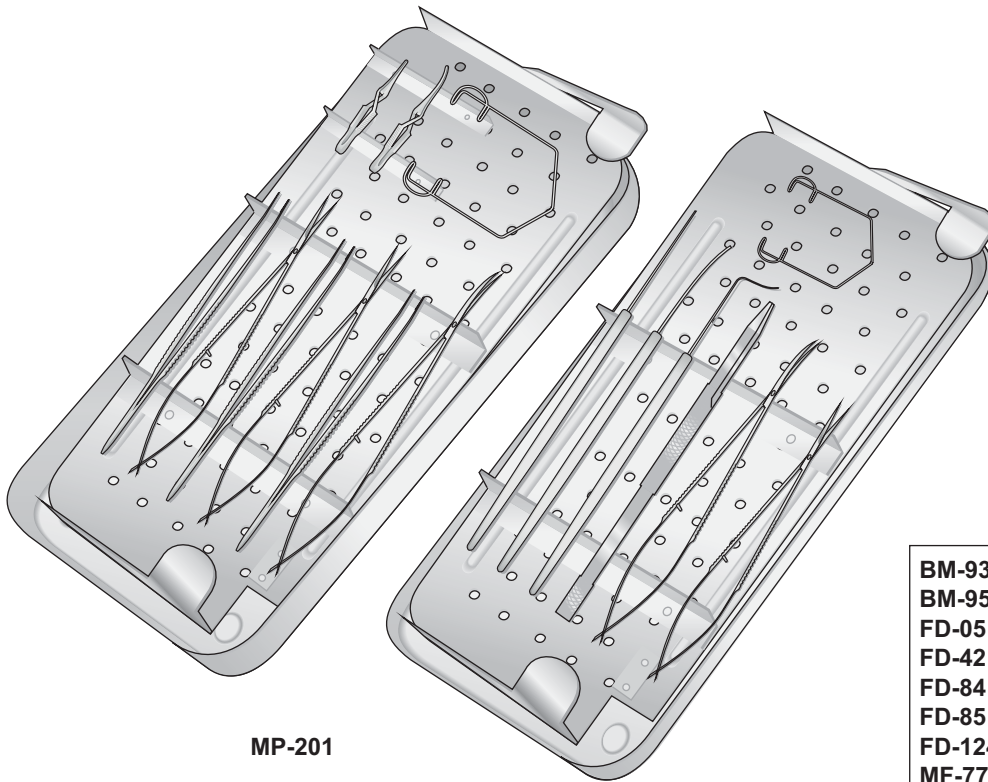
MF-83



MF-84



Set microchirurgia oftalmica  
Instrument sets  
Operationsbestecke



**MP-201**

**MP-201**  
Consisting

- BM-93** - Bulldog diritta cm. 4
- BM-95** - Bulldog diritta cm. 4,5
- FD-05** - Micro forbice curva cm. 11
- FD-42** - Micro forbice curva cm. 12
- FD-84** - Micro pinzetta diritta cm. 11
- FD-85** - Micro pinzetta curva cm. 11
- FD-124** - Micro pinzetta 1x2 denti cm. 11
- MF-77** - Micro pinzetta diritta cm. 9,5
- MF-79** - Micro pinzetta diritta cm. 9,5
- NK-12** - Porta lame per micro cm. 12
- NK-18** - Micro bisturi Graefe cm. 13
- NK-23** - Micro divar. Castrovejo cm. 13
- NK-28** - Micro spatole Wecker cm. 13
- NK-60** - Micro pinzetta Colibri cm. 8
- NK-80** - Blefarostato Barraquer mm. 27x5



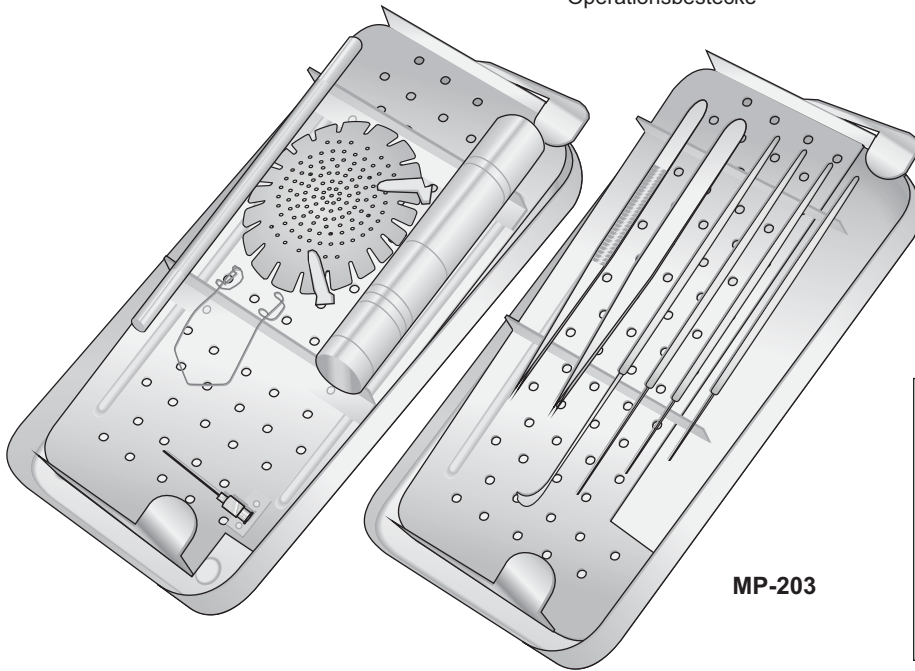
**MP-210**

**MP-210**  
Consisting

- BT-16** - Micro divar. Gillies # 2
- DB-21** - Curette Day cm. 16
- FD-54** - Micro forbice curva cm. 16
- FD-135** - Micro forbice diritta cm. 16
- FD-158** - Micro port'aghi dir. cm. 15
- FD-159** - Micro port'aghi curvo cm. 15
- MF-58** - Micro pinzetta 1x2 denti cm. 15
- MF-64** - Micro pinzetta 1x2 denti cm. 15
- MF-93** - Micro pinzetta diritta cm. 15
- MF-94** - Micro pinzetta curva cm. 15



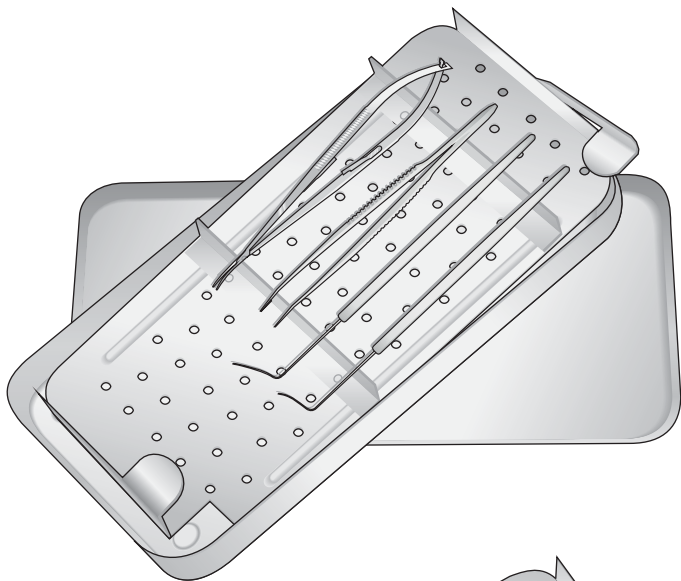
Set microchirurgia oftalmica  
Instrument sets  
Operationsbestecke



MP-203

**MP-203**  
Consisting

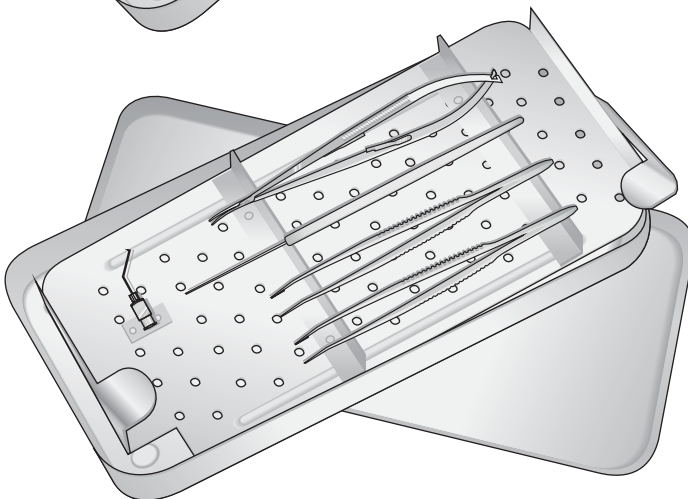
- BD-204** - Micro pinzetta cm. 12
- BT-70** - Div. Desmarres mm. 10
- MF-97** - Micro pinzetta cm. 8,5
- NK-09** - Bisturi Ellis cm. 12
- NK-48** - Spatola Kimura cm. 15
- NK-79** - Blefarostato Barraquer mm.27
- NK-97** - Dilatatore Wilder #1
- NK-398** - Pseudo sfera piombo
- OL-20** - Occlusore alluminio mm. 75



MP-204

**MP-204**  
Consisting

- BD-235** - Micro pinzetta cm. 12
- FD-132** - Micro pinzetta cm. 11
- NK-74** - Micro divaricatore mm. 0,2
- NK-75** - Uncino angolato cm. 13



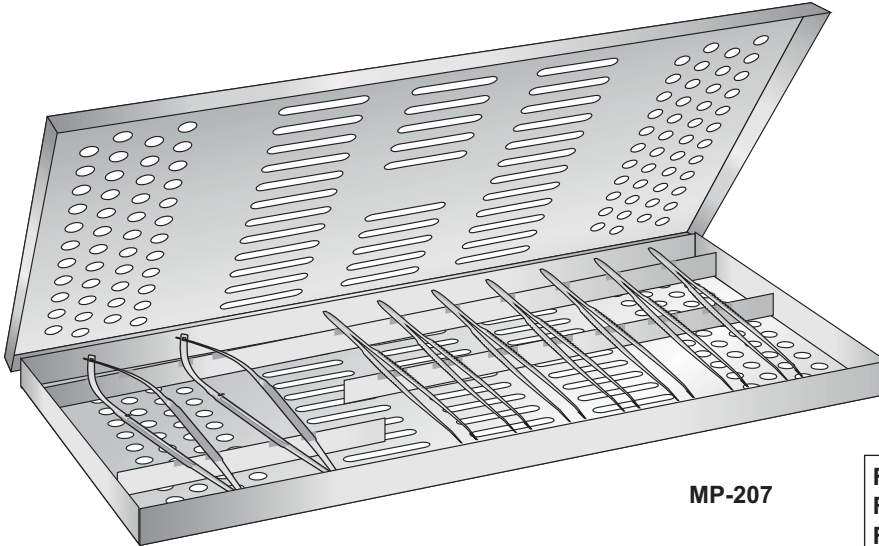
MP-206

**MP-206**  
Consisting

- FD-118** - Micro pinzetta 1x2 denti cm. 9,5
- FD-123** - Micro pinzetta McPerson cm. 9,5
- FD-132** - Micro pinzetta cristallino cm. 11
- NK-93** - Micro spatola mm. 0,2
- OL-53** - Ago lacrimale curvo mm. 35



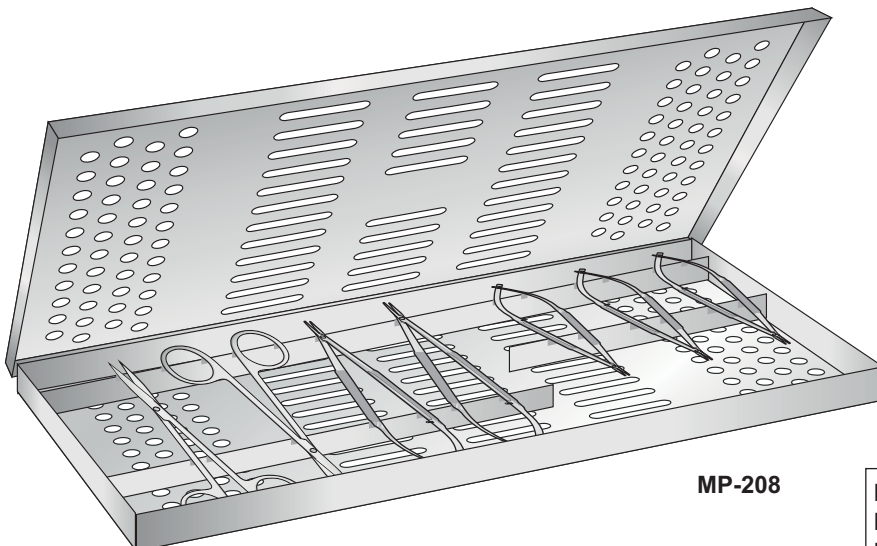
Set microchirurgia oftalmica  
Instrument sets  
Operationsbestecke



**MP-207**

**MP-207**  
Consisting

- FD-118** - Micro pinzetta 1x2 denti cm. 9,5
- FD-123** - Micro pinzetta McPherson cm. 9,5
- FD-132** - Micro pinzetta cristallino cm. 11
- FD-136** - Micro pinzetta angolata cm. 11
- MF-34** - Micro pinzetta 1x2 denti cm. 9,5
- MF-40** - Micro pinzetta 1x2 denti cm. 9,5
- MF-79** - Micro pinzetta diritta cm. 9,5
- MF-80** - Micro pinzetta curva cm. 9,5
- NK-69** - Micro pinzetta Colibri cm. 9,5



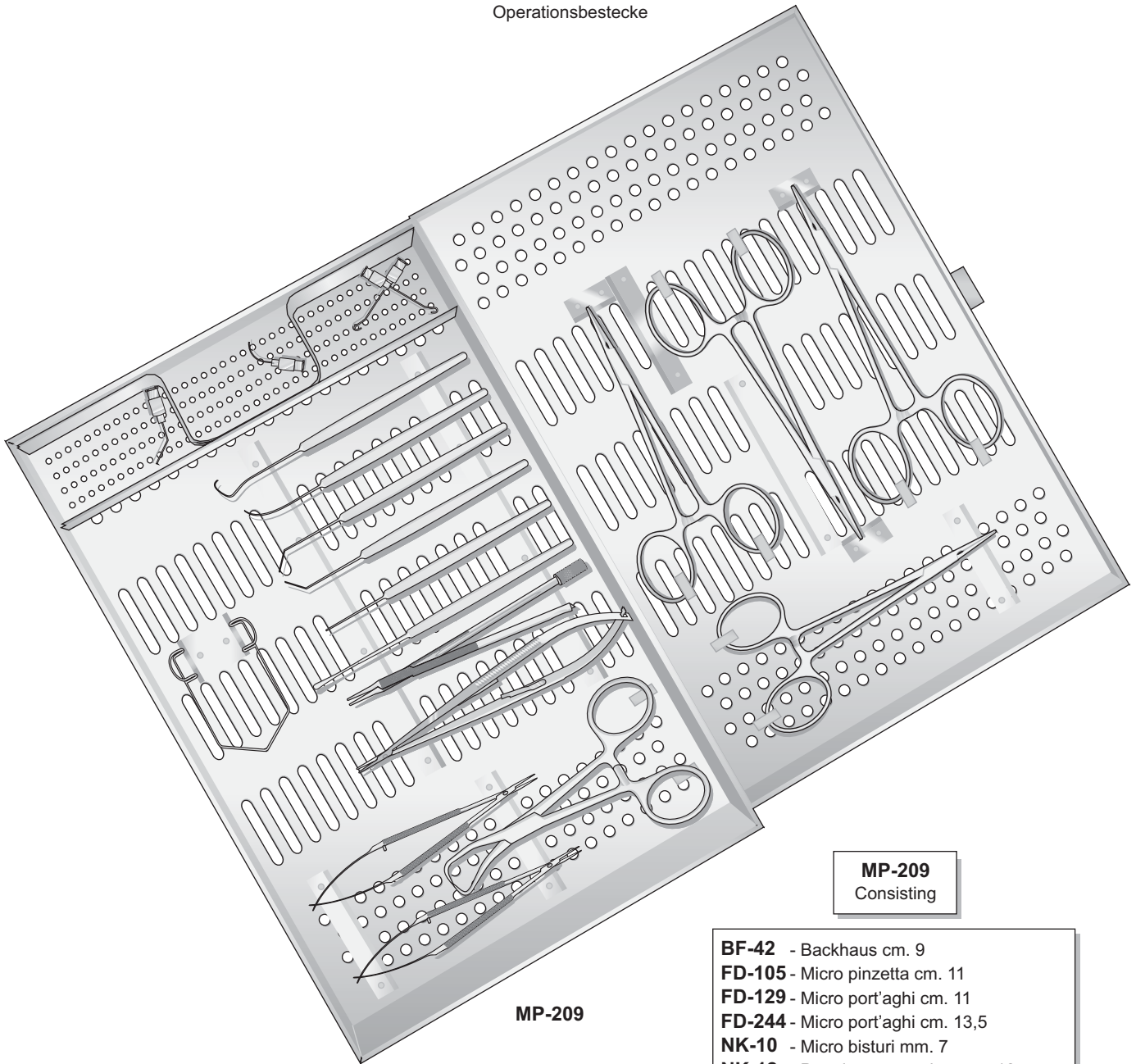
**MP-208**

**MP-208**  
Consisting

- FD-69** - Micro forbice Troutmann dx. cm. 11
- FD-70** - Micro forbice Troutmann sx. cm. 11
- FD-79** - Micro forbice Vannas cm. 8,5
- FD-80** - Micro forbice Vannas cm. 8,5
- FD-81** - Micro forbice Vannas cm. 8,5
- FG- 1** - Forbice Iris diritta cm. 11
- FG- 2** - Forbice Iris curva cm. 11



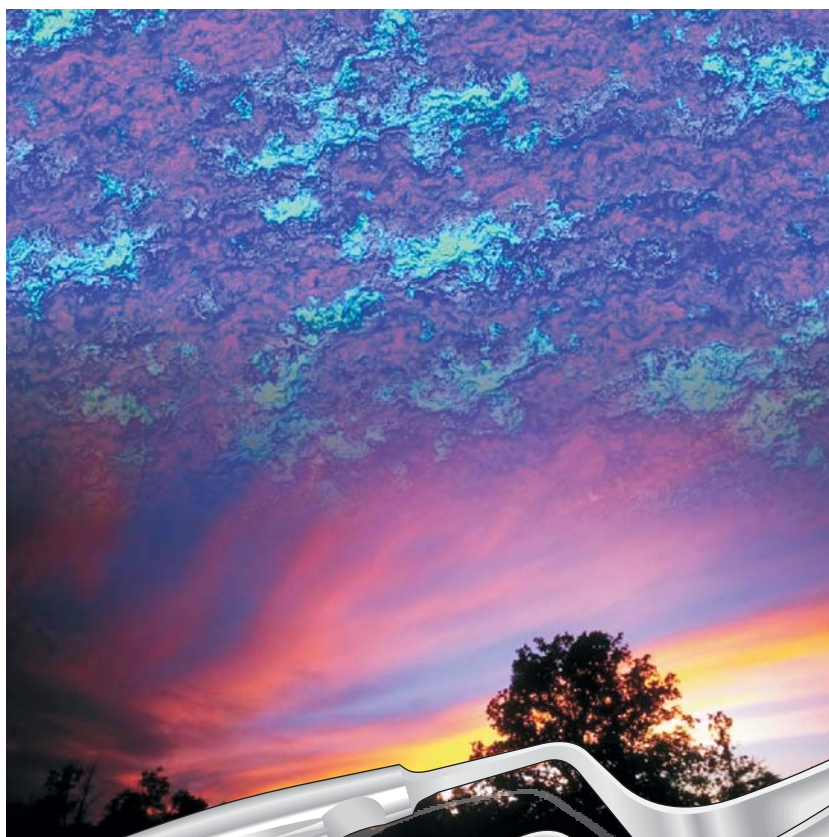
Set microchirurgia oftalmica  
Instrument sets  
Operationsbestecke



**MP-209**

**MP-209**  
Consisting

- BF-42** - Backhaus cm. 9
- FD-105** - Micro pinzetta cm. 11
- FD-129** - Micro port'aghi cm. 11
- FD-244** - Micro port'aghi cm. 13,5
- NK-10** - Micro bisturi mm. 7
- NK-12** - Portalame per micro cm. 12
- NK-45** - Micro divaricatore Snellen cm. 12
- NK-59** - Uncino Arruga cm. 14
- NK-84** - Blefarostato Barraquer mm. 42x12
- NK-93** - Micro spatola mm. 0,2
- NK-110** - Micro spatola mm. 0,6
- NK-111** - Micro spatola mm. 1
- OL-51** - Ago lacrimale curvo mm. 30
- OL-52** - Ago lacrimale 15° Sx.
- OL-53** - Ago lacrimale 15° Dx.
- OL-50** - Ago lacrimale curvo mm. 35
- P -91** - Halstead diritta cm. 12,5
- P -111** - Pinza Anat. Diritta cm. 14



**16**

Urologia, Ginecologia  
Urology, Gynecology  
Urologie, Gynäkologie  
Urologie, Gynécologie  
Urologia, Ginecologia







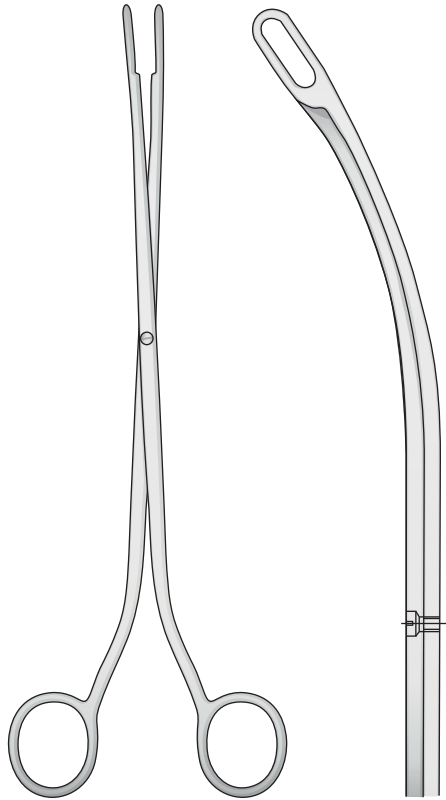
Pinze per  
calcoli renali

Kidney stone  
forceps

Nierensteinzangen

Pinces pour  
les calculs renaux

Pinzas para  
cálculos renales



DESJARDINS  
EB-11/EB-14  
225 mm

Fig. 1



EB-11

Fig. 2



EB-12

Fig. 3

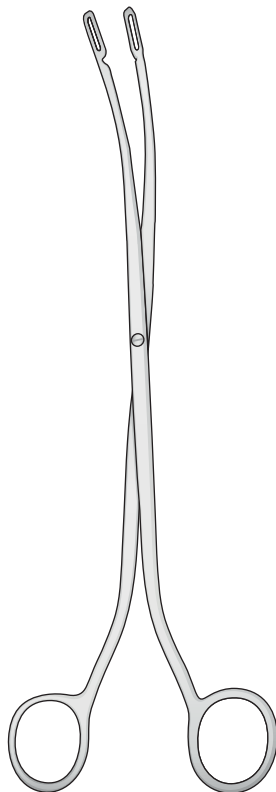


EB-13

Fig. 4

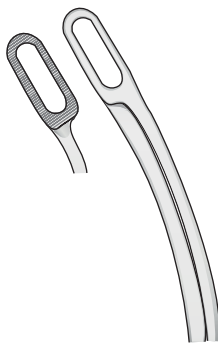


EB-14



RANDALL  
EB-36/EB-39  
225 mm

Fig. 1



EB-36

Fig. 2



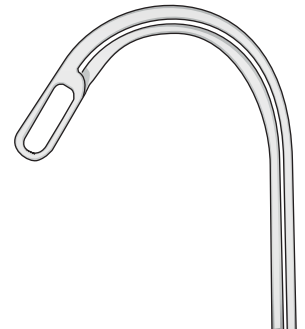
EB-37

Fig. 3



EB-38

Fig. 4



EB-39



Cateteri  
Sonde metalliche

Catheters metal

Katheterspanner  
Metallkatheter

Sondes métalliques

Catéteres  
Sondas metálicas

Strumenti per tendere ed introdurre i cateteri  
Catheter introducing instruments  
Katheter-Einführungsinstrumente  
Mandrin pour introduire les sondes  
Instrumentos para introducir catéteres

Ø 1,2 mm

Ø 3 mm

Ø 3 mm

Ø 2,7 mm

Per uomini  
For men  
Für Männer  
Pour hommes  
Para hombres

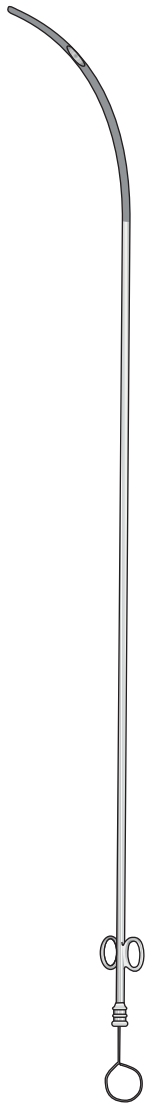
Charr.

EA-60	8
EA-62	10
EA-63	12
EA-64	14
EA-65	16
EA-66	18
EA-67	20

Per donne  
For woman  
Für Frauer  
Pour femmes  
Para mujeres

Charr.

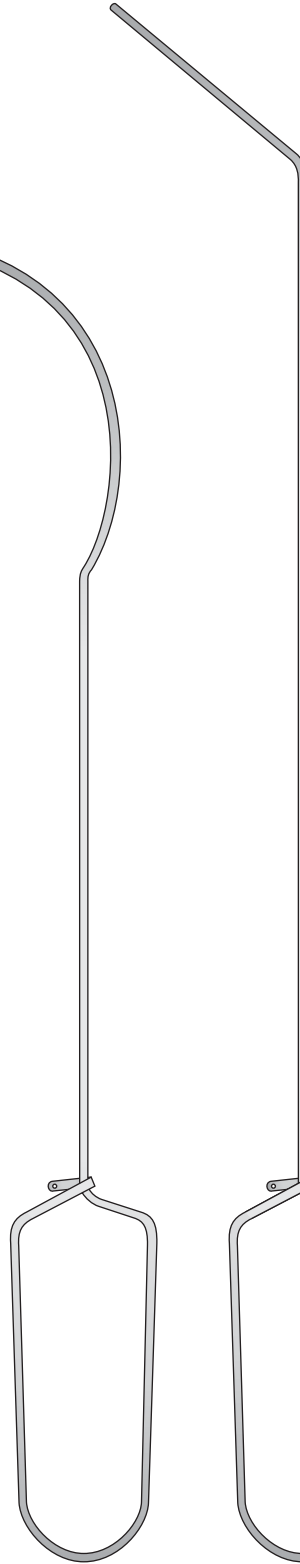
EA-70	6
EA-72	8
EA-74	10
EA-76	12
EA-77	14
EA-78	16
EA-79	18



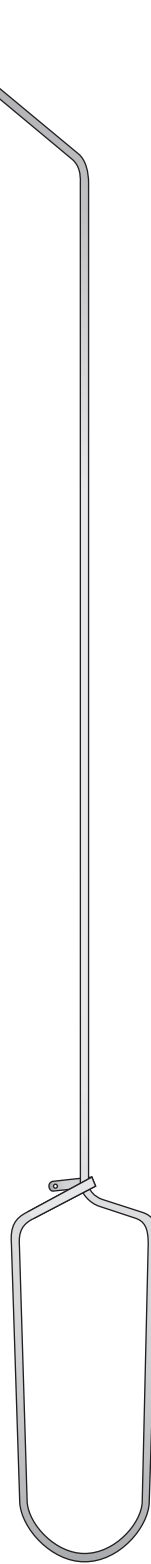
EA-60/EA-67  
290 mm



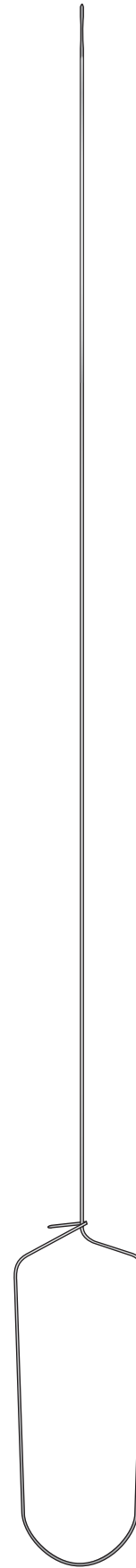
EA-70/EA-79  
160 mm



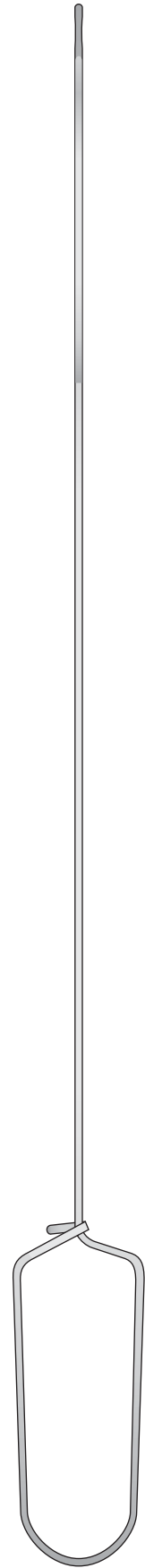
GUYON  
EA-90  
365 mm



BENIQUE  
EA-91  
410 mm



EA-93  
460 mm



EA-92  
460 mm



Dilatatori per  
vie biliari

Gall duct  
dilators

Gallengang-  
Dilatatoren

Dilatateurs pour  
les voies biliaires

Dilatadores para  
conductos biliares

**FB-321** - 190 mm - Ø 3 mm  
**FB-322** - 190 mm - Ø 4 mm  
**FB-323** - 190 mm - Ø 5 mm  
**FB-324** - 190 mm - Ø 6 mm  
**FB-325** - 190 mm - Ø 7 mm  
**FB-326** - 190 mm - Ø 8 mm  
**FB-327** - 190 mm - Ø 9 mm  
**FB-328** - 190 mm - Ø 10 mm  
**FB-329** - 190 mm - Ø 11 mm

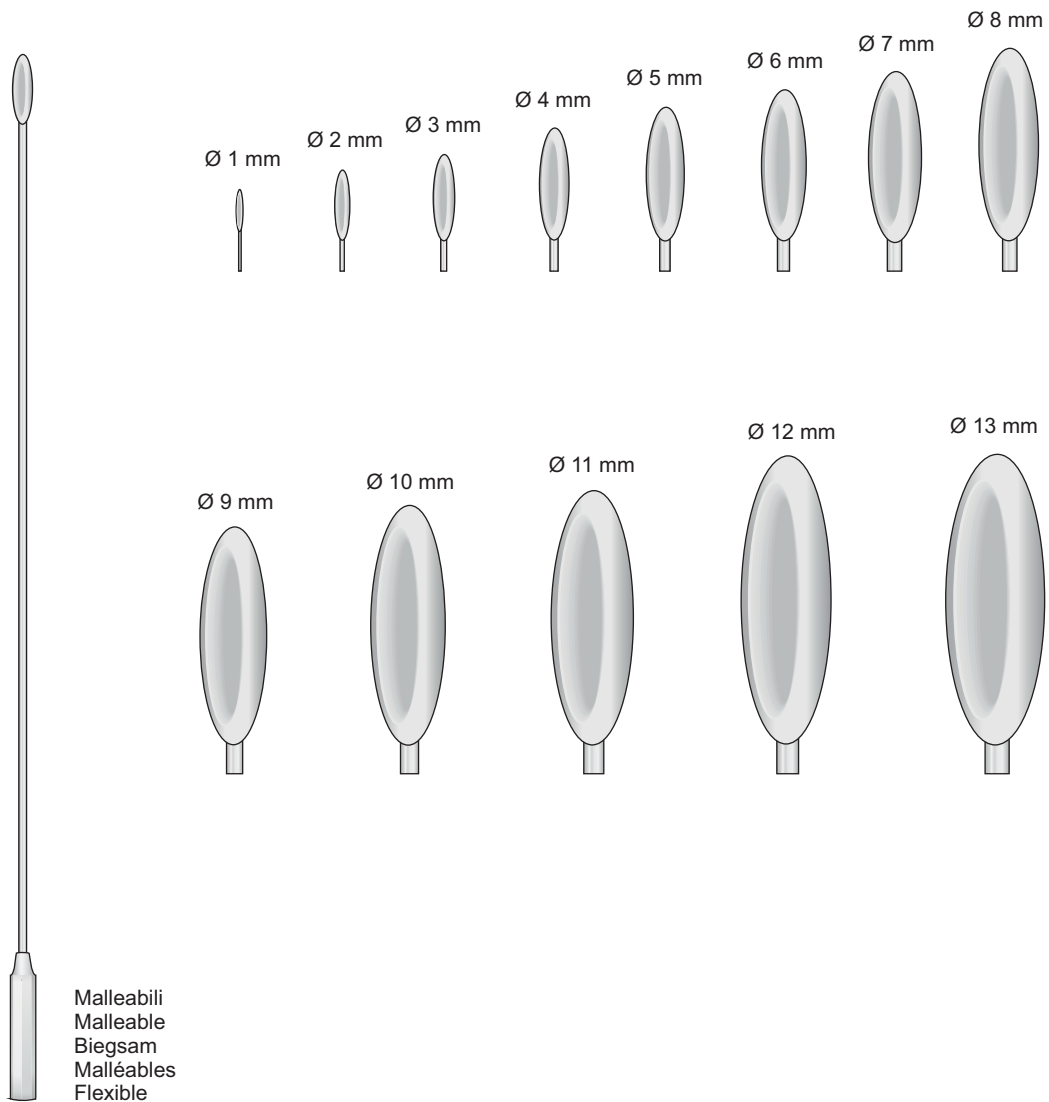
**FB-331** - 300 mm - Ø 1 mm  
**FB-332** - 300 mm - Ø 2 mm  
**FB-333** - 300 mm - Ø 3 mm  
**FB-334** - 300 mm - Ø 4 mm  
**FB-335** - 300 mm - Ø 5 mm  
**FB-336** - 300 mm - Ø 6 mm  
**FB-337** - 300 mm - Ø 7 mm  
**FB-338** - 300 mm - Ø 8 mm  
**FB-339** - 300 mm - Ø 9 mm  
**FB-340** - 300 mm - Ø 10 mm  
**FB-341** - 300 mm - Ø 11 mm  
**FB-342** - 300 mm - Ø 12 mm  
**FB-343** - 300 mm - Ø 13 mm

**FB-320**

Set di 9 pezzi con custodia  
 Set of 9 pieces in canvas pocket  
 Satz à 9 Stück in Leinentuchtasche  
 Jeu de 9 pièces dans une poche en toile  
 Juego de 9 unidades en bolsa de tela

**FB-330**

Set di 13 pezzi  
 Set of 13 pieces  
 Satz à 13 Stück  
 Jeu de 13 pièces  
 Juego de 13 unidades



Malleabili  
 Malleable  
 Biegsam  
 Malléables  
 Flexible

BAKES  
**FB-321/FB-343**



Dilatatori per  
vie biliari

Gall duct  
dilators

Gallengang-  
Dilatatoren

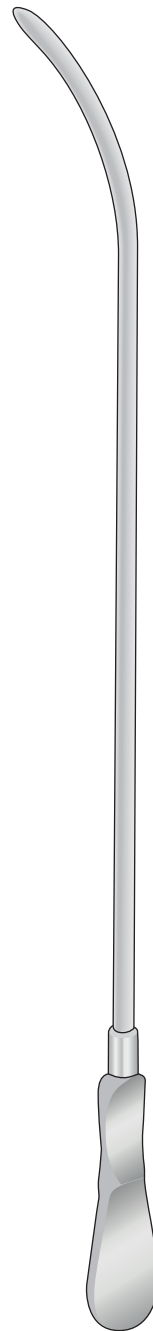
Dilatateurs pour  
les voies biliaires

Dilatadores para  
conductos biliares



DITTEL  
EB-251/EB-267  
220 mm

	Charr.
EB-251	8
EB-252	9
EB-253	10
EB-254	11
EB-255	12
EB-256	14
EB-257	16
EB-258	18
EB-259	20
EB-260	22
EB-261	24
EB-262	25
EB-263	26
EB-264	27
EB-265	28
EB-266	29
EB-267	30



DITTEL  
EB-201/EB-223  
345 mm

	Charr.
EB-201	8
EB-202	9
EB-203	10
EB-204	11
EB-205	12
EB-206	13
EB-207	14
EB-208	15
EB-209	16
EB-210	17
EB-211	18
EB-212	19
EB-213	20
EB-214	21
EB-215	22
EB-216	23
EB-217	24
EB-218	25
EB-219	26
EB-220	27
EB-221	28
EB-222	29
EB-223	30



Dilatatori per  
vie biliari

Gall duct  
dilators

Gallengang-  
Dilatatoren

Dilatateurs pour  
les voies biliaires

Dilatadores para  
conductos biliares

**EB-49** - Ø 10 mm  1/1

**EB-48** - Ø 9 mm  1/1

**EB-47** - Ø 8 mm  1/1

**EB-46** - Ø 7 mm  1/1

**EB-45** - Ø 6 mm  1/1

**EB-44** - Ø 5 mm  1/1

**EB-43** - Ø 4 mm  1/1

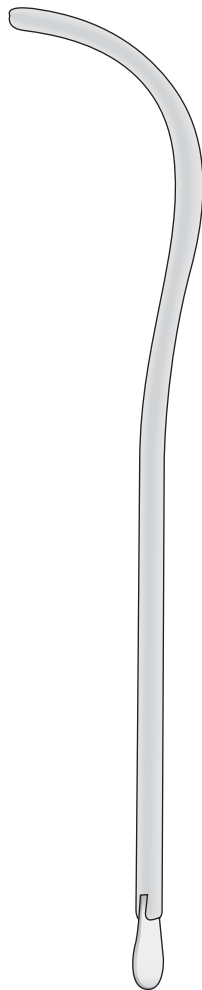
**EB-42** - Ø 3 mm  1/1

**EB-42/EB-49**  
190 mm

**EB-250**

Set completo con 19 pezzi  
 Set complete with 19 pieces  
 Kompletset mit 19 Stück  
 Set complet avec 19 pièces  
 Set completo con 19 piezas

da Ch.12 a Ch.30



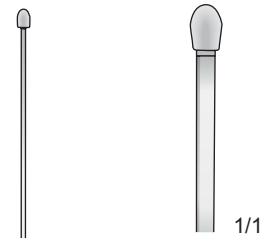
GUYON  
**EB-231/EB-249**  
 255 mm

Ben. Charr.

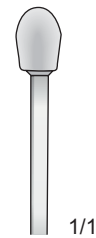
<b>EB-231</b>	24	12
<b>EB-232</b>	26	13
<b>EB-233</b>	28	14
<b>EB-234</b>	30	15
<b>EB-235</b>	32	16
<b>EB-236</b>	34	17
<b>EB-237</b>	36	18
<b>EB-238</b>	38	19
<b>EB-239</b>	40	20
<b>EB-240</b>	42	21
<b>EB-241</b>	44	22
<b>EB-242</b>	46	23
<b>EB-243</b>	48	24
<b>EB-244</b>	50	25
<b>EB-245</b>	52	26
<b>EB-246</b>	54	27
<b>EB-247</b>	56	28
<b>EB-248</b>	58	29
<b>EB-249</b>	60	30

Sonde per dotto biliare, Elastiche  
 Gall Stone Probes, Elastic  
 Gallensteinsonden, Federnd  
 Explorateurs pour calculs biliaires, Élastiques  
 Exploradores para cálculos biliares, Elásticos

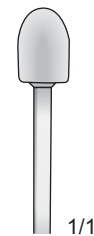
Ø 4,3 mm

**EB-18**

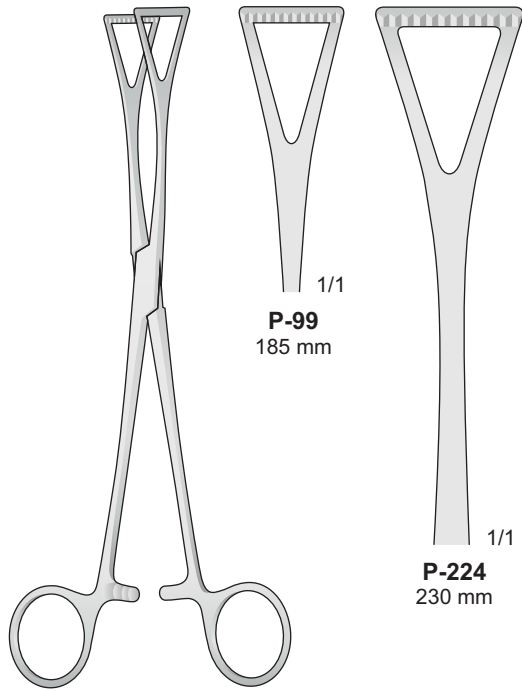
Ø 6,0 mm

**EB-19**

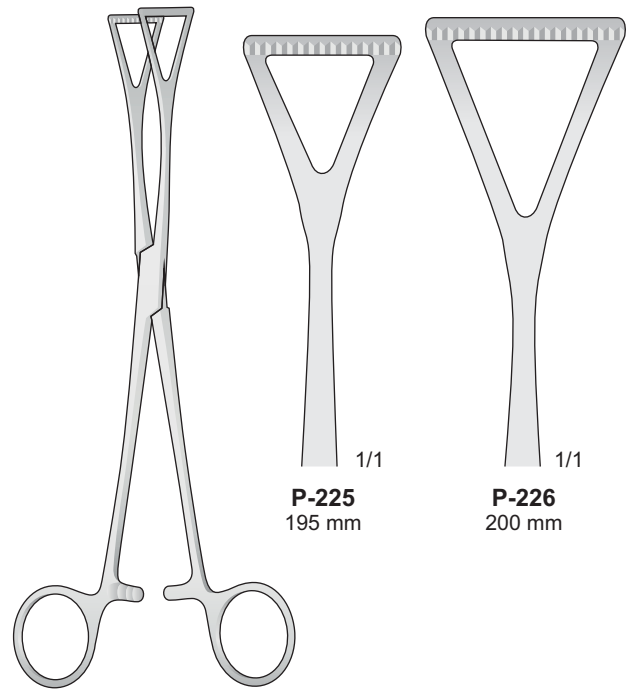
Ø 7,0 mm

**EB-20**

DESJARDINS  
**EB-18/EB-20**  
 280 mm

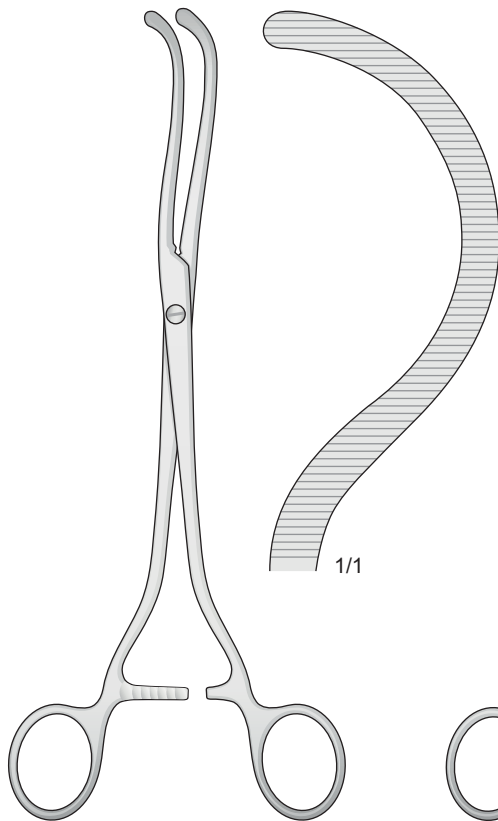


DUVAL  
P-99/P-224

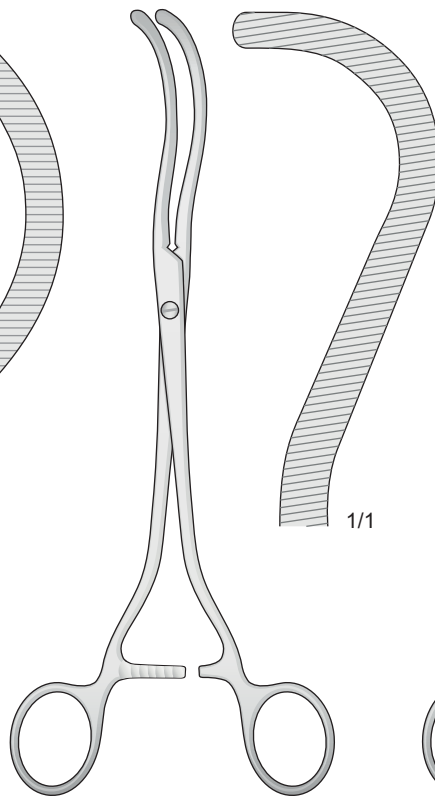


DUVAL-COLLIN  
P-225/P-226

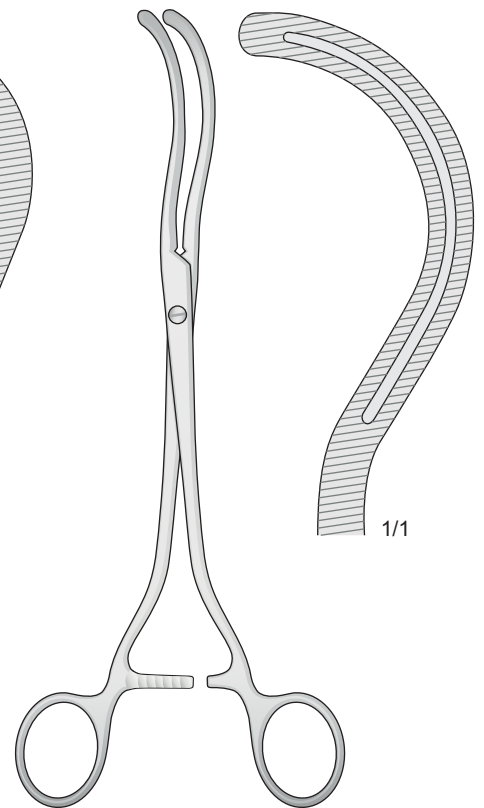
Pinze per peduncoli renali - Kidney pedicle clamp forceps - Nierenstielklemmen  
Pincas-clamps pour p dicules r naux - Pinzas-clamps para ped nculos renales



BRAUN  
EB-30  
245 mm



GUYON  
EB-31  
235 mm



STILLE  
EB-32  
240 mm



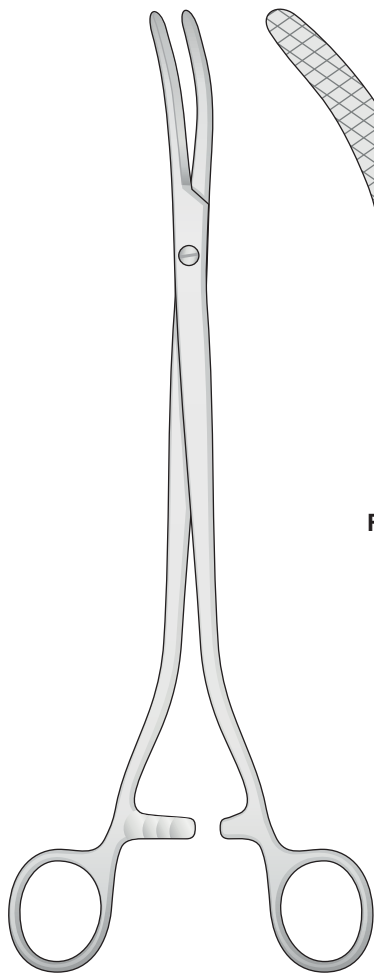
Pinze per  
peduncoli renali

Kidney pedicle  
forceps

Nierenklemmen

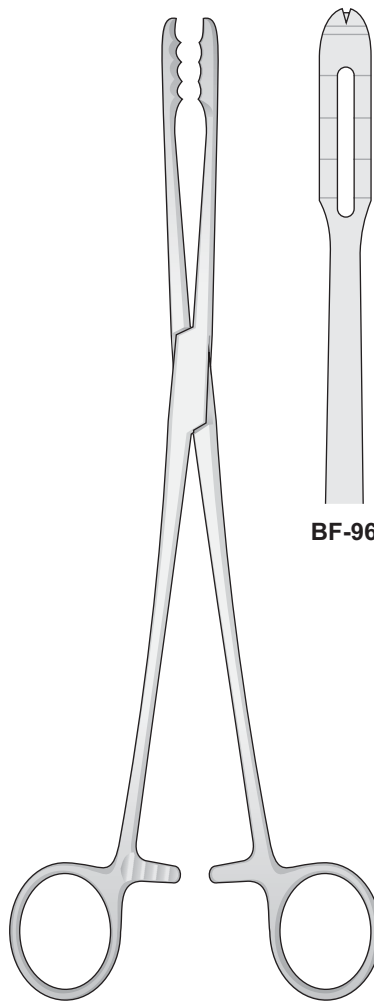
Pinces-clamps pour  
pédicules rénaux

Pinzas para  
pedúnculos renales



1/1  
**FB-41**

WERTHEIM  
**FB-41**  
260 mm



1/1  
**BF-96**

1/1  
**BF-97**

**BF-96/BF-97**  
265 mm





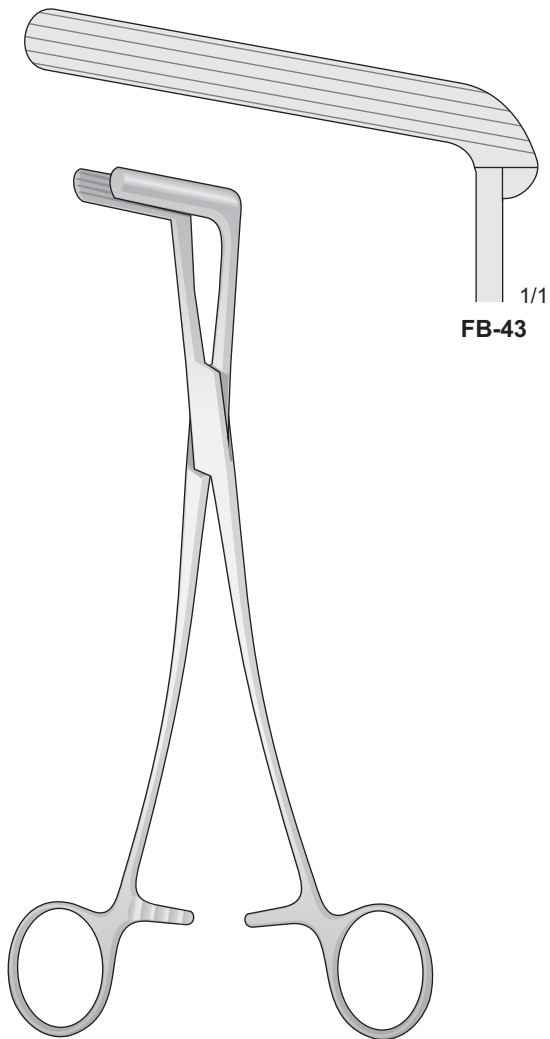
Pinze per  
peduncoli renali

Kidney pedicle  
forceps

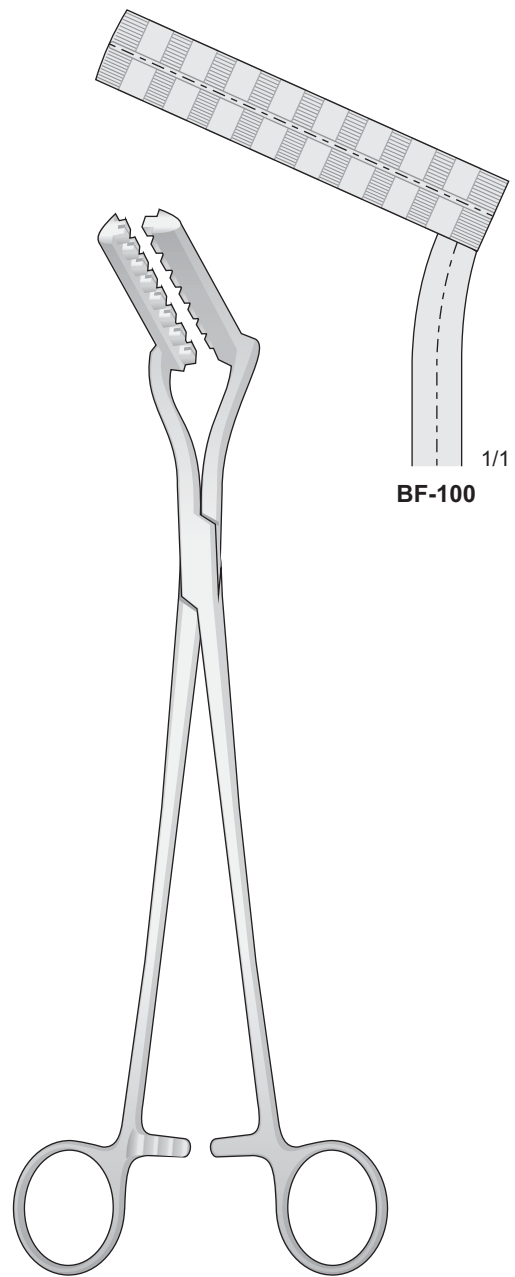
Nierenklemmen

Pinces-clamps pour  
pédicules rénaux

Pinzas para  
pedúnculos renales



WERTHEIM  
FB-43  
235 mm



BF-100  
280 mm



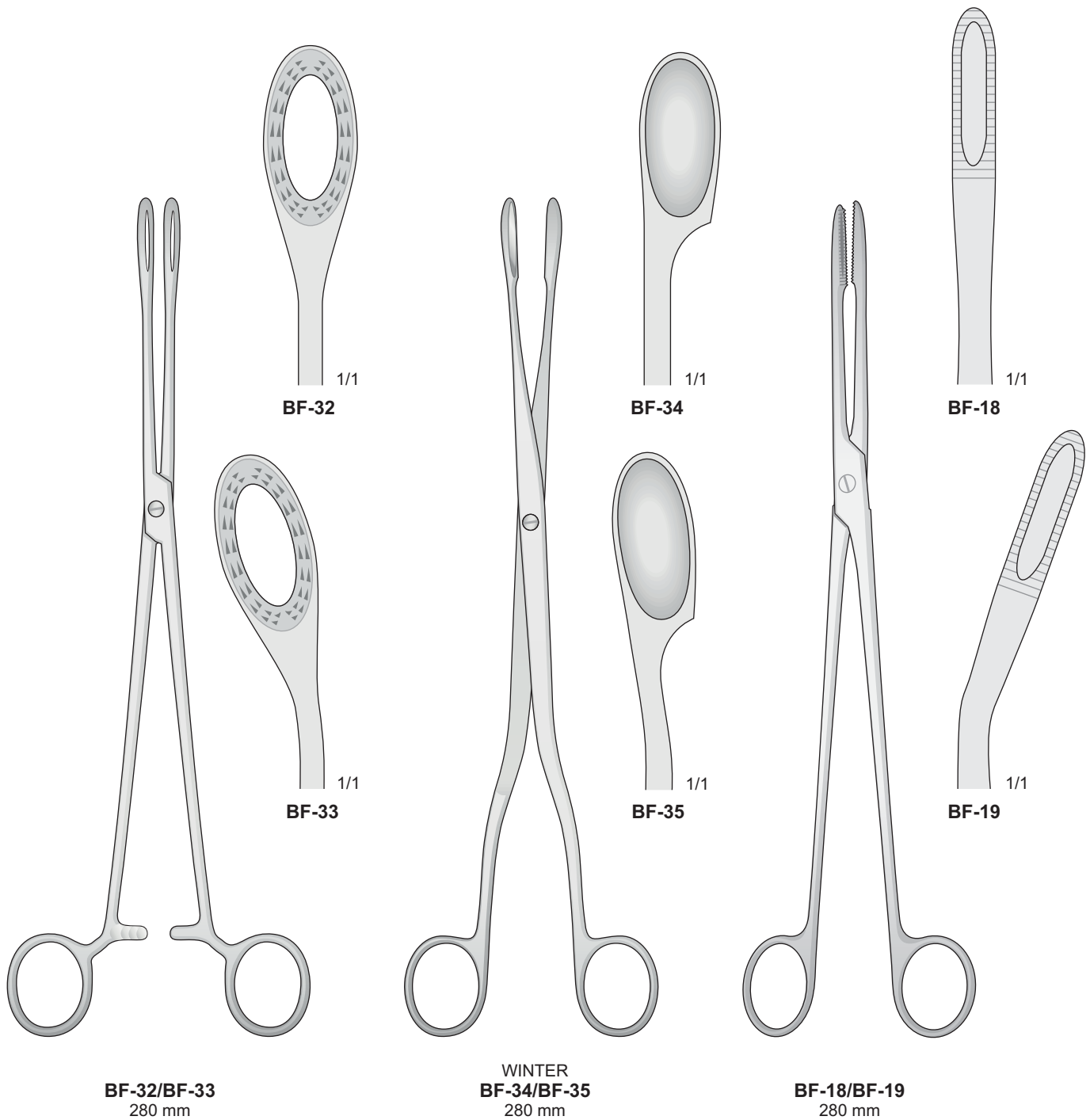
Pinze da placenta  
e aborto

Placenta  
and ovum forceps

Placentar  
und Abortuszangen

Pinces à faux  
germes

Pinzas para  
aborte





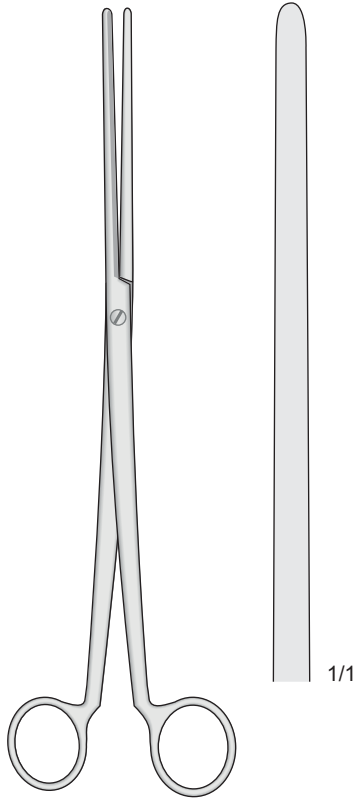
Pinze per tamponi  
Pinze emostatiche

Cotton Swab forceps  
Artery forceps

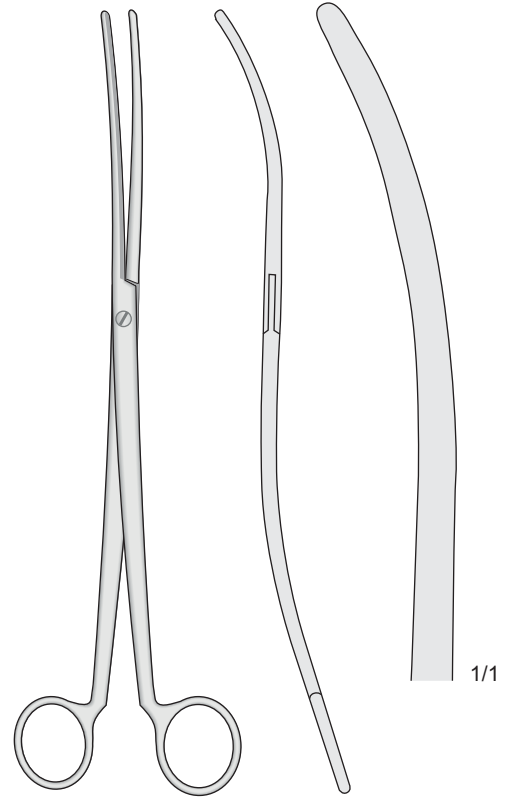
Tupferzangen  
Arterienklemmen

Pinces à tampons  
Pinces hémostatiques

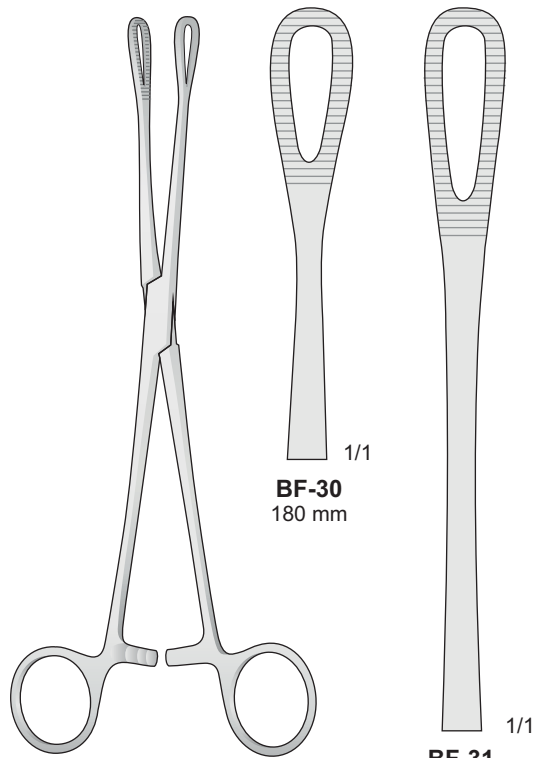
Pinzas para tampones  
Pinzas hemostáticas



COLLIN  
BF-03  
260 mm



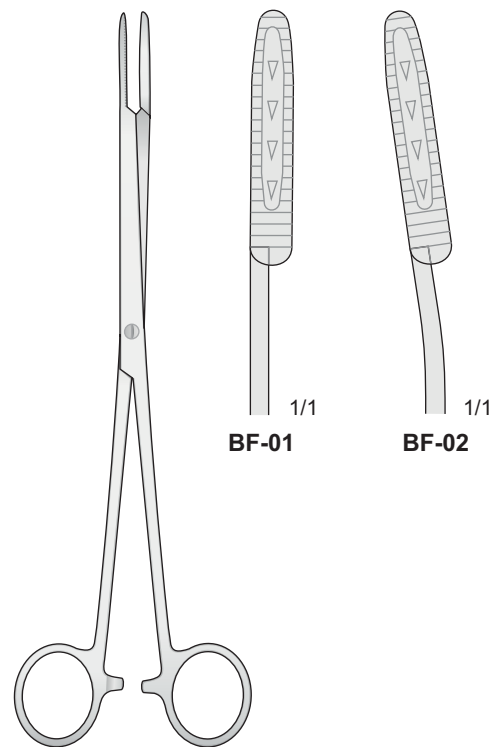
COLLIN  
BF-04  
260 mm



RAMPLEY  
BF-30/BF-31

BF-30  
180 mm

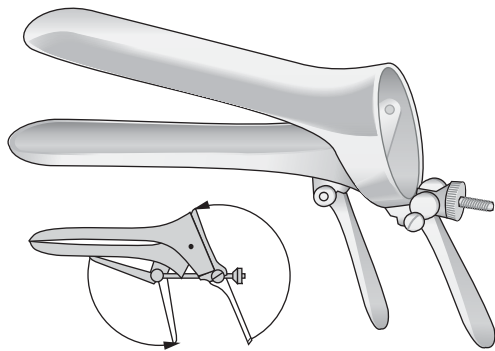
BF-31  
245 mm



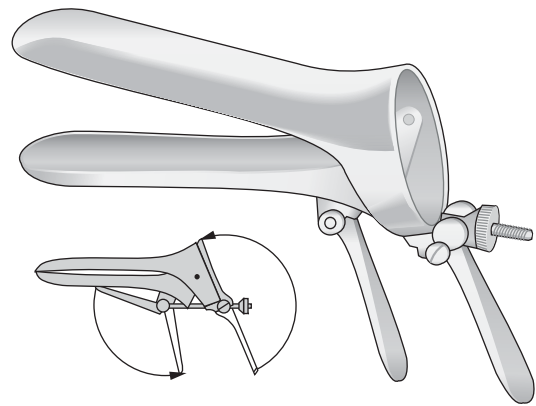
MAIER  
BF-01/BF-02  
245 mm

BF-01

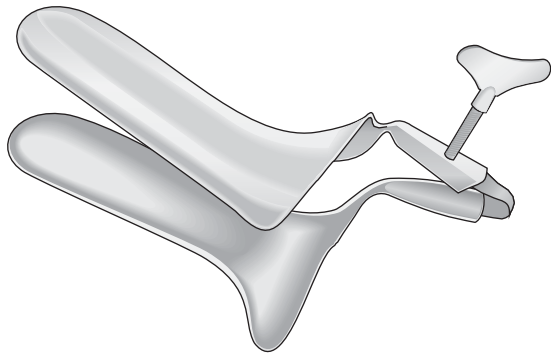
BF-02



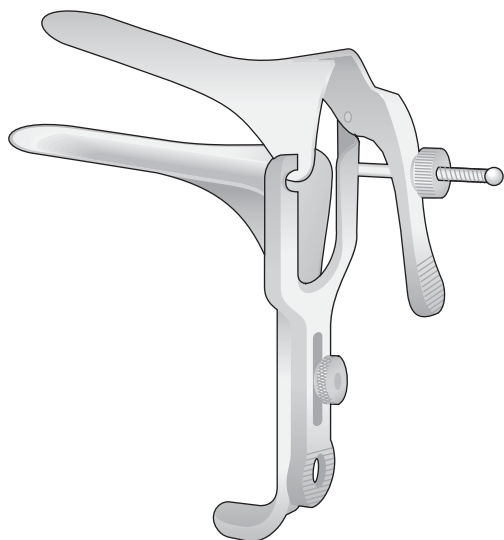
CUSCO  
**ER-49** Fig. 0 77x17 mm  
**ER-48** Fig. 1 75x33 mm  
**ER-47** Fig. 2 86x36 mm  
**ER-46** Fig. 3 97x36 mm



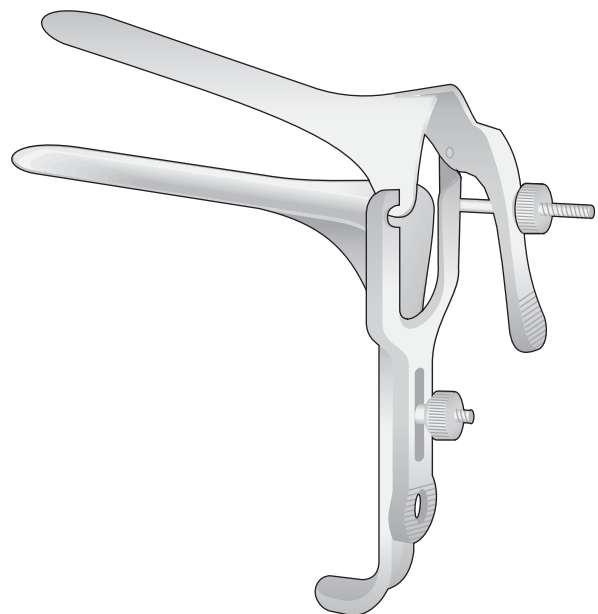
CUSCO  
 SCHWEIZER MODELL  
**ER-61** Fig.1 90x23 mm  
**ER-62** Fig.2 100x24 mm  
**ER-63** Fig.3 105x27 mm



COLLIN-STANDARD  
**ER-72** Fig. 1 90x29 mm  
**ER-73** Fig. 2 95x35 mm  
**ER-74** Fig. 3 110x40 mm



GRAVE  
**ER-91** 75x20 mm  
**ER-92** 95x30 mm  
**ER-93** 105x33 mm



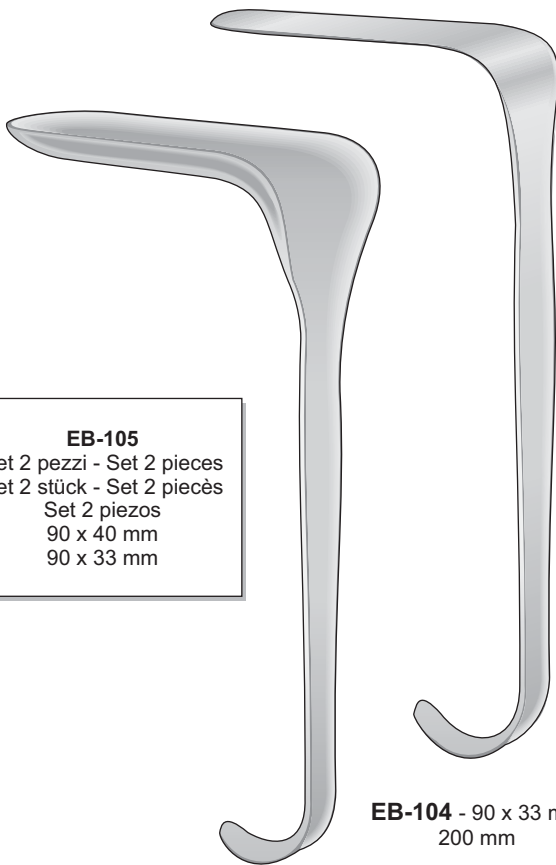
PEDERSON  
**ER-96** 100x22 mm  
**ER-97** 120x25 mm



KALLMORGEN  
**EB-101** - 70 x 40 mm  
170 mm

**EB-102** - 70 x 33 mm  
170 mm

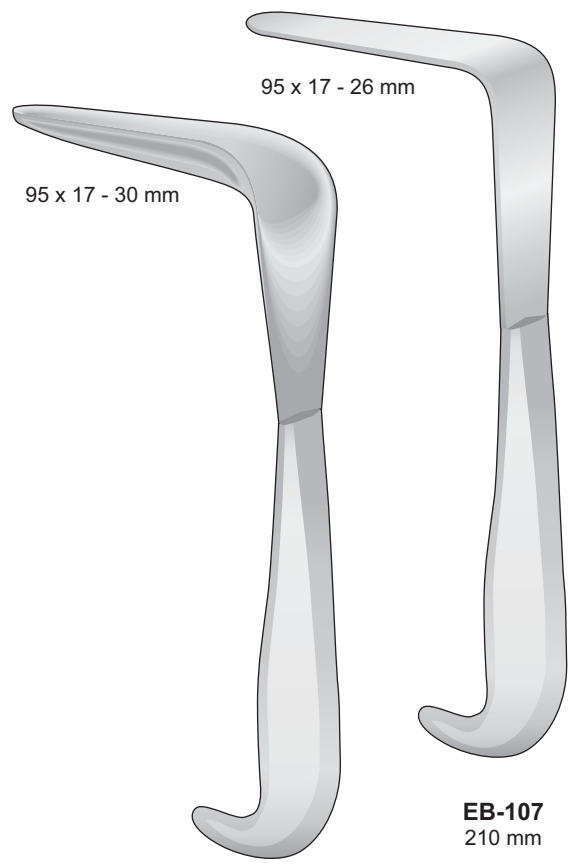
**EB-100**  
Set 2 pezzi - Set 2 pieces  
Set 2 stück - Set 2 pièces  
Set 2 piezos  
70 x 40 mm  
70 x 33 mm



KALLMORGEN  
**EB-103** - 90 x 40 mm  
200 mm

**EB-104** - 90 x 33 mm  
200 mm

**EB-105**  
Set 2 pezzi - Set 2 pieces  
Set 2 stück - Set 2 pièces  
Set 2 piezos  
90 x 40 mm  
90 x 33 mm



MATHIEU  
**EB-106**  
210 mm

**EB-107**  
210 mm

95 x 17 - 30 mm

95 x 17 - 26 mm



**Speculum e valve vaginali**

**Vaginal specula**

**Scheidenspekula und halter**

**Spéculums et valves vaginaux**

**Espéculos vaginales**

Speculum  
Spekula  
Specula  
Spéculums  
Espéculos



KRISTELLER

- Fig. 1 **EB-120** - 70 x 27 mm
- Fig. 2 **EB-121** - 75 x 30 mm
- Fig. 3 **EB-122** - 90 x 36 mm

Valva  
Halter  
Retractors  
Valves  
Valvas



KRISTELLER

- Fig. 1 **EB-123** - 75 x 23 mm
- Fig. 2 **EB-124** - 80 x 26 mm
- Fig. 3 **EB-125** - 95 x 32 mm

Speculum + Valva  
Specula + Retractor  
Spekula + Halter  
Spéculum + Valve  
Espéculo + Valva



- Fig. 1 **EB-126**
- Fig. 2 **EB-127**
- Fig. 3 **EB-128**

Speculum  
Spekula  
Specula  
Spéculums  
Espéculos



KRISTELLER

- Fig. 00 **EB-130** - 110 x 18 mm
- Fig. 0 **EB-131** - 110 x 21 mm
- Fig. 1 **EB-132** - 110 x 27 mm
- Fig. 2 **EB-133** - 110 x 30 mm
- Fig. 3 **EB-134** - 110 x 36 mm

Valva  
Halter  
Retractors  
Valves  
Valvas



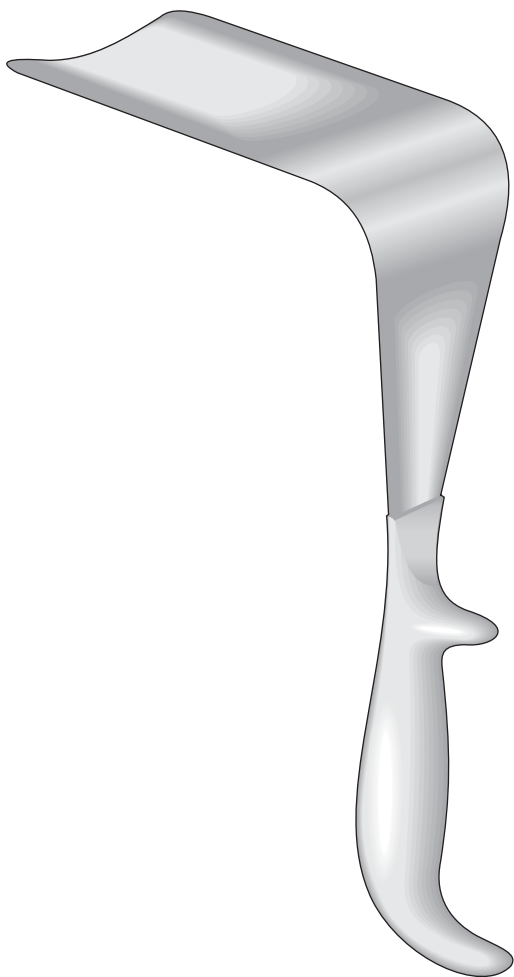
KRISTELLER

- Fig. 00 **EB-135** - 115 x 14 mm
- Fig. 0 **EB-136** - 115 x 17 mm
- Fig. 1 **EB-137** - 115 x 23 mm
- Fig. 2 **EB-138** - 115 x 26 mm
- Fig. 3 **EB-139** - 115 x 32 mm

Speculum + Valva  
Specula + Retractor  
Spekula + Halter  
Spéculum + Valve  
Espéculo + Valva



- Fig. 00 **EB-140**
- Fig. 0 **EB-141**
- Fig. 1 **EB-142**
- Fig. 2 **EB-143**
- Fig. 3 **EB-144**

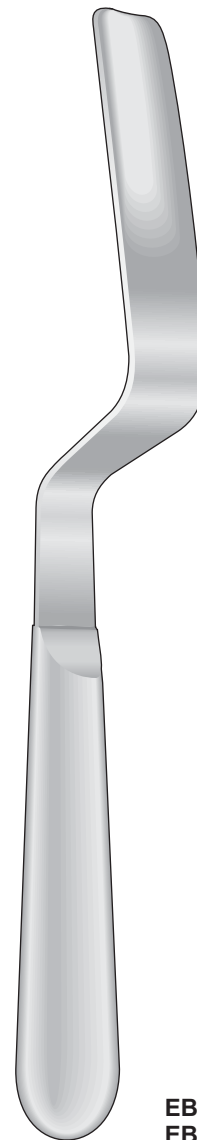


DOYEN  
EB-150/EB-166  
240 mm

Fig. 1 **EB-150** - 60 x 35 mm  
Fig. 2 **EB-151** - 90 x 35 mm  
Fig. 3 **EB-152** - 120 x 35 mm

Fig. 1 **EB-156** - 60 x 45 mm  
Fig. 2 **EB-157** - 90 x 45 mm  
Fig. 3 **EB-158** - 120 x 45 mm  
Fig. 4 **EB-160** - 160 x 45 mm

Fig. 1 **EB-162** - 60 x 60 mm  
Fig. 2 **EB-163** - 90 x 60 mm  
Fig. 3 **EB-164** - 120 x 60 mm  
Fig. 4 **EB-166** - 160 x 60 mm



LANDAU  
EB-190/EB-191  
290 mm

**EB-190** - 100 x 28 mm  
**EB-191** - 100 x 38 mm



BREISKY

- EB-170 - 100 x 20 mm
- EB-171 - 100 x 25 mm
- EB-172 - 100 x 30 mm
- EB-173 - 100 x 35 mm
- EB-174 - 100 x 40 mm  
290 mm

BREISKY

- EB-175 - 130 x 20 mm
- EB-176 - 130 x 25 mm
- EB-177 - 130 x 30 mm
- EB-178 - 130 x 35 mm
- EB-179 - 130 x 40 mm  
320 mm

BREISKY

- EB-184 - 160 x 40 mm  
350 mm

BREISKY

- EB-189 - 180 x 40 mm  
370 mm





Dilatatori uterini

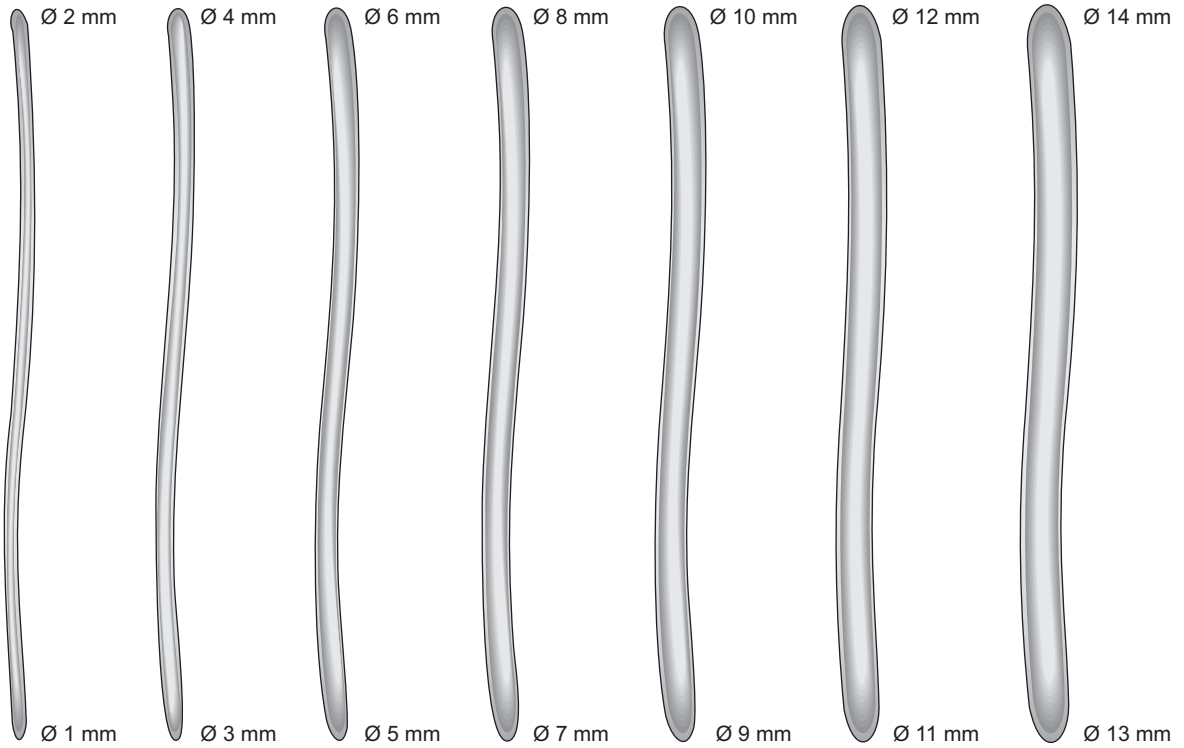
Uterine dilators

Uterus-Dilatatoren

Dilatateurs du col de l'utérus

Dilatadores uterinos

Hegar Dilatatori - Hegar Dilatators - Hegar Dilatatoren - Hegar Dilateur - Hegar Dilatadores



**ER-120**  
200 mm

**ER-121**  
200 mm

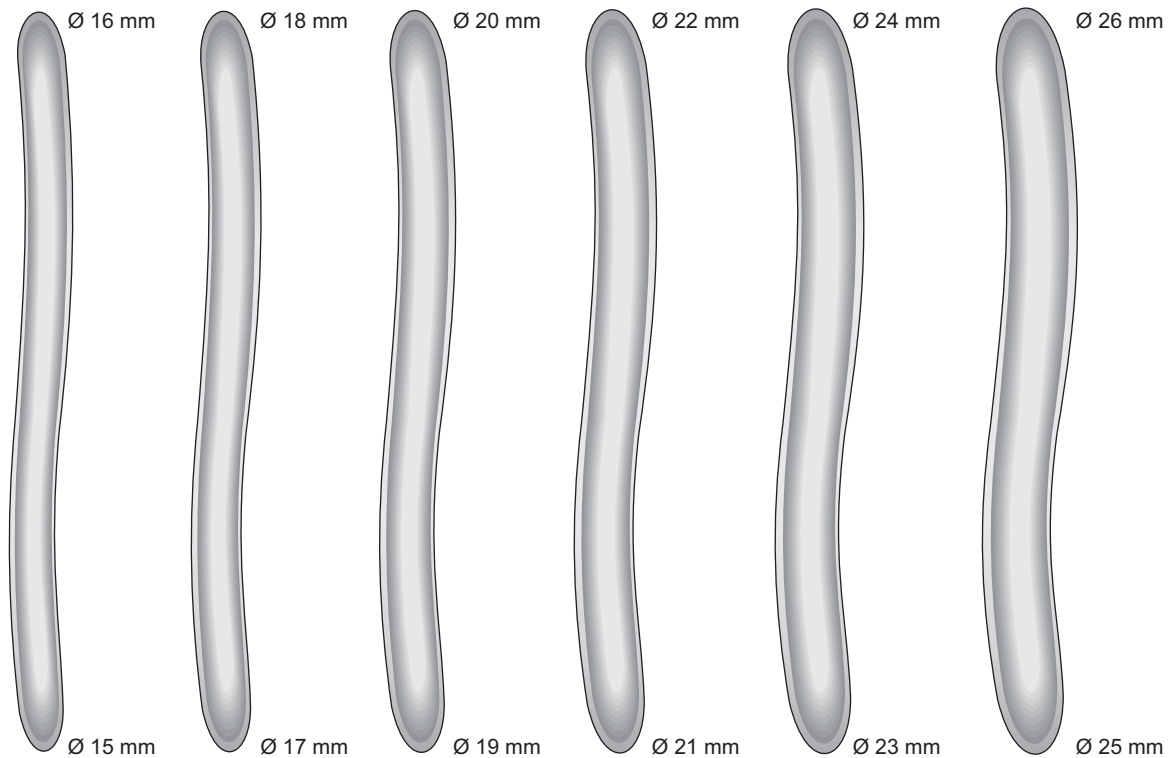
**ER-122**  
200 mm

**ER-123**  
200 mm

**ER-124**  
200 mm

**ER-125**  
200 mm

**ER-126**  
200 mm



**ER-127**  
200 mm

**ER-128**  
200 mm

**ER-129**  
200 mm

**ER-130**  
200 mm

**ER-131**  
200 mm

**ER-132**  
200 mm

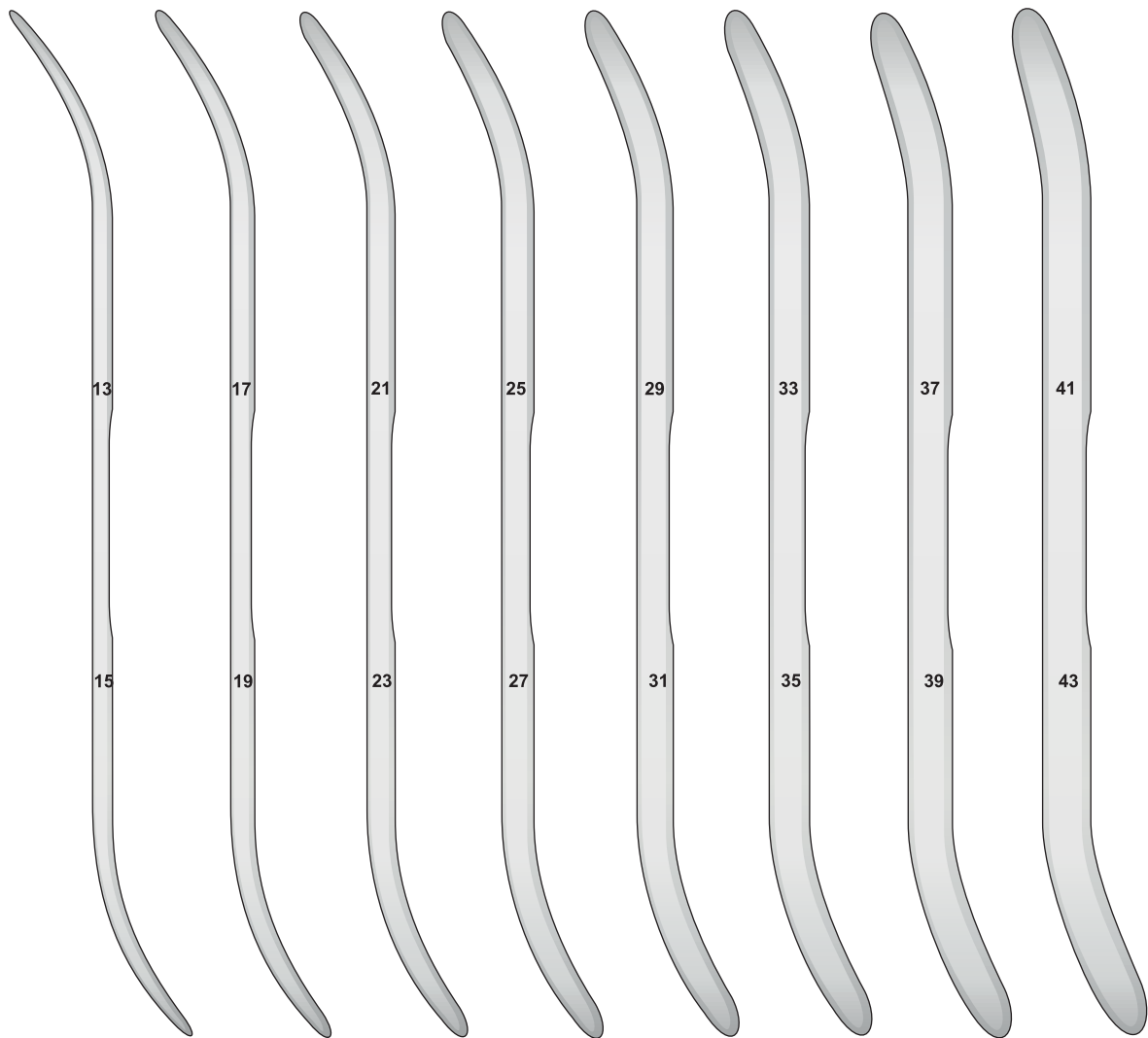


Pratt Dilatori - Pratt Dilators - Pratt Dilatoren  
Pratt Dilateur - Pratt Diladores

**ER-110**  
 Set completo dilatatori 8 pezzi  
 Set complete with 8 pieces  
 Satz-Dilatator, komplett, 8 Stück  
 Jeu complet avec 8 pieces  
 Juego completo con 8 piezas

Fig.	mm
13/15	4,5/5,0
17/19	5,6/6,3
21/23	7,0/7,6
25/27	8,3/9,0
29/31	9,6/10,3
33/35	11,0/11,6
37/39	12,3/13,0
41/43	13,6/14,3

La misura è in French  
Breite in French



**ER-111**  
260 mm

**ER-112**  
260 mm

**ER-113**  
260 mm

**ER-114**  
260 mm

**ER-115**  
260 mm

**ER-116**  
260 mm

**ER-117**  
260 mm

**ER-118**  
260 mm



- EB-51 1 mm
- EB-52 2 mm
- EB-53 3 mm
- EB-54 4 mm
- EB-55 5 mm
- EB-56 6 mm
- EB-57 7 mm
- EB-58 8 mm
- EB-59 9 mm
- EB-60 10 mm
- EB-61 11 mm
- EB-62 12 mm
- EB-63 13 mm

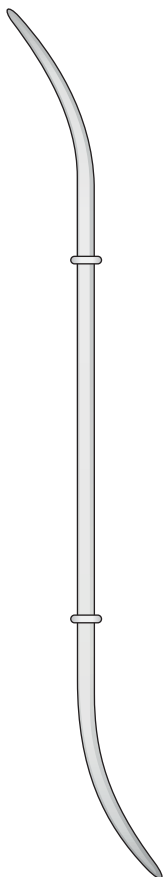
- EB-64 14 mm
- EB-65 15 mm
- EB-66 16 mm
- EB-67 17 mm
- EB-68 18 mm
- EB-69 19 mm
- EB-70 20 mm
- EB-71 21 mm
- EB-72 22 mm
- EB-73 23 mm
- EB-74 24 mm
- EB-75 25 mm
- EB-76 26 mm

- EB-77 1½ mm
- EB-78 2½ mm
- EB-79 3½ mm
- EB-80 4½ mm
- EB-81 5½ mm
- EB-82 6½ mm
- EB-83 7½ mm
- EB-84 8½ mm
- EB-85 9½ mm
- EB-86 10½ mm
- EB-87 11½ mm
- EB-88 12½ mm
- EB-89 13½ mm

- EB-90 14½ mm
- EB-91 15½ mm
- EB-92 16½ mm
- EB-93 17½ mm

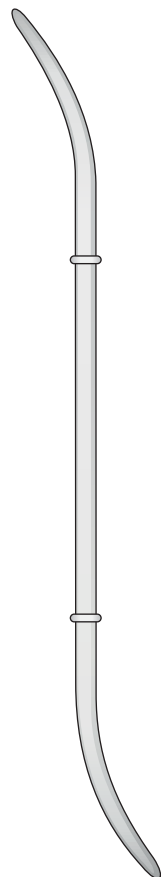
HEGAR  
EB-51/EB-93  
185 mm

Fig. 9/10  
Ø 4,5/5,0 mm



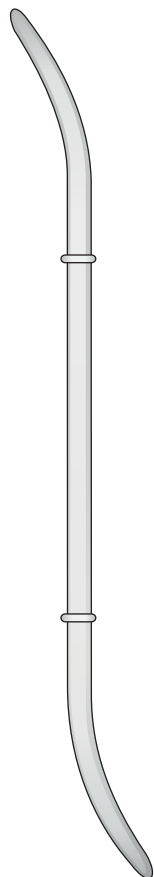
HANK  
ER-161  
260 mm

Fig. 11/12  
Ø 5,5/6,0 mm



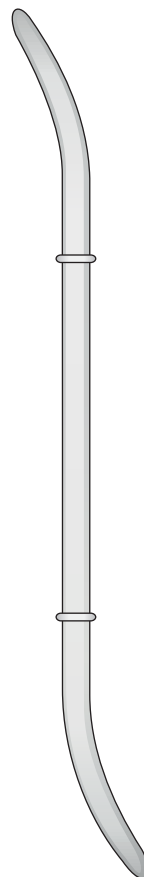
HANK  
ER-162  
260 mm

Fig. 13/14  
Ø 6,5/7,0 mm



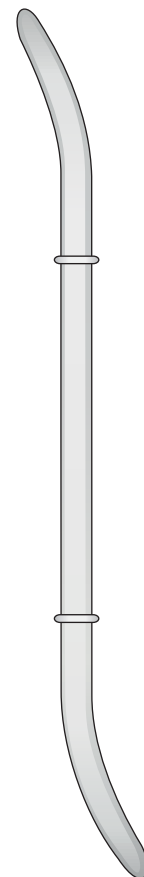
HANK  
ER-163  
260 mm

Fig. 15/16  
Ø 7,5/8,0 mm



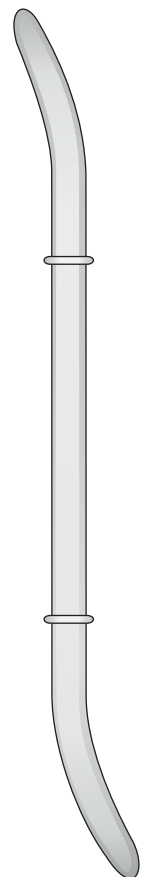
HANK  
ER-164  
260 mm

Fig. 17/18  
Ø 8,5/9,0 mm



HANK  
ER-165  
260 mm

Fig. 19/20  
Ø 9,5/10 mm



HANK  
ER-166  
260 mm



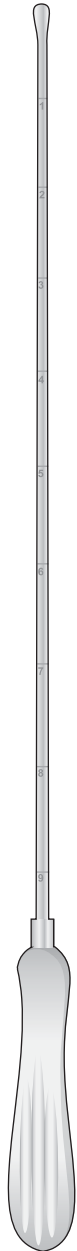
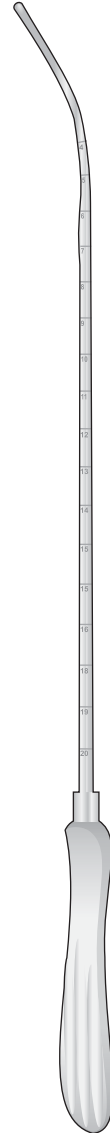
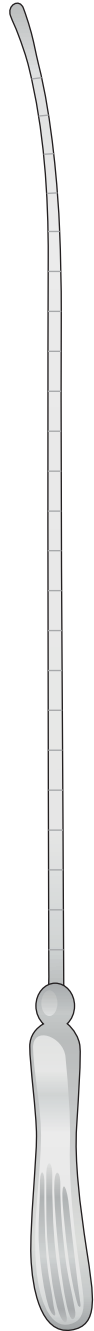
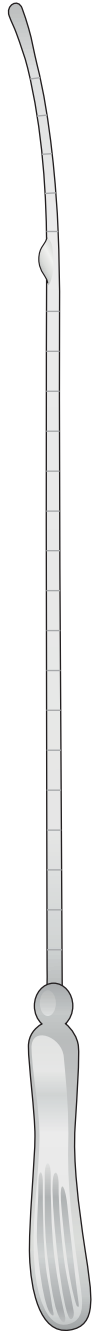
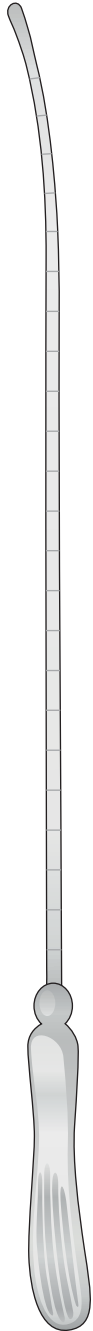
Graduati in centimetri  
Graduated in centimeters  
Zentimetereinteilung  
Gradué en centimètres  
Graduado en centímetros

Malleabile  
Malleable  
Biègsam  
Malléables  
Maleables

Malleabile  
Malleable  
Biègsam  
Malléables  
Maleables

Rigido  
Rigid  
Fest  
Rigides  
Rigidos

Malleabile  
Malleable  
Biègsam  
Malléables  
Maleables



**ER-100**  
Ø 2 mm  
**ER-101**  
Ø 3 mm  
**ER-102**  
Ø 4 mm

**ER-104**  
Ø 3 mm  
**ER-105**  
Ø 4 mm

SIMS  
**ER-100/ER-102**  
320 mm

SIMPSON  
**ER-103** Ø 3 mm  
320 mm

SIMS  
**ER-104/ER-105**  
320 mm

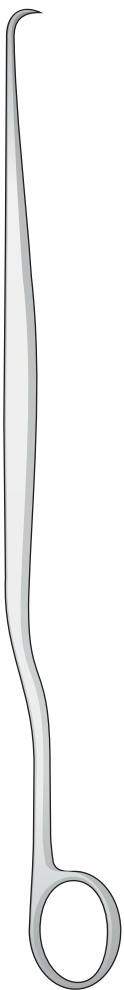
VALLEIX  
**ER-107** Ø 4 mm  
265 mm

MARTIN  
**ER-106** Ø 3 mm  
300 mm

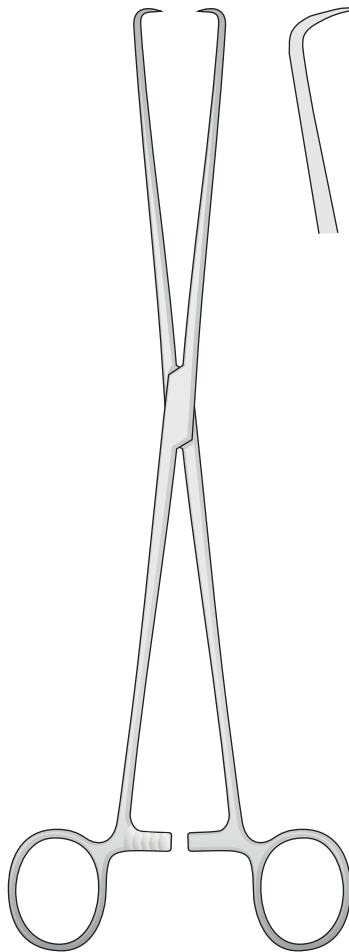
MAYO  
**ER-108** Ø 5 mm  
330 mm



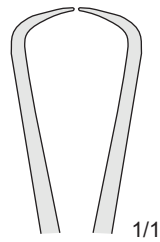
Amniotomo per la  
vescica amniotica  
Amniotome for the  
amnion bladder  
Amniotom für die  
Amnionblase  
Amniotome pour la  
vésicule amniotique  
Amniõtomo para la  
vesicula amniõtica



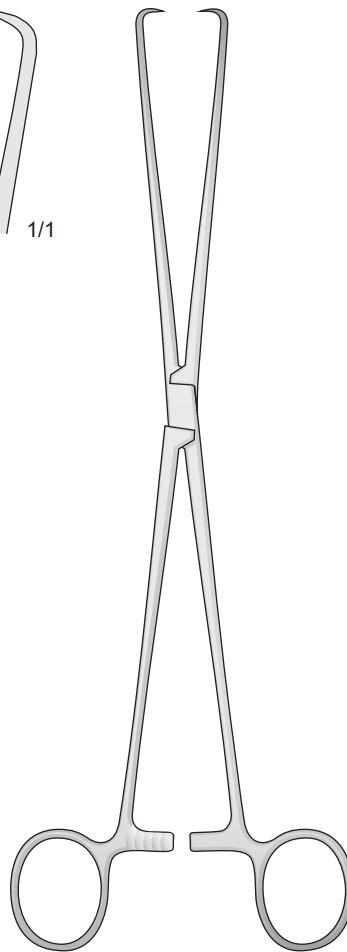
BEACHAM  
**BF-55**  
260 mm



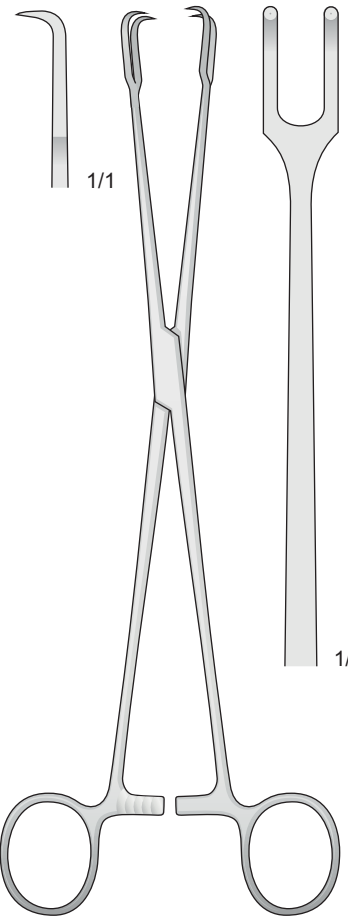
BRAUN  
**BF-49**  
250 mm



1/1



POZZI  
**BF-60**  
250 mm



SCHROEDER  
**BF-59**  
240 mm

1/1

1/1



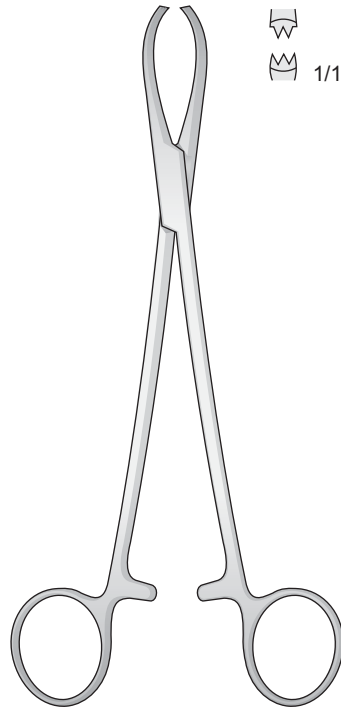
Pinze uterine

Uterine tenaculum forceps

Hakenzangen

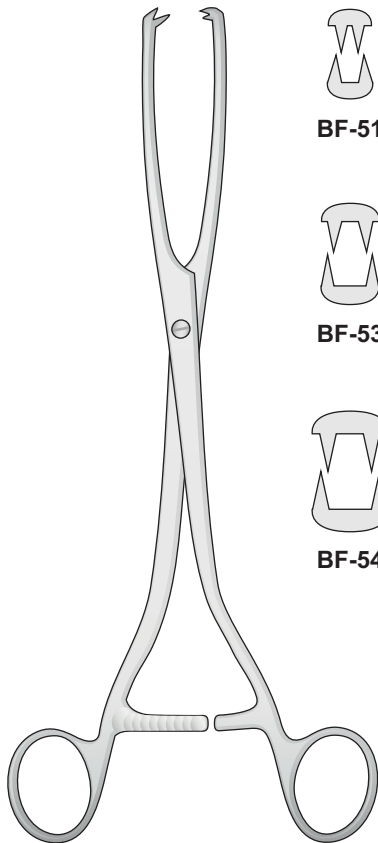
Pinces pour l'utérus

Pinzas para coger el cuello del útero

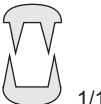


LITTLEWOOD  
EB-25  
185 mm

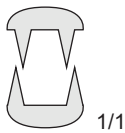
Con curvatura laterale  
Curved Sideway  
Seitwärts Gebogen  
Courbes sur le côté  
Curvas laterales



BF-51

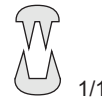
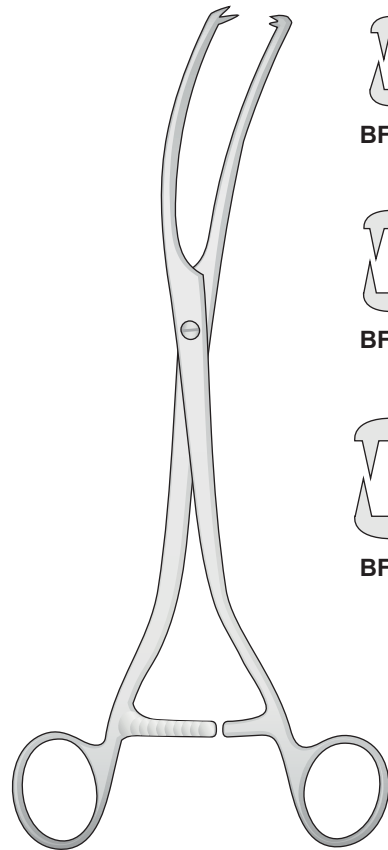


BF-53

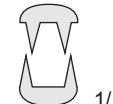


BF-54

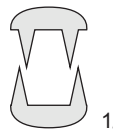
MUSEUX  
BF-51/BF-54  
240 mm



BF-61

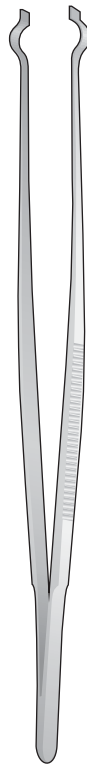


BF-62

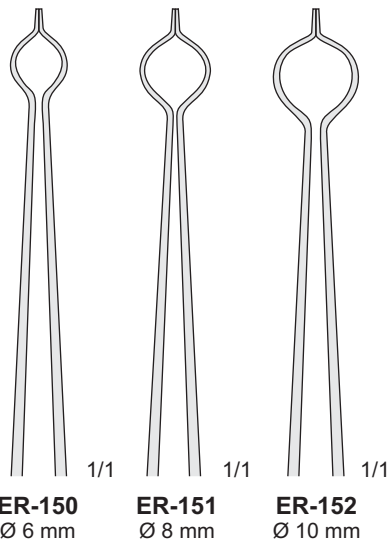


BF-63

MUSEUX  
BF-61/BF-63  
240 mm



NEUBÜSER  
ER-150/ER-152  
200 mm



ER-150  
Ø 6 mm

ER-151  
Ø 8 mm

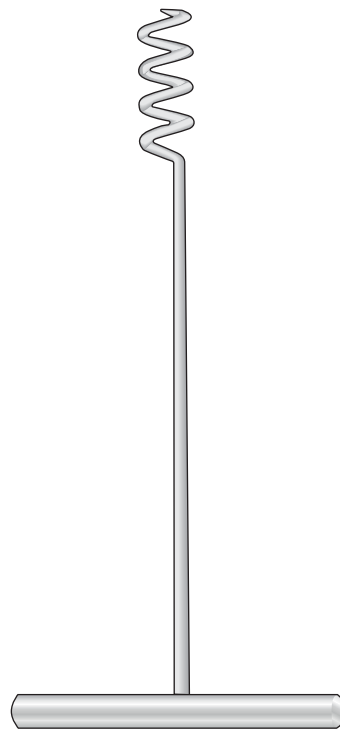
ER-152  
Ø 10 mm

Pinzette per la presa delle tube  
Tubal seizing forceps  
Tubenfasspinzetten  
Pinces pour saisir les tubes

Elevatori per miomi  
Myoma screw  
Myomheber  
Tracteur pour fibromes  
Tiramomas para fibromas



DOYEN  
EB-15  
150 mm



DOYEN  
EB-16  
170 mm



Curette di aspirazione  
per biopsia

Uterine biopsy  
aspirating curettes

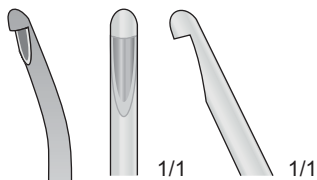
Uterus Biopsie  
Saugküretten

Curettes aspirantes  
à biopsie de l'utérus

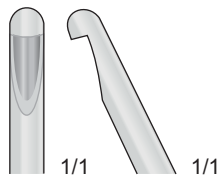
Curetas aspiradoras para  
la biopsia uterina

Curette per biopsia endouterina  
Endometrial Biopsy curette  
Endometrium-Strickkürette  
Curette pour biopsie intra-utérines  
Cureta para biopsia endo-uterina

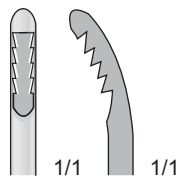
Curette per biopsia endocervicale  
Endocervical Biopsy Curettes  
Endocervix-Biopsieküretten  
Curettes pour biopsies  
endo-cervicales



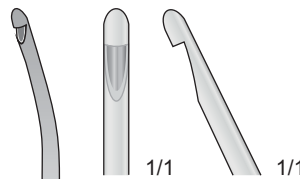
**GF-108**  
3,5 mm



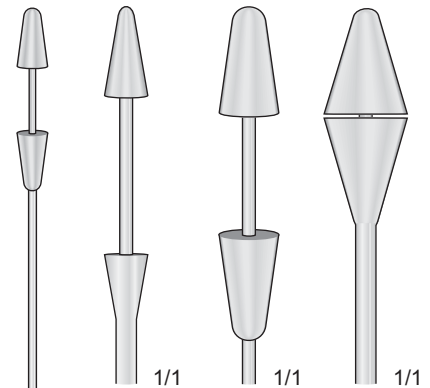
**GF-109**  
5 mm



**GF-135**  
Ø 1 mm  
**GF-136**  
Ø 2 mm  
**GF-137**  
Ø 3 mm  
**GF-138**  
Ø 4 mm



**RANDALL**  
**GF-139**  
230 mm



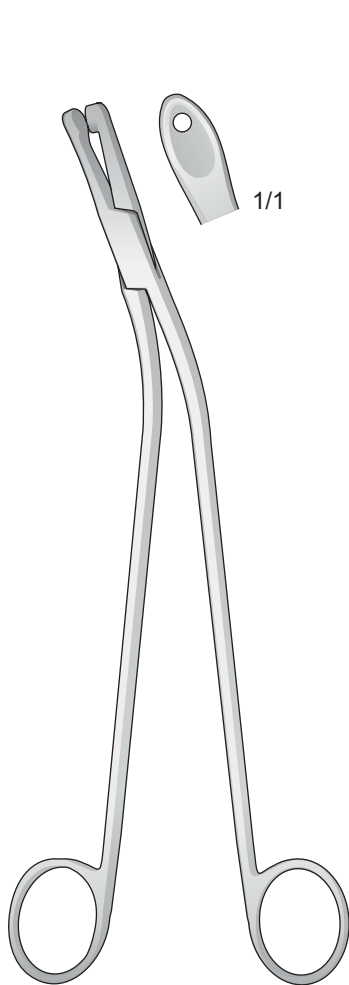
**ER-77**  
Ø 5,7 mm  
**ER-78**  
Ø 8 mm  
**ER-79**  
Ø 11 mm

**GUSBERG**  
**ER-77/ER-79**  
240 mm

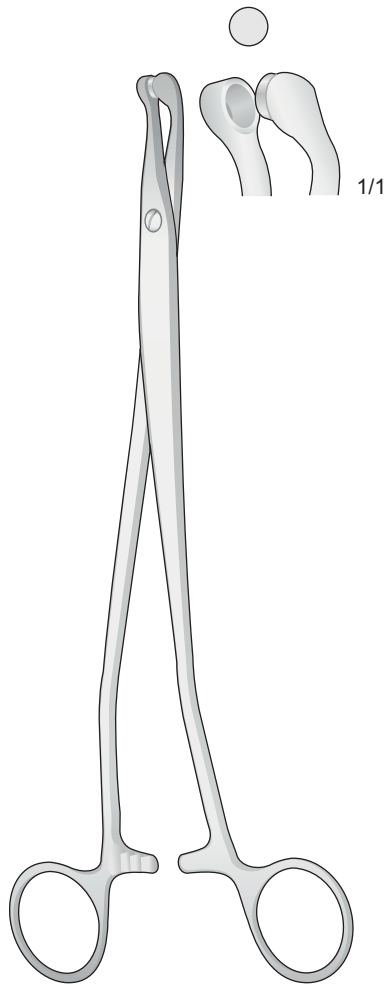
**MÜNCHEN**  
**GF-108/GF-109**  
270 mm

**NOVAK**  
**GF-135/GF-138**  
230 mm

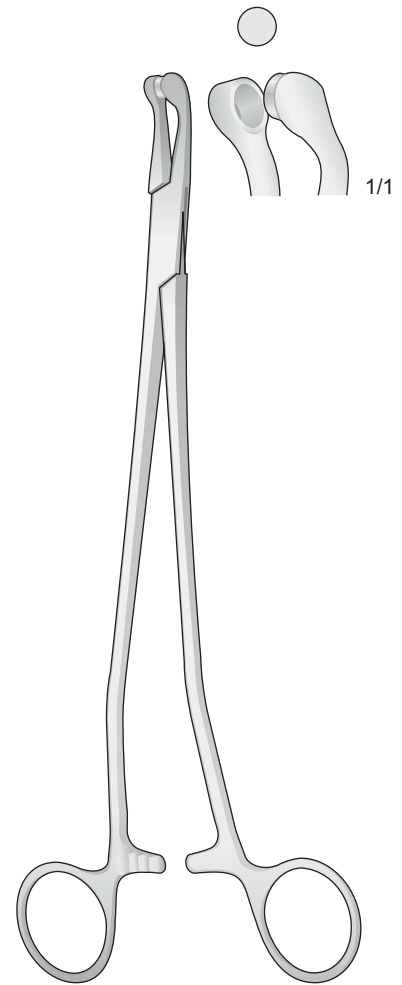




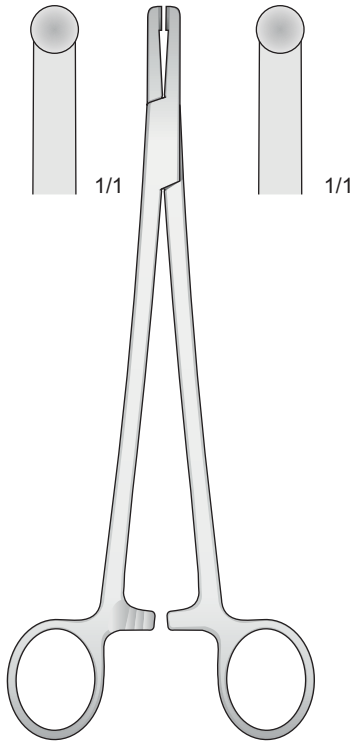
GELLHORN  
**FF-30**  
230 mm



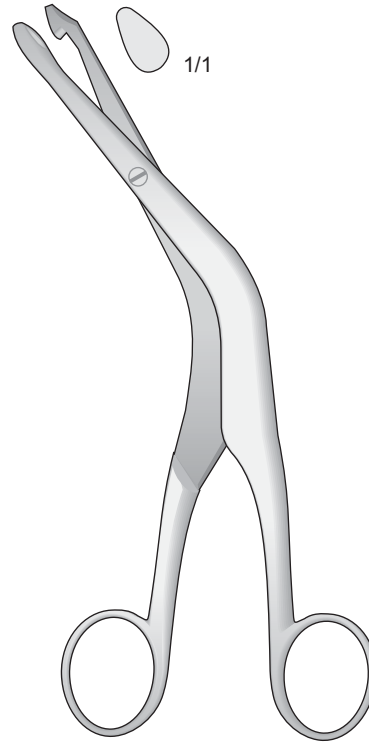
THOMS-GAYLOR  
**FF-32**  
240 mm



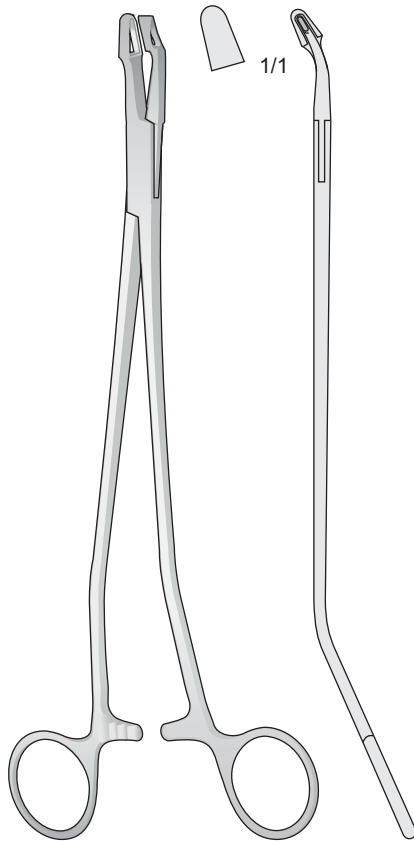
THOMS-GAYLOR  
**FF-33** 220 mm  
**FF-34** 240 mm



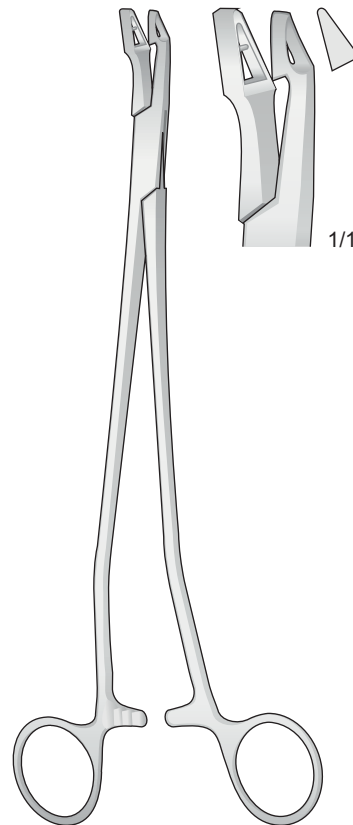
**DB-150**  
205 mm



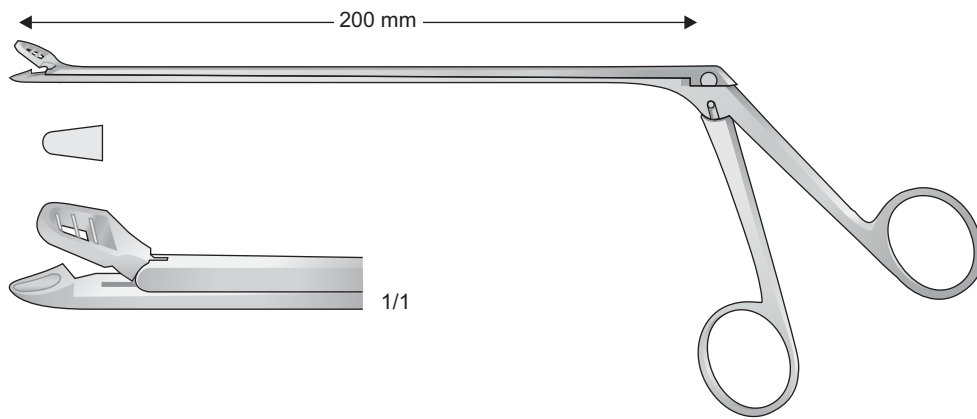
**FAURE**  
**FF-31**  
210 mm



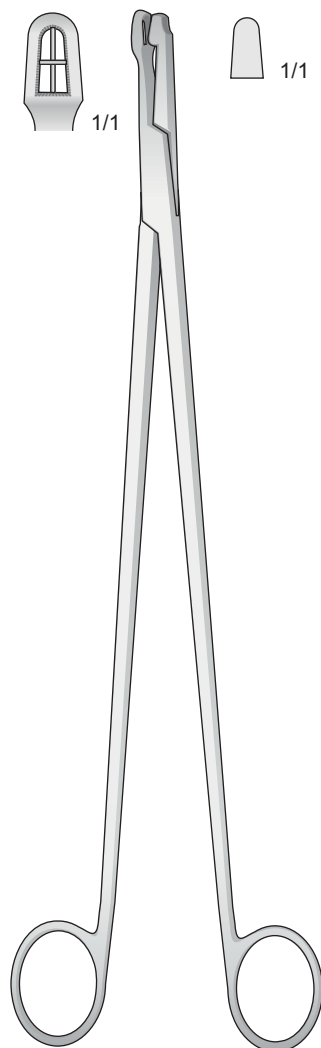
**VAN DOREN**  
**FF-39**  
250 mm



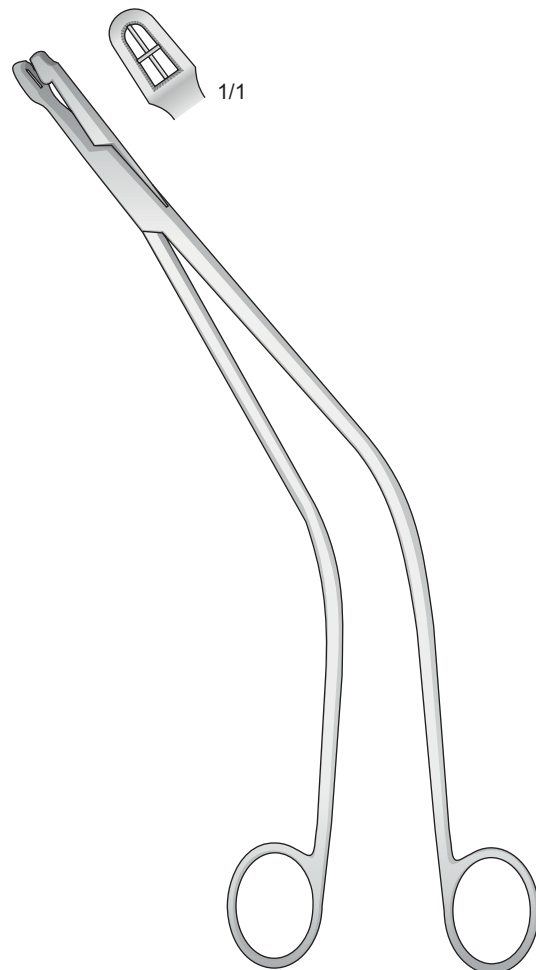
**VAN DOREN**  
**FF-38**  
240 mm



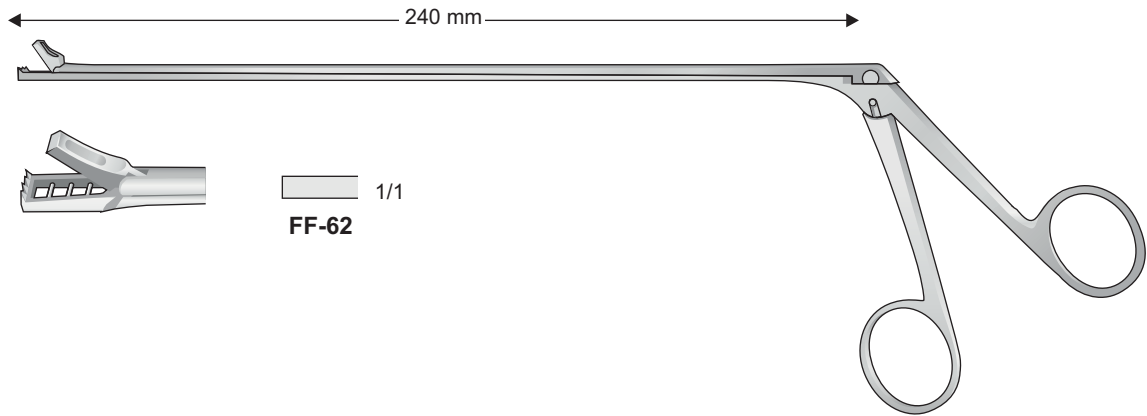
ALEXANDER  
FF-64



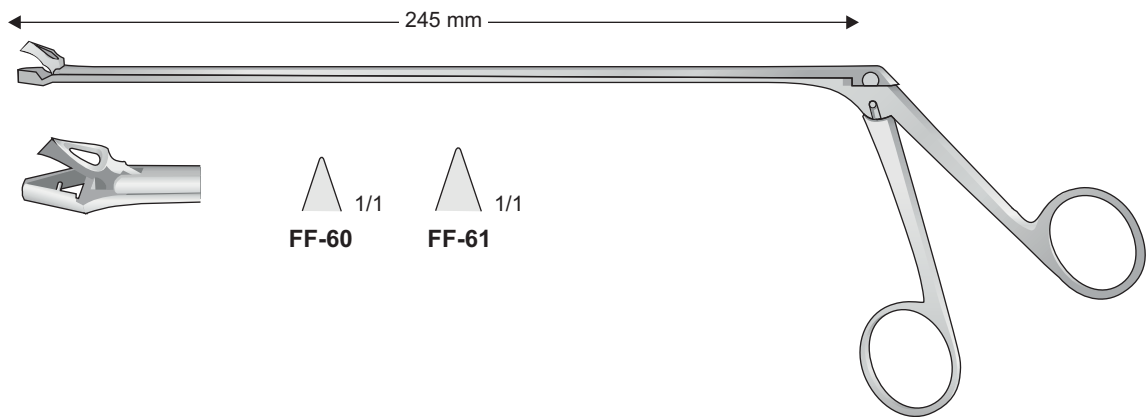
SCHUBERT  
FF-35 210 mm  
FF-36 290 mm



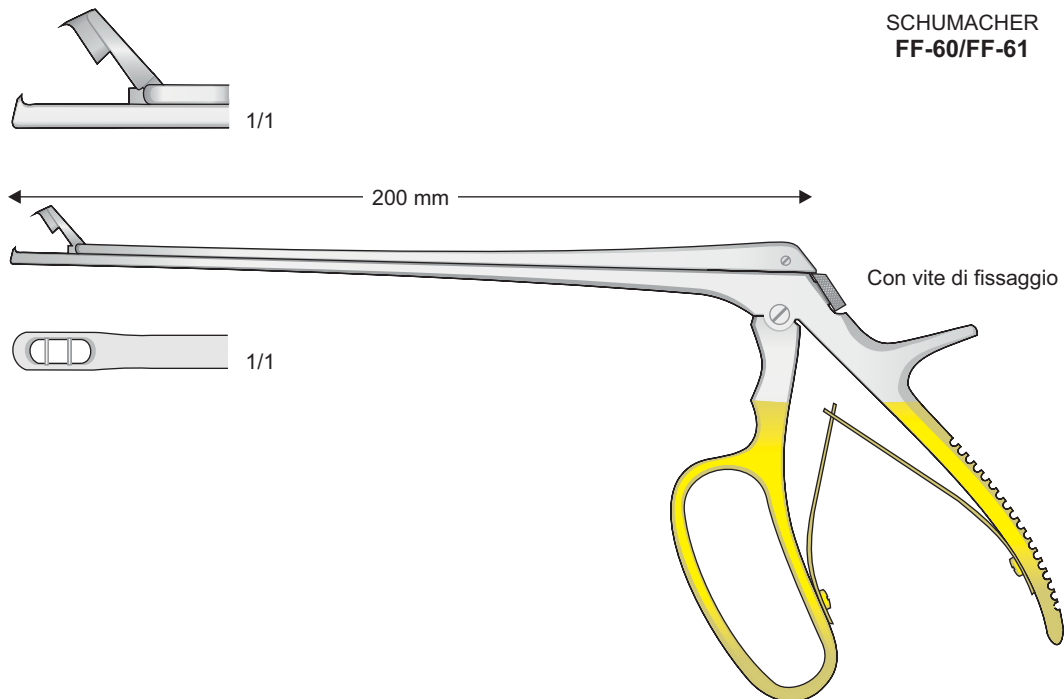
SCHUBERT  
FF-37  
260 mm



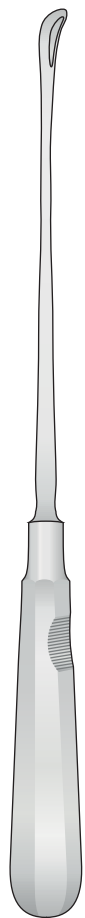
KEVORKIAN  
FF-62



SCHUMACHER  
FF-60/FF-61

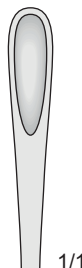


TISCHLER-MORGAN  
FF-59



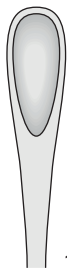
**LUER-KÖRTE**  
**EB-21/EB-23**  
260 mm

5,5 mm



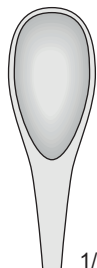
**EB-21**  
1/1

7 mm

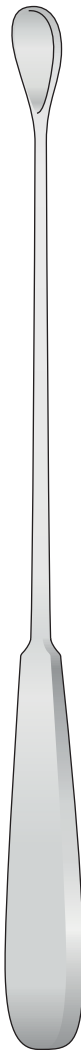


**EB-22**  
1/1

11 mm



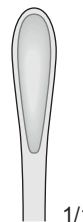
**EB-23**  
1/1



**GOURDET**  
**ER-80/ER-84**  
280 mm

Smusse - Blunt  
Stumpf - Mousset  
Romo

6 mm



**ER-80**  
1/1

8 mm



**ER-81**  
1/1

10 mm



**ER-82**  
1/1

12 mm

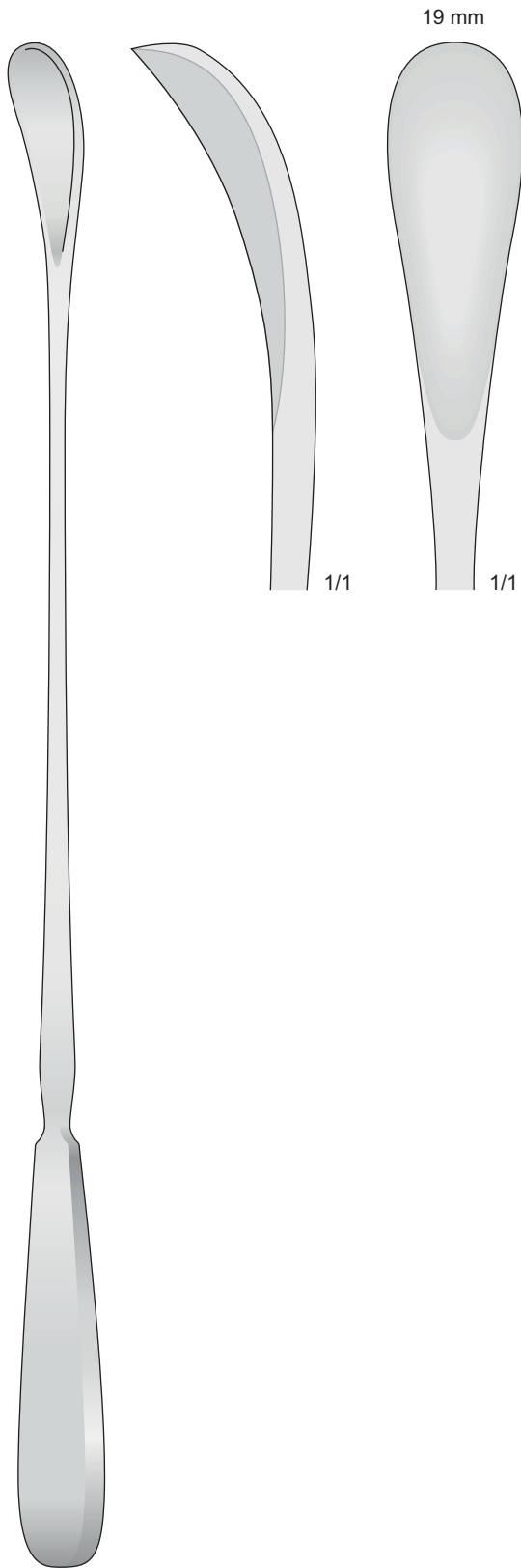


**ER-83**  
1/1

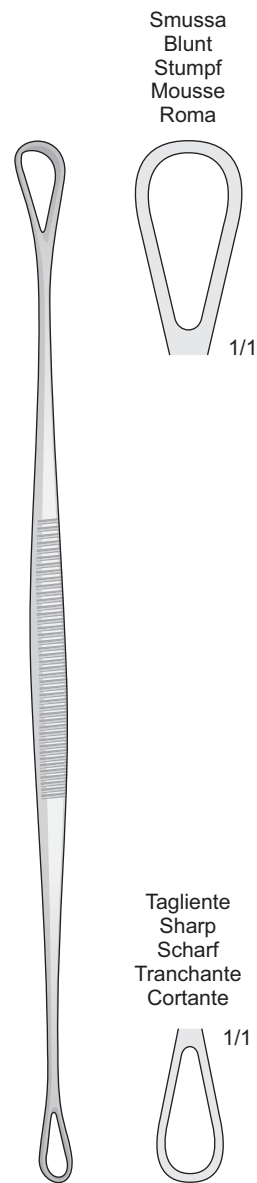
14 mm



**ER-84**  
1/1



WALLICH  
ER-90  
420 mm

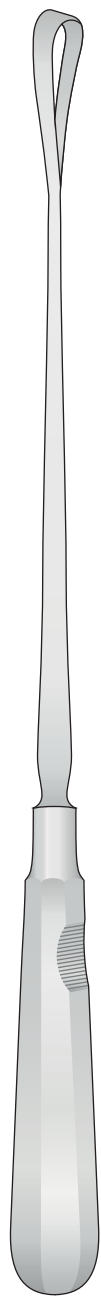
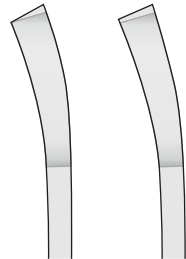


BLAKE  
ER-88  
275 mm



Taglienti  
Scharp  
Scharf  
Tranchantes  
Cortantes

Smussa  
Blunt  
Stumpf  
Mousse  
Romas



RECAMIER  
ER-11/ER-28  
310 mm



1/1



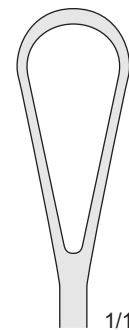
1/1



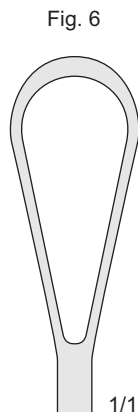
1/1



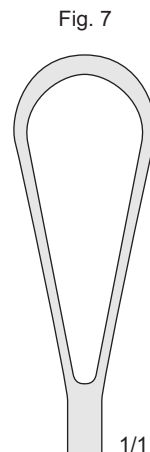
1/1



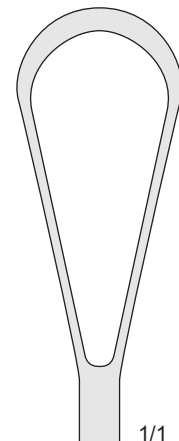
1/1



1/1

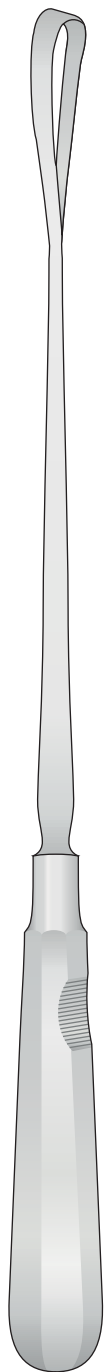


1/1

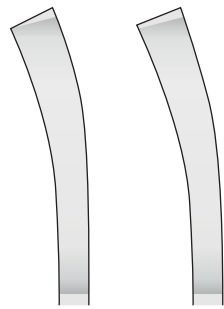


1/1

Fig.	Larghezza Width Breite	Taglienti-rigide Sharp-rigid Scharf-fest Tranchantes-rigides Cortantes-rigidas	Smusse-rigide Blunt-rigid Stumpf-fest Mousse-rigides Romas-rigidas
1	4 mm	<b>ER-11</b>	<b>ER-21</b>
2	6 mm	<b>ER-12</b>	<b>ER-22</b>
3	8 mm	<b>ER-13</b>	<b>ER-23</b>
4	10 mm	<b>ER-14</b>	<b>ER-24</b>
5	12 mm	<b>ER-15</b>	<b>ER-25</b>
6	14 mm	<b>ER-16</b>	<b>ER-26</b>
7	16 mm	<b>ER-17</b>	<b>ER-27</b>
8	18 mm	<b>ER-18</b>	<b>ER-28</b>



BUMM  
ER-31/ER-42  
310 mm



Tagliente	Smussa
Scharp	Blunt
Scharf	Stumpf
Tranchantes	Mousse
Cortantes	Romas

Malleabile  
Malleable  
Biegsam  
Souples  
Maleables

Fig. 3

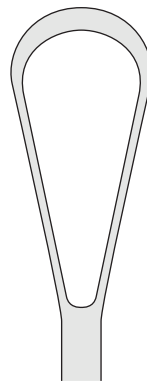
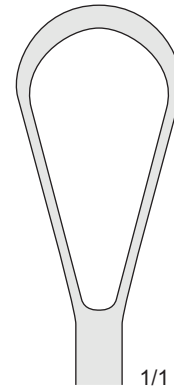


Fig. 4



1/1

Fig.	Larghezza Width Breite	Taglienti Sharp Scharf Tranchantes Cortantes	Smusse Blunt Stumpf Mousse Romas
3	18 mm	<b>ER-31</b>	<b>ER-41</b>
4	20 mm	<b>ER-32</b>	<b>ER-42</b>

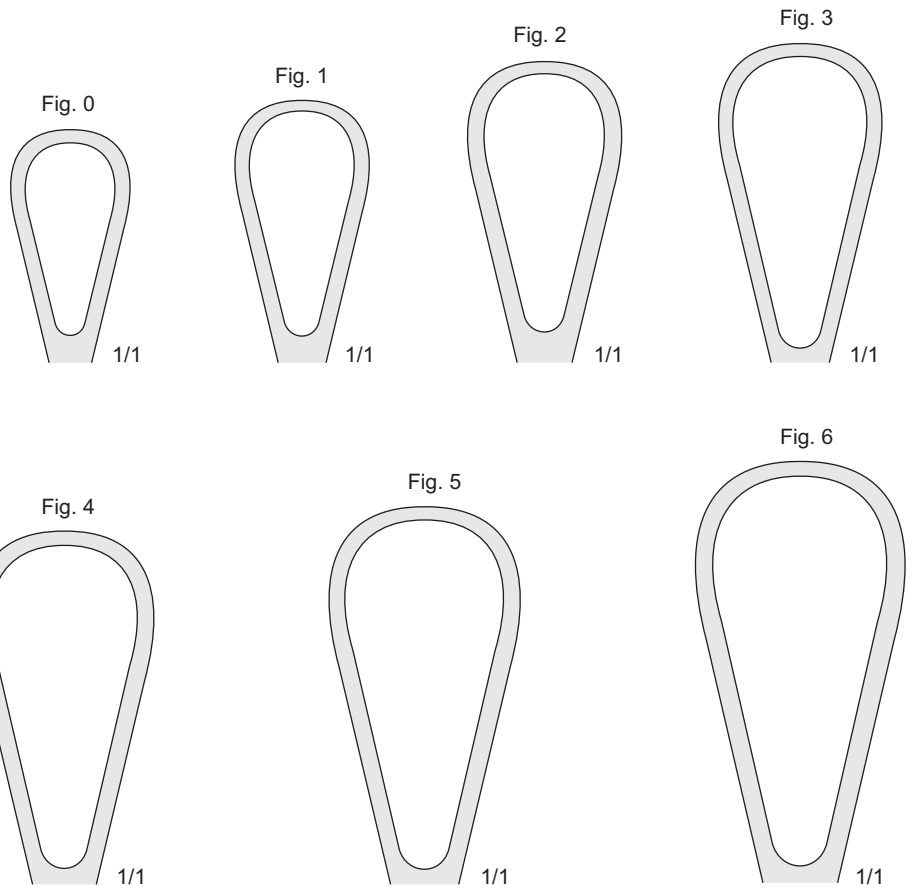




Fig.	Larghezza Breite Width	Smusse malleabili - Blunt malleable Stumpf biegsam - Mousse malléables Romas maleables
0	16 mm	<b>ER-140</b>
1	18 mm	<b>ER-141</b>
2	19,5 mm	<b>ER-142</b>
3	21,5 mm	<b>ER-143</b>
4	23,5 mm	<b>ER-144</b>
5	26 mm	<b>ER-145</b>
6	28,5 mm	<b>ER-146</b>



BUMM  
**ER-140/ER-146**  
290 mm





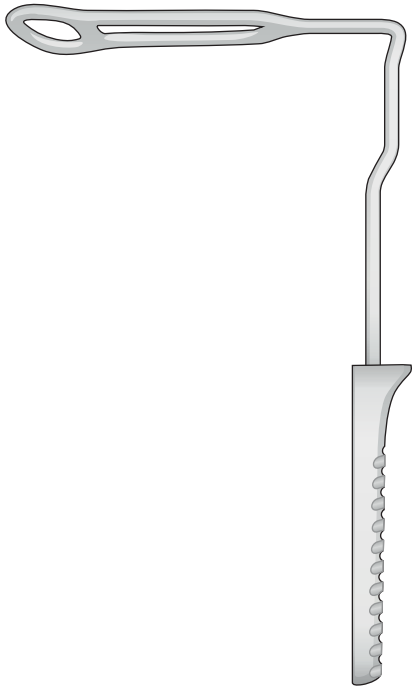
Speculum vaginali  
e forcipe

Vaginal specule  
and Midwifery forceps

Scheidenspekulum  
und Geburtszange

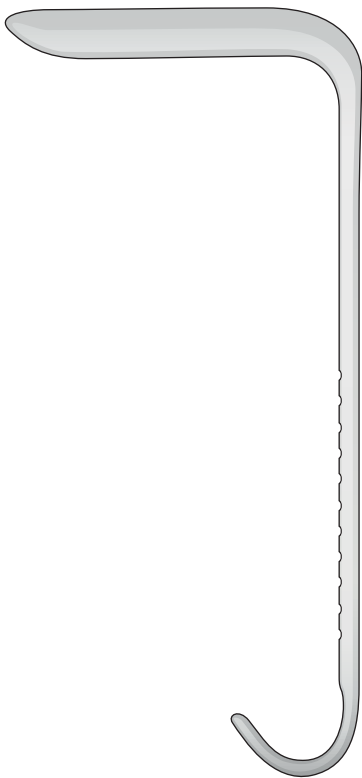
Speculum  
et forceps

Pinzas para el utero  
y obstétricos

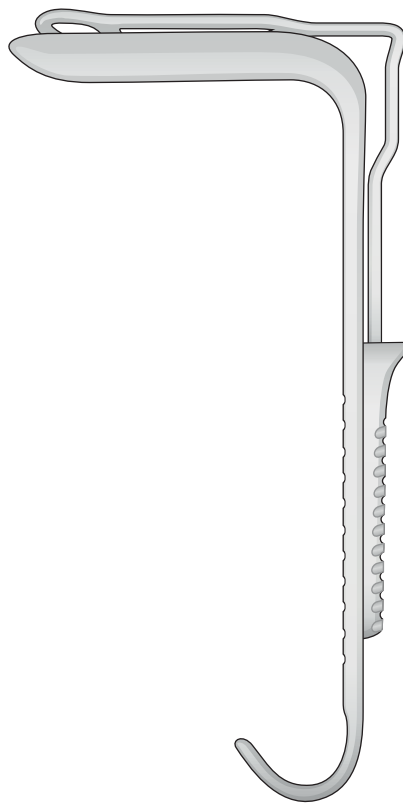


GENTOFT  
**ER-50**  
210 mm

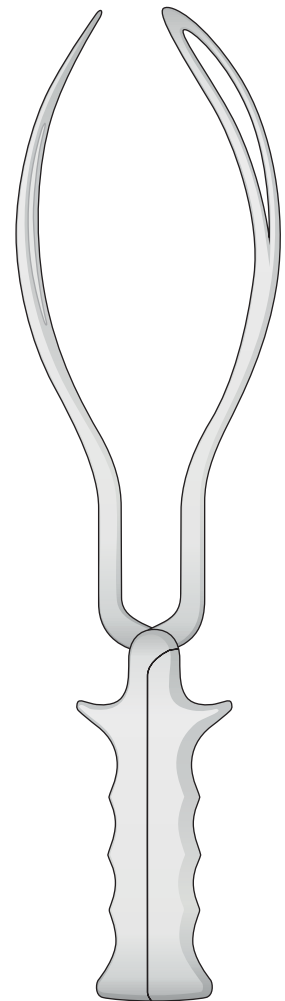
Set 2 pezzi  
Set 2 pieces  
Set 2 Stück  
Set 2 pièces  
Set 2 piezas  
**ER-50 + ER-51**



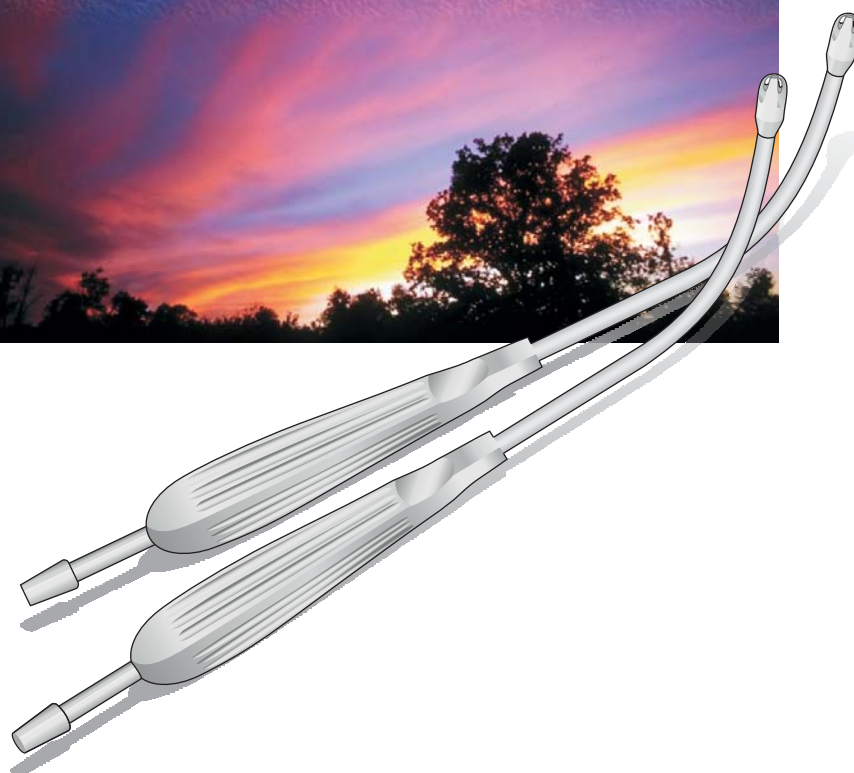
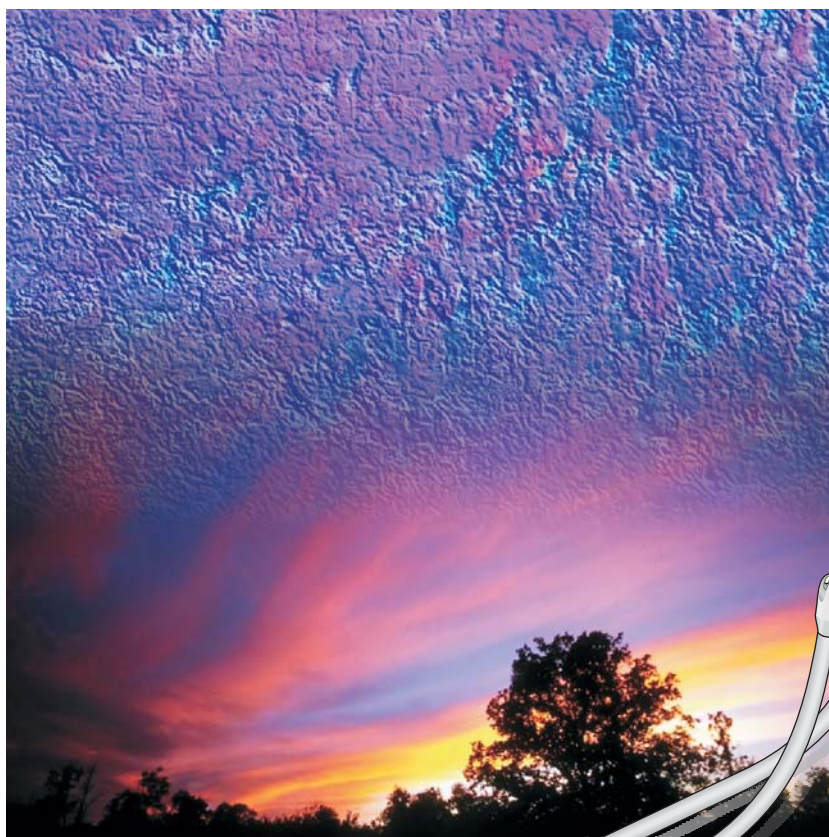
FENO  
**ER-51**  
230 mm



**ER-53**  
230 mm



SIMPSON-BRAUN  
**ER-52**  
365 mm



17

Cannule per aspirazione  
Suctions tubes  
Absaugkanülen  
Canules aspiratrices  
Cánulas aspiradoras





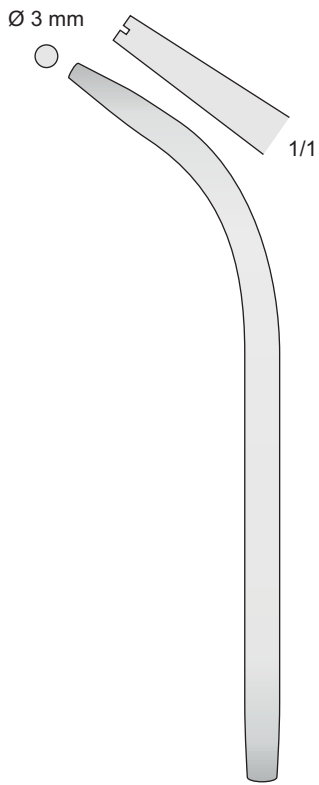
Cannule per aspirazione

Suctions tubes

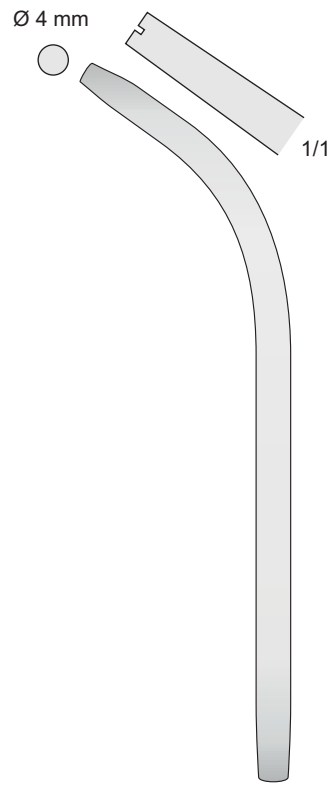
Absaugkanülen

Canules aspiratrices

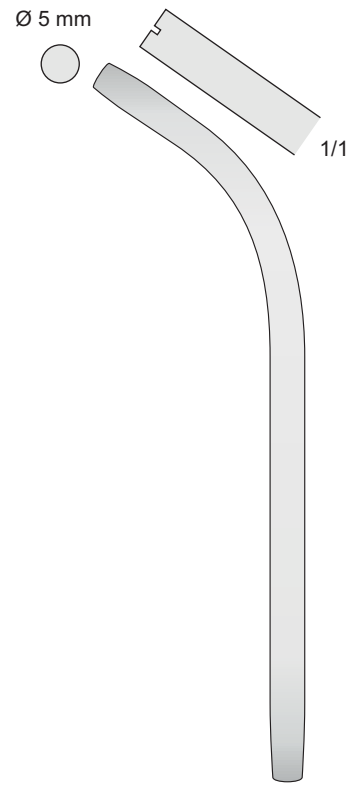
Cánulas aspiradoras



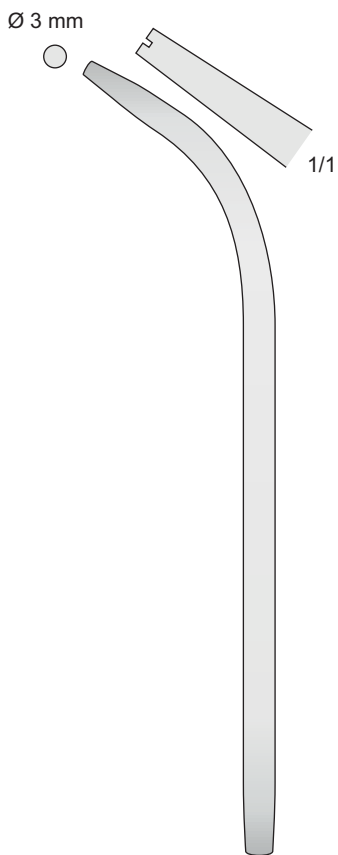
**GF-30**  
140 mm



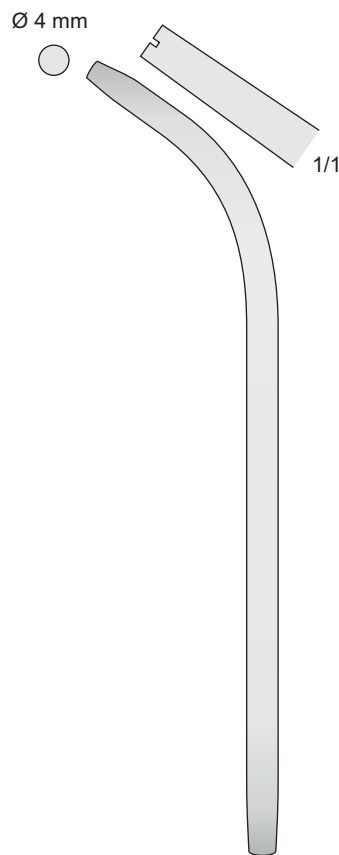
**GF-31**  
140 mm



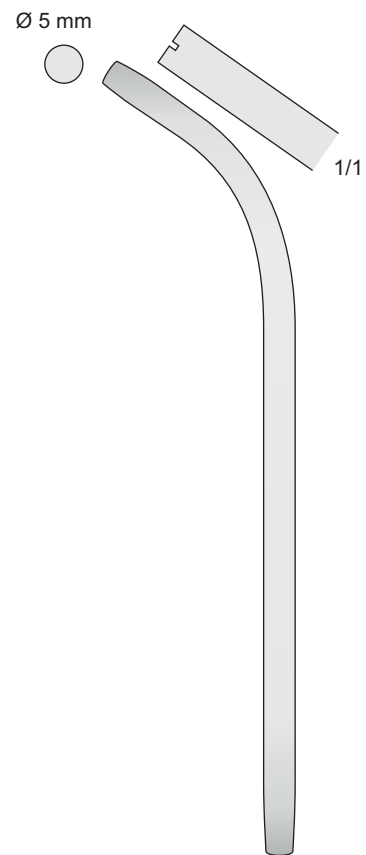
**GF-32**  
140 mm



**GF-33**  
170 mm



**GF-34**  
170 mm



**GF-35**  
170 mm



Cannule per aspirazione

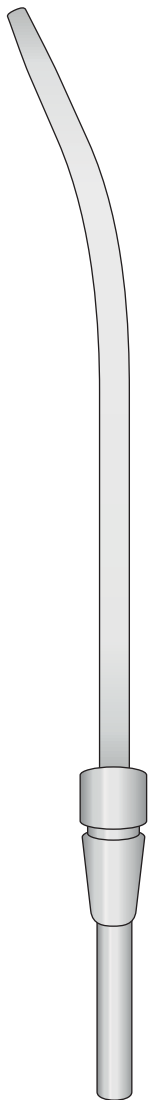
Suctions tubes

Absaugkanülen

Canules aspiratrices

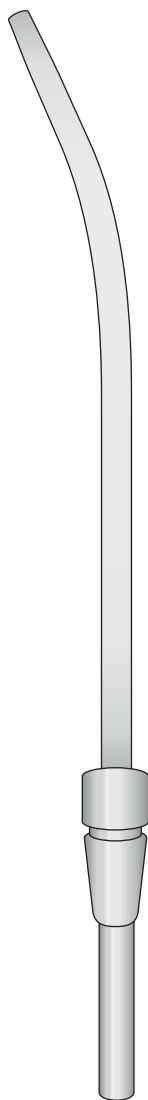
Cánulas aspiradoras

Ø 2 mm int.



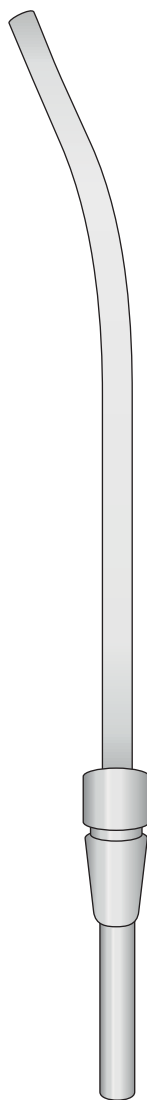
Mc KESSON  
**GF-13**  
180 mm

Ø 3 mm int.



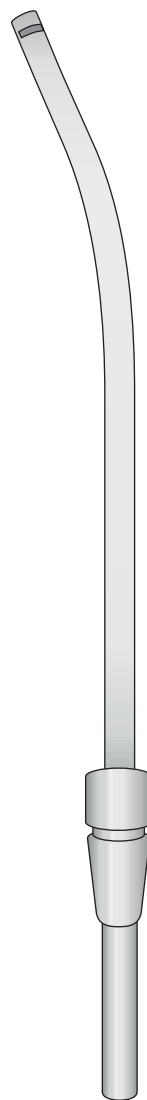
Mc KESSON  
**GF-14**  
180 mm

Ø 4 mm int.



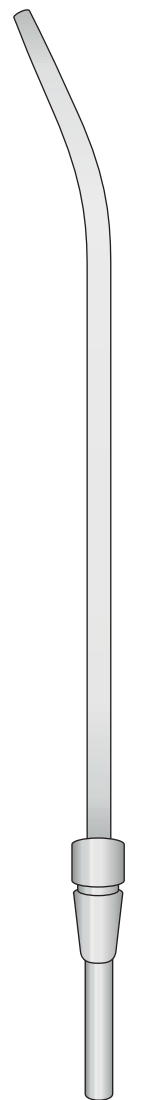
Mc KESSON  
**GF-15**  
180 mm

Ø 4 mm int.



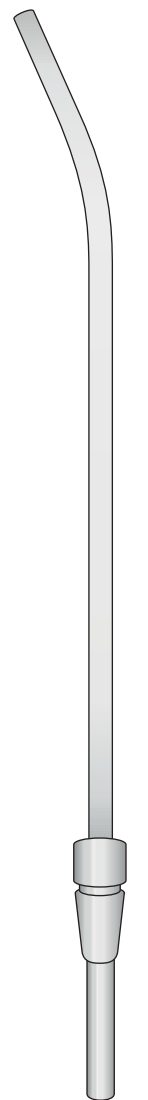
Mc KESSON  
**GF-16**  
180 mm

Ø 3 mm

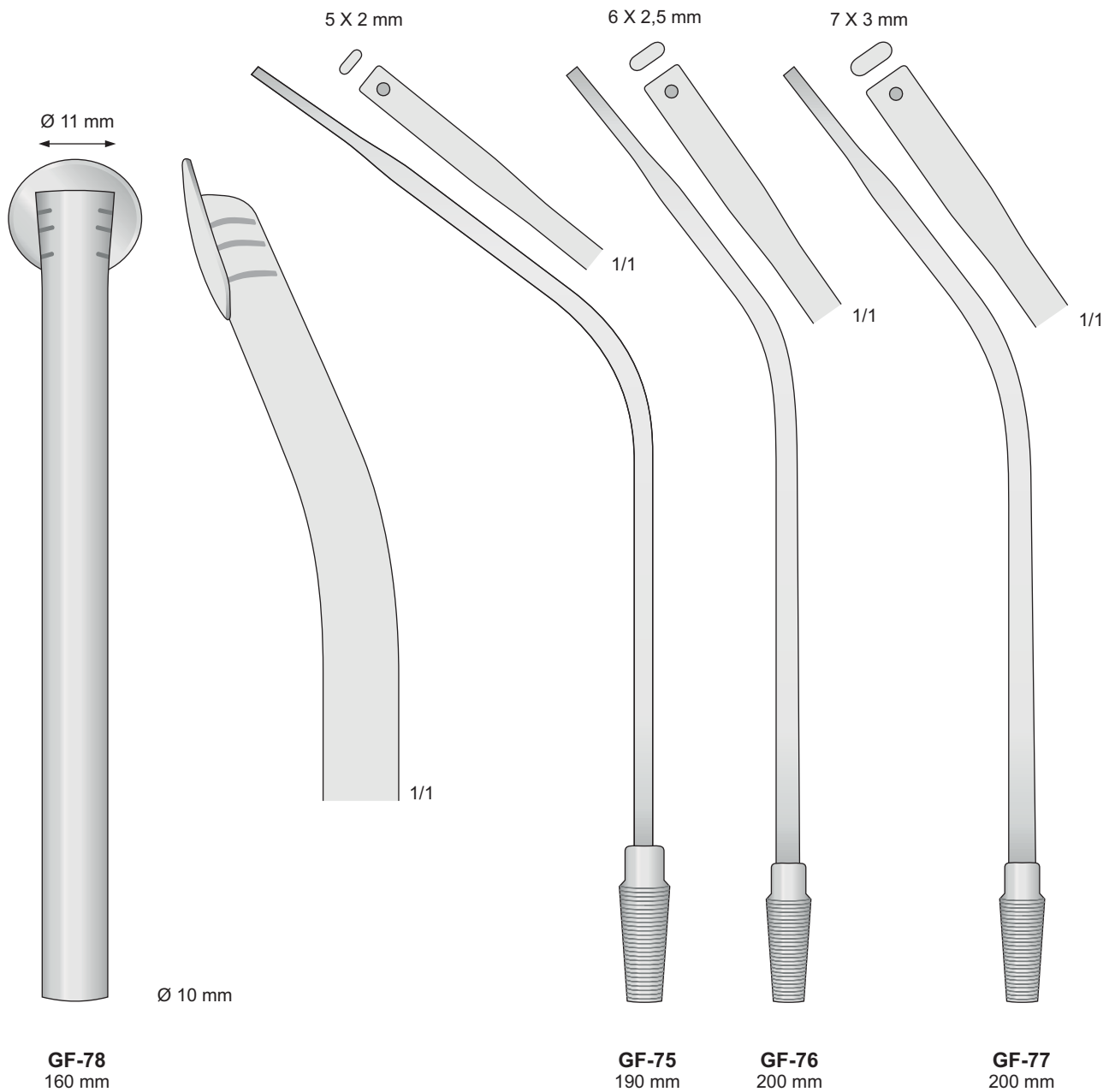


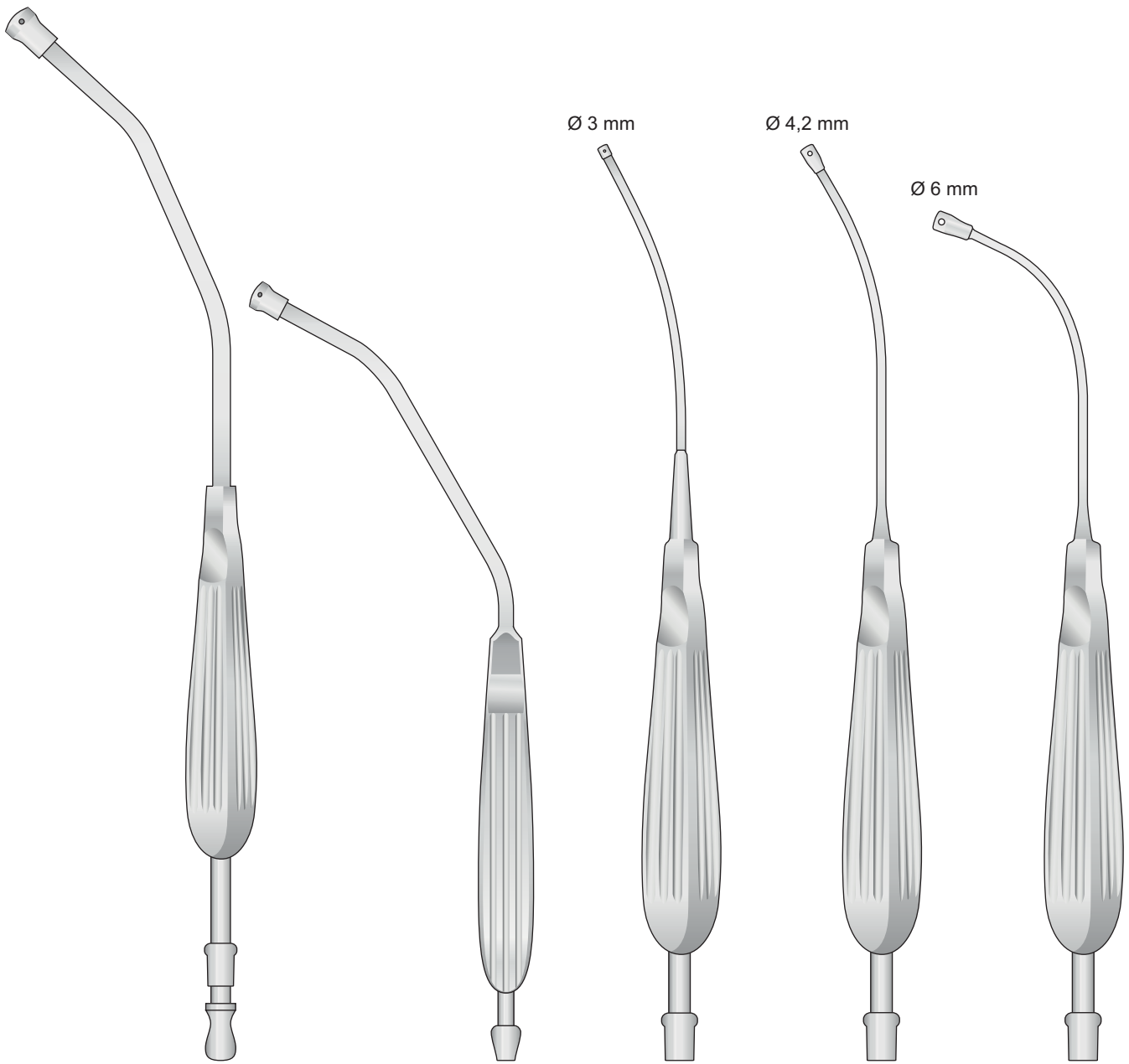
Mc KESSON  
**GF-17**  
230 mm

Ø 4 mm



Mc KESSON  
**GF-18**  
230 mm





**YANKAUER**  
**GF-12**  
310 mm

**BABY-YANKAUER**  
**GF-10**  
200 mm

**ANDREWS-PYNCHON**  
**GF-06**  
250 mm

**ANDREWS-PYNCHON**  
**GF-07**  
250 mm

**ANDREWS-PYNCHON**  
**GF-54**  
230 mm





**GF-129**

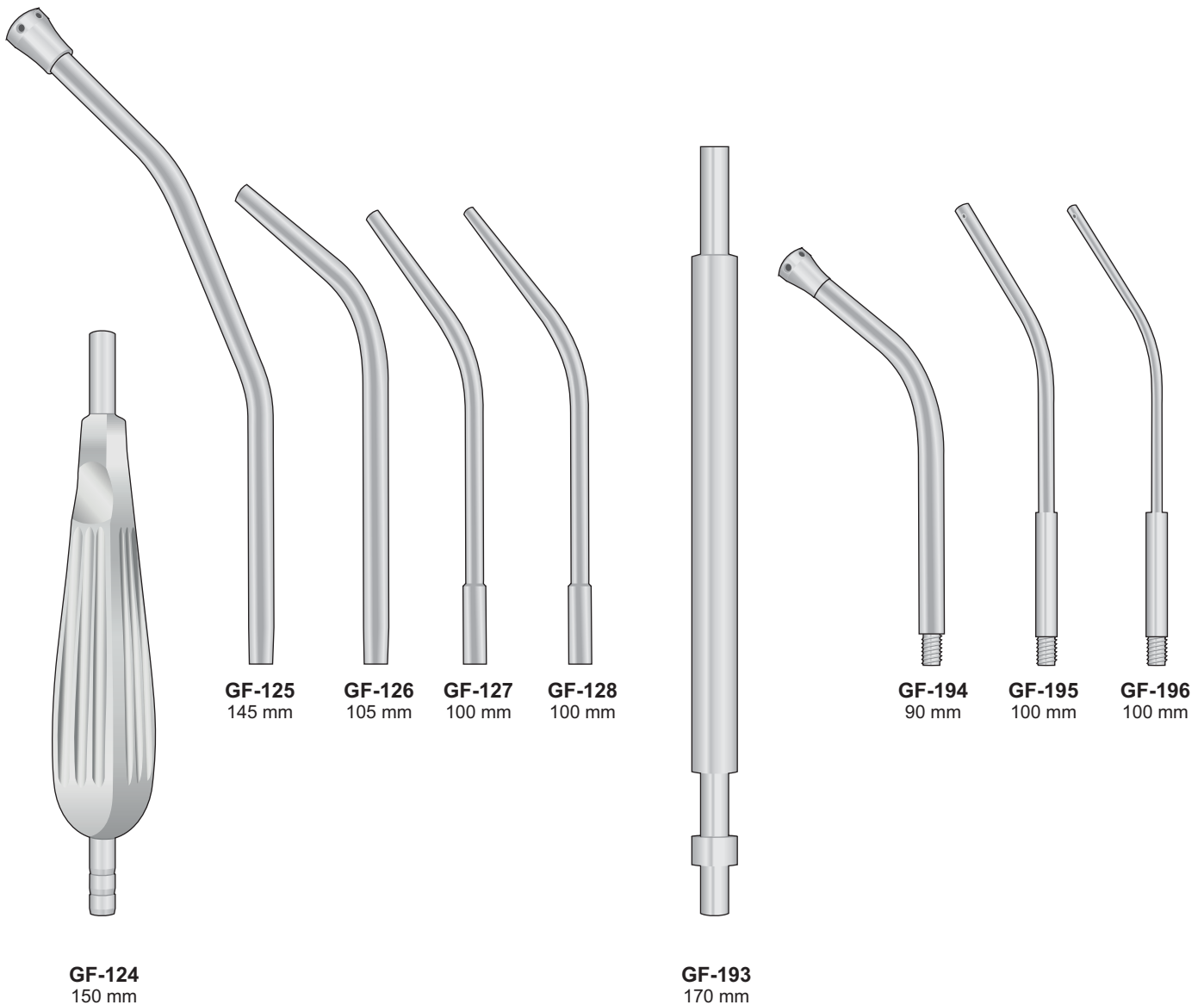
Manico portacannule  
Set - Satz - Jeu - Jeugo

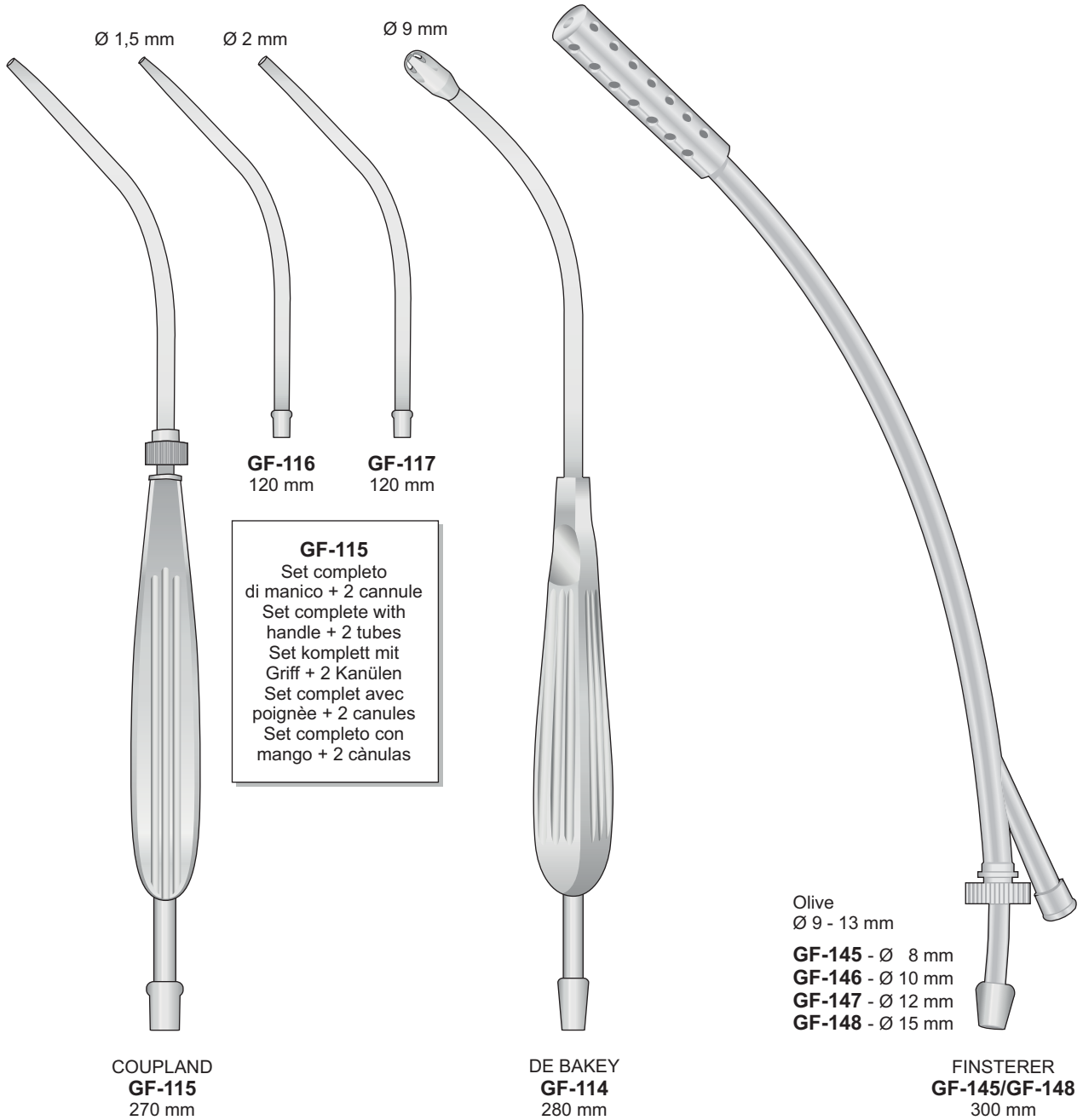
Completo con 4 cannule  
Complet with 4 tubes  
Komplett mit 4 Kanülen  
Complete avec 4 canules  
Completo con 4 cànulas

**GF-197**

Manico portacannule  
Set - Satz - Jeu - Jeugo

Completo con 3 cannule  
Complet with 3 tubes  
Komplett mit 3 Kanülen  
Complete avec 3 canules  
Completo con 3 cànulas





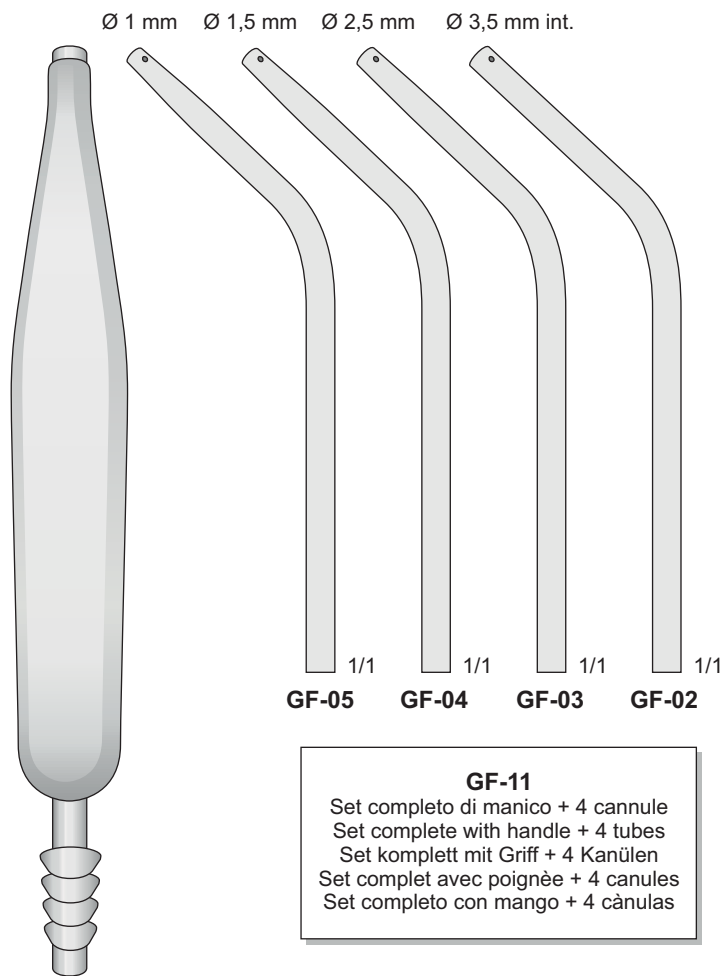
**GF-115**  
Set completo  
di manico + 2 cannule  
Set complete with  
handle + 2 tubes  
Set komplett mit  
Griff + 2 Kanülen  
Set complet avec  
poignée + 2 canules  
Set completo con  
mango + 2 cànulas

COUPLAND  
**GF-115**  
270 mm

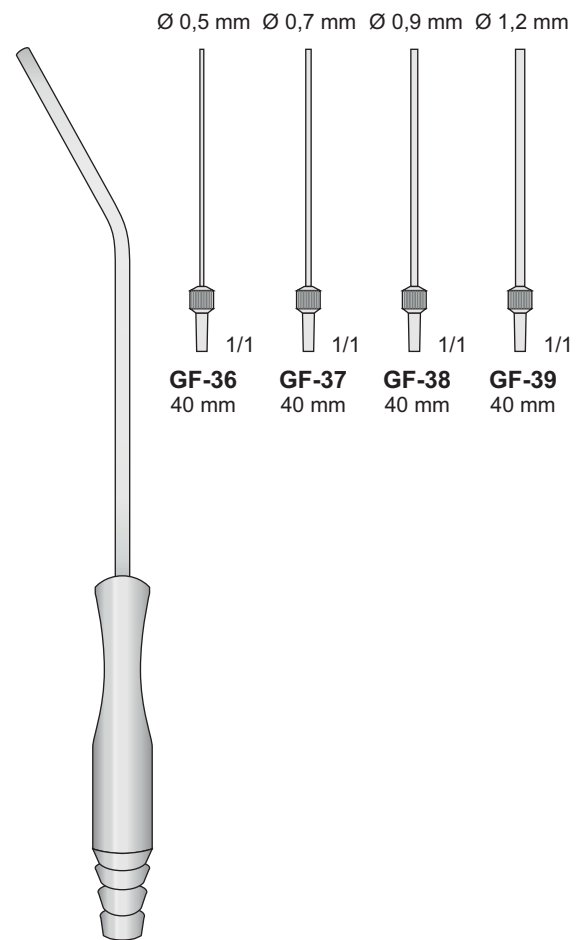
DE BAKEY  
**GF-114**  
280 mm

FINSTERER  
**GF-145/GF-148**  
300 mm

Olive  
Ø 9 - 13 mm  
**GF-145** - Ø 8 mm  
**GF-146** - Ø 10 mm  
**GF-147** - Ø 12 mm  
**GF-148** - Ø 15 mm



**GF-11**  
 Set completo di manico + 4 cannule  
 Set complete with handle + 4 tubes  
 Set komplett mit Griff + 4 Kanülen  
 Set complet avec poignée + 4 canules  
 Set completo con mango + 4 cànulas

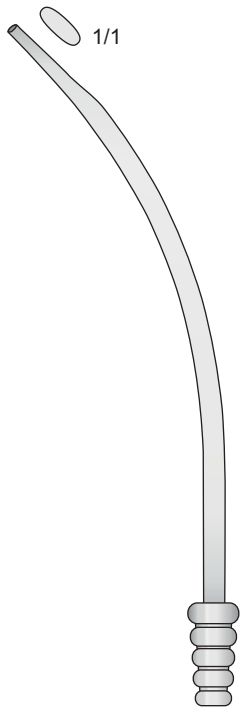


COUPLAND  
**GF-01**  
 150 mm

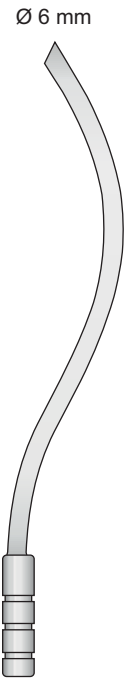
WULLSTEIN  
**GF-44**  
 140 mm



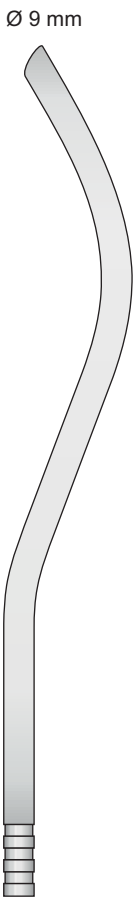
Acciaio chirurgico - Stainless steel - Rostfrei - Acier - Acero



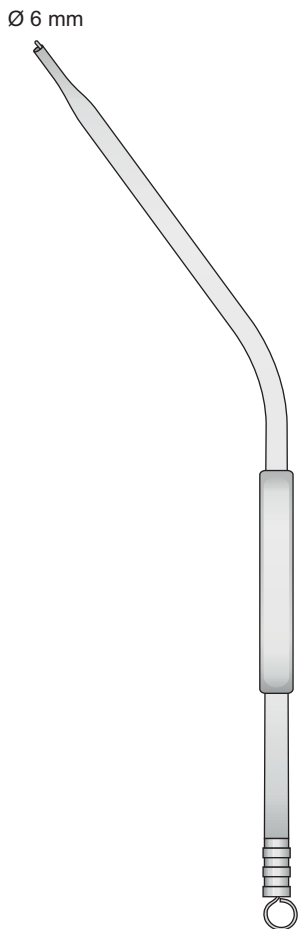
**GF-20**  
180 mm



**GF-09B**  
175 mm



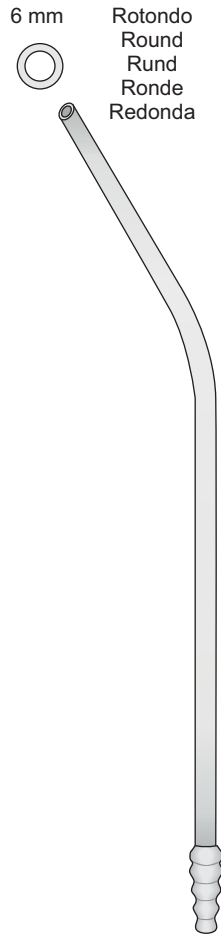
**GF-09**  
230 mm



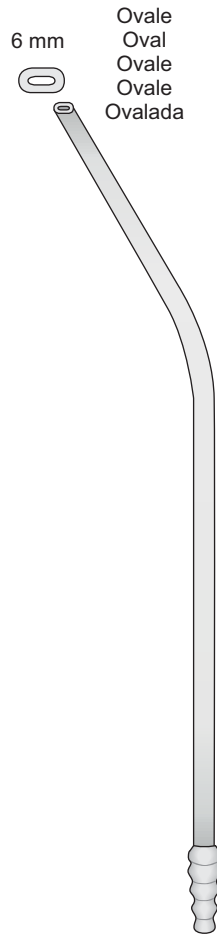
**GF-104**  
240 mm



**GF-110**  
230 mm



**NUBOER GF-98**  
210 mm



**NUBOER GF-99**  
210 mm

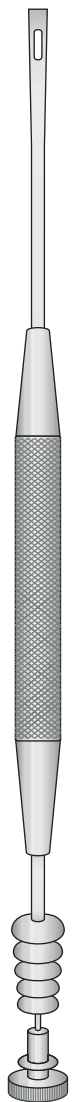
6 mm  
Rotondo  
Round  
Rund  
Ronde  
Redonda

6 mm  
Ovale  
Oval  
Ovale  
Ovale  
Ovalada

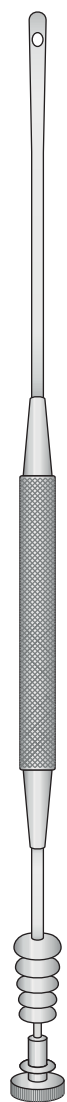


Raschietti taglienti - Raspatories, Scharp  
Saugraspatorium Scharf - Ruginne tranchante - Raspador cortante

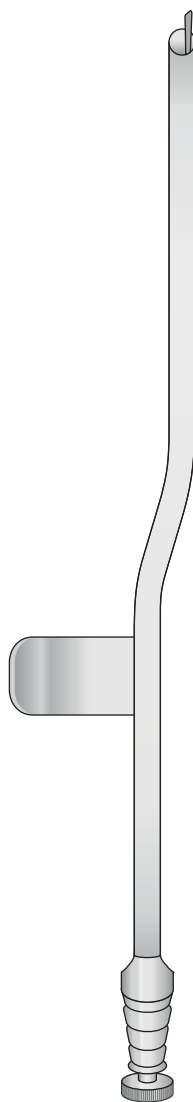
Smussa  
Blunt  
Stumpf  
Mousse  
Romo



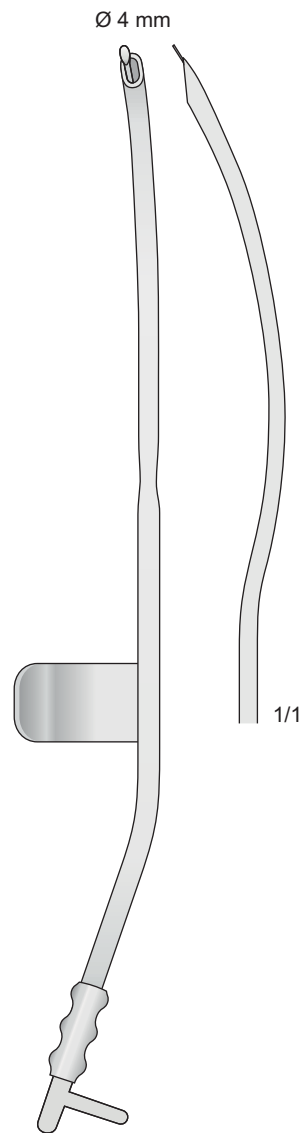
**GORNEY  
GF-71**  
180 mm



**GORNEY  
GF-72**  
200 mm



**SAUG-RASPATORIUM**  
**GF-48** Ø 4 mm  
**GF-49** Ø 5 mm  
200 mm

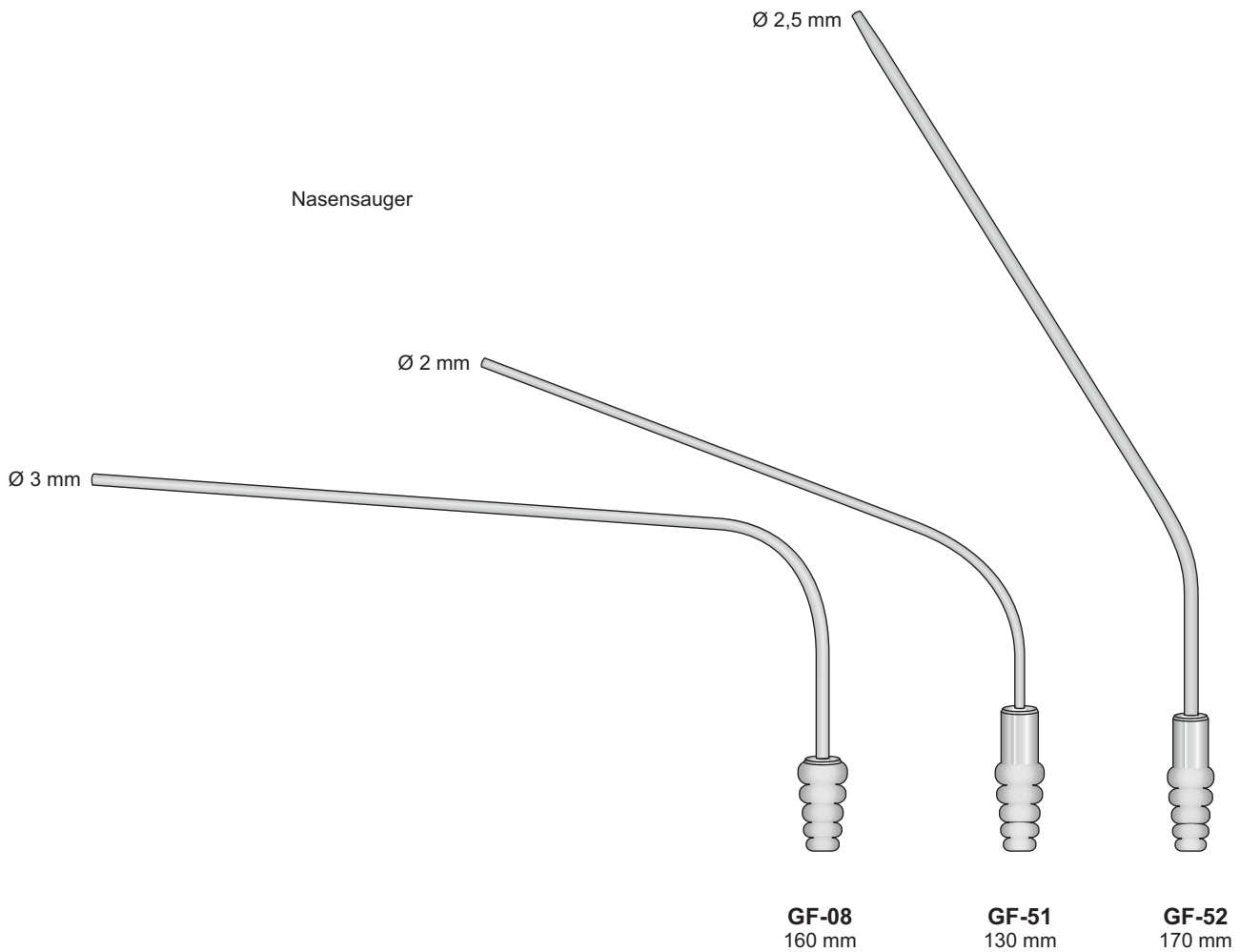


**GUILLIEN  
GF-50**  
200 mm



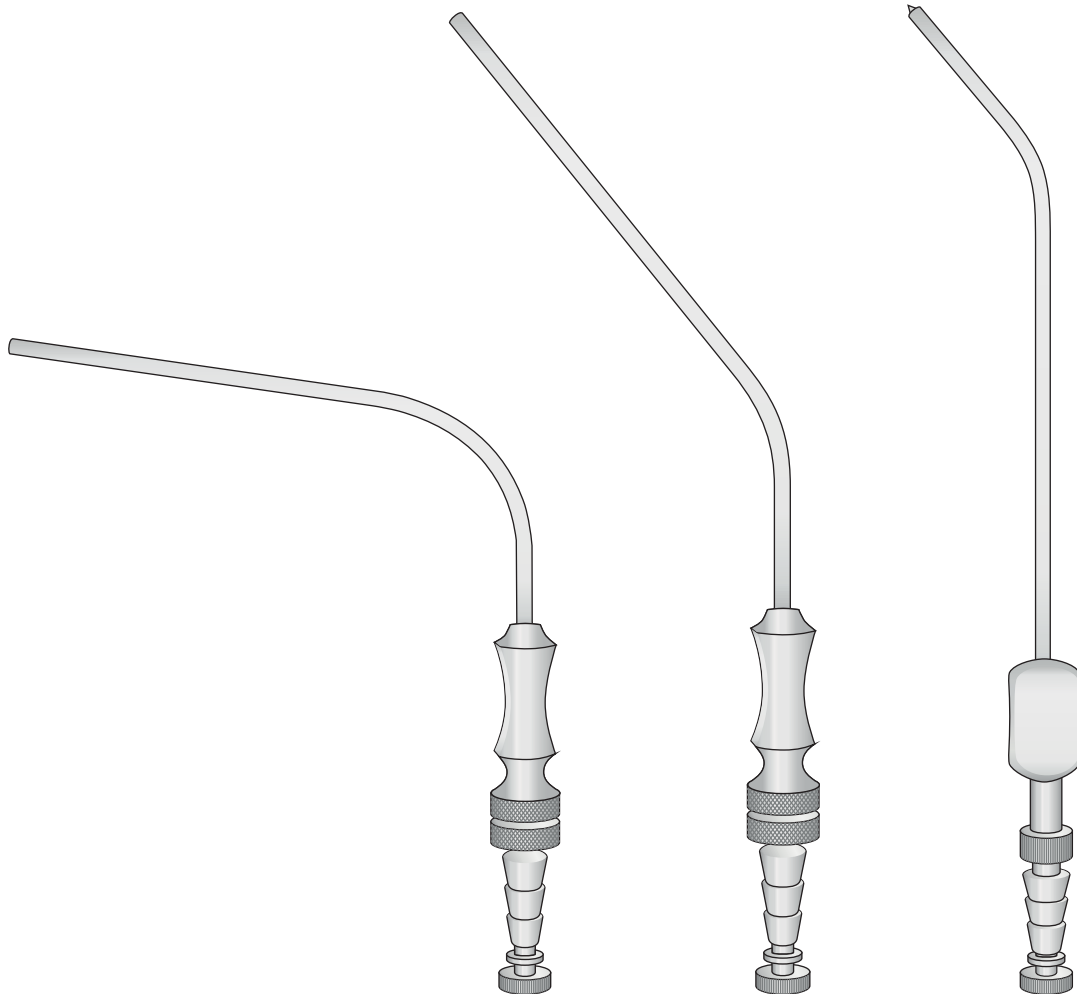
YASARGIL	Usable length	Ø								
<b>GF-210</b>	130 mm	1,5 mm								
<b>GF-211</b>	150 mm	1,5 mm								
<b>GF-212</b>	180 mm	1,5 mm								
<b>GF-213</b>	220 mm	1,5 mm								
YASARGIL	Usable length	Ø								
<b>GF-214</b>	130 mm	2,0 mm								
<b>GF-215</b>	150 mm	2,0 mm								
<b>GF-216</b>	180 mm	2,0 mm								
<b>GF-217</b>	220 mm	2,0 mm								
YASARGIL	Usable length	Ø								
<b>GF-222</b>	130 mm	2,5 mm								
<b>GF-223</b>	150 mm	2,5 mm								
<b>GF-224</b>	180 mm	2,5 mm								
<b>GF-225</b>	220 mm	2,5 mm								
YASARGIL	Usable length	Ø								
<b>GF-226</b>	130 mm	3,5 mm								
<b>GF-227</b>	150 mm	3,5 mm								
<b>GF-228</b>	180 mm </tr <tr> <td><b>GF-229</b></td> <td>220 mm</td> <td>3,5 mm</td> </tr> <tr> <td>YASARGIL</td> <td>Usable length</td> <td>Ø</td> </tr> <tr> <td><b>GF-230</b></td> <td>180 mm</td> <td>4,5 mm</td> </tr>	<b>GF-229</b>	220 mm	3,5 mm	YASARGIL	Usable length	Ø	<b>GF-230</b>	180 mm	4,5 mm
<b>GF-229</b>	220 mm	3,5 mm								
YASARGIL	Usable length	Ø								
<b>GF-230</b>	180 mm	4,5 mm								

YASARGIL  
GF-210/GF-230





Char. 6 = 2 mm  
Char 7 = 2,5 mm  
Char 9 = 3 mm  
Char 10 = 3,3 mm  
Char 12 = 4 mm  
Char 15 = 5 mm



**FERGUSSON**  
**GF-140** Ch. 6  
**GF-141** Ch. 7  
**GF-142** Ch. 9  
**GF-143** Ch. 12  
**GF-144** Ch. 15  
180 mm

**FRAZIER**  
**GF-240** Ch. 6  
**GF-241** Ch. 7  
**GF-242** Ch. 9  
**GF-243** Ch. 12  
**GF-244** Ch. 15  
180 mm

**PLESTER**  
**GF-150** Ch. 6  
**GF-151** Ch. 7  
**GF-152** Ch. 9  
**GF-153** Ch. 12  
**GF-154** Ch. 15  
200 mm



Char. 3 = 1 mm  
Char 5 = 1,7 mm  
Char 7 = 2,5 mm  
Char 10 = 3,3 mm  
Char 12 = 4 mm

Con placca d'interruzione  
With finger cut-off  
Mit Unterbrecherplatte  
Avec plaque interruptrice  
Con placa desconectadora



**BELLUCCI**  
**GF-232**  
Charr. 5

**BARON**  
**GF-43**  
Charr. 3

**BARON**  
**GF-45**  
Charr. 5

**BARON**  
**GF-47**  
Charr. 7

**BARON**  
**GF-63**  
Charr. 3

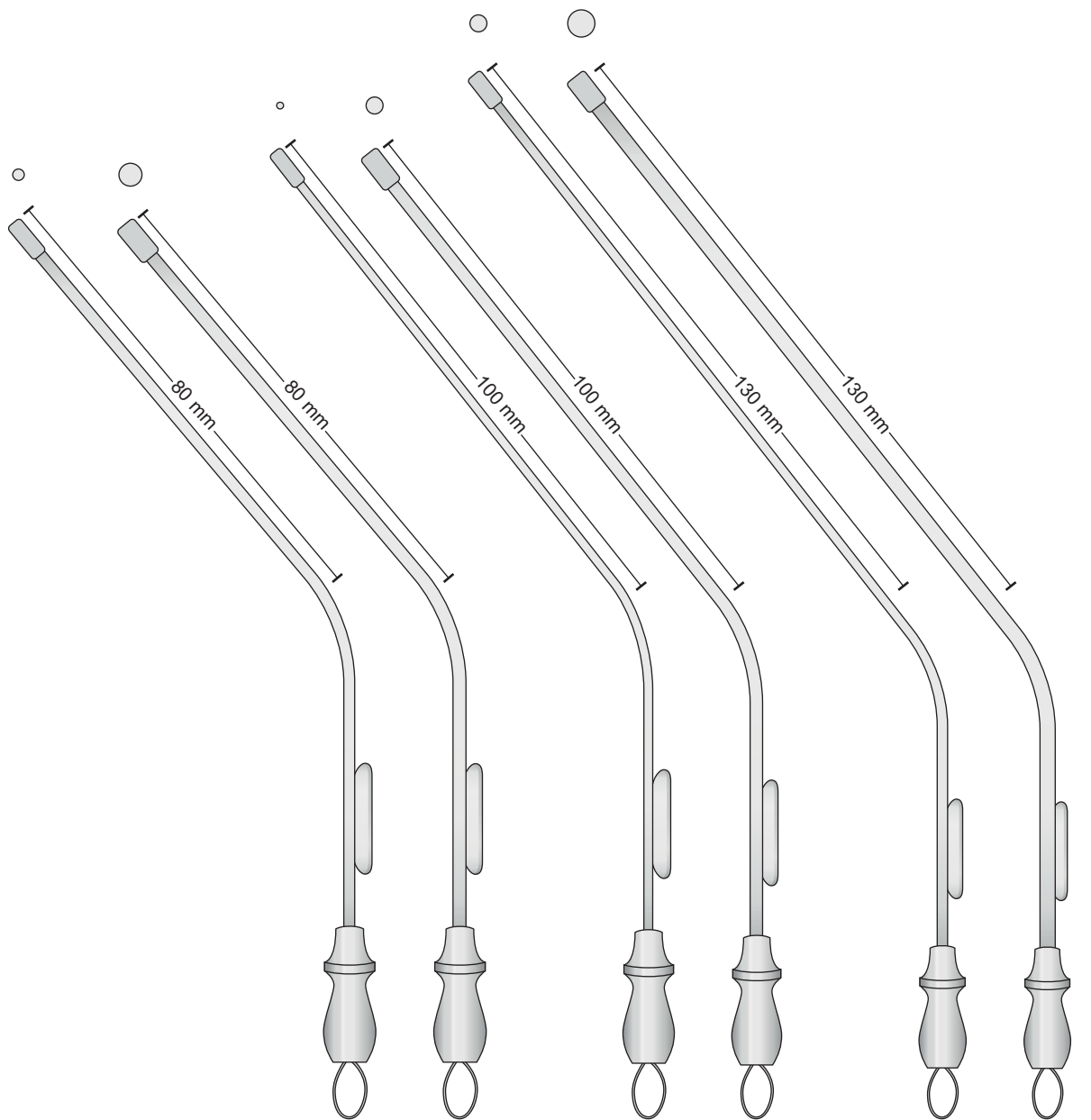
**BARON**  
**GF-65**  
Charr. 5

**BARON**  
**GF-67**  
Charr. 7





Char. 3 = 1 mm  
Char 5 = 1,7 mm  
Char 7 = 2,5 mm  
Char 10 = 3,3 mm  
Char 12 = 4 mm



ROTAN  
GF-21  
Charr. 5

ROTAN  
GF-26  
Charr. 10

ROTAN  
GF-25  
Charr. 3

ROTAN  
GF-27  
Charr. 7

ROTAN  
GF-28  
Charr. 7

ROTAN  
GF-24  
Charr. 12



House Saug- und Spülrohr, Luer Konus

Tubo per aspirazione  
Suction tube  
Saugrohr  
Tube d'aspiration

Tubo per irrigazione  
Irrigation tube  
Spülrohr  
Tube d'irrigation

Char. 3	= 1 mm
Char 5	= 1,7 mm
Char 7	= 2,5 mm
Char 10	= 3,3 mm
Char 12	= 4 mm
Char 14	= 4,6 mm

Char. 2	= 0,6 mm
Char 4	= 1,21 mm
Char 5	= 1,7 mm
Char 7	= 2,5 mm
Char 8	= 2,4 mm
Char 12	= 4 mm



HOUSE  
GF-53  
Charr. 3/2

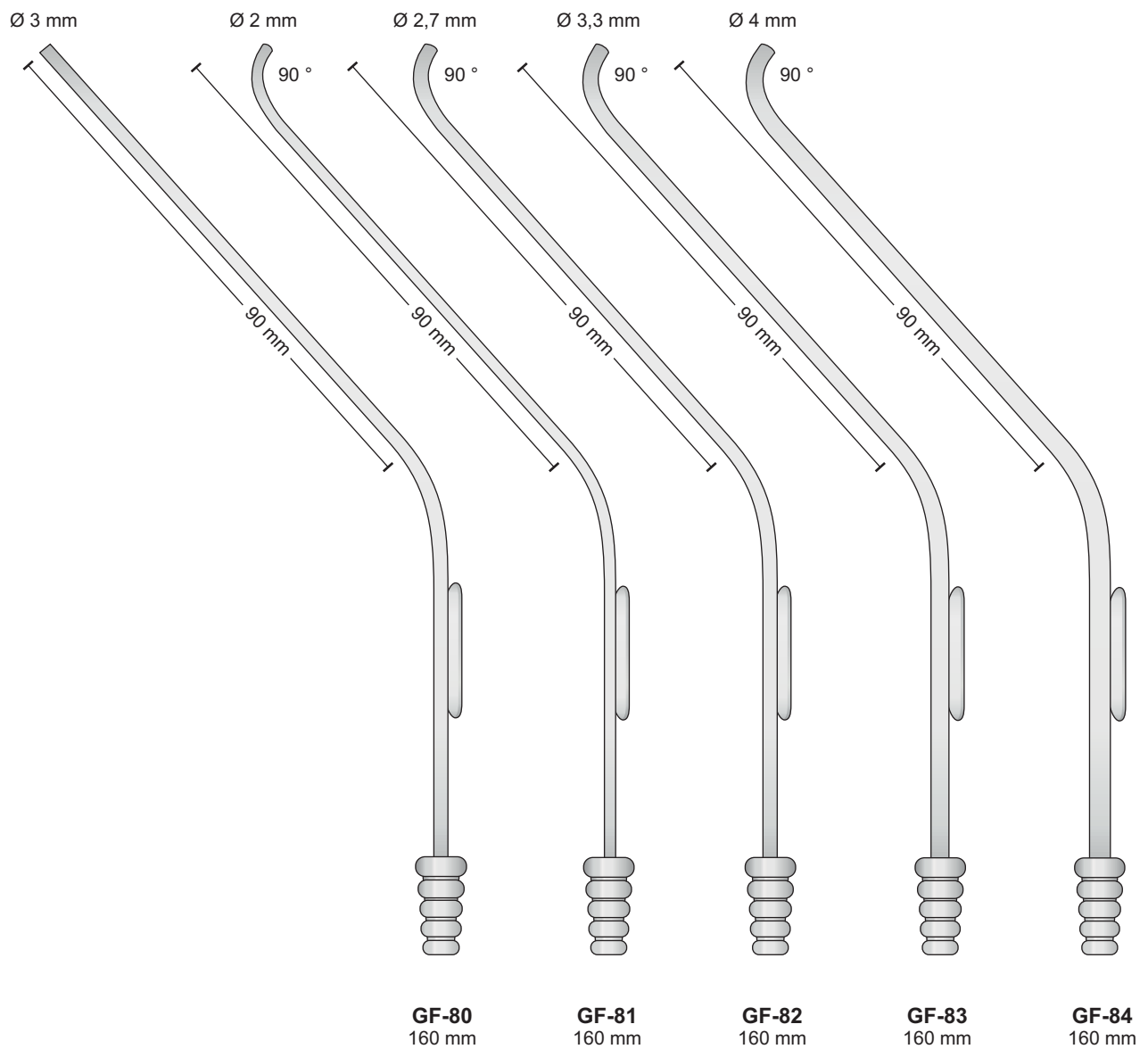
HOUSE  
GF-55  
Charr. 5/4

HOUSE  
GF-57  
Charr. 7/5

HOUSE  
GF-56  
Charr. 10/7

HOUSE  
GF-59  
Charr. 12/8

HOUSE  
GF-58  
Charr. 14/12





Superficie colorata nera  
Surface Black-finish  
Oberfläche Geschwärzt  
Surface noircie

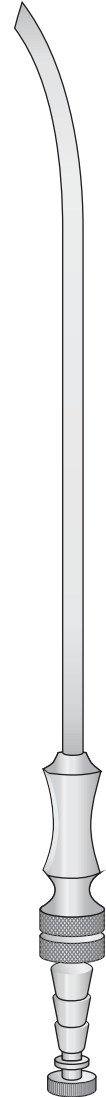
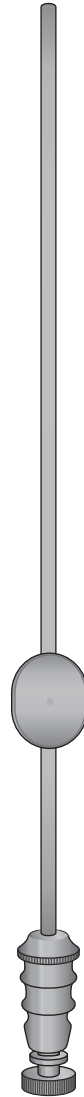
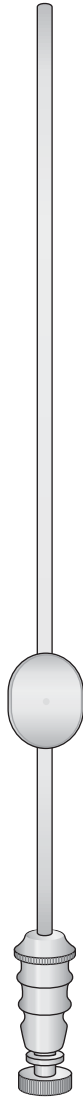
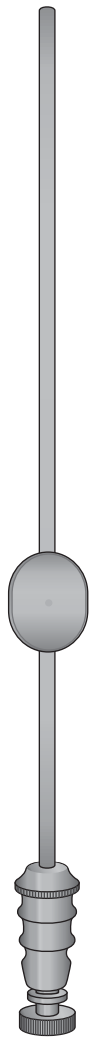
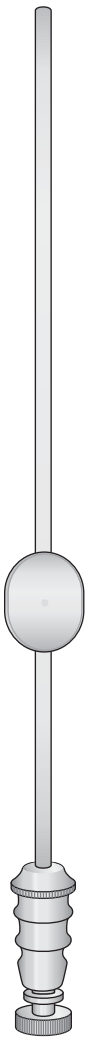
Superficie colorata nera  
Surface Black-finish  
Oberfläche Geschwärzt  
Surface noircie

Malleabile  
Malleable  
Biegsam  
Malléables  
Malleable  
Ø 3 mm

Malleabile  
Malleable  
Biegsam  
Malléables  
Malleable  
Ø 3 mm

Malleabile  
Malleable  
Biegsam  
Malléables  
Malleable  
Ø 3 mm

Malleabile  
Malleable  
Biegsam  
Malléables  
Malleable  
Ø 3 mm



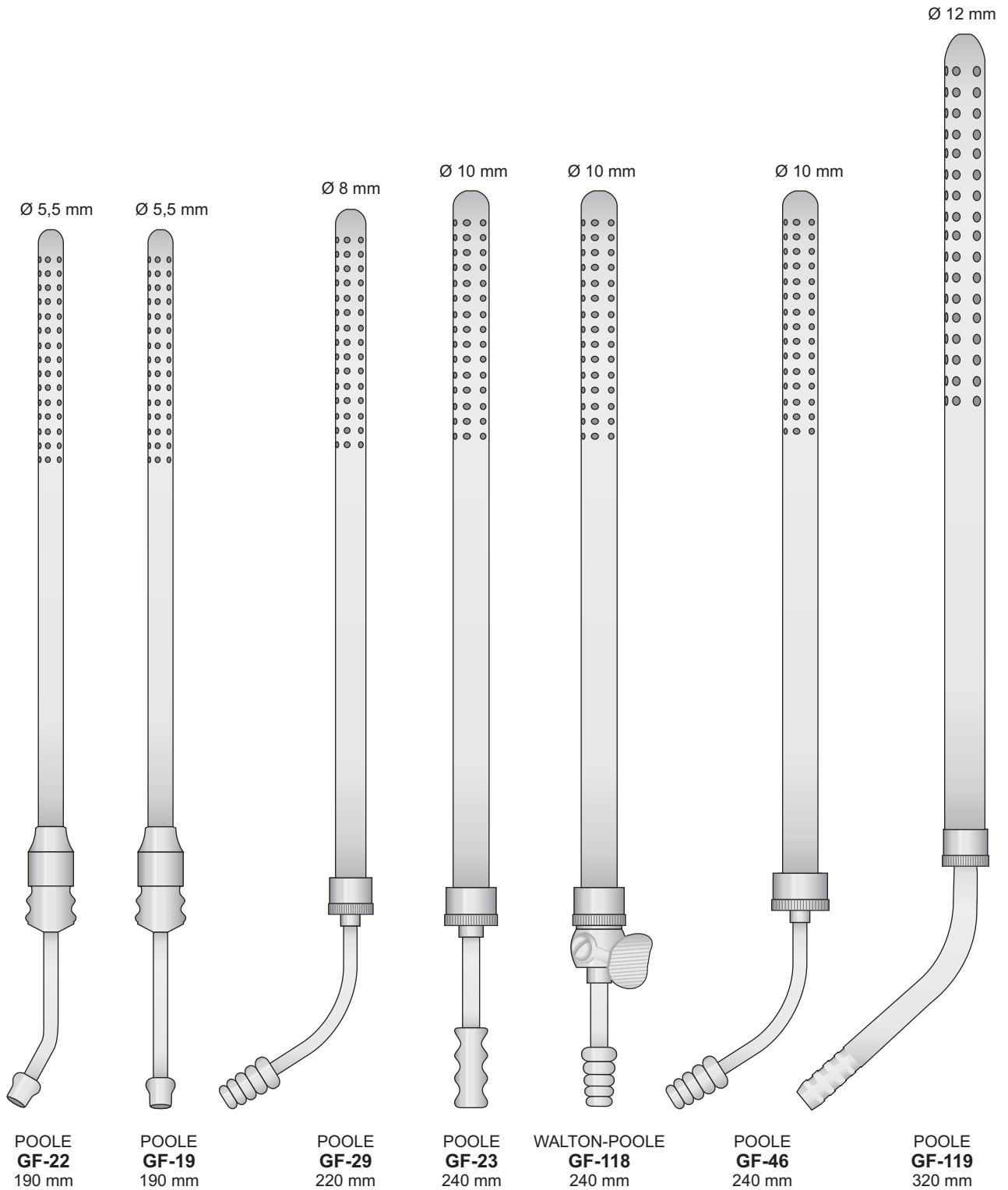
WERTHEIMER  
**GF-69**  
160 mm

FRAZIER  
**GF-70**  
160 mm

WERTHEIMER  
**GF-60**  
200 mm

FRAZIER  
**GF-61**  
200 mm

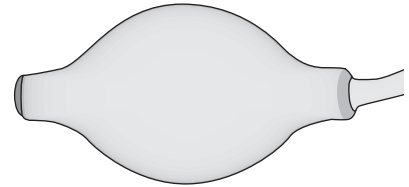
ADSON  
**GF-41** ch. 12 = Ø 4 mm  
**GF-42** ch. 15 = Ø 5 mm  
210 mm





**GF-97**  
 Set completo con:  
 Set complete with:  
 Komplettsset mit:  
 Set complet avec:  
 Set completos con:  
**GF-92 - GF-93 - GF-94 - GF-96**

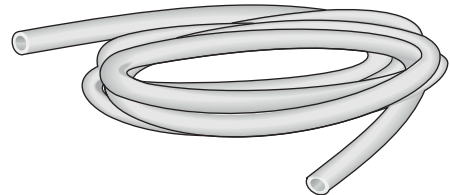
Pompetta in gomma - Rubber bulb  
 Gummiball - Poire en caoutchouc  
 Pera de goma



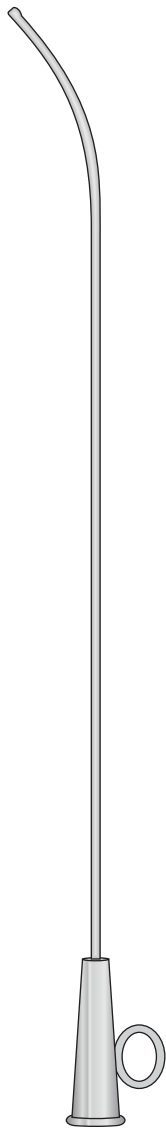
**GF-96**

Raccordo in silicone per cannule  
 Autoclavabile  
 Flexible tube - Silicone  
 Schlauch - Silikon  
 Tuyau - Silicone  
 Tubo flexible de silicona

2 mt.



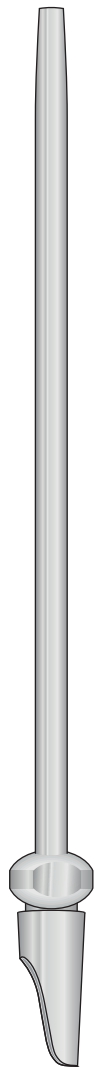
**TS-50**  
2 mt.



**GF-111** - Ø 1,5 mm  
**GF-112** - Ø 2 mm  
**GF-113** - Ø 2,5 mm

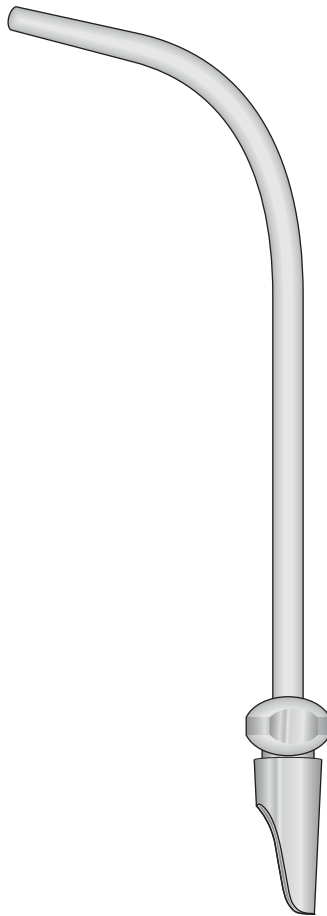
**HARTMANN**  
**GF-111/GF-113**  
170 mm

Ø 4 mm

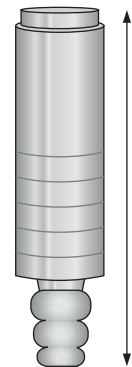


**GF-94**  
160 mm

Ø 4 mm



**GF-93**  
145 mm

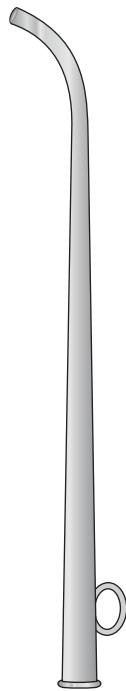


65 mm

**GF-92**  
65 mm

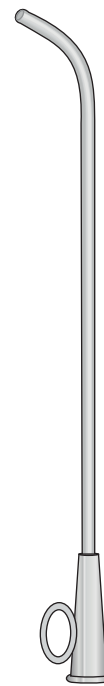


Sonde auricolari  
Ear Catheters  
Ohrkatheter  
Sondes auriculaires  
Sondas auriculares



ITARD  
GF-156/GF-160  
145 mm

- GF-156 Ø 3,0 mm
- GF-157 Ø 3,5 mm
- GF-158 Ø 4,0 mm
- GF-159 Ø 4,5 mm
- GF-160 Ø 5,0 mm



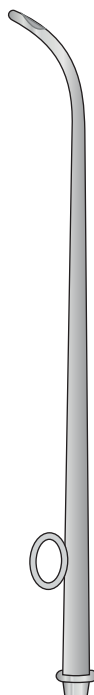
HARTMANN  
GF-161/GF-167  
150 mm

- GF-161 Ø 2,0 mm
- GF-162 Ø 2,5 mm
- GF-163 Ø 3,0 mm
- GF-164 Ø 3,5 mm
- GF-165 Ø 4,0 mm
- GF-166 Ø 4,5 mm
- GF-167 Ø 5,0 mm



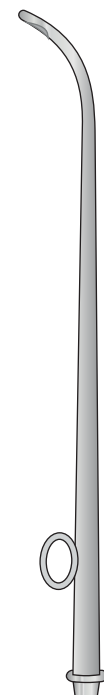
GF-168

Cannule per lavaggio dei seni frontali e mascellari  
Antrum and frontal sinus wash cannulas  
Kiefer und Stirnhöhlen-Spülkanülen  
Canules pour le lavage du sinus maxillaire et frontal  
Cánulas lavadores para seno maxilar y seno frontal



SIEBENMANN  
GF-169/GF-173  
150 mm

- GF-169 Ø 1,5 mm
- GF-170 Ø 1,7 mm
- GF-171 Ø 2,0 mm
- GF-172 Ø 2,5 mm
- GF-173 Ø 3,0 mm



SIEBENMANN  
GF-174/GF-178  
150 mm

- GF-174 Ø 1,5 mm
- GF-175 Ø 1,7 mm
- GF-176 Ø 2,0 mm
- GF-177 Ø 2,5 mm
- GF-178 Ø 3,0 mm



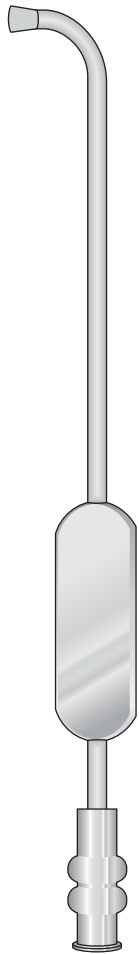
GF-179



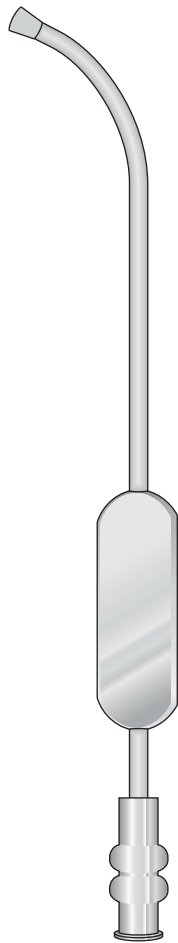
Cannule per lavaggio dei seni frontali e mascellari  
 Antrum and frontal sinus wash cannulas  
 Kiefer und Stirnhöhlen-Spülkanülen  
 Canules pour le lavage du sinus maxillaire et frontal  
 Cánulas lavadores para seno maxilar y seno frontal

Ø Interno  
 Ø Inside  
 Ø Innen  
 Ø Intérieur  
 Ø Interior

Ø Interno  
 Ø Inside  
 Ø Innen  
 Ø Intérieur  
 Ø Interior



KILLIAN  
**GF-85** Ø 3 mm  
**GF-87** Ø 4 mm  
 145 mm



KILLIAN  
**GF-86** Ø 3 mm  
**GF-88** Ø 4 mm  
 145 mm



MAGILL  
**GF-100** Ø 1 mm  
 200 mm



MAGILL  
**GF-101** Ø 1 mm  
**GF-102** Ø 2 mm  
**GF-103** Ø 3 mm  
 200 mm





Cannule per aspirazione

Suctions tubes

Absaugkanülen

Canules aspiratrices

Cànulas aspiradoras

Scovolini per pulizia cannule - Cleaning brush for tubes  
Kanülenreinigungs-bürsten - Brosse de nettoyage pour canules  
Cepillo para limpiar cánulas

Autoclavabile  
Autoclavable  
Steriliser bar  
Stérilisable  
Esterilizable

Spazzola per unghie  
Nail brushes  
Handwaschbürste  
Brosse à ongles  
Cepillos de uñas



**GF-200**  
4 x 11 cm

Ø Est. 8 mm  
Ø Int. 6 mm

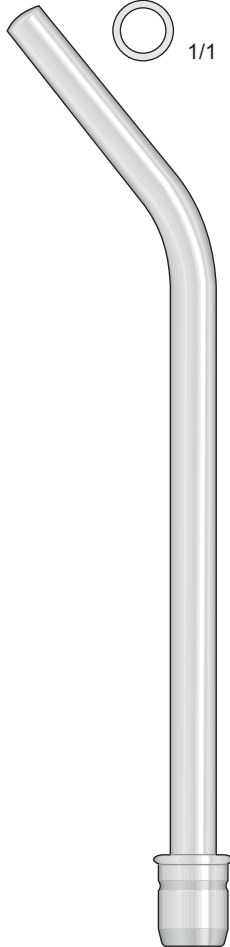


1/1

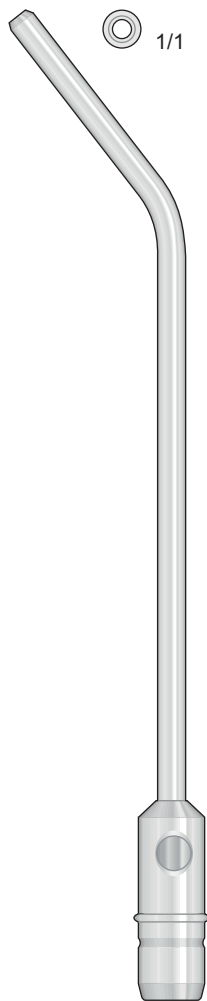
Ø Est. 5 mm  
Ø Int. 2,5 mm



1/1



PELTON-CRANE  
**GF-184**  
140 mm



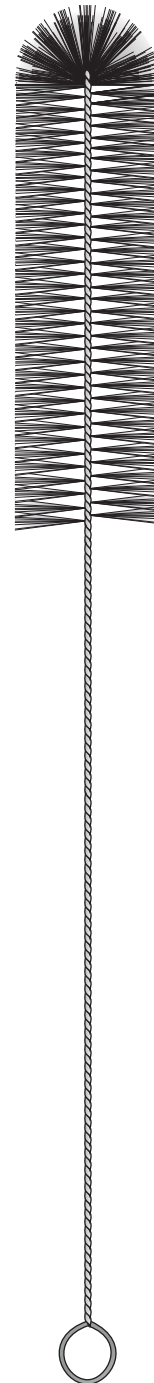
PELTON-CRANE  
**GF-180**  
160 mm



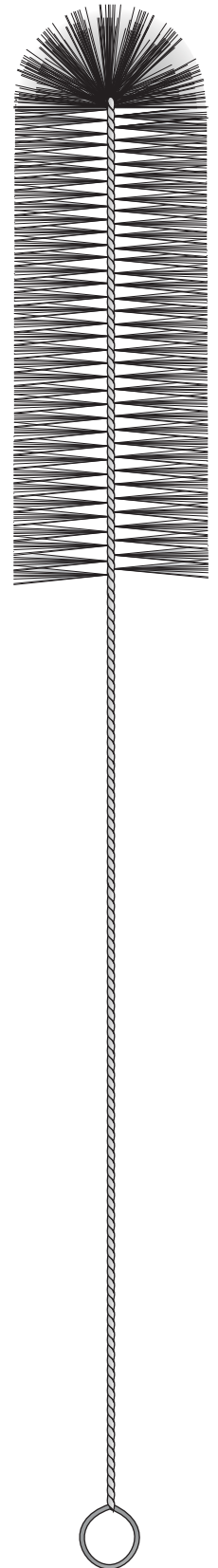
**GF-40**  
235 mm



**GF-188**  
220 mm



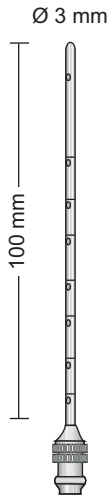
**GF-187**  
300 mm



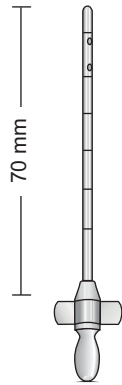
**GF-189**  
360 mm



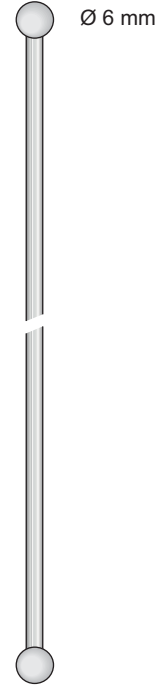
Sonde per varici, malleabili - Probe for varicose veins, malleable  
Krampfadersonden, biegsam - Sondes pour varices, malléables  
Sondas para vârices, maleables



FRAZIER  
GF-190



GF-191 - Ø 2 mm  
GF-192 - Ø 2,5 mm

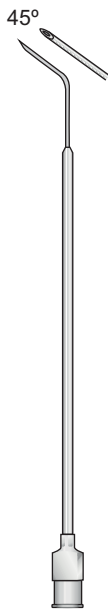


BABCOCK  
OL-66 - 400 mm  
OL-67 - 500 mm  
OL-68 - 650 mm  
OL-69 - 800 mm

Aghi per tonsille  
Tonsil needles  
Tonsillenkanülen  
Aiguilles pour les amygdales  
Agujas para amígdalas



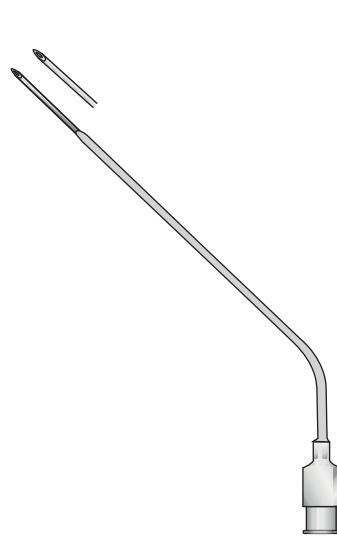
OL-01  
120 mm



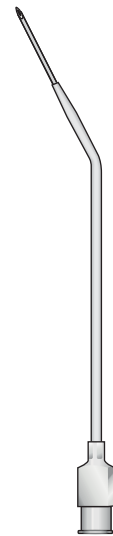
OL-02  
110 mm



OL-03  
110 mm



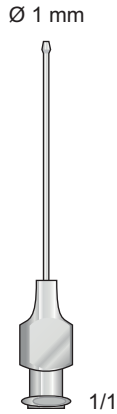
SEPTUN-NADEL  
OL-04  
110 mm



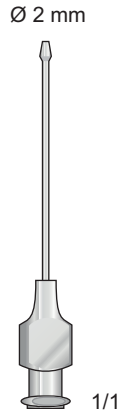
OL-05  
110 mm



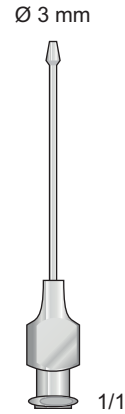
Strumenti per aspirazione e lavaggio  
Aspirating and Irrigating instruments  
Saug- und Spülinstrumente  
Instruments à aspiration et à irrigation  
Instrumentos de aspiración y de lavado



**OL-22**  
50 mm



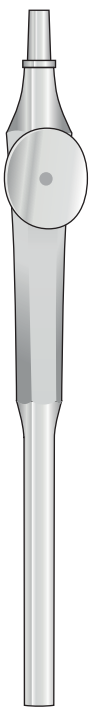
**OL-23**  
50 mm



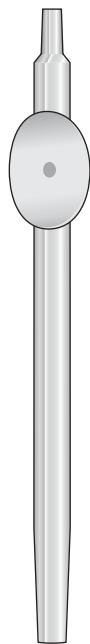
**OL-24**  
50 mm

WULLSTEIN manico per aspirazione e lavaggio, con cono Luer, per cannule per aspirazione e lavaggio di WULLSTEIN  
WULLSTEIN Irrigating suction handle, with Luer cone, for WULLSTEIN irrigating or Suction tubes  
WULLSTEIN Spül- und Saughandgriff mit Luer-Konus, passend für WULLSTEIN Spül- oder Saugrohre  
WULLSTEIN manche aspirateur et irrigateur, à cône Luer, s'adaptant aux tubes aspirateurs/irrigateurs de WULLSTEIN  
WULLSTEIN mango irrigador y ispirador, con cono Luer, apropiado para los tubos de lavado y de aspiración según WULLSTEIN

Cannule per irrigazione dei vasi, malleabili  
Vessel irrigating cannulas, malleable  
Gefäß-spülkanülen, biegsam  
Canules d'irrigation pour vaisseaux, malléables  
Cànulas de irrigacion para vasos, maleables



WULLSTEIN  
**GF-64**  
120 mm



**GF-66**  
110 mm



**GF-62**  
65 mm

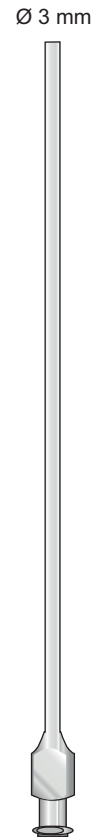
Con cono LUER-LOCK  
With LUER-LOCK attachment  
Mit LUER-LOCK-Ansatz  
Avec cône LUER-LOCK  
Con cono LUER-LOCK



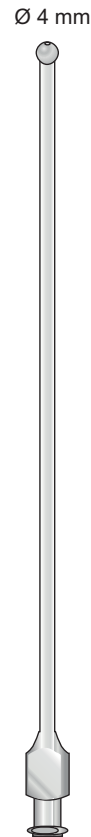
ROSEN  
**OL-16** Ø 0,70 mm  
**OL-17** Ø 0,90 mm  
**OL-18** Ø 1,25 mm  
95 mm



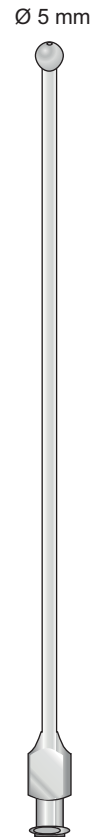
ROSEN  
**OL-13** Ø 0,70 mm  
**OL-14** Ø 0,90 mm  
**OL-15** Ø 1,25 mm  
95 mm



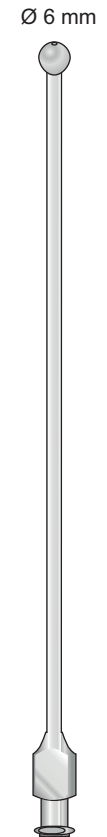
SCHMID  
**OL-30**  
150 mm



SCHMID  
**OL-31**  
150 mm



SCHMID  
**OL-32**  
150 mm



SCHMID  
**OL-33**  
150 mm



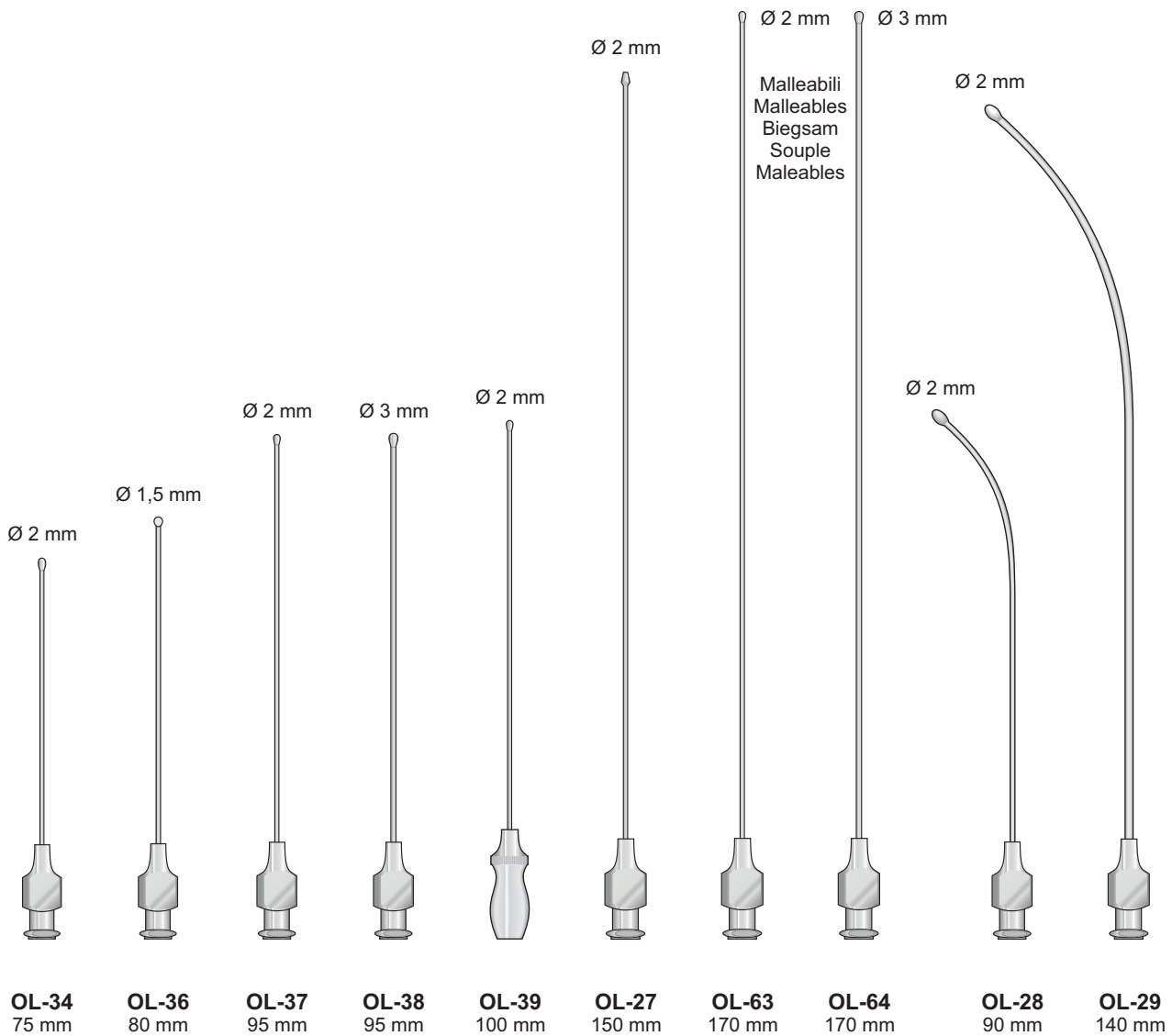
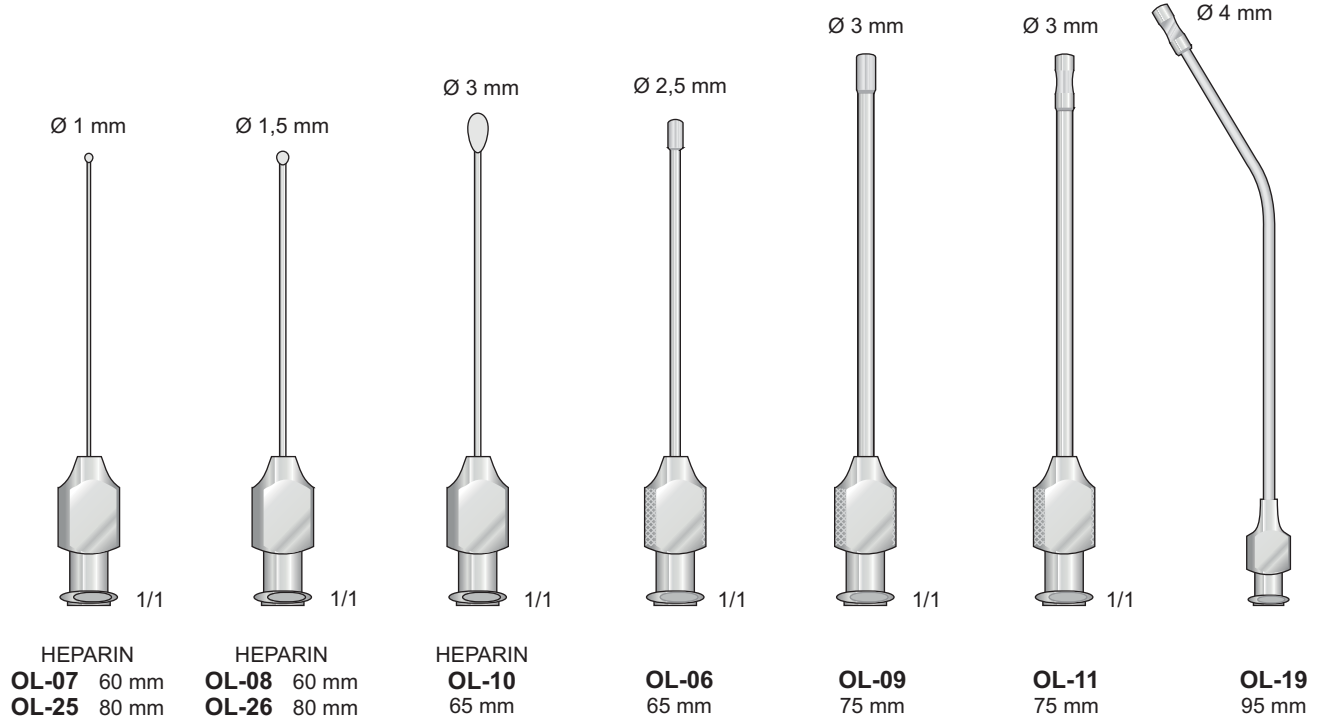
Cannule per aspirazione

Suctions tubes

Absaugkanülen

Canules aspiratrices

Cánulas aspiradoras





Cannule per aspirazione

Suctions tubes

Absaugkanülen

Canules aspiratrices

Cànulas aspiradoras

Aghi malleabili

0,5 mm



**OL-86**  
150 mm

0,7 mm



**OL-87**  
150 mm

1 mm



**OL-88**  
150 mm

1,5 mm



**OL-89**  
150 mm

2 mm



**OL-90**  
150 mm

2,5 mm



**OL-91**  
150 mm

3 mm



**OL-92**  
150 mm

Aghi malleabili con due fori

0,5 mm



**OL-93**  
150 mm

0,7 mm



**OL-94**  
150 mm

1 mm



**OL-95**  
150 mm

1,5 mm



**OL-96**  
150 mm

2 mm



**OL-97**  
150 mm

2,5 mm

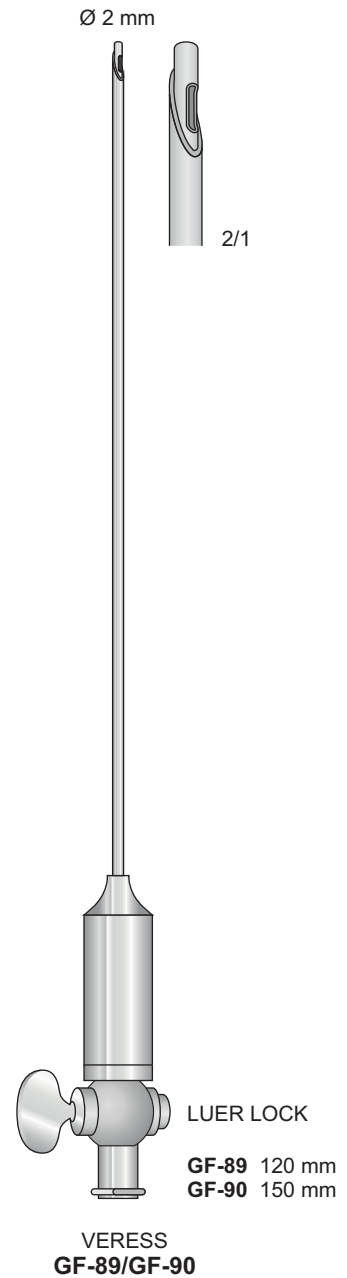
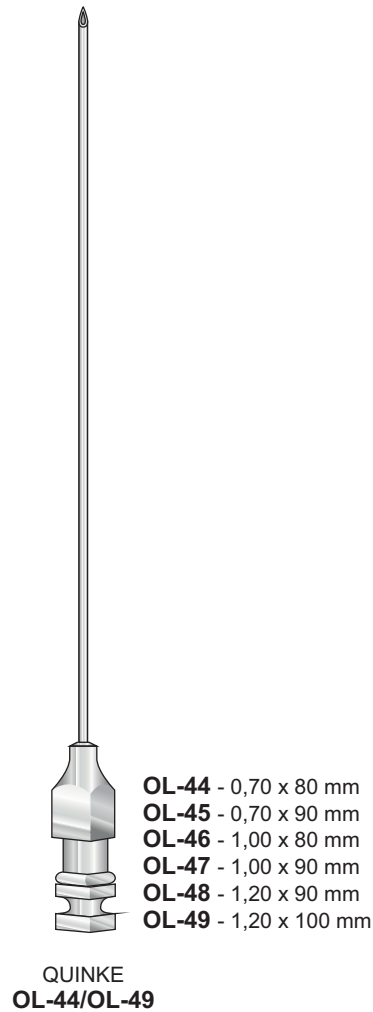
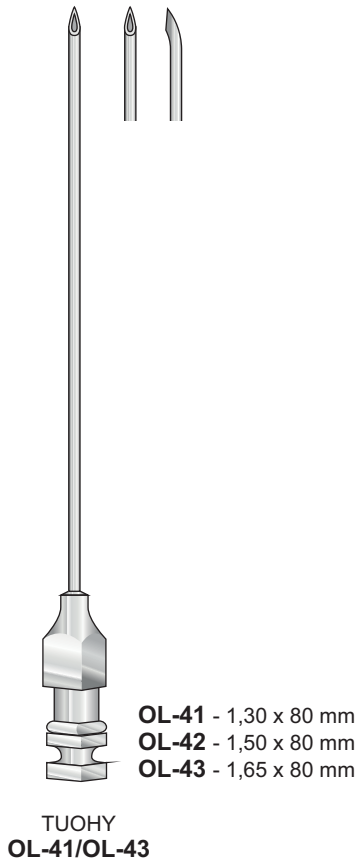


**OL-98**  
150 mm

3 mm



**OL-99**  
150 mm





18

Mantenimento strumenti  
Maintaining of instruments  
Erhaltung für instrumente  
Nettoyage d'instruments  
Mantenimiento del instrumental







### RODHOIL

Lubrificante ad alta densità. Assicura la perfetta funzionalità e scorrevolezza di tutti gli strumenti chirurgici. Da applicare negli snodi, giunture e in tutte le parti in movimento soggette ad attrito.

### RODHOIL

Lubricant to high density. It assures the perfect utility and fluency of all the surgical instruments. For apply in to loosens, join and in all the parts in subject movement subject to attrition.

### RODHOIL

Schmiermittel mit hoher Dichte. Es sichert den perfekten Gebrauch und die Leichtgängigkeit aller chirurgischen Instrumente. Man gibt es auf die Verbindungen und Gelenke und in alle Beweglichen Teile, die Reibungen unterworfen sind.

Olio lubrificante per  
strumenti chirurgici



DB-OLR  
50 cc

### CLEANLACT

Prodotto concentrato per strumenti chirurgici. Esplica un azione anticorrosiva batteriostatica e lubrificante. Garantisce il perfetto mantenimento di tutti gli strumenti in acciaio eliminando eventuali macchie, aloni e bruniture dovute a sterilizzazioni, disinfezioni e a lavaggi con acque dure. Va usato periodicamente.

### CLEANLACT

Product concentrated for surgical instruments. It explains an action anti-corrosive, antibacterium and lubricant. It guarantees the perfect maintenance of all the instruments in steel eliminating eventual stains and burnishes to sterilization, disinfection and to washings with hard waters. It used periodically.

### CLEANLACT

Reinigungskonzentrat für chirurgische Instrumente. Es wirkt antibakteriell, nicht-ätzend und schmierig. Es garantiert die perfekte Erhaltung aller Instrumente aus Stahl, entfernt eventuelle Flecken, Ränder, und Bräunungen von Sterilisationen, Desinfektionen und Reinigungen mit hartem wasser. Es sollte regelmäßig verwendet werden.

Lubrificante anticorrosivo e detergente per strumenti chirurgici  
Soluble lubricant extends useful life of surgical instruments  
Das wasserlösliche Schmiermittel verlängert die lebensdauer von chirurgischen instrumenten  
Lubrifiant soluble dans l'eau prolonge la vie des instruments chirurgicaux  
Lubrificante soluble en agua,  
so uso prolunga la duracion de los instrumentos quirurgicos



DB-1L - 1000 cc  
DB-5L - 5000 cc



Pietre di Arkansas per affilatura strumenti  
Sharpening stones  
Schleifsteine  
Pierres d'affutage  
Materiales para afilar

Olio per affilatura strumenti  
Oil for grinding stones  
Schleifstein-Öl  
Huile d'affutage



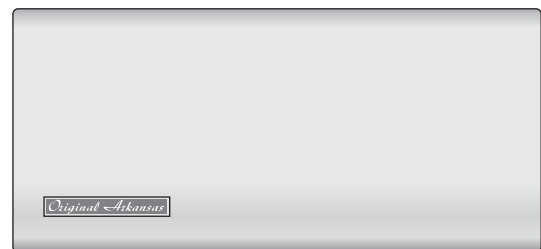
**DB-299**  
ARKANSAS  
conica n° 299



**DB-OL**  
30 cc



**DB-96**  
ARKANSAS  
piatta n° 8



**DB-6A**  
ARKANSAS n° 6A



**DB-4**  
ARKANSAS  
piatta n° 4



**DB-22A**  
ARKANSAS



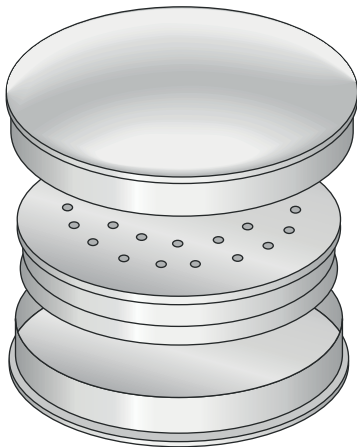
19

Bacinelle, Scatole per sterilizzazione  
Sterilizing containers  
Steril-Container  
Containers pour stérilizer  
Contenedores para esterilizaciòn



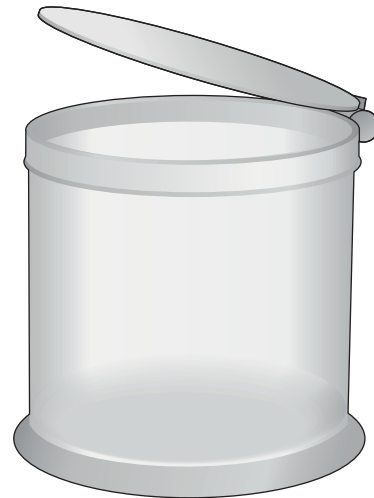


Scatola per sterilizzazione aghi da sutura - Box for needles  
Sterilbehälter für Nadeln - Boite pour aiguilles de suture  
Estuche para agujas

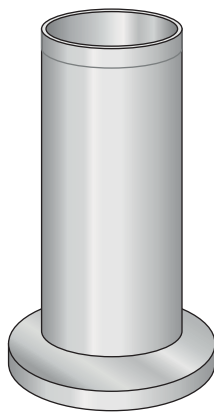


**BS-1**  
Ø 78 mm h 15 mm

Vaso in vetro con coperchio in acciaio inox  
Jar in glass with lid in stainless steel  
Pot en verre avec couvercle en acier inox



**VPC-6** Ø 100x100 mm  
**VPC-8** Ø 120x120 mm

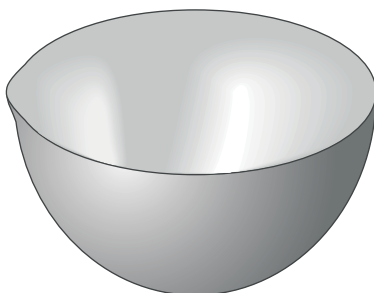


**CS-51** Ø 50 mm h 100 mm  
**CS-52** Ø 50 mm h 150 mm  
**CS-55** Ø 80 mm h 180 mm

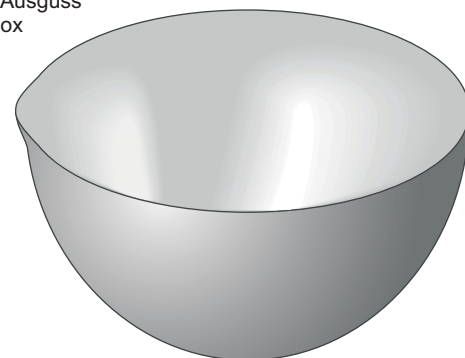


**VPC-10** Ø 100x100 mm  
**VPC-12** Ø 120x120 mm

Capsule inox con fondo piano e becco  
Lotion bowis capsules  
Runder Sterilbehälter mit Ausguss  
Capsule en acier inox



**CS-01** Ø 40 mm 15 cc  
**CS-02** Ø 60 mm 75 cc  
**CS-03** Ø 80 mm 225 cc  
**CS-04** Ø 100 mm 325 cc  
**CS-05** Ø 120 mm 500 cc  
**CS-06** Ø 150 mm 600 cc



**CS-80** Ø 180 mm 1000 cc  
**CS-81** Ø 200 mm 1450 cc  
**CS-82** Ø 220 mm 2000 cc  
**CS-83** Ø 240 mm 3300 cc



Contenitori per sterilizzare

Sterilizing containers

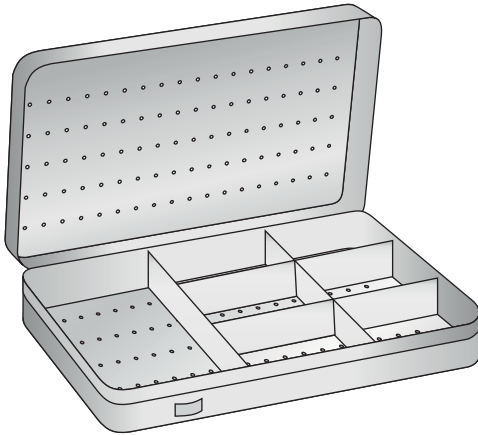
Steril Container

Containers pour stérilizer

Contenedores para esterilización

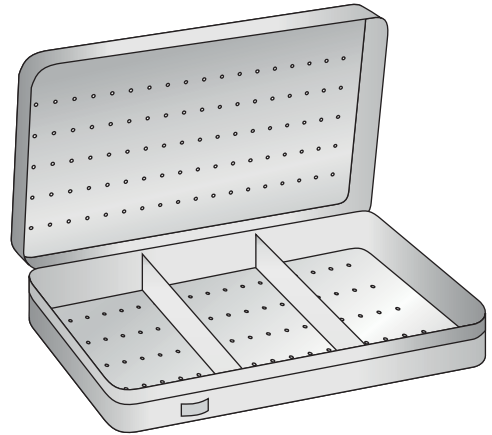
Inox - Stainless steel - Rostfrei  
Inoxidable

Bacinella a 7 scomparti



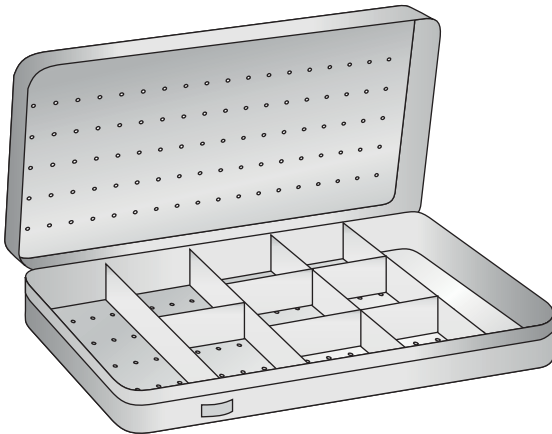
**BS-27**  
150 x 90 x 20 mm

Bacinella a 3 scomparti

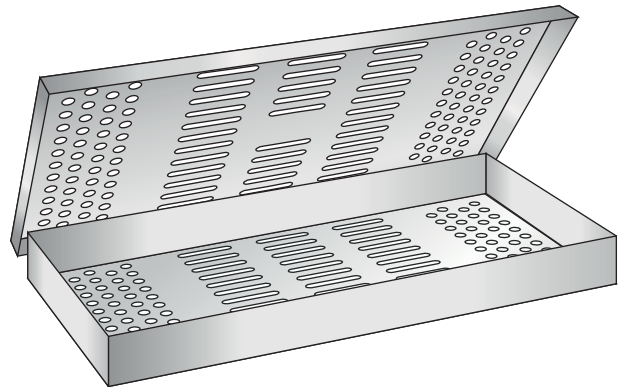


**BS-23**  
150 x 90 x 20 mm

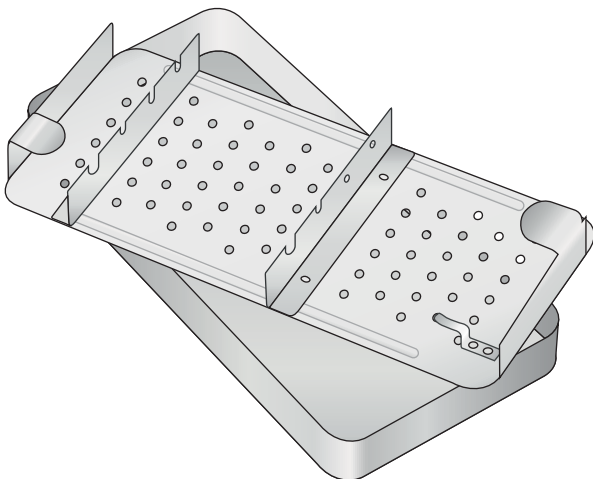
Bacinella a 10 scomparti



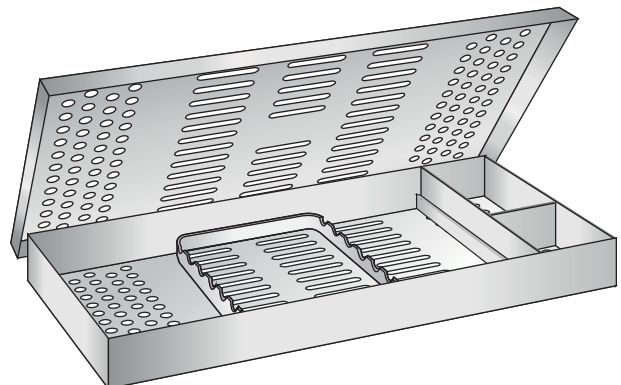
**BS-28**  
220 x 120 x 20 mm



**BS-41**  
275 x 130 x 25 mm



**BS-30**  
180 x 90 x 35 mm 2 ripiani



**BS-40** 275 x 130 x 25 mm Con griglia e scomparti  
**BS-42** 285 x 190 x 25 mm Con griglia e scomparti

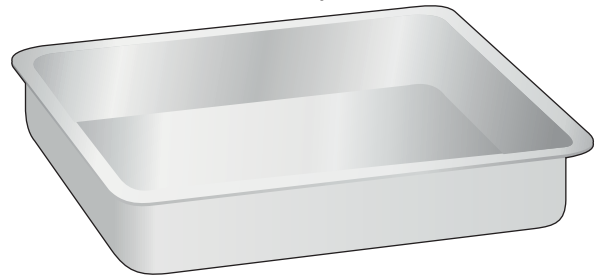


Bacinelle reniformi  
Kidney bowls  
Nierenschalen  
Bassins réniformes  
Riñoneras



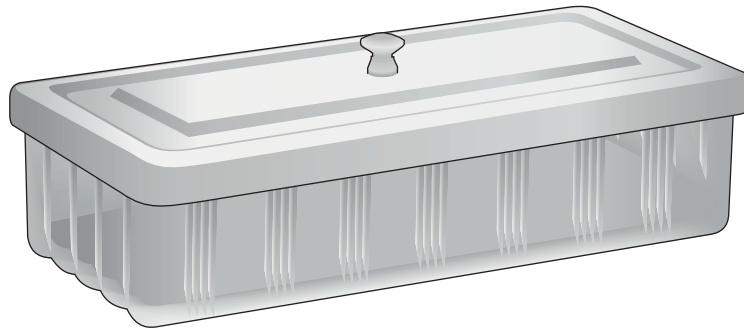
**BR-20** 200 mm  
**BR-25** 250 mm  
**BR-28** 280 mm

Vassoi porta-strumenti  
Trays  
Schalen  
Bassins  
Bandejas



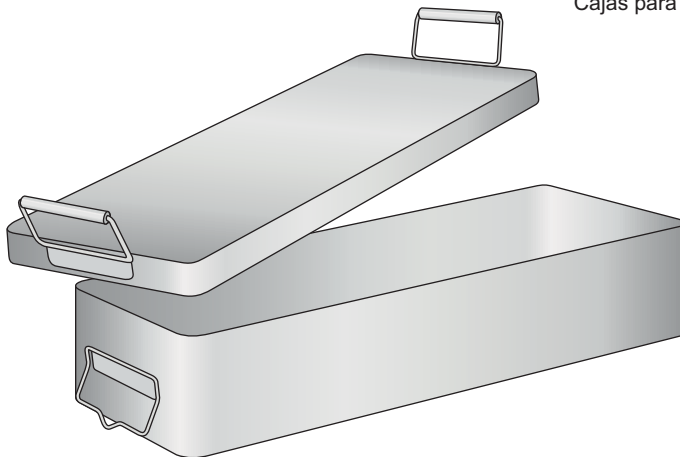
**VS-20** 210 x 110 x 25 mm  
**VS-26** 250 x 180 x 30 mm  
**VS-30** 300 x 220 x 30 mm

Bacinella in vetro con coperchio e pomolo in acciaio inox  
Container in glass with lid and knob in stainless steel  
Cuvette en verre avec couvercle et pommeau en acier inox

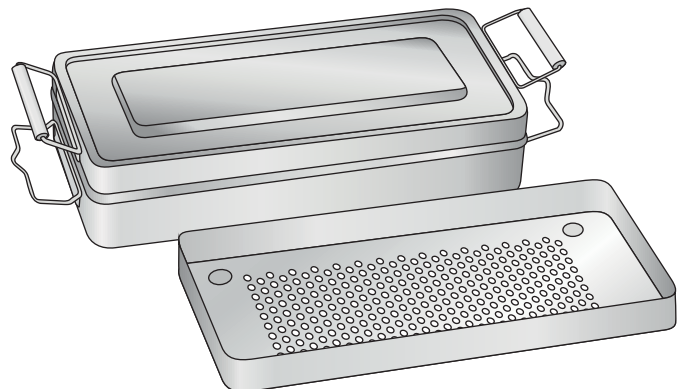


**BPS-10** 140 x 80 x 50 mm  
**BPS-12** 200 x 60 x 40 mm  
**BPS-14** 220 x 100 x 50 mm  
**BPS-15** 220 x 140 x 60 mm  
**BPS-17** 300 x 180 x 65 mm

Scatole per sterilizzazione a secco  
Instrument boxes  
Instrumentenkästen  
Boîtes pour instruments  
Cajas para instrumentos



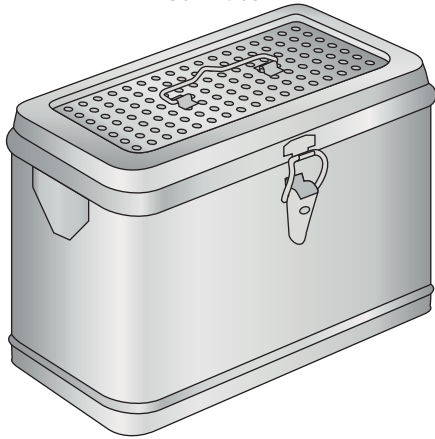
**CS-07** 280 x 140 x 60 mm  
**CS-08** 300 x 140 x 60 mm  
**CS-09** 360 x 160 x 70 mm



**CS-61** 150 x 90 x 40 mm  
**CS-63** 200 x 100 x 60 mm  
**CS-65** 250 x 120 x 60 mm  
**CS-66** 280 x 140 x 60 mm  
**CS-67** 320 x 150 x 60 mm

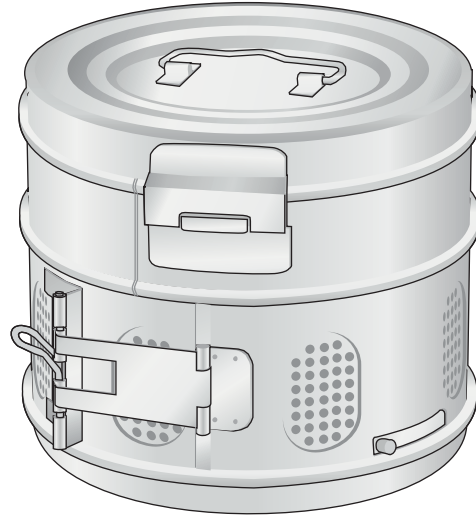


Cestelli rettangolari con filtro  
Mit filter  
Whith filter  
Avec filtre  
Con filtros



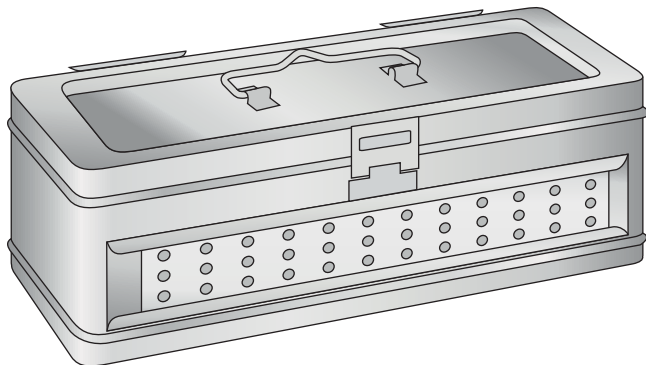
- CS-40** 200 x 180 x 120 mm
- CS-41** 200 x 180 x 180 mm
- CS-42** 250 x 250 x 250 mm
- CS-43** 270 x 160 x 160 mm
- CS-44** 290 x 290 x 290 mm
- CS-45** 350 x 230 x 200 mm

Cestelli cilindrici  
Dressing sterilizing drums  
Verbandstoffrommeln  
Boites à stérilisation  
Cajas para esterilización



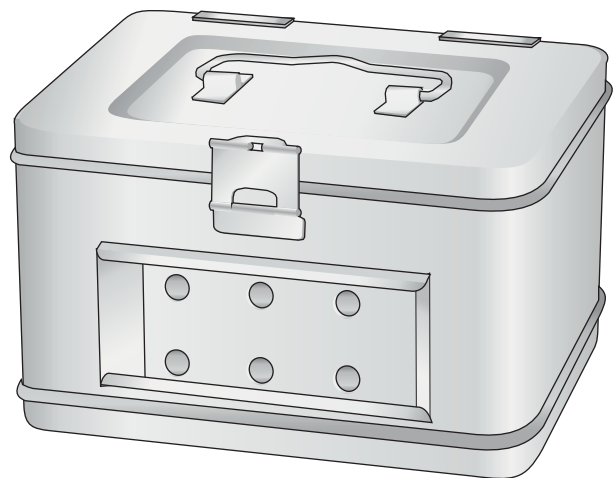
- CS-12** 125x125 mm
- CS-15** 150x150 mm
- CS-19** 190x145 mm
- CS-30** 290x240 mm

Cestelli rettangolari  
Rectengular drum  
Panier rectangulaire



- CS-32** 300 x 150 x 60 mm
- CS-33** 300 x 150 x 90 mm
- CS-34** 300 x 150 x 180 mm

Cestelli rettangolari  
Rectengular drum  
Panier rectangulaire

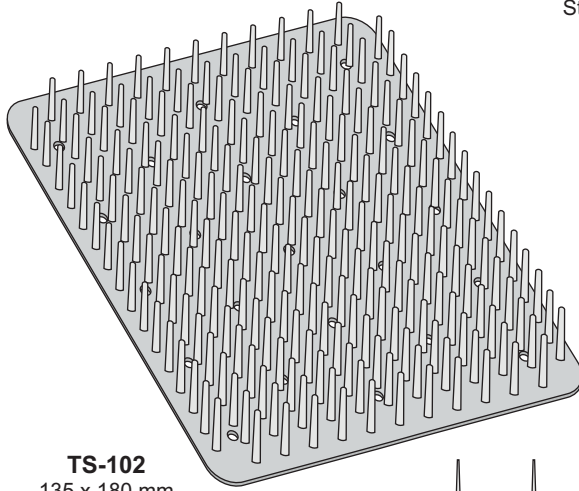


- CS-21** 190x110x120 mm
- CS-20** 200x180x120 mm
- CS-22** 200x180x180 mm
- CS-25** 250x200x200 mm

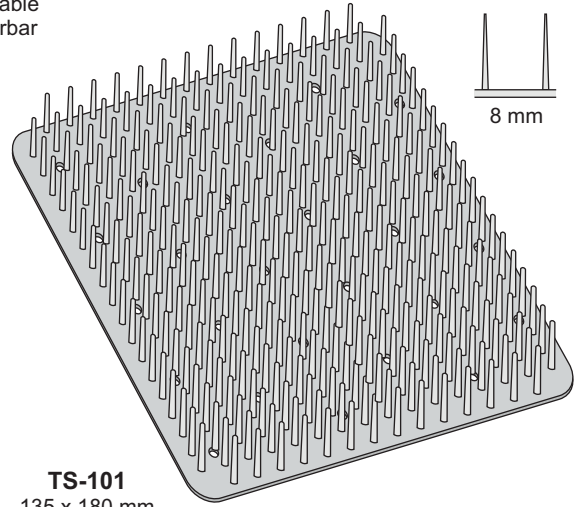
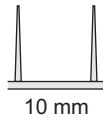




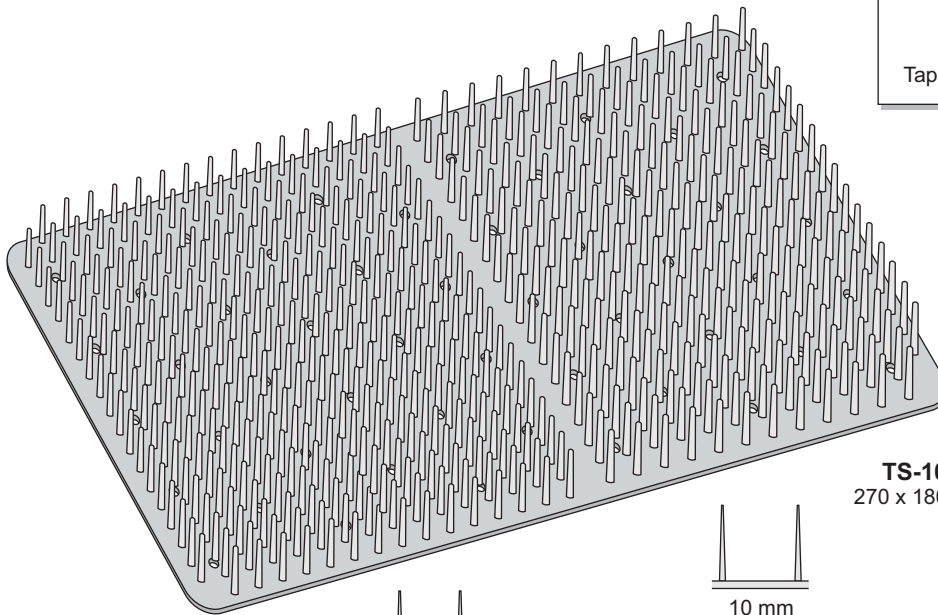
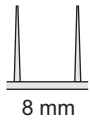
Autoclavabili  
Autoclavable  
Sterilisierbar



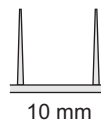
**TS-102**  
135 x 180 mm



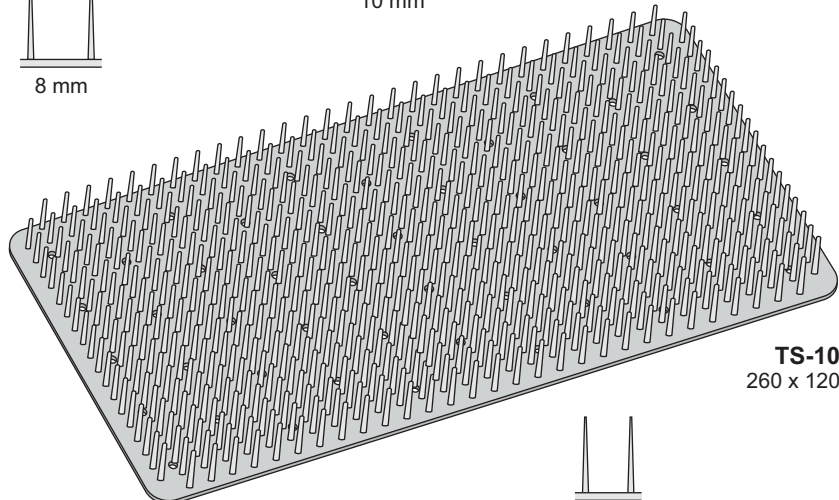
**TS-101**  
135 x 180 mm



**TS-104**  
270 x 180 mm



Tappeti in aghi di silicone  
Silikon matte  
Matte en silicone  
Tapis en Silicone  
Tapete en agujas de silicona



**TS-103**  
260 x 120 mm

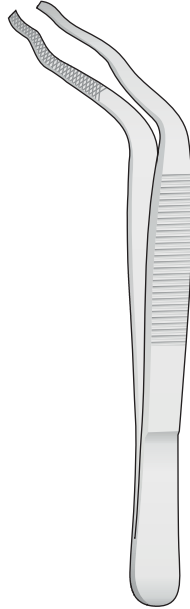




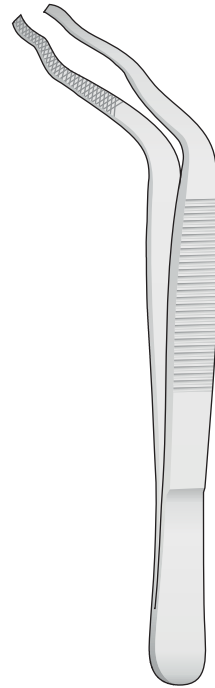
Pinze per prelevare strumenti sterilizzati  
Sterilizing forceps for picking up and holding of sterile instruments  
Sterilisierzangen zum Fassen und Halten Steriler Instrumente



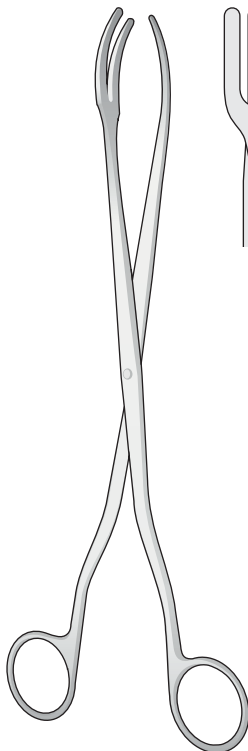
**GS-02**  
145 mm



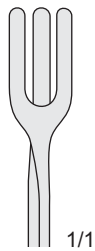
DAVIS  
**GS-03**  
160 mm



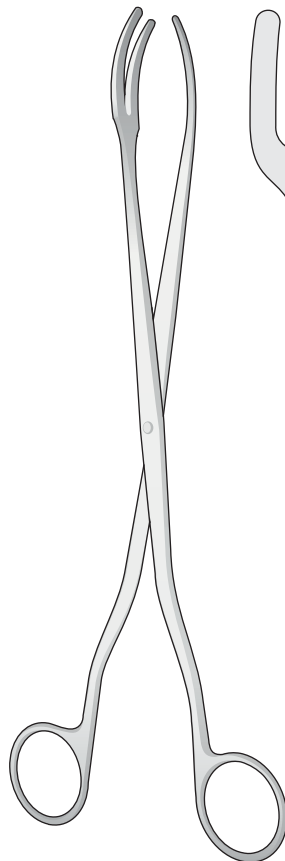
DAVIS  
**GS-04**  
200 mm



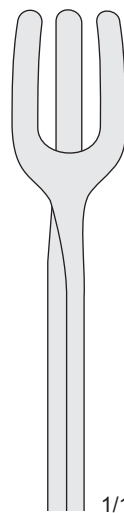
**GS-10**  
200 mm



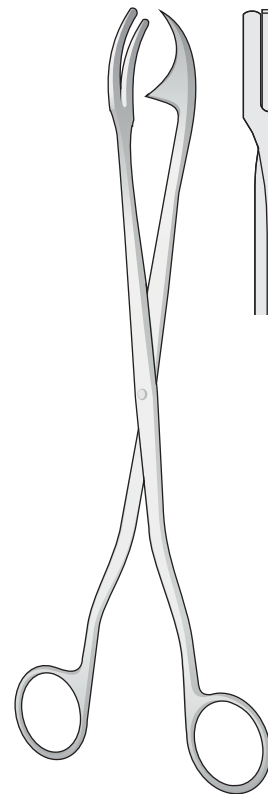
1/1



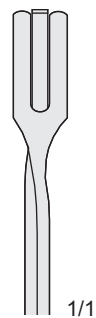
**GS-11**  
300 mm



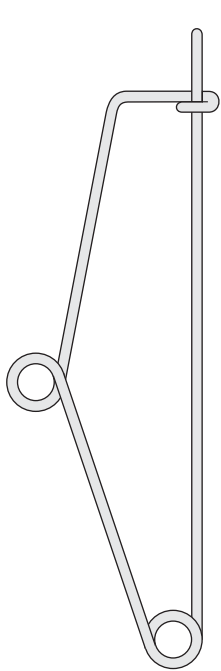
1/1



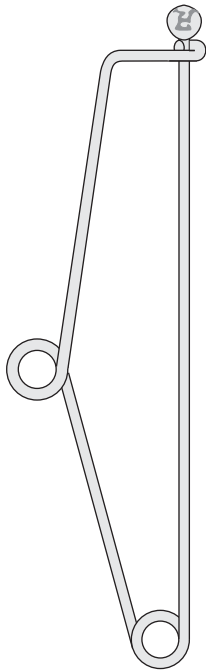
ROGGE  
**GS-06**  
230 mm



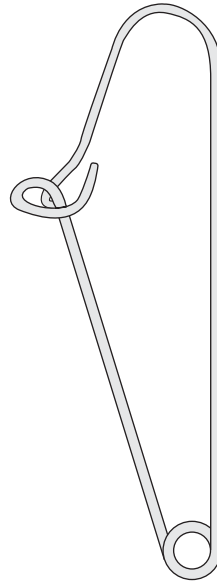
1/1



MAYO  
GS-01  
140 mm

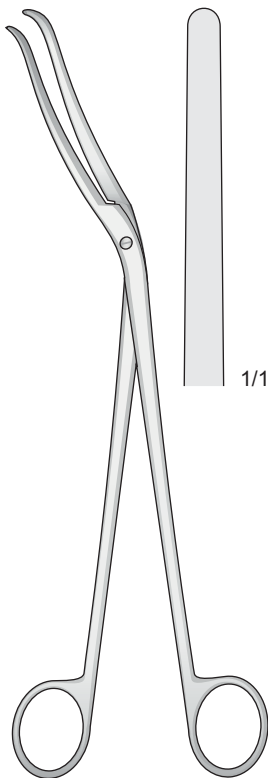


MAYO  
GS-07  
140 mm

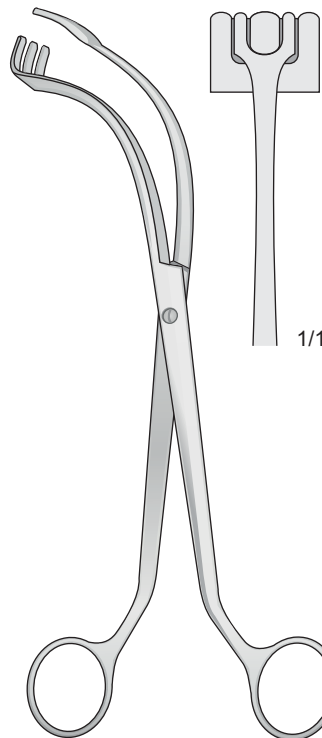


BUNT  
GS-09  
110 mm

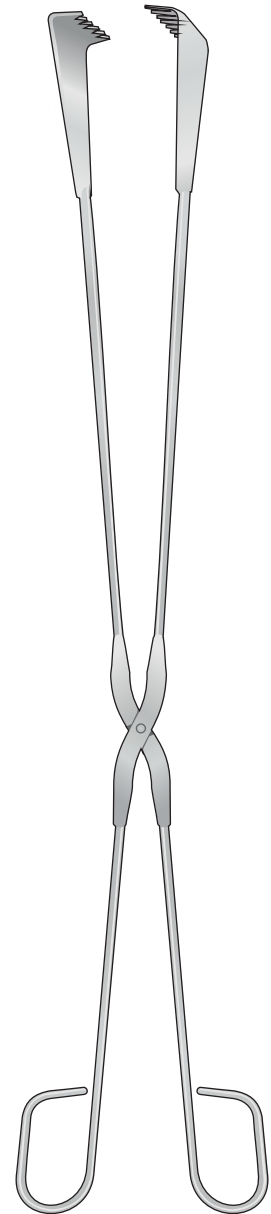
Pinza per materiali da medicazione  
e tamponi usati  
Operating room pick-up forceps  
for used tampons and dressings  
Fasszange für verbrauchtes  
verbandmaterial und Tupfer  
Pince pour pansements  
et tampons souillés  
Pinzas para desechos



CHEATTLE  
GS-05  
265 mm



COLLIN  
GS-30  
250 mm



SAUERBRUCH  
GS-31  
530 mm









<b>A</b>	
<b>ADLERKREUTZ</b> , Pinzette chirurgiche	124
<b>ADSON</b> , Cannule per aspirazione	674
- Divaricatori	338, 339, 341, 343
- Periostotomi	401
- Pinzette anatomiche chirurgiche	116, 130
<b>ADSON-BROWN</b> , Pinzette chirurgiche	116
<b>ALAN-PARKS</b> , Divaricatore	370
<b>ALDERDYCE</b> , Periostotomo	395
<b>ALEXANDER</b> , Pinza ossivora	468
- Pinza per biopsia	649
<b>ALLIS</b> , Pinze per tessuti	145, 223
<b>ALLISON</b> , Divaricatori	318
<b>ALM</b> , Divaricatori	327
<b>ANDERSON-ADSON</b> , Divaricatori	335
<b>ANDREWS-PYNCHON</b> , Cannule per aspirazione	662
<b>ANEL</b> , Aghi lacrimali	593
<b>ANGLE</b> , Tronchese per fili metallici	510
<b>ARKANSAS</b> , Pietre per affilatura strumenti	688
<b>ARRUGA</b> , Port'aghi	261
- Uncino intracapsulare	592
<b>ASH</b> , Pinze nasali	563
<b>AUFRICHT</b> , Elevatore del setto nasale	565
- Lime per osso	409
<b>AUSTIN</b> , Pinzette chirurgiche	115
<b>B</b>	
<b>BABBUSH</b> , Elevatori	395
<b>BABCOCK</b> , Pinze intestinali	144, 223
- Sonde doppie malleabili	680
<b>BABINSKY</b> , Martello percussore	3
<b>BABY-ADSON</b> , Pinze emostatiche e legature	160
<b>BABY-ALLIS</b> , Pinze per tessuti	145
<b>BABY-CRILE</b> , Pinze emostatiche	152
<b>BABY-CRILE-WOOD</b> , Port'aghi	250
<b>BABY-COLLIN</b> , Divaricatori	346
<b>BABY-FINOCCHIETTO</b> , Divaricatore	365
<b>BABY-METZENBAUM</b> , Forbici chirurgiche	59
<b>BABY-MIXTER</b> , Pinze emostatiche	160
<b>BABY-MORSE</b> , Divaricatore costale	367
<b>BABY-WEITLANER</b> , Divaricatori	330
<b>BABY-YANKAUER</b> , Cannule per aspirazione	662
<b>BACKHAUS</b> , Fissateli	146
<b>BAILEY</b> , Divaricatori costali	368
<b>BAINBRIDGE</b> , Pinze intestinali	166
<b>BAKES</b> , Dilatatori per vie biliari	625
<b>BALFOUR</b> , Divaricatori addominali	358, 359, 360
<b>BALFOUR-BABY</b> , Divaricatore addominale	358
<b>BALLENGER</b> , Coltelli per setto nasale	569
- Scalpelli	565
<b>BARON</b> , Cannule per aspirazione	670
<b>BARR</b> , Divaricatore anale	370
<b>BARRAQUER</b> , Blefarostati	598
- Micro Pinzette oftalmiche	595
- Micro Port'aghi	609, 610, 611
- Pinzette	135
- Port'aghi	234
<b>BARTH</b> , Cucchiali taglienti	416
<b>BAUMGARTNER</b> , Port'aghi per legature	511
<b>BEACHAM</b> , Amniotomo	643
<b>BECK</b> , Pinza vascolare	207
<b>BECKMANN</b> , Adenotomi	576
- Divaricatori	342
<b>BECKMANN-EATON</b> , Divaricatore	343
<b>BEEBE</b> , Forbici per fili metallici	103
<b>BEER</b> , Pinzetta da depilazione	135
<b>BELLUCCI</b> , Cannula per aspirazione	670
- Micro forbice	554
<b>BENGOLEA</b> , Pinze emostatiche	159
<b>BENIQUE</b> , Mandrino per introduzione sonde	624
<b>BENNET</b> , Elevatori	393
<b>BERGH</b> , Pinzetta da depilazione	135
<b>BERGMANN</b> , Martelli chirurgici	430
<b>BERNHARD</b> , Pinze fissateli	148
<b>BEYER</b> , Pinza ossivora	470
<b>BILLEAU</b> , Anse auricolari	551
<b>BIRKETT</b> , Pinze emostatiche	158
<b>BLAKE</b> , Curette uterina	652
<b>BLOHMKE</b> , Pinza da intestino	174
<b>BLOUNT</b> , Elevatore	389, 393
<b>BLUMENTHAL</b> , Pinza ossivora	467
<b>BÖHLER</b> , Pinze ossivore	474
<b>BONNEY</b> , Pinzetta chirurgica	131
<b>BOWLED-HENRY</b> , Divaricatore	311
<b>BOWMAN</b> , Sonde bottonute	276
<b>BOYNTON</b> , Port'aghi	249, 261
<b>BRAUN</b> , Forbice chirurgica	
- Pinze per peducolo renale	629
<b>BRAUN-STADLER</b> , Forbice chirurgica	77
<b>BREISKY</b> , Valve vaginali	638
<b>BROCK</b> , Forbici	41
- Pinzette	109
- Port'aghi	233
<b>BROWN</b> , Pinzette chirurgiche	125
<b>BRUENINGS</b> , Abbassalingua	4
<b>BRUNNER</b> , Aghi per legature	268, 505
- Costotomi	477
<b>BRUNS</b> , Cucchiali taglienti	419
- Forbice per bendaggi	101
<b>BUCHWALD</b> , Abbassalingua	4
<b>BÜCHS</b> , Divaricatore	311
<b>BUCK</b> , Martello percussore	3
<b>BUCK-GRAMCKO</b> , Elevatore	389
<b>BUCKLEY</b> , Osteotomi	434
<b>BUELAU</b> , Trokare	377
<b>BUMM</b> , Curette uterine	654, 655
<b>BUNT</b> , Spillone per sterilizzazione	697
<b>BUSHE</b> , Cucchiali taglienti	423
<b>C</b>	
<b>CAPLAN</b> , Forbice per rinologia	564
<b>CASPAR</b> , Cucchiali taglienti	425
- Divaricatori	304, 352, 353
- Divaricatori lombari	354, 355
- Misuratore	22
- Battitore	433
- Pinze per biopsia	462, 463
<b>CASTANEDA</b> , Pinze vascolari	182
<b>CASTROVIEJO</b> , Blefarostati	599
- Micro divaricatori	591
- Micro forbici oftalmiche	603
- Micro pinzette oftalmiche	596
- Micro spatole	592
- Port'aghi	238, 239, 240, 241, 242
- Strumenti per misura	19, 20, 21
<b>CHADWICK</b> , Forbici delicate	46
<b>CHARNELY</b> , Divaricatore	364
<b>CHEATTLE</b> , Pinze per sterilizzazione	697
<b>CHILD</b> , Pinza per tamponi	8, 143
<b>CINELLI</b> , Scalpelli nasali	567
<b>CITELLI</b> , Pinza ossivora	453
<b>CLEANLACT</b> , Lubrificante per strumenti chirurgici	687
<b>CLOWARD</b> , Divaricatori	345
- Divaricatori vertebrali	356
<b>CLOWARD-CONTOUR</b> , Divaricatori	329
<b>COAKLEY</b> , Curette taglienti	575
<b>COBB</b> , Raspatori	407
<b>COLIBRI</b> , Micro pinzette	594
<b>COLLIN</b> , Costotomo	475
- Divaricatori	346, 347, 348
- Pinze emostatiche	139, 143, 633
- Pinza tira-lingua	7
- Pinze per agrafes	271
- Pinze per sterilizzazione	697
- Segna per amputazione	414
<b>COLLIN-Standard</b> , Speculum vaginali	634
<b>CONVERSE</b> , Divaricatori	288
- Port'aghi	250
- Tenotomo	28
<b>COOLEY</b> , Dilatatori per valvola mitralica	229
- Divaricatori costali	324, 366
- Pinze vascolari	212, 213, 214, 215, 216
<b>COOPER</b> , Aghi per legature	267
<b>COOK</b> , Blefarostati	599



<b>CORYLLOS</b> , Divaricatori	315
<b>COTTLE</b> , Divaricatori	284
- Periostotomo	396
- Forbici delicate	71
- Lime per osso	409
- Martello chirurgico	430
- Osteotomi	438, 579
- Pinzette, columella	129
- Raspatore-Elevatore nasale	565
- Speculum nasali	559
- Strumento per cartilagine	564
<b>COTTLE-MASING</b> , Forbici delicate	46
<b>COTTLE-NEIVERT</b> , Divaricatore doppio	565
<b>COTTLE-WALSHAM</b> , Pinze nasali	563
<b>COUPLAND</b> , Cannule per aspirazione	664, 665
<b>CRAFOORD</b> , Pinze per legature	163
<b>CRILE</b> , Pinze emostatiche	151, 152
<b>CRILE-WOOD</b> , Port'aghi	243, 250, 252
<b>CRILE-MURRAY</b> , Port'aghi	243
<b>CUSCO</b> , Speculum vaginali	634
<b>CUSHING</b> , Divaricatore	288, 289, 292
- Periostotomo	401
- Pinze per biopsia	461
- Pinze ossivore	469
- Pinzette	121, 131
- Spatole cerebrali	326
<b>CUSHING-KOCHER</b> , Divaricatore	292

**D**

<b>DALE</b> , Pinze vascolari	217
<b>DANDY</b> , Forbice delicate	70
- Pinza chirurgica	151
- Pinza emostatica	151
<b>DAUBENSPECK</b> , Cucchiari taglienti	423
<b>DAUTREY-MUNRO</b> , Osteotomi	581
<b>DAVIDSON</b> , Divaricatori	316
<b>DAVIS</b> , Elevatore	382
- Pinze per sterilizzazione	696
<b>DAVIS-BOYLE</b> , Apribocca	541
<b>DAY</b> , Uncini per otologia	551
<b>DE BAKEY</b> , Cannule per aspirazione	664
- Dilatatori vascolari	226
- Forbici	73
- Port'aghi	255
<b>DE BAKEY-BAHNSON</b> , Pinze vascolari	193
<b>DE BAKEY-BAINBRIDGE</b> , Pinze vascolari	187
<b>DE BAKEY-CAROTIS</b> , Pinze vascolari	180
<b>DE BAKEY-MOSQUITO</b> , Pinze vascolari	185
<b>DE BAKEY-HARKEN</b> , Pinze vascolari	200
<b>DE BAKEY-PEAN</b> , Pinze vascolari	186
<b>DE BAKEY (POTTS-SMITH)</b> , Forbici	73
- Pinzette	126, 127, 128, 132
- Pinze vascolari	183, 203
<b>DE BAKEY-RANKIN</b> , Pinze vascolari	185
<b>DE BAKEY-SATINSKY</b> , Pinze vascolari	180, 198
<b>DEAN</b> , Forbice dentellata	70
<b>DEAVER</b> , Forbici chirurgiche	57
- Divaricatori	320, 321
<b>DEJERINE</b> , Martello percussore	3
<b>DEMEL</b> , Passafili	504
<b>DENIS-BROWN</b> , Divaricatori	362
<b>DERF</b> , Port'aghi	243, 250
<b>DERRA</b> , Pinze vascolari	189
<b>DESCHAMPS</b> , Aghi per legature	262, 263, 264, 265, 266
<b>DESJARDINS</b> , Dilatatori per calcoli renali	623
- Dilatatori per calcoli biliari	628
<b>DESMARRES</b> , Bisturi	28
- Divaricatori	287
- Pinzette	129
<b>DIETER</b> , Micro ossivora	554
<b>DIETRICH</b> , Forbici	74
- Pinze vascolari	205
- Port'aghi Micro	240
<b>DIFFENBACH</b> , Pinze bulldog clamps	177
<b>DIXON-LOVELACE</b> , Pinze emostatiche	158
<b>DINGMANN</b> , Apribocca	542
- Pinze per chirurgia ossea	485
<b>DITTEL</b> , Dilatatori per calcoli biliari	626

<b>DOCKHORN</b> , Divaricatori	305
<b>DOLWICK-REICH</b> , Divaricatori	337
<b>DOYEN</b> , Fissateli	146
- Divaricatore	308, 363
- Pinze atraumatiche	171
- Raspatori	404
- Sonde	275
- Strumenti per fibromi	645
- Valve vaginali	637
<b>DOYEN-COLLIN</b> , Apribocca	6, 537
<b>DOYEN-JANSEN</b> , Apribocca	6, 537
<b>DOYEN-STILLE</b> , Divaricatori	308
<b>DUBOIS</b> , Forbici chirurgiche	77
<b>DUKE</b> , Trokare	377
<b>DUNN-DAUTREY</b> , Divaricatori-Retrattori	546
<b>DUPLAY</b> , Speculum nasale	18
<b>DUPUY-WEISSE</b> , Aghi per legature	262
<b>DURANTE</b> , Pinzette	125
<b>DUVAL</b> , Pinzette chirurgiche	129
- Pinza atraumatica	223
- Pinze emostatiche	145, 629
<b>DUVAL-COLLIN</b> , Pinze intestinali	629

**E**

<b>ECHLIN</b> , Pinze ossivore	470
<b>EDER</b> , Porta cotone	279
<b>EISELBERG-MATHIEU</b> , Port'aghi	249
<b>ELLIS</b> , Micro bisturi	589
<b>EPKER</b> , Osteotomi	578
<b>ESMARCH</b> , Forbice per bendaggi	101

**F**

<b>FAGER</b> , Elevatori	382
<b>FAHLBUSCH</b> , Micro forbici per rinologia	555
<b>FARABEUF</b> , Divaricatori	290
- Pinze ossivore	478
- Raspatori	402
<b>FARABEUF-LAMBOTTE</b> , Pinze ossivore	478
<b>FARREL</b> , Porta cotone	277
<b>FAULKNER</b> , Micro pinzetta oftalmica	596
<b>FAURE</b> , Fissateli	146
- Pinza per biopsia	648
<b>FEICHENFELD</b> , Pinzette chirurgiche	134
<b>FEIN</b> , Porta cotone	278
<b>FENO</b> , Speculum vaginale	656
<b>FERGUSSON</b> , Cannule per aspirazione	669
- Pinze per angiotribi	166
<b>FERRIS-SMITH-KERRISON</b> , Laminotomi	454, 455, 456, 457
<b>FERRIS-SMITH-CUSHING</b> , Laminotomi	458
<b>FIBULA</b> , Pinze per chirurgia ossea	479
<b>FINOCCHIETTO</b> , Divaricatori	365
- Port'aghi	257
<b>FINSEN</b> , Divaricatori	327
<b>FINSTERER</b> , Cannule per aspirazione	664
<b>FOERSTER-BALLENGER</b> , Pinze per tamponi	141
<b>FOMON</b> , Divaricatori	284
- Forbici curve	59, 70, 71
- Lime per osso	410, 412, 572
- Scalpelli nasali	567
<b>FRANKFELDT</b> , Porta cotone	279
<b>FRAZIER</b> , Cannule per aspirazione	669, 674, 680
- Divaricatore	350
<b>FREER</b> , Periostotomo	395
- Scalpelli	434
- Bisturi per mucosa	572
<b>FRENZEL</b> , Abbassalingua	4
<b>FRIEDMANN</b> , Pinze ossivore	467

**G**

<b>GABON</b> , Macinino per osso	586
<b>GALLAHER</b> , Lime per osso	408
<b>GARRETT</b> , Dilatatori vascolari	227
<b>GELLHORN</b> , Pinza per biopsia	647
<b>GELPI</b> , Divaricatori	328





<b>GELPI-LOKTITE</b> , Divaricatore	329
<b>GELPI-SELETZ</b> , Divaricatore	329
<b>GEMINI</b> , Pinze emostatiche e legature	162
<b>GENTOFT</b> , Speculum vaginale	656
<b>GERALD</b> , Pinzette chirurgiche	123
<b>GERALD-BROWN</b> , Pinzetta chirurgica	123
<b>GERSTER</b> , Riposizionatori ossei	487
<b>GERSTER-LOWMAN</b> , Riposizionatori ossei	487
<b>GIDEF</b> , Pinze emostatiche	150
<b>GIERTZ-STILLE</b> , Costotomo	477
<b>GIGLI</b> , Seghe per amputazione	414
<b>GIL-VERNET</b> , Divaricatori	293
<b>GILLIES</b> , Divaricatori	283
- Port'aghi	253, 274
<b>GLASSMAN</b> , Forbici chirurgiche	52
<b>GLOVER</b> , Pinze bulldog	179, 180
- Pinze vascolari	207
<b>GOLDMAN-FOX</b> , Forbici chirurgiche	49, 50, 80, 84
<b>GOELET</b> , Divaricatore	291
<b>GORNEY</b> , Forbici chirurgiche	68
- Raschietti con aspirazione	667
<b>GOSSET</b> , Divaricatori addominali	357
<b>GOURDET</b> , Curette uterine	651
<b>GRAEFE</b> , Forbici delicate	46
- Pinzette per micro chirurgia	114, 129
- Micro divaricatori	589, 590
- Micro Bisturi	27, 590
<b>GRAY</b> , Pinze per legature	164
<b>GRAVE</b> , Speculum vaginali	634
<b>GREGORY</b> , Pinze vascolari	207
<b>GREENE</b> , Divaricatore	311
<b>GROSS</b> , Pinze emostatiche	139, 141
<b>GRUENWALD</b> , Pinzette chirurgiche	133
<b>GUILLIEN</b> , Cannula per aspirazione	667
<b>GUSBERG</b> , Curette per biopsia endocervicale	646
<b>GUTHRIE</b> , Divaricatori	283
<b>GUYON</b> , Dilatatori per calcoli biliari	628
- Mandrino per introduzione sonde	624
- Pinze per peduncoli renali	175
- Pinze renali	629

**H**

<b>HABERER</b> , Spatole malleabili	326
<b>HAGLUND</b> , Pinze per gesso	533
<b>HALLE</b> , Cucchiai taglienti	422
<b>HALSEY</b> , Port'aghi	243, 250
<b>HALSTED</b> , Pinze emostatiche	150, 152
<b>HALSTED-MOSQUITO</b> , Pinze emostatiche	149, 152
<b>HANK</b> , Dilatatori uterini	641
<b>HARRINGTON</b> , Divaricatori	317
<b>HARTMANN</b> , Abbassalingua	544
- Cannule per aspirazione	676, 677
- Diaphason	5
- Porta cotone	278
- Pinza ossivora	469
- Pinze auricolari	552, 553
- Speculum nasali	18, 560, 561
<b>HARTMANN-BABY-MOSQUITO</b> , Pinze emostatiche	149
<b>HAYES</b> , Pinze atraumatiche	218
<b>HEANEY</b> , Port'aghi	257
<b>HEANEY-HEGAR</b> , Port'aghi	244
<b>HEAT</b> , Martello chirurgico	431
<b>HEGAR</b> , Dilatatori uterini	639, 641
- Port'aghi	244, 251
<b>HEGAR-MAYO-SEELEY</b> , Port'aghi	245, 252
<b>HEGENBARTH</b> , Pinzetta chirurgica	271
<b>HEILDELBERG</b> , Porta cotone	278
<b>HEISS</b> , Pinze emostatiche	158
<b>HEISTER</b> , Apribocca	6, 537
<b>HEMINGWAY</b> , Cucchiai taglienti	415
<b>HENAHAN</b> , Periostotomi	401
<b>HENLEY</b> , Divaricatori	344
<b>HENNIG</b> , Pinze per gesso	533
<b>HEPARIN</b> , Aghi malleabili	682
<b>HEYMANN</b> , Forbici angolate	71
<b>HEYMANN-KNIGHT</b> , Forbice angolata	71
<b>HIBBS</b> , Divaricatori	297
- Osteotomi	439

<b>HOHMANN</b> , Elevatori	391, 394
<b>HOLZBACH</b> , Divaricatori	349
<b>HÖPFNER</b> , Pinze per intestino	174
<b>HOPT</b> , Pinze vascolari	219
<b>HOUSE</b> , Cannule per aspirazione	672
<b>HOWARD</b> , Lime per osso	408, 570
<b>HOWARTH</b> , Periostotomi	397
<b>HUNTER</b> , Pinze per frammenti	134
<b>HURD</b> , Periostotomi	397

**I**

<b>INGE</b> , Divaricatori vertebrali	356
<b>IRIS</b> , Forbici delicate	44, 81, 83, 84, 99
<b>ISRAEL</b> , Divaricatori	298
<b>ITARD</b> , Cannule per aspirazione	677

**J**

<b>JACKSON-TESSIER</b> , Forbice ossivora	476
<b>JACOBSON</b> , Cucchiai taglienti	416
- Micro Forbice	40
- Mandrini	501, 502, 503, 527
- Port'aghi	235, 241
<b>JACOBSON-UNIVERSAL</b> , Mandrino	527
<b>JAMESON</b> , Forbici delicate	47
<b>JAMESON-WERBER</b> , Forbici delicate	47
<b>JANSEN</b> , Cucchiai taglienti	416
- Divaricatore	327
- Pinze ossivore	469
- Pinzetta	133
- Raspatore	402
<b>JANSEN-LEUER</b> , Pinza ossivora	468
<b>JAVID</b> , Pinze vascolari	222
<b>JONES</b> , Fissateli	146
- Pinza emostatica	139
<b>JOSEPH</b> , Divaricatori	284
- Forbici chirurgiche	58
- Lime per osso	408
- Lime nasali	573, 574
- Periostotomi	401
<b>JUDD-MASSON</b> , Divaricatori da prostata	369

**K**

<b>KALLMORGEN</b> , Valve vaginali	635
<b>KELLY</b> , Divaricatori	310
- Forbici chirurgiche	53, 85
- Pinze emostatiche	155
<b>KERN</b> , Pinze per chirurgia ossea	486
<b>KERPEL</b> , Cucchiai taglienti	418
<b>KERSHNER</b> , Divaricatori oftalmici	598
<b>KERRISON</b> , Laminotomi	453
<b>KERRISON-JACOBY</b> , Laminotomi	455
<b>KEVORKIAN</b> , Pinza per biopsia	650
<b>KEY-HORSLEY</b> , Pinze ossivore	475
<b>KEYES</b> , Punche da biopsia	28, 491
<b>KILLIAN</b> , Cannule per aspirazione	678
- Forbice nasale	72
- Forbice per rinologia	564
- Scalpelli	565
- Speculum nasali	560, 561
<b>KILLIAN-KLAUS</b> , Osteotomo	565
<b>KILNER</b> , Forbici	47, 52, 85
- Port'aghi	256
<b>KILNER-DOUGHTY</b> , Apribocca	540
<b>KIMURA</b> , Micro spatola	592
<b>KIRSCH</b> , Divaricatori	304
<b>KIRSCHNER</b> , Divaricatori	361
<b>KLIMA-ROSEGGER</b> , Ago da biopsia	377
<b>KOCHER</b> , Aghi per legature	267
- Divaricatori	292, 294, 296, 301, 305, 307
- Pinze emostatiche	153, 155, 157
- Pinze intestinali	172, 173
- Sonde conduttrici	269
<b>KOCHER-LANGENBECK</b> , Divaricatori	300
<b>KOCHER-OCHSNER</b> , Pinze chirurgiche	154



<b>KOENIG</b> , Sonda conduttrice	269
<b>KOERTE</b> , Divaricatore	323
<b>KÖNIG</b> , Elevatori	381
<b>KRAUSE</b> , Strumento per tonsille	562
- Trokare	375
<b>KRESSNER</b> , Pinze nasali	563
<b>KRISTELLER</b> , Speculum e valve vaginali	636
<b>KROENIG</b> , Abbassalingua	4
<b>KRONECKER</b> , Aghi per legature	262
<b>KÜHNE</b> , Pinzette	135
<b>KÜNTSCHER</b> , Chiodi	496
- Piegia chiodi	500

**L**

<b>LA FORCE</b> , Micro bisturi	589
<b>LA GRANGE</b> , Forbici chirurgiche	50, 80
<b>LAHEY</b> , Divaricatore	288
<b>LAMBERT-KAY</b> , Pinze vascolari	210
<b>LAMBOTTE</b> , Osteotomi	437
- Pinze ossivore	478
- Raspatori	404
<b>LANDAU</b> , Valve vaginali	637
<b>LANDOLT</b> , Manici per bisturi	34
- Pinze per biopsia	465
<b>LANE</b> , Giravite	528
- Pinza per chirurgia ossea	486
<b>LANGE</b> , Retrattore	289
<b>LANGENBECK</b> , Divaricatori	299
- Elevatore	395
- Port'aghi	259
- Raspatori	402
- Segna per osso	414
<b>LANGENBECK-RYDER</b> , Port'aghi	259
<b>LAWRENCE</b> , Pinze emostatiche e passafili	165
<b>LEES</b> , Pinze vascolari	209
<b>LEKSELL</b> , Pinze ossivore	470
<b>LELAND-JONES</b> , Pinze vascolari	215
<b>LEMPERT</b> , Pinze ossivore	468
<b>LERICHE</b> , Pinze emostatiche	151
<b>LEWIN</b> , Pinza riposizionatrice	479
<b>LEWIS</b> , Lime per osso	409
- Lime nasali	573
<b>LEXER</b> , Forbici chirurgiche	66, 95
- Osteotomi	446, 448
- Scalpelli	445, 446
<b>LEVIS</b> , Fonendoscopi	10
<b>LICHTENBERG</b> , Port'aghi	261
<b>LICHTWITZ</b> , Trokare	375
<b>LIEBERMANN-TENNANT</b> , Divaricatore oftalmico	598
<b>LINDEMANN</b> , Segna per osso	414
<b>LISTER</b> , Forbici per bendaggi	101
- Pinza emostatica	139
<b>LISTER-BURCH</b> , Blefarostati	599
<b>LISTON</b> , Pinze ossivore	473
<b>LISTON-STILLE</b> , Pinza ossivora	475
<b>LITTAUER</b> , Pinze auricolari	552
- Pinzette per cilia	135
<b>LITTLER</b> , Forbice delicata	59
<b>LITTLEWOOD</b> , Pinza uterina	644
<b>LOCHART</b> , Sonda	275
<b>LOCKLIN</b> , Forbici delicate	48, 53
<b>LÖFFEL</b> , Pinze a cucchiaio per rinologia	558
<b>LOGAN</b> , Divaricatore	327
<b>LORENZ</b> , Forbice da bendaggio	101
<b>LORNA</b> , Fissateli	147
<b>LOUTE</b> , Tendifilo per chirurgia ossea	499
<b>LOVE</b> , Divaricatori	289
<b>LOVE-GRUENWALD</b> , Pinze per biopsia	460, 461
<b>LUCAE</b> , Diaphason	5
- Martello chirurgico	429
- Pinzette chirurgiche	133
- Uncini per otologia	551
<b>LUER</b> , Pinza ossivora	467
<b>LUER-KÖRTE</b> , Curette uterine	651
<b>LUER-LOCK</b> , Manici porta-canule	681
<b>LUER-STILLE</b> , Pinze ossivore	469, 471, 472

**M**

<b>MAGILL</b> , Cannule per aspirazione	678
- Pinze da intubazione	7
<b>MAIER</b> , Pinze per tamponi	142, 633
<b>MALTZ</b> , Lima nasale	574
<b>MARKHAM-MEYERDING</b> , Divaricatori	336
<b>MARTIN</b> , Divaricatore	314
- Pinza per chirurgia ossea	485
- Porta cotone	277
- Isterometro	642
<b>MARTINI</b> , Cucchiari taglienti	416
<b>MASING</b> , Periostotomo	396
<b>MASSON</b> , Port'aghi	245, 257
<b>MATHIEU</b> , Divaricatori	290
- Divaricatore anale	369
- Port'aghi	248, 249, 260
- Valve vaginali	635
<b>MAYO</b> , Forbici chirurgiche	64, 65, 82, 96
- Isterometro malleabile	642
- Spatola	4
- Spilloni per sterilizzazione	697
<b>MAYO-HARRINGTON</b> , Forbici	75
<b>MAYO-HEGAR</b> , Port'aghi	244, 251, 252
<b>MAYO-HEGAR-HEANEY</b> , Port'aghi	256
<b>MAYO-LEXER</b> , Forbici chirurgiche	96
<b>MAYO-NOBLE</b> , Forbici chirurgiche	64
<b>MAYO-RUSSIAN</b> , Pinzette	125
<b>MAYO-STILLE</b> , Forbici	67, 94
<b>MC DONALD</b> , Periostotomo	397
<b>MC INTOSH</b> , Laringoscopi	11, 14, 16
<b>MC IVOR</b> , Apribocca	541
<b>MC KENTY</b> , Periostotomo	397
<b>MC KESSON</b> , Cannule per aspirazione	660
<b>MC PHERSON</b> , Micro pinzette	595, 596
<b>MEAD</b> , Periostotomo	395
- Martelli chirurgici	429
- Pinze ossivore	467
<b>MEEKER</b> , Pinze emostatiche e legature	165
<b>MELLINGER</b> , Blefarostati	599
<b>METZENBAUM</b> , Forbici	59, 60, 61, 81, 84, 89, 90, 91, 92, 99
<b>MEYERDING</b> , Divaricatori	312, 335
<b>MICHEL</b> , Pinze per agrafes	271
<b>MICRO-HALSTEAD</b> , Pinze emostatiche	149
<b>MICRO-HARTMANN</b> , Pinze per otologia	552
<b>MICRO-IRIS</b> , Forbici delicate	44
<b>MICRO-RYDER</b> , Port'aghi	258
<b>MICRO-VASCULAR</b> , Port'aghi	255
<b>MIDDLELDORPF</b> , Divaricatori	306
<b>MIKULICZ</b> , Divaricatori	322, 323
- Pinza emostatica	158
<b>MILLER</b> , Laringoscopi	12, 15, 16
- Lime per osso	408, 570
<b>MILLIGAN</b> , Elevatore	382
<b>MILLIN</b> , Divaricatori da prostata	369
<b>MINI-FRIEDMANN</b> , Pinze ossivore	466, 467
<b>MINI-GILLIES</b> , Port'aghi forbice	247, 253
<b>MINI-HOHMANN</b> , Elevatori	389
<b>MINI-LAMBOTTE</b> , Osteotomi	437, 438
<b>MINI-LEXER</b> , Osteotomi	440, 445
<b>MINI-OLSEN-HEGAR</b> , Port'aghi forbice	246
<b>MINI-ROUX</b> , Divaricatore	291
<b>MINNESOTA</b> , Divaricatore	539
<b>MISKIMON</b> , Divaricatori	340
<b>MIXTER</b> , Pinze emostatiche	162, 164
<b>MOLLISON</b> , Divaricatori	335
<b>MOLT</b> , Apribocca per bambini	537
- Periostotomo	401
<b>MORRIS-DE BAKEY</b> , Pinze vascolari	195
<b>MORSE</b> , Divaricatori costali	367
<b>MÜNCHEN</b> , Curette per biopsia	646
<b>MUSEUX</b> , Pinze uterine	644

**N**

<b>NEGUS</b> , Pinze emostatiche e legature	165
<b>NEGUS-GUEDEL</b> , Laringoscopi	13, 16
<b>NELATON</b> , Sonda	275



**NELSON**, Trokare 374  
**NELSON-METZENBAUM**, Forbici chirurgiche 62, 93  
**NEUBÜSER**, Pinzette per tube 645  
**NEUMANN**, Forbici angolate 50  
**NICOLA**, Micro pinze per rinologia 555  
**NOVAK**, Curette da aspirazione 646  
**NOYES**, Micro forbici 39, 601  
**NUBOER**, Cannule per aspirazione 666

**O**

**OBWEGESER**, Aghi per legature 489  
 - Divaricatori 302, 303, 545  
 - Osteotomi 437, 449, 450, 568  
 - Periostotomi 398, 399, 400  
**OCHSNER**, Pinza vascolare 205  
 - Tre quarti 374  
**OLDBERG**, Pinze per biopsia 465  
**OLIVECRONA**, Dissettori 383  
 - Pinza ossivora 469  
 - Spatole cerebrali 326  
**OLLIER**, Divaricatori 297  
**OLSEN-HEGAR**, Port'aghi con forbice 246, 253  
**OMBREDANNE**, Martello chirurgico 431  
**ORINGER**, Apribocca 538  
**OSHIKA-FAULKNER**, Micro pinzette oftalmiche 596  
**OVERHOLT**, Pinze per legature 161  
**OVERHOLT-GEISSENDORFER**, Pinze per legature 161

**P**

**PAPAVERO-CASPAR**, Speculum nasali 559  
**PAPAVERO-HARTMANN**, Speculum nasali 559  
**PARAMETRIUM**, Forbice chirurgica 97  
**PARKER-LANGENBECK**, Divaricatori 290  
**PARTSCH**, Osteotomi, scalpelli, sgorbie 435, 436  
**PATELLA**, Pinza riposizionatrice 481  
**PAYR**, Pinze per intestino 174  
 - Sonde conduttrici 269  
**PEAN**, Pinze emostatiche 150, 153, 156  
**PEAN-MURPHY**, Pinze emostatiche 140  
**PECK-JOSEPH**, Forbici chirurgiche 84  
**PEDERSON**, Speculum vaginali 634  
**PELTON-CRANE**, Cannule per aspirazione 679  
**PENFIELD**, Dissettori 385  
**PERRY**, Pinzette chirurgiche 115  
**PERTHES**, Perforatori a mano 490  
**PHILIPS**, Giravite universale 528  
**PIERCE**, Trokare 375  
**PIERSE**, Micro pinzette 594  
**PLESTER**, Cannule per aspirazione 669  
 - Divaricatori 333, 334  
**POOLE**, Cannule per aspirazione 675  
**POTTS**, Pinze vascolari 206, 208  
**POTTS-SMITH**, Forbici vascolari 73  
 - Pinzette chirurgiche 120, 131  
**POTTS-YASARGIL**, Micro forbici 40  
**POZZI**, Pinza uterina 643  
**PRATT**, Dilatatori uterini 640  
**PRICE-THOMAS**, Pinze vascolari 224  
**PROST**, Blearostati 599  
**PUTTI**, Lime per osso 413

**Q**

**QUINBY**, Forbici 46  
**QUINKE**, Aghi da biopsia 378, 684

**R**

**RADOLF**, Pinza per unghie 488  
**RAGNEL-DAVIS**, Divaricatore 288  
**RAMPLEY**, Pinze per tamponi 142, 633  
**RAMUS**, Pinze per chirurgia ossea 548  
**RANDALL**, Curette da aspirazione 646  
 - Pinze per calcoli renali 623

**RANKIN**, Pinze emostatiche 155  
**RECAMIER**, Curette uterine 653  
**REDON**, Aghi guida 270  
**REILL**, Micro port'aghi 610  
 - Pinza riposizionatrice 480  
**REVERDIN**, Spatola 326  
**REYNOLDS**, Forbici chirurgiche 51  
**RICARD**, Divaricatori 349  
**RICHARDSON**, Divaricatori 309  
**RICHARDSON-EASTMAN**, Divaricatori 309  
**ROBB**, Elevatori 384  
**ROBIN**, Fissateli 147  
**ROCHARD**, Divaricatori 363  
**ROCHESTER-CARMALT**, Pinze emostatiche 171  
**ROCHESTER-PEAN**, Pinze emostatiche 154, 162  
**RODHOIL**, Lubrificante per strumenti 687  
**ROGGE**, Pinze per sterilizzazione 696  
**ROSEN**, Aghi-cannula aspiranti 681  
**ROSER-KÖNIG**, Apribocca 6, 537  
**ROSS**, Divaricatori aortici 319  
**ROTAN**, Cannule per aspirazione 671  
**RÖTTGEN-RUSKIN**, Pinza ossivora 471  
**ROUX**, Divaricatori 291  
**ROUX-MAGNUS**, Divaricatori 291  
**ROWE**, Pinze riposizionatrici 550  
**RUBIN**, Pinze nasali 563  
**RUMEL**, Pinze emostatiche e passafilo 163  
**RUSKIN-STILLE**, Pinze ossivore 470  
**RUSKIN-LISTON**, Pinze ossivore 474  
**RUSSIAN**, Pinzette chirurgiche 125  
**RYDER**, Port'aghi 258  
**RYDEL-SEIFER**, Diaphason 5

**S**

**SACHS**, Elevatori 382  
**SALZBURG**, Periostotomi 396  
**SANDERS-BROWN**, Aghi per lagature 489  
**SANTULLI**, Bulldog clamps 180  
**SAROT**, Port'aghi 254  
**SATINSKY**, Forbice 69  
 - Pinze vascolari 225  
**SAUERBRUCH**, Costotomi 477  
 - Divaricatori 301, 315  
 - Pinza ossivora 472  
 - Pinze per sterilizzazione 697  
**SAUERBRUCH-FREY**, Costotomo 477  
**SAUG-RASPATORIUM**, Cannule per aspirazione 667  
**SCHAEDEL**, Fissateli 146  
**SCHEDE**, Cucchiari taglienti 419  
**SCHLESINGER**, Laminotomi cervicali 456  
**SCHMID**, Aghi vascolari malleabili 228, 681  
**SCHMIEDEN**, Aghi per legature 267  
**SCHMIEDEN-DICK**, Aghi per legature 267  
**SCHMIEDEN-TAYLOR**, Forbici chirurgiche 70  
**SCHNEIDER**, Raspatore 402  
**SCHRÖDER**, Cucchiari taglienti 424  
 - Pinza uterina 643  
**SCHUBERT**, Pinze per biopsia 649  
**SCHUMACHER**, Elevatori 392  
 - Costotomo 477  
 - Pinze per biopsia 650  
**SCOVILLE**, Divaricatore 292, 350, 351  
**SCOVILLE-HAVERFIELD**, Divaricatore 350  
**SEDILLOT**, Periostotomo 397  
 - Raspatore 402  
**SELDIN**, Periostotomo 395  
**SELMAN**, Pinzette emostatiche 125  
**SEMB**, Raschiatori 403  
**SEMKEN**, Pinzette chirurgiche 115, 120, 130  
**SENN-GREEN**, Divaricatori 287  
**SENN-MILLER**, Divaricatori 288  
**SEPTUN-NADEL**, Aghi-cannula angolati 680  
**SHAPLEIGH**, Curette per otologia 551  
**SIEBENMANN**, Cannule per aspirazione 677  
**SIEBOLD**, Forbici chirurgiche 78  
**SIGMOID-NOTCH**, Periostotomi-Divaricatori 388, 547  
**SILVER**, Scalpelli nasali 566  
**SIMON**, Cucchiari taglienti 424



- Divaricatori	314
<b>SIMPSON</b> , Isterometri	642
<b>SIMPSON-BRAUN</b> , Forcipe uterino	656
<b>SIMS</b> , Forbici chirurgiche	75, 76, 98
- Isterometri	642
<b>SINGLEY-TUTTLE</b> , Pinzette anatomiche	125
<b>SMITH</b> , Forbici per fili metallici	102
<b>SMITH-BUIE</b> , Divaricatori	370
<b>SMITH-PETERSEN</b> , Osteotomi	442
<b>SNELLEN</b> , Anse per oftalmologia	591
<b>SPENCER</b> , Forbici togliapunti	100
<b>SPLIT</b> , Osteotomi curvi	578
<b>SPURLING</b> , Pinze per biopsia	461
<b>STACKE</b> , Sonda bottonuta	276
<b>STAMMBERGER</b> , Pinze per rinologia	556
<b>STEINHÄUSER</b> , Periototomi	400
<b>STEINMANN</b> , Chiodi filettati	496, 497
<b>STELLBRINK</b> , Pinze ossivora	466
<b>STERNBERG</b> , Divaricatori	290, 539
<b>STEVENS</b> , Forbici delicate	51
- Port'aghi	242
<b>STIEGLITZ</b> , Pinze per frammenti	134
<b>STILLE</b> , Forbici chirurgiche	67
- Osteotomi, Scalpelli	441
- Pinza ossivora	471
- Pinzette chirurgiche	118
- Pinze per gesso	533
- Pinze renali	175
- Port'aghi	249
- Pinze renali	629
- Scalpelli	441
<b>STILLE-BARRAYA</b> , Pinzette chirurgiche	124
<b>STRULLY</b> , Forbici chirurgiche	69
<b>STRUYCKEN</b> , Pinza per rinologia	556
<b>SUBRAMANIAN</b> , Pinze vascolari	221
<b>SUBRAMANIAN-MINIATURE</b> , Pinze vascolari	221
<b>SWEDESH mod.</b> , Port'aghi	254
<b>SYPERT</b> , Battitore	433
- Pinze per biopsia	464

**T**

<b>TAKAHASHI</b> , Pinze per biopsia	460
<b>TAYLOR</b> , Divaricatori	351
- Elevatori	394
- Martello percussore	3
- Pinzette chirurgiche	131
<b>TERRIER</b> , Pinza emostatica	139
<b>TESSIER</b> , Cucchiali taglienti	425, 583
- Divaricatori	313, 545
- Osteotomi	443, 583
- Pinze per osso	585
- Pinza palatale	549
<b>THOMS-GAYLOR</b> , Pinze per biopsia	647
<b>TISCHLER-MORGAN</b> , Pinza per biopsia	650
<b>TOBOLD</b> , Abbassalingua	544
<b>TÖNNIS</b> , Forbici chirurgiche	63
- Port'aghi	247, 259
<b>TÖNNIS-ADSON</b> , Forbici chirurgiche	63, 97
<b>TÖNNIS-RYDER</b> , Port'aghi	259
<b>TROELTSCH</b> , Pinzette anatomiche	133
<b>TROEMNER</b> , Martelli percussori	3
<b>TROUTMAN</b> , Micro pinzette oftalmiche	596
- Micro forbici oftalmiche	603
<b>TUBBS</b> , Dilatatori	229
<b>TUFFIER</b> , Divaricatore costale	367
- Spatola malleabile	326
<b>TUOHY</b> , Aghi da biopsia	378, 684

**U**

<b>UFFENORDE</b> , Cucchiali taglienti	418
<b>ULRICH</b> , Pinze per fissazione ossea	484
<b>UNIVERSAL</b> , Porta cotone	277
- Trokare	376
<b>URO-TANGENTIAL</b> , Pinze vascolari	220

**V**

<b>VALLEIX</b> , Isterometro	642
<b>VAN DOREN</b> , Pinze per biopsia	648
<b>VANNAS</b> , Micro forbici	39, 43
<b>VARADAY</b> , Strumenti per vene varicose	228
<b>VERBRUGGE</b> , Pinze per osso	482
<b>VERES</b> , Aghi per biopsia	684
<b>WISE</b> , Micro pinzette	107
<b>VOLKMANN</b> , Cucchiali taglienti	417, 420
- Divaricatori	294, 295
<b>VOLLMAR</b> , Stripper	228

**W**

<b>WAGNER</b> , Piegia chiodi	500
- Pinze per biopsia	464
<b>WALDMANN</b> , Forbice per episiotomia	79
<b>WALLICH</b> , Curette uterine	652
<b>WALTON</b> , Divaricatori	336
<b>WALTON-POOLE</b> , Cannula per aspirazione	675
<b>WANGENSTEEN</b> , Pinzette chirurgiche	131
- Port'aghi	245, 252
<b>WASSMUND</b> , Divaricatore	299
<b>WEBER</b> , Anse per oftalmologia	591
- Pinze vascolari	204
<b>WEBSTER</b> , Port'aghi	250
<b>WECKER</b> , Micro spatole	590
- Micro forbici	600
<b>WEIL-BLAKESLEY</b> , Pinze per biopsia	459
<b>WEITLANER</b> , Divaricatori	330, 331, 332, 338
<b>WELLER</b> , Forbici chirurgiche	78
<b>WERTHEIM</b> , Forbice chirurgiche	58, 98
- Pinze renali	176, 630, 631
- Port'aghi	256
<b>WEST</b> , Periototomo	395
<b>WESTCOTT</b> , Micro forbici	39, 601
<b>WHERTEIMER</b> , Cannule per aspirazione	674
<b>WHITEHEAD-JENNINGS</b> , Apribocca	6, 540
<b>WIEDER</b> , Abbassalingua	544
<b>WIKSTROEM</b> , Pinze per legature	164
<b>WILDE</b> , Strumento per tonsille	562
<b>WILDER</b> , Dilatatori lacrimali	592
<b>WILLIAMS</b> , Blefarostati	599
<b>WILLIGER</b> , Cucchiali taglienti	416, 422
- Elevatori	381
- Martello chirurgico	429
<b>WINTER</b> , Pinza da placenta e aborto	632
<b>WOLFF</b> , Pinze per gesso	532
<b>WULLSTEIN</b> , Cannule per aspirazione	665, 681
- Divaricatori	330
- Micro cucchiaino ovale	554

**Y**

<b>YANKAUER</b> , Cannule per aspirazione	662
<b>YASARGIL</b> , Cannule per aspirazione	668
- Micro Forbici	40, 43
- Pinze per biopsia	465
- Micro Pinzette	110
- Port'aghi	236, 237
<b>YASARGIL-NICOLA</b> , Micro pinza per rinologia	555
<b>YOUNG</b> , Pinza tiralingua	8, 143

**Z**

<b>ZAUFAL-JANSEN</b> , Pinza ossivora	470
<b>ZIEGLER</b> , Micro bisturi	27, 589
<b>ZIELINSKY</b> , Compasso da misurazione	22
<b>ZIELKE</b> , Osteotomo	448

**A**

<b>ADLERKREUTZ</b> , Tissue forceps	124
<b>ADSON</b> , Suction tubes	674
- Retractors	338, 339, 341, 343
- Periosteal	401
- Tissue forceps	116, 130
<b>ADSON-BROWN</b> , Tissue forceps	116
<b>ALAN-PARKS</b> , Retractors	370
<b>ALDERDYCE</b> , Elevators	395
<b>ALEXANDER</b> , Bone cutting forceps	468
- Biopsy specimen forceps	649
<b>ALLIS</b> , Gum and Tissue forceps	145, 223
<b>ALLISON</b> , Retractors	318
<b>ALM</b> , Retractors	327
<b>ANDERSON-ADSON</b> , Retractors	335
<b>ANDREWS-PYNCHON</b> , Suction tubes	662
<b>ANEL</b> , Eye instruments	593
<b>ANGLE</b> , Wire cutting pliers	510
<b>ARKANSAS</b> , Accessories for re-sharpening	688
<b>ARRUGA</b> , Needle holders	261
- Eye instruments	592
<b>ASH</b> , Rhinology	563
<b>AUFRICHT</b> , Rhinology	565
- Bone files	409
<b>AUSTIN</b> , Tissue forceps	115

**B**

<b>BABBUSH</b> , Elevators	395
<b>BABCOCK</b> , Intestinal forceps	144, 223
- Double probe malleable	680
<b>BABINSKY</b> , Percussion hammer	3
<b>BABY-ADSON</b> , Artery forceps and ligature	160
<b>BABY-ALLIS</b> , Gum and tissue forceps	145
<b>BABY-CRILE</b> , Hemostatic forceps	152
<b>BABY-CRILE-WOOD</b> , Needle holders	250
<b>BABY-COLLIN</b> , Retractors	346
<b>BABY-FINOCCHIETTO</b> , Retractors	365
<b>BABY-METZENBAUM</b> , Operating scissors	59
<b>BABY-MIXTER</b> , Hemostatic forceps	160
<b>BABY-MORSE</b> , Rib spreaders	367
<b>BABY-WEITLANER</b> , Retractors	330
<b>BABY-YANKAUER</b> , Suction tubes	662
<b>BACKHAUS</b> , Towel clamps	146
<b>BAILEY</b> , Rib spreaders	368
<b>BAINBRIDGE</b> , Intestinal forceps	166
<b>BAKES</b> , Gall duct dilators	625
<b>BALFOUR</b> , Abdominal retractors	358, 359, 360
<b>BALFOUR-BABY</b> , Abdominal retractors	358
<b>BALLENGER</b> , Rhinology	569
- Rhinology	565
<b>BARON</b> , Suction tubes	670
<b>BARR</b> , Anal retractors	370
<b>BARRAQUER</b> , Eye specula	598
- Micro Forceps	595
- Micro Needle holders	609, 610, 611
- Forceps	135
- Needle holders	234
<b>BARTH</b> , Sharp curettes	416
<b>BAUMGARTNER</b> , Needle holders for ligature	511
<b>BEACHAM</b> , Uterine amniotome	643
<b>BECK</b> , Vessel clamps	207
<b>BECKMANN</b> , Adenotomie	576
- Retractors	342
<b>BECKMANN-EATON</b> , Retractors	343
<b>BEEBE</b> , Wire and plate cutting scissors	103
<b>BEER</b> , Cilia forceps	135
<b>BELLUCCI</b> , Suction tubes	670
- Micro scissors	554
<b>BENGOLEA</b> , Hemostatic forceps	159
<b>BENIQUE</b> , Catheters	624
<b>BENNET</b> , Elevators	393
<b>BERGH</b> , Cilia forceps	135
<b>BERGMANN</b> , Surgical mallets	430
<b>BERNHARD</b> , Gum and Tissue forceps	148
<b>BEYER</b> , Bone rongeurs	470
<b>BILLEAU</b> , Ear loops anses	551

<b>BIRKETT</b> , Hemostatic forceps	158
<b>BLAKE</b> , Uterine curettes	652
<b>BLOHMKE</b> , Intestinal forceps	174
<b>BLOUNT</b> , Elevator	389, 393
<b>BLUMENTHAL</b> , Bone rongeurs	467
<b>BÖHLER</b> , Bone cutting forceps	474
<b>BONNEY</b> , Tissue forceps	131
<b>BOWLED-HENRY</b> , Retractors	311
<b>BOWMAN</b> , Probes	276
<b>BOYNTON</b> , Needle holders	249, 261
<b>BRAUN</b> , Operating scissors	
- Uterine forceps	629
<b>BRAUN-STADLER</b> , Operating scissors	77
<b>BREISKY</b> , Vaginal specula	638
<b>BROCK</b> , Scissors	41
- Forceps	109
- Needle holders	233
<b>BROWN</b> , Tissue forceps	125
<b>BRUENINGS</b> , Tongue depressor	4
<b>BRUNNER</b> , Wire guides	268, 505
- Costotome	477
<b>BRUNS</b> , Sharp curettes	419
- Bandage scissors	101
<b>BUCHWALD</b> , Tongue depressor	4
<b>BÜCHS</b> , Retractors	311
<b>BUCK</b> , Percussion hammer	3
<b>BUCK-GRAMCKO</b> , Elevator	389
<b>BUCKLEY</b> , Osteotome	434
<b>BUELAU</b> , Trocars	377
<b>BUMM</b> , Uterine curettes	654, 655
<b>BUNT</b> , Sterilizing instruments	697
<b>BUSHE</b> , Sharp curettes	423

**C**

<b>CAPLAN</b> , Rhinology	564
<b>CASPAR</b> , Sharp curettes	425
- Retractors	304, 352, 353
- Lamina spreaders	354, 355
- Measuring instruments	22
- Osteotome	433
- Biopsy forceps	462, 463
<b>CASTANEDA</b> , Atraumatic vessel clamps	182
<b>CASTROVIEJO</b> , Eye specula	599
- Micro Retractors	591
- Micro scissors	603
- Micro forceps	596
- Eye instruments	592
- Needle holders	238, 239, 240, 241, 242
- Measuring instruments	19, 20, 21
<b>CHADWICK</b> , Delicate scissors	46
<b>CHARNELY</b> , Retractors	364
<b>CHEATTLE</b> , Sterilizing forceps	697
<b>CHILD</b> , Tongue forceps	8, 143
<b>CINELLI</b> , Rhinology	567
<b>CITELLI</b> , Bone cutting forceps	453
<b>CLEANLACT</b> , Soluble lubricant for surgical instruments	687
<b>CLOWARD</b> , Retractors	345
- Lamina spreaders	356
<b>CLOWARD-CONTOUR</b> , Retractors	329
<b>COAKLEY</b> , Sharp curettes	575
<b>COBB</b> , Raspatories	407
<b>COLIBRI</b> , Micro forceps	594
<b>COLLIN</b> , Costotome	475
- Retractors	346, 347, 348
- Hemostatic forceps	139, 143, 633
- Tongue forceps	7
- Clip applying forceps	271
- Sterilizing forceps	697
- Amputations	414
<b>COLLIN-Standard</b> , Vaginal specula	634
<b>CONVERSE</b> , Retractors	288
- Needle holders	250
- Tenotome	28
<b>COOLEY</b> , Dilator for mitral valve	229
- Rib spreaders	324, 366
- Atraumatic vessel clamps	212, 213, 214, 215, 216
<b>COOPER</b> , Ligature needles	267
<b>COOK</b> , Eye specula	599



<b>CORYLLOS</b> , Retractors	315
<b>COTTLE</b> , Retractors	284
- Elevators	396
- Delicate scissors	71
- Bone files	409
- Surgical mallets	430
- Osteotome	438, 579
- Atraumatic Tissue forceps	129
- Nasal Raspatories-Elevator	565
- Nasal specula	559
- Bone crusher	564
<b>COTTLE-MASING</b> , Delicate scissors	46
<b>COTTLE-NEIVERT</b> , Double Retractors	565
<b>COTTLE-WALSHAM</b> , Nasal forceps	563
<b>COUPLAND</b> , Suction tubes	664, 665
<b>CRAFOORD</b> , Ligature forceps	163
<b>CRILE</b> , Hemostatic forceps	151, 152
<b>CRILE-WOOD</b> , Needle holders	243, 250, 252
<b>CRILE-MURRAY</b> , Needle holders	243
<b>CUSCO</b> , Vaginal specula	634
<b>CUSHING</b> , Retractors	288, 289, 292
- Periostotome	401
- Biopsy forceps	461
- Bone cutting forceps	469
- Forceps	121, 131
- Spatulas malleable	326
<b>CUSHING-KOCHER</b> , Retractors	292

**D**

<b>DALE</b> , Atraumatic vessel clamps	217
<b>DANDY</b> , Delicate scissors	70
- Tissue forceps	151
- Hemostatic forceps	151
<b>DAUBENSPECK</b> , Sharp curettes	423
<b>DAUTREY-MUNRO</b> , Osteotome	581
<b>DAVIDSON</b> , Retractors	316
<b>DAVIS</b> , Elevator	382
- Sterilizing forceps	696
<b>DAVIS-BOYLE</b> , Mouth gags	541
<b>DAY</b> , Otology instruments	551
<b>DE BAKEY</b> , Suction tubes	664
- Vascular dilator	226
- Scissors	73
- Needle holders	255
<b>DE BAKEY-BAHNSON</b> , Atraumatic vessel clamps	193
<b>DE BAKEY-BAINBRIDGE</b> , Atraumatic vessel clamps	187
<b>DE BAKEY-CAROTIS</b> , Atraumatic vessel clamps	180
<b>DE BAKEY-MOSQUITO</b> , Atraumatic vessel clamps	185
<b>DE BAKEY-HARKEN</b> , Atraumatic vessel clamps	200
<b>DE BAKEY-PEAN</b> , Atraumatic vessel clamps	186
<b>DE BAKEY (POTTS-SMITH)</b> , Scissors	73
- Forceps	126, 127, 128, 132
- Atraumatic vessel clamps	183, 203
<b>DE BAKEY-RANKIN</b> , Atraumatic vessel clamps	185
<b>DE BAKEY-SATINSKY</b> , Atraumatic vessel clamps	180, 198
<b>DEAN</b> , Serrated scissors	70
<b>DEAVER</b> , Operating scissors	57
- Retractors	320, 321
<b>DEJERINE</b> , Percussion mallets	3
<b>DEMEL</b> , Wire guides	504
<b>DENIS-BROWN</b> , Retractors	362
<b>DERF</b> , Needle holders	243, 250
<b>DERRA</b> , Atraumatic vessel clamps	189
<b>DESCHAMPS</b> , Ligature needle	262, 263, 264, 265, 266
<b>DESJARDINS</b> , Kidney stone dilator	623
- Gall duct dilators	628
<b>DESMARRES</b> , Knives	28
- Retractors	287
- Forceps	129
<b>DIETER</b> , Ear instruments	554
<b>DIETRICH</b> , Scissors	74
- Atraumatic vessel clamps	205
- Micro needle holders	240
<b>DIFFENBACH</b> , Bulldog clamps	177
<b>DIXON-LOVELACE</b> , Hemostatic forceps	158
<b>DINGMANN</b> , Mouth gags	542
- Bone surgery	485
<b>DITTEL</b> , Gall duct dilators	626

<b>DOCKHORN</b> , Retractors	305
<b>DOLWICK-REICH</b> , Retractors	337
<b>DOYEN</b> , Towel clamps	146
- Retractor	308, 363
- Atraumatic forceps	171
- Raspatories	404
- Probes	275
- Myom instruments	645
- Vaginal specula	637
<b>DOYEN-COLLIN</b> , Mouth gags	6, 537
<b>DOYEN-JANSEN</b> , Mouth gags	6, 537
<b>DOYEN-STILLE</b> , Retractors	308
<b>DUBOIS</b> , Operating scissors	77
<b>DUKE</b> , Trocars	377
<b>DUNN-DAUTREY</b> , Retractors	546
<b>DUPLAY</b> , Otology specula	18
<b>DUPUY-WEISSE</b> , Ligature needle	262
<b>DURANTE</b> , Forceps	125
<b>DUVAL</b> , Tissue forceps	129
- Atraumatic vessel clamps	223
- Hemostatic forceps	145, 629
<b>DUVAL-COLLIN</b> , Intestinal forceps	629

**E**

<b>ECHLIN</b> , Bone cutting forceps	470
<b>EDER</b> , Cotton applicators	279
<b>EISELBERG-MATHIEU</b> , Needle holders	249
<b>ELLIS</b> , Micro Knives	589
<b>EPKER</b> , Osteotome	578
<b>ESMARCH</b> , Bandage scissors	101

**F**

<b>FAGER</b> , Elevator	382
<b>FAHLBUSCH</b> , Micro Scissors for Rhinology	555
<b>FARABEUF</b> , Retractors	290
- Bone cutting forceps	478
- Raspatories	402
<b>FARABEUF-LAMBOTTE</b> , Bone cutting forceps	478
<b>FARREL</b> , Cotton applicators	277
<b>FAULKNER</b> , Eye instruments	596
<b>FAURE</b> , Towel clamps	146
- Biopsy forceps	648
<b>FEICHENFELD</b> , Tissue forceps	134
<b>FEIN</b> , Cotton applicators	278
<b>FENO</b> , Vaginal specula	656
<b>FERGUSSON</b> , Suction tubes	669
- Angiotribe forceps	166
<b>FERRIS-SMITH-KERRISON</b> , Laminectomy	454, 455, 456, 457
<b>FERRIS-SMITH-CUSHING</b> , Laminectomy	458
<b>FIBULA</b> , Bone cutting forceps	479
<b>FINOCCHIETTO</b> , Retractors	365
- Needle holders	257
<b>FINSEN</b> , Retractors	327
<b>FINSTERER</b> , Suction tubes	664
<b>FOERSTER-BALLENGER</b> , Sponge and dressing forceps	141
<b>FOMON</b> , Retractors	284
- Angolate scissors	59, 70, 71
- Bone files	410, 412, 572
- Rhinology	567
<b>FRANKFELDT</b> , Cotton applicators	279
<b>FRAZIER</b> , Suction tubes	669, 674, 680
- Retractors	350
<b>FREER</b> , Elevators	395
- Gouges	434
- Mucous knife	572
<b>FRENZEL</b> , Tongue forceps	4
<b>FRIEDMANN</b> , Bone rongeurs	467

**G**

<b>GABON</b> , Bone cutters	586
<b>GALLAHER</b> , Bone files	408
<b>GARRETT</b> , Vascular dilator	227
<b>GELLHORN</b> , Biopsy forceps	647
<b>GELPI</b> , Retractors	328



**GELPI-LOKTITE**, Retractors 329  
**GELPI-SEILETZ**, Retractors 329  
**GEMINI**, Artery forceps and ligature 162  
**GENTOFT**, Vaginal specula 656  
**GERALD**, Tissue forceps 123  
**GERALD-BROWN**, Tissue forceps 123  
**GERSTER**, Bone surgery 487  
**GERSTER-LOWMAN**, Bone surgery 487  
**GIDEF**, Hemostatic forceps 150  
**GIERTZ-STILLE**, Costotome 477  
**GIGLI**, Amputation 414  
**GIL-VERNET**, Retractors 293  
**GILLIES**, Retractors 283  
 - Needle holders 247, 253  
**GLASSMAN**, Operating scissors 52  
**GLOVER**, Bulldog clamps 179, 180  
 - Vascular forceps 207  
**GOLDMAN-FOX**, Operating scissors 49, 50, 80, 84  
**GOELET**, Retractors 291  
**GORNEY**, Operating scissors 68  
 - Suction tubes 667  
**GOSSET**, Abdominal Retractors 357  
**GOURDET**, Uterine curettes 651  
**GRAEFE**, Delicate scissors 46  
 - Tissue forceps 114, 129  
 - Micro Retractors 589, 590  
 - Micro Knife 27, 590  
**GRAY**, Ligature forceps 164  
**GRAVE**, Vaginal specula 634  
**GREGORY**, Vascular forceps 207  
**GREENE**, Retractors 311  
**GROSS**, Hemostatic forceps 139, 141  
**GRUENWALD**, Tissue forceps 133  
**GUILLIEN**, Suction tubes 667  
**GUSBERG**, Endocervical Biopsy curettes 646  
**GUTHRIE**, Retractors 283  
**GUYON**, Gall duct dilator 628  
 - Catheters 624  
 - Kidney pedicle clamps forceps 175  
 - Uterine forceps 629

## H

**HABERER**, Spatulas malleable 326  
**HAGLUND**, Plaster cast breakers 533  
**HALLE**, Sharp curettes 422  
**HALSEY**, Needle holders 243, 250  
**HALSTED**, Hemostatic forceps 150, 152  
**HALSTED-MOSQUITO**, Hemostatic forceps 149, 152  
**HANK**, Uterine dilators 641  
**HARRINGTON**, Retractors 317  
**HARTMANN**, Tongue forceps 544  
 - Suction tubes 676, 677  
 - Tuning Forks 5  
 - Cotton applicators 278  
 - Bone cutting forceps 469  
 - Ear forceps 552, 553  
 - Nasal specula 18, 560, 561  
**HARTMANN-BABY-MOSQUITO**, Hemostatic forceps 149  
**HAYES**, Atraumatic vessel clamps 218  
**HEANEY**, Needle holders 257  
**HEANEY-HEGAR**, Needle holders 244  
**HEAT**, Surgical mallets 431  
**HEGAR**, Uterine dilators 639, 641  
 - Needle holders 244, 251  
**HEGAR-MAYO-SEELEY**, Needle holders 245, 252  
**HEGENBARTH**, Tissue forceps 271  
**HEILDELBERG**, Cotton applicators 278  
**HEISS**, Hemostatic forceps 158  
**HEISTER**, Mouth gags 6, 537  
**HEMINGWAY**, Sharp curettes 415  
**HENAHAN**, Periostotomes 401  
**HENLEY**, Retractors 344  
**HENNIG**, Plaster cast breakers 533  
**HEPARIN**, Needle malleable 682  
**HEYMANN**, Angolate scissors 71  
**HEYMANN-KNIGHT**, Angolate scissor 71  
**HIBBS**, Retractors 297  
 - Osteotomes 439

**HOHMANN**, Elevators 391, 394  
**HOLZBACH**, Retractors 349  
**HÖPFNER**, Intestinal forceps 174  
**HOPT**, Vascular forceps 219  
**HOUSE**, Suction tubes 672  
**HOWARD**, Bone files 408, 570  
**HOWARTH**, Periostotomes 397  
**HUNTER**, Splinter forceps 134  
**HURD**, Periostotomes 397

## I

**INGE**, Lamina spreaders 356  
**IRIS**, Delicate scissors 44, 81, 83, 84, 99  
**ISRAEL**, Retractors 298  
**ITARD**, Suction tubes 677

## J

**JACKSON-TESSIER**, Bone cutting scissors 476  
**JACOBSON**, Sharp curettes 416  
 - Micro scissors 40  
 - Drilling Chucks 501, 502, 503, 527  
 - Needle holders 235, 241  
**JACOBSON-UNIVERSAL**, Drilling Chucks 527  
**JAMESON**, Delicate scissors 47  
**JAMESON-WERBER**, Delicate scissors 47  
**JANSEN**, Sharp curettes 416  
 - Retractors 327  
 - Bone cutting forceps 469  
 - Forceps 133  
 - Raspatories 402  
**JANSEN-LEUER**, Bone cutting forceps 468  
**JAVID**, Vascular forceps 222  
**JONES**, Towel clamps 146  
 - Hemostatic forceps 139  
**JOSEPH**, Retractors 284  
 - Scissors 58  
 - Bone files 408  
 - Rhinology 573, 574  
 - Periostotomes 401  
**JUDD-MASSON**, Bladder Retractors 369

## K

**KALLMORGEN**, Vaginal specula 635  
**KELLY**, Retractors 310  
 - Operating scissors 53, 85  
 - Hemostatic forceps 155  
**KERN**, Bone cutting forceps 486  
**KERPEL**, Sharp curettes 418  
**KERSHNER**, Eye instruments 598  
**KERRISON**, Laminectomy 453  
**KERRISON-JACOBY**, Laminectomy 455  
**KEVORKIAN**, Biopsy forceps 650  
**KEY-HORSLEY**, Bone cutting forceps 475  
**KEYES**, Dermal punches 28, 491  
**KILLIAN**, Suction tubes 678  
 - Nasal scissors 72  
 - Rhinology 564  
 - Rhinology 565  
 - Nasal specula 560, 561  
**KILLIAN-KLAUS**, Osteotomes 565  
**KILNER**, Scissors 47, 52, 85  
 - Needle holders 256  
**KILNER-DOUGHTY**, Mouth gags 540  
**KIMURA**, Micro spatulas 592  
**KIRSCH**, Retractors 304  
**KIRSCHNER**, Retractors 361  
**KLIMA-ROSEGGER**, Biopsy needle 377  
**KOCHER**, Ligature needle 267  
 - Retractors 292, 294, 296, 301, 305, 307  
 - Hemostatic forceps 153, 155, 157  
 - Intestinal forceps 172, 173  
 - Conductor probes 269  
**KOCHER-LANGENBECK**, Retractors 300  
**KOCHER-OCHSNER**, Tissue forceps 154



<b>KOENIG</b> , Conductor probe	269
<b>KOERTE</b> , Retractor	323
<b>KÖNIG</b> , Elevator	381
<b>KRAUSE</b> , Ear polypus snares	562
- Trocars	375
<b>KRESSNER</b> , Nasal forceps	563
<b>KRISTELLER</b> , Vaginal specula	636
<b>KROENIG</b> , Tongue forceps	4
<b>KRONECKER</b> , Ligature needle	262
<b>KÜHNE</b> , Forceps	135
<b>KÜNTSCHER</b> , Wires	496
- Bone surgery	500

**L**

<b>LA FORCE</b> , Micro knives	589
<b>LA GRANGE</b> , Operating scissors	50, 80
<b>LAHEY</b> , Retractors	288
<b>LAMBERT-KAY</b> , Vascular forceps	210
<b>LAMBOTTE</b> , Osteotomes	437
- Bone cutting forceps	478
- Raspatories	404
<b>LANDAU</b> , Vaginal specula	637
<b>LANDOLT</b> , Scalpel handles	34
- Biopsy forceps	465
<b>LANE</b> , Screw drivers	528
- Bone cutting forceps	486
<b>LANGE</b> , Retractors	289
<b>LANGENBECK</b> , Needle holders	259
- Retractors	299
- Elevator	395
- Raspatories	402
- Amputations	414
<b>LANGENBECK-RYDER</b> , Needle holders	259
<b>LAWRENCE</b> , Artery forceps and ligature	165
<b>LEES</b> , Vascular forceps	209
<b>LEKSELL</b> , Bone cutting forceps	470
<b>LELAND-JONES</b> , Vascular forceps	215
<b>LEMPERT</b> , Bone cutting forceps	468
<b>LERICHE</b> , Hemostatic forceps	151
<b>LEWIN</b> , Bone surgery	479
<b>LEWIS</b> , Bone files	409
- Rhinology	573
<b>LEXER</b> , Operating scissors	66, 95
- Osteotomes	446, 448
- Gouges	445, 446
<b>LEVIS</b> , Stethoscopes	10
<b>LICHTENBERG</b> , Needle holders	261
<b>LICHTWITZ</b> , Trocars	375
<b>LIEBERMANN-TENNANT</b> , Eye instruments	598
<b>LINDEMANN</b> , Amputations	414
<b>LISTER</b> , Bandage scissors	101
- Hemostatic forceps	139
<b>LISTER-BURCH</b> , Eye specula	599
<b>LISTON</b> , Bone cutting forceps	473
<b>LISTON-STILLE</b> , Bone cutting forceps	475
<b>LITTAUER</b> , Ear forceps	552
- Cilia forceps	135
<b>LITTLER</b> , Delicate scissors	59
<b>LITTLEWOOD</b> , Uterine forceps	644
<b>LOCHART</b> , Probes	275
<b>LOCKLIN</b> , Delicate scissors	48, 53
<b>LÖFFEL</b> , Rhinology	558
<b>LOGAN</b> , Retractors	327
<b>LORENZ</b> , Bandage scissors	101
<b>LORNA</b> , Towel clamps	147
<b>LOUTE</b> , Bone wire tighteners	499
<b>LOVE</b> , Retractors	289
<b>LOVE-GRUENWALD</b> , Biopsy forceps	460, 461
<b>LUCAE</b> , Tuning forks	5
- Surgical mallets	429
- Tissue forceps	133
- Otology instruments	551
<b>LUER</b> , Bone cutting forceps	467
<b>LUER-KÖRTE</b> , Uterine curettes	651
<b>LUER-LOCK</b> , Suction tubes handle	681
<b>LUER-STILLE</b> , Bone cutting forceps	469, 471, 472

**M**

<b>MAGILL</b> , Suction tubes	678
- Catheter introducing forceps	7
<b>MAIER</b> , Sponge and dressing forceps	142, 633
<b>MALTZ</b> , Rhinology	574
<b>MARKHAM-MEYERDING</b> , Retractors	336
<b>MARTIN</b> , Retractor	314
- Bone cutting forceps	485
- Cotton applicators	277
- Uterine sounds	642
<b>MARTINI</b> , Sharp curettes	416
<b>MASING</b> , Elevators	396
<b>MASSON</b> , Needle holders	245, 257
<b>MATHIEU</b> , Retractors	290
- Anal Retractors	369
- Needle holders	248, 249, 260
- Vaginal specula	635
<b>MAYO</b> , Operating scissors	64, 65, 82, 96
- Uterine sounds malleable	642
- Spatulas	4
- Sterilizing forceps	697
<b>MAYO-HARRINGTON</b> , Scissors	75
<b>MAYO-HEGAR</b> , Needle holders	244, 251, 252
<b>MAYO-HEGAR-HEANEY</b> , Needle holders	256
<b>MAYO-LEXER</b> , Operating scissors	96
<b>MAYO-NOBLE</b> , Operating scissors	64
<b>MAYO-RUSSIAN</b> , Forceps	125
<b>MAYO-STILLE</b> , Scissors	67, 94
<b>MC DONALD</b> , Elevator	397
<b>MC INTOSH</b> , Laryngoscopes	11, 14, 16
<b>MC IVOR</b> , Mouth gags	541
<b>MC KENTY</b> , Elevator	397
<b>MC KESSON</b> , Suction tubes	660
<b>MC PHERSON</b> , Micro forceps	595, 596
<b>MEAD</b> , Elevator	395
- Surgical mallets	429
- Bone cutting forceps	467
<b>MEEKER</b> , H emostatic forceps and ligature	165
<b>MELLINGER</b> , Eye specula	599
<b>METZENBAUM</b> , Scissors	59, 60, 61, 81, 84, 89, 90, 91, 92, 99
<b>MEYERDING</b> , Retractors	312, 335
<b>MICHEL</b> , Clip applying forceps	271
<b>MICRO-HALSTEAD</b> , Hemostatic forceps	149
<b>MICRO-HARTMANN</b> , Otology forceps	552
<b>MICRO-IRIS</b> , Delicate scissors	44
<b>MICRO-RYDER</b> , Needle holders	258
<b>MICRO-VASCULAR</b> , Needle holders	255
<b>MIDDLELDORPF</b> , Retractors	306
<b>MIKULICZ</b> , Retractors	322, 323
- Hemostatic forceps	158
<b>MILLER</b> , Laryngoscopes	12, 15, 16
- Bone files	408, 570
<b>MILLIGAN</b> , Elevator	382
<b>MILLIN</b> , Bladder Retractors	369
<b>MINI-FRIEDMANN</b> , Bone cutting forceps	466, 467
<b>MINI-GILLIES</b> , Needle holders scissors	247, 253
<b>MINI-HOHMANN</b> , Elevators	389
<b>MINI-LAMBOTTE</b> , Osteotomes	437, 438
<b>MINI-LEXER</b> , Osteotomes	440, 445
<b>MINI-OLSEN-HEGAR</b> , Needle holders scissors	246
<b>MINI-ROUX</b> , Retractor	291
<b>MINNESOTA</b> , Retractor	539
<b>MISKIMON</b> , Retractors	340
<b>MIXTER</b> , Hemostatic forceps	164
<b>MOLLISON</b> , Retractors	335
<b>MOLT</b> , Mouth gags for children	537
- Periostotomes	401
<b>MORRIS-DE BAKEY</b> , Vascular forceps	195
<b>MORSE</b> , Rib spreaders	367
<b>MÜNCHEN</b> , Biopsy curettes	646
<b>MUSEUX</b> , Uterine forceps	644

**N**

<b>NEGUS</b> , Hemostatic forceps and ligature	165
<b>NEGUS-GUEDEL</b> , Laryngoscopes	13, 16
<b>NELATON</b> , Probe	275





**NELSON**, Trocars 374  
**NELSON-METZENBAUM**, Operating scissors 62, 93  
**NEUBÜSER**, Tubal operation forceps 645  
**NEUMANN**, Angolate scissors 50  
**NICOLA**, Rhinology 555  
**NOVAK**, Suction curettes 646  
**NOYES**, Micro scissors 39, 601  
**NUBOER**, Suction tubes 666

**O**

**OBWEGESER**, Ligature needle 489  
 - Retractors 302, 303, 545  
 - Osteotomes 437, 449, 450, 568  
 - Periostotomes 398, 399, 400  
**OCHSNER**, Vascular forceps 205  
 - Trocars 374  
**OLDBERG**, Biopsy forceps 465  
**OLIVECRONA**, Dissectors 383  
 - Bone cutting forceps 469  
 - Spatulas malleable 326  
**OLLIER**, Retractors 297  
**OLSEN-HEGAR**, Needle holders with scissor 246, 253  
**OMBREDANNE**, Surgical mallets 431  
**ORINGER**, Mouth gags 538  
**OSHIKA-FAULKNER**, Eye instruments 596  
**OVERHOLT**, Ligature forceps 161  
**OVERHOLT-GEISSENDORFER**, Ligature forceps 161

**P**

**PAPAVERO-CASPAR**, Nasal specula 559  
**PAPAVERO-HARTMANN**, Nasal specula 559  
**PARAMETRIUM**, Operating scissors 97  
**PARKER-LANGENBECK**, Retractors 290  
**PARTSCH**, Osteotomes 435, 436  
**PATELLA**, Bone surgery 481  
**PAYR**, Intestinal forceps 174  
 - Conductor probes 269  
**PEAN**, Hemostatic forceps 150, 153, 156  
**PEAN-MURPHY**, Hemostatic forceps 140  
**PECK-JOSEPH**, Operating scissors 84  
**PEDERSON**, Vaginal specula 634  
**PELTON-CRANE**, Suction tubes 679  
**PENFIELD**, Dissectors 385  
**PERRY**, Tissue forceps 115  
**PERTHES**, Awis reamer 490  
**PHILIPS**, Screw driver 528  
**PIERCE**, Trocars 375  
**PIERSE**, Micro forceps 594  
**PLESTER**, Suction tubes 669  
 - Retractors 333, 334  
**POOLE**, Suction tubes 675  
**POTTS**, Vascular forceps 206, 208  
**POTTS-SMITH**, Vascular scissors 73  
 - Tissue forceps 120, 131  
**POTTS-YASARGIL**, Micro scissors 40  
**POZZI**, Uterine forceps 643  
**PRATT**, Uterine dilator 640  
**PRICE-THOMAS**, Vascular forceps 224  
**PROST**, Eye apecula 599  
**PUTTI**, Bone files 413

**Q**

**QUINBY**, Scissors 46  
**QUINKE**, Biopsy needle 378, 684

**R**

**RADOLF**, Nail nipper 488  
**RAGNEL-DAVIS**, Retractor 288  
**RAMPLEY**, Sponge and dressing forceps 142, 633  
**RAMUS**, Bone cutting forceps 548  
**RANDALL**, Suction tubes 646  
 - Kidney stone forceps 623

**RANKIN**, Hemostatic forceps 155  
**RECAMIER**, Uterine curettes 653  
**REDON**, Guide needles 270  
**REILL**, Micro Needle holders 610  
 - Bone surgery 480  
**REVERDIN**, Spatulas 326  
**REYNOLDS**, Operating scissors 51  
**RICARD**, Retractors 349  
**RICHARDSON**, Retractors 309  
**RICHARDSON-EASTMAN**, Retractors 309  
**ROBB**, Elevator 384  
**ROBIN**, Towel clamps 147  
**ROCHARD**, Retractors 363  
**ROCHESTER-CARMALT**, Hemostatic forceps 171  
**ROCHESTER-PEAN**, Hemostatic forceps 154, 162  
**RODHOIL**, Soluble lubricant for surgical instruments 687  
**ROGGE**, Sterilizing forceps 696  
**ROSEN**, Needles-Suction tubes 681  
**ROSER-KÖNIG**, Mouth gags 6, 537  
**ROSS**, Retractors 319  
**ROTAN**, Suction tubes 671  
**RÖTTGEN-RUSKIN**, Bone cutting forceps 471  
**ROUX**, Retractors 291  
**ROUX-MAGNUS**, Retractors 291  
**ROWE**, Bone surgery 550  
**RUBIN**, Nasal forceps 563  
**RUMEL**, Hemostatic forceps 163  
**RUSKIN-STILLE**, Bone cutting forceps 470  
**RUSKIN-LISTON**, Bone cutting forceps 474  
**RUSSIAN**, Tissue forceps 125  
**RYDER**, Needle holders 258  
**RYDEL-SEIFER**, Tuning fork 5

**S**

**SACHS**, Elevators 382  
**SALZBURG**, Elevators 396  
**SANDERS-BROWN**, Ligature needle 489  
**SANTULLI**, Bulldog clamps 180  
**SAROT**, Needle holders 254  
**SATINSKY**, Scissors 69  
 - Vascular forceps 225  
**SAUERBRUCH**, Costotomes 477  
 - Retractors 301, 315  
 - Bone cutting forceps 472  
 - Sterilizing forceps 697  
**SAUERBRUCH-FREY**, Costotomes 477  
**SAUG-RASPATORIUM**, Suction tubes 667  
**SCHAEDEL**, Towel clamps 146  
**SCHEDÉ**, Sharp curettes 419  
**SCHLESINGER**, Cervical laminectomy 456  
**SCHMID**, Vascular needles malleable 228, 681  
**SCHMIEDEN**, Ligature needles 267  
**SCHMIEDEN-DICK**, Ligature needles 267  
**SCHMIEDEN-TAYLOR**, Operating scissors 70  
**SCHNEIDER**, Raspatories 402  
**SCHRÖDER**, Sharp curettes 424  
 - Uterine forceps 643  
**SCHUBERT**, Biopsy forceps 649  
**SCHUMACHER**, Elevator 392  
 - Costotomes 477  
 - Biopsy forceps 650  
**SCOVILLE**, Retractor 292, 350, 351  
**SCOVILLE-HAVERFIELD**, Retractor 350  
**SEDILLOT**, Periostotomes 397  
 - Raspatories 402  
**SELDIN**, Elevator 395  
**SELMAN**, Hemostatic forceps 125  
**SEMB**, Raspatories 403  
**SEMKEN**, Tissue forceps 115, 120, 130  
**SENN-GREEN**, Retractors 287  
**SENN-MILLER**, Retractors 288  
**SEPTUN-NADEL**, Needles-Suction tubes 680  
**SHAPLEIGH**, Otology curettes 551  
**SIEBENMANN**, Suction tubes 677  
**SIEBOLD**, Operating scissors 78  
**SIGMOID-NOTCH**, Periostotomes-Retractors 388, 547  
**SILVER**, Rhinology 566  
**SIMON**, Sharp curettes 424



- Retractors	314
<b>SIMPSON</b> , Uterine sounds	642
<b>SIMPSON-BRAUN</b> , Uterine forceps	656
<b>SIMS</b> , Operating scissors	75, 76, 98
- Uterine sounds	642
<b>SINGLEY-TUTTLE</b> , Dressing forceps	125
<b>SMITH</b> , Wire and plate cutting scissors	102
<b>SMITH-BUIE</b> , Retractors	370
<b>SMITH-PETERSEN</b> , Osteotomes	442
<b>SNELLEN</b> , Eye instruments	591
<b>SPENCER</b> , Ligature scissors	100
<b>SPLIT</b> , Osteotomes	578
<b>SPURLING</b> , Biopsy forceps	461
<b>STACKE</b> , Probes	276
<b>STAMMBERGER</b> , Rhinology forceps	556
<b>STEINHÄUSER</b> , Periostotomes	400
<b>STEINMANN</b> , Wires extension	496, 497
<b>STELLBRINK</b> , Bone rongeurs	466
<b>STERNBERG</b> , Retractors	290, 539
<b>STEVENS</b> , Delicate scissors	51
- Needle holders	242
<b>STIEGLITZ</b> , Splinter forceps	134
<b>STILLE</b> , Operating scissors	67
- Osteotomes	441
- Bone rongeurs	471
- Tissue forceps	118
- Plaster cast breakers	533
- Kidney pedicle clamps forceps	175
- Needle holders	249
- Uterine forceps	629
- Gouges	441
<b>STILLE-BARRAYA</b> , Tissue forceps	124
<b>STRULLY</b> , Operating scissors	69
<b>STRUYCKEN</b> , Rhinology forceps	556
<b>SUBRAMANIAN</b> , Vascular forceps	221
<b>SUBRAMANIAN-MINIATURE</b> , Vascular forceps	221
<b>SWEDESH mod.</b> , Needle holder	254
<b>SYPERT</b> , Osteotomes	433
- Biopsy forceps	464

**T**

<b>TAKAHASHI</b> , Biopsy forceps	460
<b>TAYLOR</b> , Retractors	351
- Elevators	394
- Percussion hammers	3
- Tissue forceps	131
<b>TERRIER</b> , Hemostatic forceps	139
<b>TESSIER</b> , Sharp curettes	425, 583
- Retractors	313, 545
- Osteotomes	443, 583
- Bone cutting forceps	585
- Bone holding forceps	549
<b>THOMS-GAYLOR</b> , Biopsy forceps	647
<b>TISCHLER-MORGAN</b> , Biopsy forceps	650
<b>TOBOLD</b> , Tongue forceps	544
<b>TÖNNIS</b> , Operating scissors	63
- Needle holders	247, 259
<b>TÖNNIS-ADSON</b> , Operating scissors	63, 97
<b>TÖNNIS-RYDER</b> , Needle holders	259
<b>TROELTSCH</b> , Operating scissors	133
<b>TROEMNER</b> , Percussion hammers	3
<b>TROUTMAN</b> , Micro Eye forceps	596
- Micro Eye scissors	603
<b>TUBBS</b> , Retractors	229
<b>TUFFIER</b> , Rib spreader	367
- Spatulas malleable	326
<b>TUOHY</b> , Biopsy needle	378, 684

**U**

<b>UFFENORDE</b> , Sharp curettes	418
<b>ULRICH</b> , Bone cutting forceps	484
<b>UNIVERSAL</b> , Cotton applicators	277
- Trocars	376
<b>URO-TANGENTIAL</b> , Vascular forceps	220

**V**

<b>VALLEIX</b> , Uterine sounds	642
<b>VAN DOREN</b> , Biopsy forceps	648
<b>VANNAS</b> , Micro scissors	39, 43, 600
<b>VARADAY</b> , Vein instruments	228
<b>VERBRUGGE</b> , Bone surgery	482
<b>VERRES</b> , Biopsy needle	684
<b>WISE</b> , Micro forceps	107
<b>VOLKMANN</b> , Sharp curettes	417, 420
- Retractors	294, 295
<b>VOLLMAR</b> , Stripper	228

**W**

<b>WAGNER</b> , Bone surgery	500
- Biopsy forceps	464
<b>WALDMANN</b> , Episiotomy scissors	79
<b>WALLICH</b> , Uterine curettes	652
<b>WALTON</b> , Retractors	336
<b>WALTON-POOLE</b> , Suction tube	675
<b>WANGENSTEIN</b> , Tissue forceps	131
- needle holders	245, 252
<b>WASSMUND</b> , Retractors	299
<b>WEBER</b> , Eye instrumente	591
- Vascular forceps	204
<b>WEBSTER</b> , Needle holders	250
<b>WECKER</b> , Micro spatula	590
- Micro scissors	600
<b>WEIL-BLAKESLEY</b> , Biopsy forceps	459
<b>WEITLANER</b> , Retractors	330, 331, 332, 338
<b>WELLER</b> , Operating scissors	78
<b>WERTHEIM</b> , Operating scissors	58, 98
- Kidney pedicle clamps forceps	176, 630, 631
- Needle holders	256
<b>WEST</b> , Elevator	395
<b>WESTCOTT</b> , Micro scissors	39, 601
<b>WHERTEIMER</b> , Suction tube	674
<b>WHITEHEAD-JENNINGS</b> , Mouth gags	6, 540
<b>WIEDER</b> , Tongue forceps	544
<b>WIKSTROEM</b> , Ligature forceps	164
<b>WILDE</b> , Ear polypus snares	562
<b>WILDER</b> , Lacrymal dilators	592
<b>WILLIAMS</b> , Eye specula	599
<b>WILLIGER</b> , Sharp curettes	416, 422
- Elevators	381
- Surgical mallets	429
<b>WINTER</b> , Placenta and ovum forceps	632
<b>WOLFF</b> , Plaster cast breakers	532
<b>WULLSTEIN</b> , Suction tube	665, 681
- Retractors	330
- Ear instruments	554

**Y**

<b>YANKAUER</b> , Suction tube	662
<b>YASARGIL</b> , Suction tube	668
- Micro scissors	40, 43
- Biopsy scissors	465
- Micro forceps	110
- Needle holders	236, 237
<b>YASARGIL-NICOLA</b> , Rhinology Micro forceps	555
<b>YOUNG</b> , Tongue forceps	8, 143

**Z**

<b>ZAUFAL-JANSEN</b> , Bone surgery	470
<b>ZIEGLER</b> , Micro knife	27, 589
<b>ZIELINSKY</b> , Measuring instruments	22
<b>ZIELKE</b> , Osteotomes	448

**A**

<b>ADLERKREUTZ</b> , Chirurgische Pinzetten	124
<b>ADSON</b> , Absaugkanülen	674
- Wundspreizer	338, 339, 341, 343
- Raspatorien	401
- Anatomische Pinzetten	116, 130
<b>ADSON-BROWN</b> , Chirurgische Pinzetten	116
<b>ALAN-PARKS</b> , Wundspreizer	370
<b>ALDERDYCE</b> , Elevatorien	395
<b>ALEXANDER</b> , Knochensplitterzangen	468
- Probeexzisionzangen	649
<b>ALLIS</b> , Gewebe Fasszangen	145, 223
<b>ALLISON</b> , Wundspreizer	318
<b>ALM</b> , Wundspreizer	327
<b>ANDERSON-ADSON</b> , Wundspreizer	335
<b>ANDREWS-PYNCHON</b> , Absaugkanülen	662
<b>ANEL</b> , Augeninstrumente	593
<b>ANGLE</b> , Drahtschneidezangen	510
<b>ARKANSAS</b> , Schleifesteine	688
<b>ARRUGA</b> , Nadelhalter	261
- Augeninstrumente	592
<b>ASH</b> , Rhinologie	563
<b>AUFRIECHT</b> , Rhinologie	565
- Knochenfeilen	409
<b>AUSTIN</b> , Chirurgische Pinzetten	115

**B**

<b>BABBUSH</b> , Elevatorien	395
<b>BABCOCK</b> , Darmklemmen	144, 223
- Krampfader sonden, Biegsam	680
<b>BABINSKY</b> , Percussion Hämmer	3
<b>BABY-ADSON</b> , Arterienklemmen und Ligaturklemmen	160
<b>BABY-ALLIS</b> , Gewebe Fasszangen	145
<b>BABY-CRILE</b> , Arterienklemmen	152
<b>BABY-CRILE-WOOD</b> , Nadelhalter	250
<b>BABY-COLLIN</b> , Wundspreizer	346
<b>BABY-FINOCCHIETTO</b> , Wundspreizer	365
<b>BABY-METZENBAUM</b> , Feine Scheren	59
<b>BABY-MIXTER</b> , Arterienklemmen	160
<b>BABY-MORSE</b> , Ribbensperrerr	367
<b>BABY-WEITLANER</b> , Wundspreizer	330
<b>BABY-YANKAUER</b> , Absaugkanülen	662
<b>BACKHAUS</b> , Tuchklemmen	146
<b>BAILEY</b> , Ribbensperrerr	368
<b>BAINBRIDGE</b> , Darmklemmen	166
<b>BAKES</b> , Gallengang dilatatorien	625
<b>BALFOUR</b> , Bauchdeckenhalter	358, 359, 360
<b>BALFOUR-BABY</b> , Bauchdeckenhalter	358
<b>BALLENGER</b> , Rhinologie	569
- Scalpell	565
<b>BARON</b> , Absaugkanülen	670
<b>BARR</b> , Analspreizer	370
<b>BARRAQUER</b> , Sperrelevatorien	598
- Micro Pinzetten	595
- Micro Nadelhalter	609, 610, 611
- Pinzetten	135
- Nadelhalter	234
<b>BARTH</b> , Sharfe Löffel	416
<b>BAUMGARTNER</b> , Ligature Nadelhalter	511
<b>BEACHAM</b> , Amniotom für die Amnionblase	643
<b>BECK</b> , Atraumatische Gefäßklemmen	207
<b>BECKMANN</b> , Adenoidectomy	576
- Wundspreizer	342
<b>BECKMANN-EATON</b> , Wundspreizer	343
<b>BEEBE</b> , Draht und Blechsceren	103
<b>BEER</b> , Cilienpinzetten	135
<b>BELLUCCI</b> , Absaugkanülen	670
- Micro Scheren	554
<b>BENGOLEA</b> , Arterienklemmen	159
<b>BENIQUE</b> , Katheterspanner	624
<b>BENNET</b> , Elevatorien	393
<b>BERGH</b> , Cilienpinzetten	135
<b>BERGMANN</b> , Chirurgische Hämmer	430
<b>BERNHARD</b> , Tuchklemmen	148
<b>BEYER</b> , Hohlmeißelzangen	470
<b>BILLEAU</b> , Ohrschlingen	551

<b>BIRKETT</b> , Arterienklemmen	158
<b>BLAKE</b> , Uterusküretten	652
<b>BLOHMKE</b> , Darmklemmen	174
<b>BLOUNT</b> , Elevatorien	389, 393
<b>BLUMENTHAL</b> , Hohlmeißelzangen	467
<b>BÖHLER</b> , Hohlmeißelzangen	474
<b>BONNEY</b> , Chirurgische Pinzetten	131
<b>BOWLED-HENRY</b> , Wundspreizer	311
<b>BOWMAN</b> , Sonden	276
<b>BOYNTON</b> , Nadelhalter	249, 261
<b>BRAUN</b> , Chirurgische Scheren	
- Nierenstielklemmen	629
<b>BRAUN-STADLER</b> , Chirurgische Scheren	77
<b>BREISKY</b> , Scheidenspekula	638
<b>BROCK</b> , Scheren	41
- Pinzetten	109
- Nadelhalter	233
<b>BROWN</b> , Chirurgische Pinzetten	125
<b>BRUENINGS</b> , Zungenspatel	4
<b>BRUNNER</b> , Drahtumführungsnadel	268, 505
- Costotome	477
<b>BRUNS</b> , Sharfe Löffel	419
- Verband Scheren	101
<b>BUCHWALD</b> , Zungenspatel	4
<b>BÜCHS</b> , Wundspreizer	311
<b>BUCK</b> , Percussion Hämmer	3
<b>BUCK-GRAMCKO</b> , Elevatorien	389
<b>BUCKLEY</b> , Osteotome	434
<b>BUELAU</b> , Trokare	377
<b>BUMM</b> , Uterusküretten	654, 655
<b>BUNT</b> , Sterilisierzangen	697
<b>BUSHE</b> , Sharfe Löffel	423

**C**

<b>CAPLAN</b> , Rhinologie	564
<b>CASPAR</b> , Sharfe Löffel	425
- Wundspreizer	304, 352, 353
- Wundspreizer	354, 355
- Meßinstrumente	22
- Osteotome	433
- Probeexzisionzangen	462, 463
<b>CASTANEDA</b> , Atraumatische Gefäßklemmen	182
<b>CASTROVIEJO</b> , Sperrelevatorien	599
- Micro Wundspreizer	591
- Micro Scheren	603
- Micro Pinzetten	596
- Micro Spatel	592
- Nadelhalter	238, 239, 240, 241, 242
- Meßinstrumente	19, 20, 21
<b>CHADWICK</b> , Feine Scheren	46
<b>CHARNELY</b> , Wundspreizer	364
<b>CHEATTLE</b> , Sterilisierzangen	697
<b>CHILD</b> , Schwammzangen	8, 143
<b>CINELLI</b> , Rhinologie	567
<b>CITELLI</b> , Hohlmeißelzangen	453
<b>CLEANLACT</b> , Wasserlösliche von Chirurgische Instrumente	687
<b>CLOWARD</b> , Wundspreizer	345
- Wirbelkörperspreizer	356
<b>CLOWARD-CONTOUR</b> , Wundspreizer	329
<b>COAKLEY</b> , Sharfe Küretten	575
<b>COBB</b> , Raspatorien	407
<b>COLIBRI</b> , Micro Pinzetten	594
<b>COLLIN</b> , Costotome	475
- Wundspreizer	346, 347, 348
- Arterienklemmen	139, 143, 633
- Zungenzangen	7
- Klammernanlegepinzetten	271
- Sterilisierzangen	697
- Amputations	414
<b>COLLIN-Standard</b> , Scheidenspekula	634
<b>CONVERSE</b> , Wundhaken	288
- Nadelhalter	250
- Tenotome	28
<b>COOLEY</b> , Dilatator für Mitralstenosen	229
- Ribbensperrerr	324, 366
- Atraumatische Gefäßklemmen	212, 213, 214, 215, 216
<b>COOPER</b> , Ligature Nadel	267
<b>COOK</b> , Sperrelevatorien	599



<b>CORYLLOS</b> , Wundhaken	315
<b>COTTLE</b> , Wundhaken	284
- Elevatorien	396
- Feine Scheren	71
- Knochenfeilen	409
- Chirurgische Hämmer	430
- Osteotome	438, 579
- Anatomische Pinzetten	129
- Raspatorien-Elevatorien	565
- Nasal Spekula	559
- Knorpelquetsche	564
<b>COTTLE-MASING</b> , Feine Scheren	46
<b>COTTLE-NEIVERT</b> , Wundhaken	565
<b>COTTLE-WALSHAM</b> , Rhinologie	563
<b>COUPLAND</b> , Absaugkanülen	664, 665
<b>CRAFOORD</b> , Ligature Pinzetten	163
<b>CRILE</b> , Arterienklemmen	151, 152
<b>CRILE-WOOD</b> , Nadelhalter	243, 250, 252
<b>CRILE-MURRAY</b> , Nadelhalter	243
<b>CUSCO</b> , Scheidenspekula	634
<b>CUSHING</b> , Wundhaken	288, 289, 292
- Periostotome	401
- Probeexzisionzangen	461
- Hohlmeißelzangen	469
- Pinzetten	121, 131
- Biegsame Spatel	326
<b>CUSHING-KOCHER</b> , Wundhaken	292

**D**

<b>DALE</b> , Atraumatische Gefäßklemmen	217
<b>DANDY</b> , Feine Scheren	70
- Chirurgische Pinzetten	151
- Arterienklemmen	151
<b>DAUBENSPECK</b> , Sharfe Löffel	423
<b>DAUTREY-MUNRO</b> , Osteotome	581
<b>DAVIDSON</b> , Wundhaken	316
<b>DAVIS</b> , Elevatorien	382
- Sterilisierzangen	696
<b>DAVIS-BOYLE</b> , Mundsperrer	541
<b>DAY</b> , Instrumente für otologie	551
<b>DE BAKEY</b> , Absaugkanülen	664
- Gefäßdilatoren	226
- Scheren	73
- Nadelhalter	255
<b>DE BAKEY-BAHNSON</b> , Atraumatische Gefäßklemmen	193
<b>DE BAKEY-BAINBRIDGE</b> , Atraumatische Gefäßklemmen	187
<b>DE BAKEY-CAROTIS</b> , Atraumatische Gefäßklemmen	180
<b>DE BAKEY-MOSQUITO</b> , Atraumatische Gefäßklemmen	185
<b>DE BAKEY-HARKEN</b> , Atraumatische Gefäßklemmen	200
<b>DE BAKEY-PEAN</b> , Atraumatische Gefäßklemmen	186
<b>DE BAKEY (POTTS-SMITH)</b> , Scheren	73
- Pinzetten	126, 127, 128, 132
- Atraumatische Gefäßklemmen	183, 203
<b>DE BAKEY-RANKIN</b> , Atraumatische Gefäßklemmen	185
<b>DE BAKEY-SATINSKY</b> , Atraumatische Gefäßklemmen	180, 198
<b>DEAN</b> , Gezahnt Scheren	70
<b>DEAVER</b> , Chirurgische Scheren	57
- Wundhaken	320, 321
<b>DEJERINE</b> , Percussion Hämmer	3
<b>DEMEL</b> , Drahtumführungsnadel	504
<b>DENIS-BROWN</b> , Wundhaken	362
<b>DERF</b> , Nadelhalter	243, 250
<b>DERRA</b> , Atraumatische Gefäßklemmen	189
<b>DESCHAMPS</b> , Ligature Nadel	262, 263, 264, 265, 266
<b>DESJARDINS</b> , Nierensteinzangen	623
- Gallengangdilatoren	628
<b>DESMARRES</b> , Skalpelle	28
- Wundhaken	287
- Pinzetten	129
<b>DIETER</b> , Micro Hohlmeißelscheren	554
<b>DIETRICH</b> , Scheren	74
- Atraumatische Gefäßklemmen	205
- Micro Nadelhalter	240
<b>DIFFENBACH</b> , Bulldogklemmen	177
<b>DIXON-LOVELACE</b> , Arterienklemmen	158
<b>DINGMANN</b> , Mundsperrer	542
- Hohlmeißelzangen	485
<b>DITTEL</b> , Gallengangdilatoren	626

<b>DOCKHORN</b> , Wundspreizer	305
<b>DOLWICK-REICH</b> , Wundspreizer	337
<b>DOYEN</b> , Tuchklemmen	146
- Wundhaken	308, 363
- Atraumatische Gefäßklemmen	171
- Raspatorien	404
- Sonden	275
- Myom Instrumente	645
- Scheidenspekula	637
<b>DOYEN-COLLIN</b> , Mundsperrer	6, 537
<b>DOYEN-JANSEN</b> , Mundsperrer	6, 537
<b>DOYEN-STILLE</b> , Wundhaken	308
<b>DUBOIS</b> , Chirurgische Scheren	77
<b>DUKE</b> , Trokare	377
<b>DUNN-DAUTREY</b> , Wundhaken	546
<b>DUPLAY</b> , Spekula	18
<b>DUPUY-WEISSE</b> , Ligature Nadel	262
<b>DURANTE</b> , Pinzetten	125
<b>DUVAL</b> , Chirurgischen Pinzetten	129
- Atraumatische Gefäßklemmen	223
- Arterienklemmen	145, 629
<b>DUVAL-COLLIN</b> , Darmklemmen	629

**E**

<b>ECHLIN</b> , Hohlmeißelzangen	470
<b>EDER</b> , Watterträger	279
<b>EISELBERG-MATHIEU</b> , Nadelhalter	249
<b>ELLIS</b> , Micro Scalpelle	589
<b>EPKER</b> , Osteotome	578
<b>ESMARCH</b> , Verband Scheren	101

**F**

<b>FAGER</b> , Elevatorien	382
<b>FAHLBUSCH</b> , Micro Scheren für Rhinologie	555
<b>FARABEUF</b> , Wundspreizer	290
- Hohlmeißelzangen	478
- Raspatorien	402
<b>FARABEUF-LAMBOTTE</b> , Hohlmeißelzangen	478
<b>FARREL</b> , Watterträger	277
<b>FAULKNER</b> , Micro Pinzetten	596
<b>FAURE</b> , Tuchklemmen	146
- Probeexzisionzangen	648
<b>FEICHENFELD</b> , Chirurgische Pinzetten	134
<b>FEIN</b> , Watterträger	278
<b>FENO</b> , Scheidenspekula	656
<b>FERGUSSON</b> , Absaugkanülen	669
- Druckklemmen	166
<b>FERRIS-SMITH-KERRISON</b> , Laminektomie	454, 455, 456, 457
<b>FERRIS-SMITH-CUSHING</b> , Laminektomie	458
<b>FIBULA</b> , Hohlmeißelzangen	479
<b>FINOCCHIETTO</b> , Wundhaken	365
- Nadelhalter	257
<b>FINSEN</b> , Wundhaken	327
<b>FINSTERER</b> , Absaugkanülen	664
<b>FOERSTER-BALLENGER</b> , Tamponzangen	141
<b>FOMON</b> , Wundhaken	284
- Chirurgische Scheren	59, 70, 71
- Knochenfeilen	410, 412, 572
- Rhinologie	567
<b>FRANKFELDT</b> , Watterträger	279
<b>FRAZIER</b> , Absaugkanülen	669, 674, 680
- Wundhaken	350
<b>FREER</b> , Elevatorien	395
- Hohlmeißel	434
- Mucosameißer	572
<b>FRENZEL</b> , Zungenspatel	4
<b>FRIEDMANN</b> , Hohlmeißelzangen	467

**G**

<b>GABON</b> , Knochenmühle	586
<b>GALLAHER</b> , Knochenfeilen	408
<b>GARRETT</b> , Gefäßdilatoren	227
<b>GELLHORN</b> , Probeexzisionzangen	647
<b>GELPI</b> , Wundhaken	328



<b>GELPI-LOKTITE</b> , Wundhaken	329
<b>GELPI-SEILETZ</b> , Wundhaken	329
<b>GEMINI</b> , Arterienklemmen und Ligaturklemmen	162
<b>GENTOFT</b> , Scheiden Spekula	656
<b>GERALD</b> , Chirurgische Pinzetten	123
<b>GERALD-BROWN</b> , Chirurgische Pinzetten	123
<b>GERSTER</b> , Knochenchirurgie	487
<b>GERSTER-LOWMAN</b> , Knochenchirurgie	487
<b>GIDEF</b> , Arterienklemmen	150
<b>GIERTZ-STILLE</b> , Costotome	477
<b>GIGLI</b> , Amputations	414
<b>GIL-VERNET</b> , Wundhaken	293
<b>GILLIES</b> , Wundhaken	283
- Nadelhalter	247, 253
<b>GLASSMAN</b> , Chirurgische Scheren	52
<b>GLOVER</b> , Bulldogklemmen	179, 180
- Atraumatische Gefäßklemmen	207
<b>GOLDMAN-FOX</b> , Chirurgische Scheren	49, 50, 80, 84
<b>GOELET</b> , Wundhaken	291
<b>GORNEY</b> , Chirurgische Scheren	68
- Absaugkanülen	667
<b>GOSSET</b> , Bauchdeckenhalter	357
<b>GOURDET</b> , Uterusküretten	651
<b>GRAEFE</b> , Feine Scheren	46
- Micro Pinzetten	114, 129
- Micro Wundhaken	589, 590
- Micro Skalpelle	27, 590
<b>GRAY</b> , Ligaturklemmen	164
<b>GRAVE</b> , Scheiden Spekula	634
<b>GREGORY</b> , Atraumatische Gefäßklemmen	207
<b>GREENE</b> , Wundhaken	311
<b>GROSS</b> , Arterienklemmen	139, 141
<b>GRUENWALD</b> , Chirurgische Pinzetten	133
<b>GUILLIEN</b> , Absaugkanülen	667
<b>GUSBERG</b> , Endocervix-Biopsieküretten	646
<b>GUTHRIE</b> , Wundhaken	283
<b>GUYON</b> , Gallengangdilatoren	628
- Katheterspanner	624
- Nierenklemmen	175
- Uterusklemmen	629

**H**

<b>HABERER</b> , Biegsame Spatel	326
<b>HAGLUND</b> , Gipsschere	533
<b>HALLE</b> , Sharfe Löffel	422
<b>HALSEY</b> , Nadelhalter	243, 250
<b>HALSTED</b> , Arterienklemmen	150, 152
<b>HALSTED-MOSQUITO</b> , Arterienklemmen	149, 152
<b>HANK</b> , Uterusdilatoren	641
<b>HARRINGTON</b> , Wundhaken	317
<b>HARTMANN</b> , Zungendrucker	544
- Absaugkanülen	676, 677
- Stimmgabeln	5
- Watterträger	278
- Hohlmeißelzangen	469
- Ohr-Polypenzangen	552, 553
- Nasen Spekula	18, 560, 561
<b>HARTMANN-BABY-MOSQUITO</b> , Arterienklemmen	149
<b>HAYES</b> , Atraumatische Pinzetten	218
<b>HEANEY</b> , Nadelhalter	257
<b>HEANEY-HEGAR</b> , Nadelhalter	244
<b>HEAT</b> , Chirurgische Hämmer	431
<b>HEGAR</b> , Uterus Dilatoren	639, 641
- Nadelhalter	244, 251
<b>HEGAR-MAYO-SEELEY</b> , Nadelhalter	245, 252
<b>HEGENBARTH</b> , Chirurgische Pinzetten	271
<b>HEILDELBERG</b> , Watterträger	278
<b>HEISS</b> , Arterienklemmen	158
<b>HEISTER</b> , Mundsperrer	6, 537
<b>HEMINGWAY</b> , Sharfe Löffel	415
<b>HENAHAN</b> , Periostotome	401
<b>HENLEY</b> , Wundhaken	344
<b>HENNIG</b> , Gipsschere	533
<b>HEPARIN</b> , Biegsam Absaugkanülen	682
<b>HEYMANN</b> , Chirurgische Scheren	71
<b>HEYMANN-KNIGHT</b> , Chirurgische Scheren	71
<b>HIBBS</b> , Wundhaken	297
- Osteotome	439

<b>HOHMANN</b> , Elevatorien	391, 394
<b>HOLZBACH</b> , Wundhaken	349
<b>HÖPFNER</b> , Darmklemmen	174
<b>HOPT</b> , Atraumatische Gefäßklemmen	219
<b>HOUSE</b> , Absaugkanülen	672
<b>HOWARD</b> , Knochenfeilen	408, 570
<b>HOWARTH</b> , Periostotome	397
<b>HUNTER</b> , Splitterpinzetten	134
<b>HURD</b> , Periostotome	397

**I**

<b>INGE</b> , Wirbelkörperspreizer	356
<b>IRIS</b> , Feine Scheren	44, 81, 83, 84, 99
<b>ISRAEL</b> , Wundhaken	298
<b>ITARD</b> , Absaugkanülen	677

**J**

<b>JACKSON-TESSIER</b> , Knochensplitterschere	476
<b>JACOBSON</b> , Sharfe Löffel	416
- Micro Scheren	40
- Handbohrfutter	501, 502, 503, 527
- Nadelhalter	235, 241
<b>JACOBSON-UNIVERSAL</b> , Handbohrfutter	527
<b>JAMESON</b> , Feine Scheren	47
<b>JAMESON-WERBER</b> , Feine Scheren	47
<b>JANSEN</b> , Sharfe Löffel	416
- Wundhaken	327
- Hohlmeißelzangen	469
- Pinzetten	133
- Raspatorien	402
<b>JANSEN-LEUER</b> , Hohlmeißelzangen	468
<b>JAVID</b> , Atraumatische Gefäßklemmen	222
<b>JONES</b> , Tuchklemmen	146
- Arterienklemmen	139
<b>JOSEPH</b> , Wundhaken	284
- Chirurgische Scheren	58
- Knochenfeilen	408
- Rhinologie	573, 574
- Periostotome	401
<b>JUDD-MASSON</b> , Blasenwundspreizer	369

**K**

<b>KALLMORGEN</b> , Scheidenspekula	635
<b>KELLY</b> , Wundhaken	310
- Chirurgische Scheren	53, 85
- Arterienklemmen	155
<b>KERN</b> , Hohlmeißelzangen	486
<b>KERPEL</b> , Sharfe Löffel	418
<b>KERSHNER</b> , Augeninstrumente	598
<b>KERRISON</b> , Laminectomie	453
<b>KERRISON-JACOBY</b> , Laminectomie	455
<b>KEVORKIAN</b> , Probeexzisionzangen	650
<b>KEY-HORSLEY</b> , Knochensplitterschere	475
<b>KEYES</b> , Hautstanzen	28, 491
<b>KILLIAN</b> , Absaugkanülen	678
- Nasen Scheren	72
- Rhinologie	564
- Hohlmeißel	565
- Nasen Spekula	560, 561
<b>KILLIAN-KLAUS</b> , Osteotome	565
<b>KILNER</b> , Scheren	47, 52, 85
- Nadelhalter	256
<b>KILNER-DOUGHTY</b> , Mundsperrer	540
<b>KIMURA</b> , Micro Spatula	592
<b>KIRSCH</b> , Wundhaken	304
<b>KIRSCHNER</b> , Wundhaken	361
<b>KLIMA-ROSEGGGER</b> , Punktionskanülen	377
<b>KOCHER</b> , Unterbindungsnadel	267
- Wundhaken	292, 294, 296, 301, 305, 307
- Arterienklemmen	153, 155, 157
- Darmklemmen	172, 173
- Sonden	269
<b>KOCHER-LAGENBECK</b> , Wundhaken	300
<b>KOCHER-OCHSNER</b> , Chirurgische Pinzetten	154



<b>KOENIG</b> , Sonden	269
<b>KOERTE</b> , Wundhaken	323
<b>KÖNIG</b> , Elevatorien	381
<b>KRAUSE</b> , Polypenschnürer	562
- Trokare	375
<b>KRESSNER</b> , Nasen Pinzetten	563
<b>KRISTELLER</b> , Scheidenspekula und halter	636
<b>KROENIG</b> , Zungenspatel	4
<b>KRONECKER</b> , Ligaturnadel	262
<b>KÜHNE</b> , Cilienpinzetten	135
<b>KÜNTSCHER</b> , Bohrdrähte	496
- Knochenchirurgie	500

**L**

<b>LA FORCE</b> , Micro Skalpelle	589
<b>LA GRANGE</b> , Chirurgische Scheren	50, 80
<b>LAHEY</b> , Wundhaken	288
<b>LAMBERT-KAY</b> , Atraumatische Gefäßklemmen	210
<b>LAMBOTTE</b> , Osteotome	437
- Hohlmeißelzangen	478
- Raspatorien	404
<b>LANDAU</b> , Scheidenspekula	637
<b>LANDOLT</b> , Skalpellgriffe	34
- Probeexzisionzangen	465
<b>LANE</b> , Schraubendreher	528
- Hohlmeißelzangen	486
<b>LANGE</b> , Wundhaken	289
<b>LANGENBECK</b> , Nadelhalter	259
- Wundhaken	299
- Elevatorien	395
- Raspatorien	402
- Amputations	414
<b>LANGENBECK-RYDER</b> , Nadelhalter	259
<b>LAWRENCE</b> , Arterienklemmen und Ligaturklemmen	165
<b>LEES</b> , Atraumatische Gefäßklemmen	209
<b>LEKSELL</b> , Hohlmeißelzangen	470
<b>LELAND-JONES</b> , Atraumatische Gefäßklemmen	215
<b>LEMPERT</b> , Hohlmeißelzangen	468
<b>LERICHE</b> , Arterienklemmen	151
<b>LEWIN</b> , Knochenhaltanzangen	479
<b>LEWIS</b> , Knochenfeilen	409
- Rhinologie	573
<b>LEXER</b> , Chirurgische Scheren	66, 95
- Osteotome	446, 448
- Hohlmeißel	445, 446
<b>LEVIS</b> , Sthetoskop	10
<b>LICHTENBERG</b> , Nadelhalter	261
<b>LICHTWITZ</b> , Trokare	375
<b>LIEBERMANN-TENNANT</b> , Augeninstrumente	598
<b>LINDEMANN</b> , Amputations	414
<b>LISTER</b> , Verband Scheren	101
- Arterienklemmen	139
<b>LISTER-BURCH</b> , Sperreleatoren	599
<b>LISTON</b> , Hohlmeißelzangen	473
<b>LISTON-STILLE</b> , Hohlmeißelzangen	475
<b>LITTAUER</b> , Ohr Instrumente	552
- Cilienpinzetten	135
<b>LITTLER</b> , Feine Scheren	59
<b>LITTLEWOOD</b> , Uterus Pinzetten	644
<b>LOCHART</b> , Sonden	275
<b>LOCKLIN</b> , Feine Scheren	48, 53
<b>LÖFFEL</b> , Rhinologie	558
<b>LOGAN</b> , Wundhaken	327
<b>LORENZ</b> , Verband Scheren	101
<b>LORNA</b> , Tuchklemmen	147
<b>LOUTE</b> , Drahtspanninstrumente	499
<b>LOVE</b> , Wundhaken	289
<b>LOVE-GRUENWALD</b> , Probeexzisionzangen	460, 461
<b>LUCAE</b> , Stimmgabeln	5
- Chirurgische Hämmer	429
- Chirurgische Pinzetten	133
- Instrumente für otologie	551
<b>LUER</b> , Hohlmeißelzangen	
<b>LUER-KÖRTE</b> , Uterus Cüretten	651
<b>LUER-LOCK</b> , Abasaugkanülen	681
<b>LUER-STILLE</b> , Hohlmeißelzangen	469, 471, 472

**M**

<b>MAGILL</b> , Absaugkanülen	678
- Kathetereinführungszangen	7
<b>MAIER</b> , Tamponzangen	142, 633
<b>MALTZ</b> , Rhinologie	574
<b>MARKHAM-MEYERDING</b> , Wundhaken	336
<b>MARTIN</b> , Wundhaken	314
- Hohlmeißelzangen	485
- Watterträger	277
- Uterussonden	642
<b>MARTINI</b> , Sharfe Löffel	416
<b>MASING</b> , Elevatorien	396
<b>MASSON</b> , Nadelhalter	245, 257
<b>MATHIEU</b> , Wundhaken	290
- Blasewundspreizer	369
- Nadelhalter	248, 249, 260
- Scheidenspekula	635
<b>MAYO</b> , Chirurgische Scheren	64, 65, 82, 96
- Uterussonden Biagsam	642
- Spatel	4
- Sterilisierzangen	697
<b>MAYO-HARRINGTON</b> , Scheren	75
<b>MAYO-HEGAR</b> , Nadelhalter	244, 251, 252
<b>MAYO-HEGAR-HEANEY</b> , Nadelhalter	256
<b>MAYO-LEXER</b> , Chirurgische Scheren	96
<b>MAYO-NOBLE</b> , Chirurgische Scheren	64
<b>MAYO-RUSSIAN</b> , Pinzetten	125
<b>MAYO-STILLE</b> , Scheren	67, 94
<b>MC DONALD</b> , Elevatorien	397
<b>MC INTOSH</b> , Laringoskope	11, 14, 16
<b>MC IVOR</b> , Mundsperr	541
<b>MC KENTY</b> , Elevatorien	397
<b>MC KESSON</b> , Absaugkanülen	660
<b>MC PHERSON</b> , Micro Pinzetten	595, 596
<b>MEAD</b> , Elevatorien	395
- Chirurgische Hämmer	429
- Hohlmeißelzangen	467
<b>MEEKER</b> , Arterienklemmen und Ligaturklemmen	165
<b>MELLINGER</b> , Sperreleatoren	599
<b>METZENBAUM</b> , Scheren	59, 60, 61, 81, 84, 89, 90, 91, 92, 99
<b>MEYERDING</b> , Wundhaken	312, 335
<b>MICHEL</b> , Klammernanlegepinzetten	271
<b>MICRO-HALSTEAD</b> , Arterienklemmen	149
<b>MICRO-HARTMANN</b> , Ohr Instrumente	552
<b>MICRO-IRIS</b> , Feine Scheren	44
<b>MICRO-RYDER</b> , Nadelhalter	258
<b>MICRO-VASCULAR</b> , Nadelhalter	255
<b>MIDDLELDORPF</b> , Wundhaken	306
<b>MIKULICZ</b> , Wundhaken	322, 323
- Arterienklemmen	158
<b>MILLER</b> , Laringoskope	12, 15, 16
- Knochenfeilen	408, 570
<b>MILLIGAN</b> , Elevatorien	382
<b>MILLIN</b> , Blasenwundspreizer	369
<b>MINI-FRIEDMANN</b> , Hohlmeißelzangen	466, 467
<b>MINI-GILLIES</b> , Nadelhalter Scheren	247, 253
<b>MINI-HOHMANN</b> , Elevatorien	389
<b>MINI-LAMBOTTE</b> , Osteotome	437, 438
<b>MINI-LEXER</b> , Osteotome	440, 445
<b>MINI-OLSEN-HEGAR</b> , Nadelhalter Scheren	246
<b>MINI-ROUX</b> , Wundhaken	291
<b>MINNESOTA</b> , Wundhaken	539
<b>MISKIMON</b> , Wundhaken	340
<b>MIXTER</b> , Arterienklemmen	164
<b>MOLLISON</b> , Wundhaken	335
<b>MOLT</b> , Mundsperr für kinder	537
- Periostotome	401
<b>MORRIS-DE BAKEY</b> , Atraumatische Gefäßklemmen	195
<b>MORSE</b> , Rippensperr	367
<b>MÜNCHEN</b> , Uterus Biopsie Saugküretten	646
<b>MUSEUX</b> , Uterus Pinzetten	644

**N**

<b>NEGUS</b> , Arterienklemmen und Ligaturklemmen	165
<b>NEGUS-GUEDEL</b> , Laringoskope	13, 16
<b>NELATON</b> , Sonden	275

deutsch



<b>NELSON</b> , Trokare	374
<b>NELSON-METZENBAUM</b> , Chirurgische Pinzetten	62, 93
<b>NEUBÜSER</b> , Instrumente für Tubenoperationen	645
<b>NEUMANN</b> , Chirurgische Scheren	50
<b>NICOLA</b> , Micro Pinzetten für Rhinologie	555
<b>NOVAK</b> , Uterus Biopsie Saugküretten	646
<b>NOYES</b> , Micro Scheren	39, 601
<b>NUBOER</b> , Absaugkanülen	666

**O**

<b>OBWEGESER</b> , Ligaturnadel	489
- Wundhaken	302, 303, 545
- Osteotome	437, 449, 450, 568
- Periostotome	398, 399, 400
<b>OCHSNER</b> , Atraumatische Gefäßklemmen	205
- Trokare	374
<b>OLDBERG</b> , Laminectomyzangen	465
<b>OLIVECRONA</b> , Dissektoren	383
- Hohlmeißelzangen	469
- Biegsame Spatel	326
<b>OLLIER</b> , Wundhaken	297
<b>OLSEN-HEGAR</b> , Nadelhalter mit Scheren	246, 253
<b>OMBREDANNE</b> , Chirurgische Hämmer	431
<b>ORINGER</b> , Mundsperrer	538
<b>OSHIKA-FAULKNER</b> , Augeninstrumente	596
<b>OVERHOLT</b> , Ligaturklemmen	161
<b>OVERHOLT-GEISSENDORFER</b> , Ligaturklemmen	161

**P**

<b>PAPAVERO-CASPAR</b> , Nasen Spekula	559
<b>PAPAVERO-HARTMANN</b> , Nasen Spekula	559
<b>PARAMETRIUM</b> , Chirurgischen Scheren	97
<b>PARKER-LANGENBECK</b> , Wundhaken	290
<b>PARTSCH</b> , Osteotome	435, 436
<b>PATELLA</b> , Knochenchirurgie	481
<b>PAYR</b> , Darmklemmen	174
- Sonden	269
<b>PEAN</b> , Arterienklemmen	150, 153, 156
<b>PEAN-MURPHY</b> , Arterienklemmen	140
<b>PECK-JOSEPH</b> , Chirurgische Scheren	84
<b>PEDERSON</b> , Scheiden Spekula	634
<b>PELTON-CRANE</b> , Absaugkanülen	679
<b>PENFIELD</b> , Dissektoren	385
<b>PERRY</b> , Chirurgische Pinzetten	115
<b>PERTHES</b> , Bohrinstrumente pfrieme	490
<b>PHILIPS</b> , Schraubendreher	528
<b>PIERCE</b> , Trokare	375
<b>PIERSE</b> , Micro Pinzetten	594
<b>PLESTER</b> , Absaugkanülen	669
- Wundhaken	333, 334
<b>POOLE</b> , Absaugkanülen	675
<b>POTTS</b> , Atraumatische Gefäßklemmen	206, 208
<b>POTTS-SMITH</b> , Gefäßscheren	73
- Chirurgischen Pinzetten	120, 131
<b>POTTS-YASARGIL</b> , Micro Scheren	40
<b>POZZI</b> , Uterus Pinzetten	643
<b>PRATT</b> , Uterusdilatoren	640
<b>PRICE-THOMAS</b> , Atraumatische Gefäßklemmen	224
<b>PROST</b> , Perreleatoren	599
<b>PUTTI</b> , Knochenfeilen	413

**Q**

<b>QUINBY</b> , Scheren	46
<b>QUINKE</b> , Nadel für Biopsie	378, 684

**R**

<b>RADOLF</b> , Nagel aus Reißzange	488
<b>RAGNEL-DAVIS</b> , Wundhaken	288
<b>RAMPLEY</b> , Tamponzangen	142, 633
<b>RAMUS</b> , Hohlmeißelzangen	548
<b>RANDALL</b> , Absaugkanülen	646
- Nierensteinzangen	623

<b>RANKIN</b> , Arterienklemmen	155
<b>RECAMIER</b> , Uterusküretten	653
<b>REDON</b> , Führungsnadel	270
<b>REILL</b> , Micro Nadelhalter	610
- Knochenchirurgie	480
<b>REVERDIN</b> , Spatel	326
<b>REYNOLDS</b> , Chirurgische Scheren	51
<b>RICARD</b> , Wundhaken	349
<b>RICHARDSON</b> , Wundhaken	309
<b>RICHARDSON-EASTMAN</b> , Wundhaken	309
<b>ROBB</b> , Elevatoren	384
<b>ROBIN</b> , Tuchklemmen	147
<b>ROCHARD</b> , Wundhaken	363
<b>ROCHESTER-CARMALT</b> , Arterienklemmen	171
<b>ROCHESTER-PEAN</b> , Arterienklemmen	154, 162
<b>RODHOIL</b> , Schmeiermittel für Chirurgische Instrumente	687
<b>ROGGE</b> , Sterilisierzangen	696
<b>ROSEN</b> , Absaugkanülen	681
<b>ROSER-KÖNIG</b> , Mundsperrer	6, 537
<b>ROSS</b> , Wundhaken	319
<b>ROTAN</b> , Absaugkanülen	671
<b>RÖTTGEN-RUSKIN</b> , Hohlmeißelzangen	471
<b>ROUX</b> , Wundhaken	291
<b>ROUX-MAGNUS</b> , Wundhaken	291
<b>ROWE</b> , Knochen chirurgie	550
<b>RUBIN</b> , Nasenzangen	563
<b>RUMEL</b> , Arterienklemmen und Ligaturklemmen	163
<b>RUSKIN-STILLE</b> , Hohlmeißelzangen	470
<b>RUSKIN-LISTON</b> , Hohlmeißelzangen	474
<b>RUSSIAN</b> , Chirurgische Pinzetten	125
<b>RYDER</b> , Nadelhalter	258
<b>RYDEL-SEIFER</b> , Stimmgabeln	5

**S**

<b>SACHS</b> , Elevatoren	382
<b>SALZBURG</b> , Elevatoren	396
<b>SANDERS-BROWN</b> , Ligaturnadel	489
<b>SANTULLI</b> , Bulldogklemmen	180
<b>SAROT</b> , Nadelhalter	254
<b>SATINSKY</b> , Scheren	69
- Atraumatische Gefäßklemmen	225
<b>SAUERBRUCH</b> , Rippenscheren	477
- Wundhaken	301, 315
- Hohlmeißelzangen	472
- Sterilisierzangen	697
<b>SAUERBRUCH-FREY</b> , Rippenscheren	477
<b>SAUG-RASPATORIUM</b> , Absaugkanülen	667
<b>SCHAEDEL</b> , Tuchklemmen	146
<b>SCHUDE</b> , Sharfe Löffel	419
<b>SCHLESINGER</b> , Laminektomie	456
<b>SCHMID</b> , Gefäßspülkanülen Biegsam	228, 681
<b>SCHMIEDEN</b> , Ligaturnadel	267
<b>SCHMIEDEN-DICK</b> , Ligaturnadel	267
<b>SCHMIEDEN-TAYLOR</b> , Chirurgische Scheren	70
<b>SCHNEIDER</b> , Raspatorien	402
<b>SCHRÖDER</b> , Sharfe Löffel	424
- Uteruszangen	643
<b>SCHUBERT</b> , Probeexsizionzangen	649
<b>SCHUMACHER</b> , Elevatoren	392
- Rippenscheren	477
- Probeexsizionzangen	650
<b>SCOVILLE</b> , Wundhaken	292, 350, 351
<b>SCOVILLE-HAVERFIELD</b> , Wundhaken	350
<b>SEDILLOT</b> , Periostotome	397
- Raspatorien	402
<b>SELDIN</b> , Elevatoren	395
<b>SELMAN</b> , Anatomische Pinzetten	125
<b>SEMB</b> , Raspatorien	403
<b>SEMKEN</b> , Chirurgische Pinzetten	115, 120, 130
<b>SENN-GREEN</b> , Wundhaken	287
<b>SENN-MILLER</b> , Wundhaken	288
<b>SEPTUN-NADEL</b> , Absaugkanülen	680
<b>SHAPLEIGH</b> , Instrumente für otologie	551
<b>SIEBENMANN</b> , Absaugkanülen	677
<b>SIEBOLD</b> , Chirurgische Scheren	78
<b>SIGMOID-NOTCH</b> , Raspatorien-Wundhaken	388, 547
<b>SILVER</b> , Nasen Skalpelle	566
<b>SIMON</b> , Sharfe Löffel	424



- Wundhaken	314
<b>SIMPSON</b> , Uterussonden	642
<b>SIMPSON-BRAUN</b> , Geburtszange	656
<b>SIMS</b> , Chirurgische Scheren	75, 76, 98
- Uterussonden	642
<b>SINGLEY-TUTTLE</b> , Anatomische Pinzetten	125
<b>SMITH</b> , Dracht und Blechscheren	102
<b>SMITH-BUIE</b> , Wundhaken	370
<b>SMITH-PETERSEN</b> , Osteotome	442
<b>SNELLEN</b> , Augeninstrumente	591
<b>SPENCER</b> , Ligaturscheren	100
<b>SPLIT</b> , Rhinologie	578
<b>SPURLING</b> , Proobexsizionzangen	461
<b>STACKE</b> , Sonden	276
<b>STAMMBERGER</b> , Rhinologie	556
<b>STEINHÄUSER</b> , Raspatorien	400
<b>STEINMANN</b> , Bohrdrähte	496, 497
<b>STELLBRINK</b> , Knochenzangen	466
<b>STERNBERG</b> , Wundhaken	290, 539
<b>STEVENS</b> , Feine Scheren	51
- Nadelhalter	242
<b>STIEGLITZ</b> , Splitterpinzetten	134
<b>STILLE</b> , Chirurgische Pinzetten	67
- Osteotome	441
- Knochenzangen	471
- Chirurgische Pinzetten	118
- Gipsscheren	533
- Nierenklemmen	175
- nadelhalter	249
- Uteruszangen	629
- Hohlmeißel	441
<b>STILLE-BARRAYA</b> , Chirurgische Pinzetten	124
<b>STRULLY</b> , Chirurgische Scheren	69
<b>STRUYCKEN</b> , Rhinologie	556
<b>SUBRAMANIAN</b> , Atraumatische Gefäßklemmen	221
<b>SUBRAMANIAN-MINIATURE</b> , Atraumatische Gefäßklemmen	221
<b>SWEDESH mod.</b> , Nadelhalter	254
<b>SYPERT</b> , Osteotome	433
- Probeexsizionzange	464

**T**

<b>TAKAHASHI</b> , Probeexsizionzange	460
<b>TAYLOR</b> , Wundhaken	351
- Elevatoren	394
- Percussion Hämmer	3
- Chirurgische Pinzetten	131
<b>TERRIER</b> , Arterienklemmen	139
<b>TESSIER</b> , Sharfe Löffel	425
- Wundhaken	313, 545
- Osteotome	443, 583
- Knochenchirurgie	585
- Knochenchirurgie	549
<b>THOMS-GAYLOR</b> , Probeexsizionzange	647
<b>TISCHLER-MORGAN</b> , Probeexsizionzange	650
<b>TOBOLD</b> , Zungendrucker	544
<b>TÖNNIS</b> , Chirurgische Scheren	63
- Nadelhalter	247, 259
<b>TÖNNIS-ADSON</b> , Chirurgische Scheren	63, 97
<b>TÖNNIS-RYDER</b> , Nadelhalter	259
<b>TROELTSCH</b> , Anatomische Pinzetten	133
<b>TROEMNER</b> , Percussion Hämmer	3
<b>TROUTMAN</b> , Micro Pinzetten	596
- Micro Scheren	603
<b>TUBBS</b> , Dilatatoren	229
<b>TUFFIER</b> , Rippensperrer	367
- Biegsame Spatel	326
<b>TUOHY</b> , Biopsie kanülen	378, 684

**U**

<b>UFFENORDE</b> , Sharfe Löffel	418
<b>ULRICH</b> , Knochenhaltenzangen	484
<b>UNIVERSAL</b> , Watterträger	277
- Trokare	376
<b>URO-TANGENTIAL</b> , Atraumatische Gefäßklemmen	220

**V**

<b>VALLEIX</b> , Uterussonden	642
<b>VAN DOREN</b> , Probeexsizionzangen	648
<b>VANNAS</b> , Micro Scheren	39, 43, 600
<b>VARADAY</b> , Ringstripper	228
<b>VERBRUGGE</b> , Knochenhaltenzangen	482
<b>VERES</b> , Biopsie Kanülen	684
<b>WISE</b> , Micro Pinzetten	107
<b>VOLKMANN</b> , Swharfe Löffel	417, 420
- Wundhaken	294, 295
<b>VOLLMAR</b> , Stripper	228

**W**

<b>WAGNER</b> , Knochenchirurgie	500
- Probeexsizionzange	464
<b>WALDMANN</b> , Episiotomie-Scheren	79
<b>WALLICH</b> , Uterusküretten	652
<b>WALTON</b> , Wundhaken	336
<b>WALTON-POOLE</b> , Absaugkanülen	675
<b>WANGENSTEEN</b> , Chirurgische Pinzetten	131
- Nadelhalter	245, 252
<b>WASSMUND</b> , Wundhaken	299
<b>WEBER</b> , Augeninstrumente	591
- Atraumatische Gefäßklemmen	204
<b>WEBSTER</b> , Nadelhalter	250
<b>WECKER</b> , Micro Spatel	590
- Micro Scheren	600
<b>WEIL-BLAKESLEY</b> , Probeexsizionzange	459
<b>WEITLANER</b> , Wundhaken	330, 331, 332, 338
<b>WELLER</b> , Chirurgische Scheren	78
<b>WERTHEIM</b> , Chirurgische Scheren	58, 98
- Nierenklemmen	176, 630, 631
- Nadelhalter	256
<b>WEST</b> , Elevatoren	395
<b>WESTCOTT</b> , Micro Scheren	39, 601
<b>WHERTEIMER</b> , Absaugkanülen	674
<b>WHITEHEAD-JENNINGS</b> , Mundsperrer	6, 540
<b>WIEDER</b> , Zungendrucker	544
<b>WIKSTROEM</b> , Ligaturklemmen	164
<b>WILDE</b> , Polypenschnürer	562
<b>WILDER</b> , Tränenkanal Dilatatoren	592
<b>WILLIAMS</b> , Sperrelevatoren	599
<b>WILLIGER</b> , Sharfe Löffel	416, 422
- Elevatoren	381
- Chirurgische Hämmer	429
<b>WINTER</b> , Placentar und Abortuszangen	632
<b>WOLFF</b> , Gipszangen	532
<b>WULLSTEIN</b> , Absaugkanülen	665, 681
- Wundhaken	330
- Ohr Instrumente	554

**Y**

<b>YANKAUER</b> , Absaugkanülen	662
<b>YASARGIL</b> , Absaugkanülen	668
- Micro Scheren	40, 43
- Probeexsizionzangen	465
- Micro Pinzetten	110
- Nadelhalter	236, 237
<b>YASARGIL-NICOLA</b> , Micro Pinzetten für Rhinologie	555
<b>YOUNG</b> , Zungenzangen	8, 143

**Z**

<b>ZAUFAL-JANSEN</b> , Hohlmeißelzangen	470
<b>ZIEGLER</b> , Micro Skalpelle	27, 589
<b>ZIELINSKY</b> , Meißelinstrumente	22
<b>ZIELKE</b> , Osteotome	448



**A**

<b>ADLERKREUTZ</b> , Pincés chirurgiques	124
<b>ADSON</b> , Canules aspiratrices	674
- Ecarteurs	338, 339, 341, 343
- Rugines	401
- Pincés anatomiques	116, 130
<b>ADSON-BROWN</b> , Pincés chirurgiques	116
<b>ALAN-PARKS</b> , Ecarteurs	370
<b>ALDERDYCE</b> , Elevateurs	395
<b>ALEXANDER</b> , Pincés à os	468
- Pincés à biopsie	649
<b>ALLIS</b> , Pincés pour saisir les tissue	145, 223
<b>ALLISON</b> , Ecarteurs	318
<b>ALM</b> , Ecarteurs	327
<b>ANDERSON-ADSON</b> , Ecarteurs	335
<b>ANDREWS-PYNCHON</b> , Canules aspiratrices	662
<b>ANEL</b> , Instrumentes pour l'oftalmologie	593
<b>ANGLE</b> , Pincés à couper les fil	510
<b>ARKANSAS</b> , Pierres d'affutage	688
<b>ARRUGA</b> , Porte aiguilles	261
- Instrumentes pour l'oftalmologie	592
<b>ASH</b> , Rhinologie	563
<b>AUFRIEHT</b> , Rhinologie	565
- Limes à os	409
<b>AUSTIN</b> , Pincés chirurgiques	115

**B**

<b>BABBUSH</b> , Elevateurs	395
<b>BABCOCK</b> , Pincés intestinales	144, 223
- Sondes pour varices malléable	680
<b>BABINSKY</b> , Marteaux percuteurs	3
<b>BABY-ADSON</b> , Pincés hémostatiques et à ligatures	160
<b>BABY-ALLIS</b> , Pincés pour saisir les tissue	145
<b>BABY-CRILE</b> , Pincés hémostatiques	152
<b>BABY-CRILE-WOOD</b> , Porte aiguilles	250
<b>BABY-COLLIN</b> , Ecarteurs	346
<b>BABY-FINOCCHIETTO</b> , Ecarteurs	365
<b>BABY-METZENBAUM</b> , Ciseaux chirurgicaux	59
<b>BABY-MIXTER</b> , Pincés hémostatiques	160
<b>BABY-MORSE</b> , Ecarteurs des cotes	367
<b>BABY-WEITLANER</b> , Ecarteurs	330
<b>BABY-YANKAUER</b> , Canules aspiratrices	662
<b>BACKHAUS</b> , Pincés pour fixer les compresses	146
<b>BAILEY</b> , Ecarteurs des cotes	368
<b>BAINBRIDGE</b> , Pincés intestinales	166
<b>BAKES</b> , Dilateurs pour les voies biliaires	625
<b>BALFOUR</b> , Divaricatori addominali	358, 359, 360
<b>BALFOUR-BABY</b> , Ecarteurs abdominaux	358
<b>BALLENGER</b> , Rhinologie	569
- Gouges	565
<b>BARON</b> , Canules aspiratrices	670
<b>BARR</b> , Ecarteurs rectaux	370
<b>BARRAQUER</b> , Blépharostats	598
- Micro pincés	595
- Micro porte aiguilles	609, 610, 611
- Pincés	135
- Porte aiguilles	234
<b>BARTH</b> , Curettes tranchantes	416
<b>BAUMGARTNER</b> , Porte aiguilles à ligatures	511
<b>BEACHAM</b> , Amniotome pour la vésicule amniotique	643
<b>BECK</b> , Pincés vasculaires	207
<b>BECKMANN</b> , Adénoïdes	576
- Ecarteurs	342
<b>BECKMANN-EATON</b> , Ecarteurs	343
<b>BEEBE</b> , Ciseaux coupe-fils métalliques	103
<b>BEER</b> , Pincés à épiler les ciles	135
<b>BELLUCCI</b> , Canules aspiratrices	670
- Micro Ciseaux	554
<b>BENGOLEA</b> , Pincés hémostatiques	159
<b>BENIQUE</b> , Sondes	624
<b>BENNET</b> , Elevateurs	393
<b>BERGH</b> , Pincés à épiler les ciles	135
<b>BERGMANN</b> , Maillets chirurgicaux	430
<b>BERNHARD</b> , Pincés pour fixer les compresses	148
<b>BEYER</b> , Pincés-gouges	470
<b>BILLEAU</b> , Anses auriculaires	551

<b>BIRKETT</b> , Pincés hémostatiques	158
<b>BLAKE</b> , Utérines curettes	652
<b>BLOHMKE</b> , Pincés intestinales	174
<b>BLOUNT</b> , Elevateur	389, 393
<b>BLUMENTHAL</b> , Pincés-gouges	467
<b>BÖHLER</b> , Pincés-gouges	474
<b>BONNEY</b> , Pincés chirurgiques	131
<b>BOWLED-HENRY</b> , Ecarteurs	311
<b>BOWMAN</b> , Sondes	276
<b>BOYNTON</b> , Porte aiguilles	249, 261
<b>BRAUN</b> , Ciseaux chirurgicaux	
- Utérines pincés	629
<b>BRAUN-STADLER</b> , Ciseaux chirurgicaux	77
<b>BREISKY</b> , Valve vaginaux	638
<b>BROCK</b> , Ciseaux	41
- Pincés	109
- Porte aiguilles	233
<b>BROWN</b> , Pincés chirurgiques	125
<b>BRUENINGS</b> , Abaisse langues	4
<b>BRUNNER</b> , Aiguilles passe-fils	268, 505
- Costotomes	477
<b>BRUNS</b> , Curettes tranchantes	419
- Ciseaux à bandages	101
<b>BUCHWALD</b> , Abaisse langues	4
<b>BÜCHS</b> , Ecarteurs	311
<b>BUCK</b> , Marteaux percuteurs	3
<b>BUCK-GRAMCKO</b> , Elevateur	389
<b>BUCKLEY</b> , Ostéotomes	434
<b>BUELAU</b> , Trocarts	377
<b>BUMM</b> , Utérines curettes	654, 655
<b>BUNT</b> , Pincés à stérilisation	697
<b>BUSHE</b> , Curettes tranchantes	423

**C**

<b>CAPLAN</b> , Rhinologie	564
<b>CASPAR</b> , Curettes tranchantes	425
- Ecarteurs	304, 352, 353
- Ecarteurs	354, 355
- Instruments à mesurer	22
- Ostéotomes	433
- Pincés à biopsie	462, 463
<b>CASTANEDA</b> , Pincés vasculaires	182
<b>CASTROVIEJO</b> , Blépharostats	599
- Micro ecarteurs	591
- Micro ciseaux	603
- Micro pincés	596
- Micro spatules	592
- Porte aiguilles	238, 239, 240, 241, 242
- Instruments à mesurer	19, 20, 21
<b>CHADWICK</b> , Ciseaux délicate	46
<b>CHARNELY</b> , Ecarteurs	364
<b>CHEATTLE</b> , Pincés à stérilisation	697
<b>CHILD</b> , Pincés à tampons	8, 143
<b>CINELLI</b> , Rhinologie	567
<b>CITELLI</b> , Pincés-gouges	453
<b>CLEANLACT</b> , Lubrifiant pour instruments chirurgicaux	687
<b>CLOWARD</b> , Ecarteurs	345
- Ecarteurs vertébrale	356
<b>CLOWARD-CONTOUR</b> , Ecarteurs	329
<b>COAKLEY</b> , Curettes tranchantes	575
<b>COBB</b> , Rugines à périostomie	407
<b>COLIBRI</b> , Micro pincés	594
<b>COLLIN</b> , Costotomes	475
- Ecarteurs	346, 347, 348
- Pince hémostatiques	139, 143, 633
- Pincés tire langue	7
- Pincés pour agrafes	271
- Pincés à stérilisation	697
- Scies à amputation	414
<b>COLLIN-Standard</b> , Spéculum vaginaux	634
<b>CONVERSE</b> , Ecarteurs	288
- Porte aiguilles	250
- Tenotomes	28
<b>COOLEY</b> , Dilateurs	229
- Ecarteurs des cotes	324, 366
- Pincés vasculaires	212, 213, 214, 215, 216
<b>COOPER</b> , Aiguilles à ligatures	267
<b>COOK</b> , Blépharostats	599



<b>CORYLLOS</b> , Ecarteurs	315
<b>COTTLE</b> , Ecarteurs	284
- Elevateurs	396
- Ciseaux délicate	71
- Limes à os	409
- Marteaux chirurgicaux	430
- Osteotomes	438, 579
- Pincés anatomiques	129
- Rhinologie	565
- Rhinologie	559
- Instruments à écraser le cartilage	564
<b>COTTLE-MASING</b> , Ciseaux délicate	46
<b>COTTLE-NEIVERT</b> , Ecarteurs	565
<b>COTTLE-WALSHAM</b> , Rhinologie	563
<b>COUPLAND</b> , Canules aspiratrices	664, 665
<b>CRAFOORD</b> , Pincés à ligatures	163
<b>CRILE</b> , Pincés hémostatiques	151, 152
<b>CRILE-WOOD</b> , Porte aiguilles	243, 250, 252
<b>CRILE-MURRAY</b> , Porte aiguilles	243
<b>CUSCO</b> , Spéculum vaginaux	634
<b>CUSHING</b> , Ecarteurs	288, 289, 292
- Rugines	401
- Pincés à biopsie	461
- Pincés-gouges	469
- Pincés	121, 131
- Spatules flexible	326
<b>CUSHING-KOCHER</b> , Ecarteurs	292

**D**

<b>DALE</b> , Pincés vasculaires	217
<b>DANDY</b> , Ciseaux délicate	70
- Pincés chirurgicaux	151
- Pincés hémostatiques	151
<b>DAUBENSPECK</b> , Curettes tranchantes	423
<b>DAUTREY-MUNRO</b> , Osteotomes	581
<b>DAVIDSON</b> , Ecarteurs	316
<b>DAVIS</b> , Elevateur	382
- Pincés à stérilisation	696
<b>DAVIS-BOYLE</b> , Ecarteur buccal	541
<b>DAY</b> , Instrumentes pour l'otologie	551
<b>DE BAKEY</b> , Canules aspiratrices	664
- Dilatateurs vasculaires	226
- Ciseaux	73
- Porte aiguilles	255
<b>DE BAKEY-BAHNSON</b> , Pincés vasculaires	193
<b>DE BAKEY-BAINBRIDGE</b> , Pincés vasculaires	187
<b>DE BAKEY-CAROTIS</b> , Pincés vasculaires	180
<b>DE BAKEY-MOSQUITO</b> , Pincés vasculaires	185
<b>DE BAKEY-HARKEN</b> , Pincés vasculaires	200
<b>DE BAKEY-PEAN</b> , Pincés vasculaires	186
<b>DE BAKEY (POTTS-SMITH)</b> , Ciseaux	73
- Pincés	126, 127, 128, 132
- Pincés vasculaires	183, 203
<b>DE BAKEY-RANKIN</b> , Pincés vasculaires	185
<b>DE BAKEY-SATINSKY</b> , Pincés vasculaires	180, 198
<b>DEAN</b> , Ciseaux dentée	70
<b>DEAVER</b> , Ciseaux chirurgicaux	57
- Ecarteurs	320, 321
<b>DEJERINE</b> , Marteaux percuteurs	3
<b>DEMEL</b> , Aiguilles passe-fils	504
<b>DENIS-BROWN</b> , Ecarteurs	362
<b>DERF</b> , Porte aiguilles	243, 250
<b>DERRA</b> , Pincés vasculaires	189
<b>DESCHAMPS</b> , Aiguilles pour ligatures	262, 263, 264, 265, 266
<b>DESJARDINS</b> , Pincés pour les calculs renaux	623
- Bougies dilatatrices	628
<b>DESMARRES</b> , Bistouris	28
- Ecarteurs	287
- Pincés	129
<b>DIETER</b> , Pincés auriculaires	554
<b>DIETRICH</b> , Ciseaux	74
- Pincés vasculaires	205
- Micro Porte aiguilles	240
<b>DIFFENBACH</b> , Pincés Bulldog	177
<b>DIXON-LOVELACE</b> , Pincés Hémostatiques	158
<b>DINGMANN</b> , Ecarteur buccal	542
- Pincés pour chirurgie osseuse	485
<b>DITTEL</b> , Bougies dilatatrices	626

<b>DOCKHORN</b> , Ecarteurs	305
<b>DOLWICK-REICH</b> , Ecarteurs	337
<b>DOYEN</b> , Pincés pour fixer les compresses	146
- Ecarteurs	308, 363
- Pincés Hémostatiques	171
- Rugines à périostomie	404
- Sondes	275
- Instruments pour fibromes	645
- Valves vaginaux	637
<b>DOYEN-COLLIN</b> , Ecarteur buccal	6, 537
<b>DOYEN-JANSEN</b> , Ecarteur buccal	6, 537
<b>DOYEN-STILLE</b> , Ecarteurs	308
<b>DUBOIS</b> , Ciseaux chirurgicaux	77
<b>DUKE</b> , Trocarts	377
<b>DUNN-DAUTREY</b> , Ecarteurs	546
<b>DUPLAY</b> , Spéculum pour l'otologie	18
<b>DUPUY-WEISSE</b> , Aiguilles pour ligatures	262
<b>DURANTE</b> , Pincés	125
<b>DUVAL</b> , Pincés chirurgicaux	129
- Pincés atraumatiques	223
- Pincés Hémostatiques	145, 629
<b>DUVAL-COLLIN</b> , Pincés intestinales	629

**E**

<b>ECHLIN</b> , Pincés-gouges	470
<b>EDER</b> , Porte-coton	279
<b>EISELBERG-MATHIEU</b> , Porte aiguilles	249
<b>ELLIS</b> , Micro bistouris	589
<b>EPKER</b> , Osteotomes	578
<b>ESMARCH</b> , Ciseaux à bandages	101

**F**

<b>FAGER</b> , Elevateur	382
<b>FAHLBUSCH</b> , Micro ciseaux pour Rhinologie	555
<b>FARABEUF</b> , Ecarteurs	290
- Pincés-gouges	478
- Rugines à périostomie	402
<b>FARABEUF-LAMBOTTE</b> , Pincés-gouges	478
<b>FARREL</b> , Porte-coton	277
<b>FAULKNER</b> , Micro pincés pour l'otologie	596
<b>FAURE</b> , Pincés pour fixer les compresses	146
- Pincés à biopsie	648
<b>FEICHENFELD</b> , Pincés chirurgicaux	134
<b>FEIN</b> , Porte-coton	278
<b>FENO</b> , Spéculum vaginaux	656
<b>FERGUSSON</b> , Canules aspiratrices	669
- Pincés pour angiotribes	166
<b>FERRIS-SMITH-KERRISON</b> , Laminectomie	454, 455, 456, 457
<b>FERRIS-SMITH-CUSHING</b> , Laminectomie	458
<b>FIBULA</b> , Pincés pour chirurgie osseuse	479
<b>FINOCCHIETTO</b> , Ecarteurs	365
- Porte aiguilles	257
<b>FINSEN</b> , Ecarteurs	327
<b>FINSTERER</b> , Canules aspiratrices	664
<b>FOERSTER-BALLENGER</b> , Pincés à tampons	141
<b>FOMON</b> , Ecarteurs	284
- Ciseaux chirurgicaux	59, 70, 71
- Limes à os	410, 412, 572
- Rhinologie	567
<b>FRANKFELDT</b> , Porte-coton	279
<b>FRAZIER</b> , Canules aspiratrices	669, 674, 680
- Ecarteurs	350
<b>FREER</b> , Elevateur	395
- Scalpel	434
- Bistouris	572
<b>FRENZEL</b> , Abaisse langues	4
<b>FRIEDMANN</b> , Pincés-gouges	467

**G**

<b>GABON</b> , Chirurgie osseuse	586
<b>GALLAHER</b> , Limes à os	408
<b>GARRETT</b> , Dilatateurs v asculaires	227
<b>GELLHORN</b> , Pincés à biopsie	647
<b>GELPI</b> , Ecarteurs	328



<b>GELPI-LOKTITE</b> , Ecarteurs	329
<b>GELPI-SEILETZ</b> , Ecarteurs	329
<b>GEMINI</b> , Pincés hemostatiques à ligatures	162
<b>GENTOFT</b> , Spéculum vaginal	656
<b>GERALD</b> , Pincés chirurgicaux	123
<b>GERALD-BROWN</b> , Pince chirurgicaux	123
<b>GERSTER</b> , Chirurgie osseuse	487
<b>GERSTER-LOWMAN</b> , Chirurgie osseuse	487
<b>GIDEF</b> , Pincés hemostatiques	150
<b>GIERTZ-STILLE</b> , Costôtomes	477
<b>GIGLI</b> , Scies à amputation	414
<b>GIL-VERNET</b> , Ecarteurs	293
<b>GILLIES</b> , Ecarteurs	283
- Porte aiguilles	247, 253
<b>GLASSMAN</b> , Ciseaux chirurgicaux	52
<b>GLOVER</b> , Pincés Bulldog	179, 180
- Pincés vasculaires	207
<b>GOLDMAN-FOX</b> , Ciseaux chirurgicaux	49, 50, 80, 84
<b>GOELET</b> , Ecarteur	291
<b>GORNEY</b> , Ciseaux chirurgicaux	68
- Canules aspiratrices	667
<b>GOSSET</b> , Ecarteurs abdominaux	357
<b>GOURDET</b> , Uterines curettes	651
<b>GRAEFE</b> , Ciseaux délicate	46
- Pincés pour Micro chirurgie	114, 129
- Micro ecarteurs	589, 590
- Micro bistouris	27, 590
<b>GRAY</b> , Pincés à ligatures	164
<b>GRAVE</b> , Spéculum vaginal	634
<b>GREGORY</b> , Pincés vasculaires	207
<b>GREENE</b> , Ecarteurs	311
<b>GROSS</b> , Pincés hemostatiques	139, 141
<b>GRUENWALD</b> , Pincés chirurgicaux	133
<b>GUILLIEN</b> , Canules aspiratrices	667
<b>GUSBERG</b> , Curette pour biopsie endocervicales	646
<b>GUTHRIE</b> , Ecarteurs	283
<b>GUYON</b> , Bougies dilatatrices	628
- Sondes	624
- Pincés pour pédicules rénaux	175
- Pincés utérines	629

**H**

<b>HABERER</b> , Spatules malléable	326
<b>HAGLUND</b> , Appareils plâtrés	533
<b>HALLE</b> , Curettes tranchantes	422
<b>HALSEY</b> , Porte aiguilles	243, 250
<b>HALSTED</b> , Pincés hemostatiques	150, 152
<b>HALSTED-MOSQUITO</b> , Pincés hemostatiques	149, 152
<b>HANK</b> , Uterines Dilatateurs	641
<b>HARRINGTON</b> , Ecarteurs	317
<b>HARTMANN</b> , Abaisse langue	544
- Canules aspiratrices	676, 677
- Diapasons	5
- Porte coton	278
- Pincés-gouges	469
- Pincés pour polypes auriculaires	552, 553
- Spéculum nasaux	18, 560, 561
<b>HARTMANN-BABY-MOSQUITO</b> , Pincés hemostatiques	149
<b>HAYES</b> , Pincés atraumatiques	218
<b>HEANEY</b> , Porte aiguilles	257
<b>HEANEY-HEGAR</b> , Porte aiguilles	244
<b>HEAT</b> , Marteaux chirurgicaux	431
<b>HEGAR</b> , Uterines dilateur	639, 641
- Porte aiguilles	244, 251
<b>HEGAR-MAYO-SEELEY</b> , Porte aiguilles	245, 252
<b>HEGENBARTH</b> , Pincés chirurgiques	271
<b>HEILDELBERG</b> , Porte coton	278
<b>HEISS</b> , Pincés hemostatiques	158
<b>HEISTER</b> , Ecarteur buccal	6, 537
<b>HEMINGWAY</b> , Curettes tranchantes	415
<b>HENAHAN</b> , Rugines	401
<b>HENLEY</b> , Ecarteurs	344
<b>HENNIG</b> , Appareils plâtrés	533
<b>HEPARIN</b> , Canules aspiratrices	682
<b>HEYMANN</b> , Ciseaux chirurgicaux	71
<b>HEYMANN-KNIGHT</b> , Ciseaux chirurgicaux	71
<b>HIBBS</b> , Ecarteurs	297
- Osteotome	439

<b>HOHMANN</b> , Elevateur	391, 394
<b>HOLZBACH</b> , Ecarteur	349
<b>HÖPFNER</b> , Pincés intestinales	174
<b>HOPT</b> , Pincés vasculaires	219
<b>HOUSE</b> , Canules aspiratrices	672
<b>HOWARD</b> , Limes à os	408, 570
<b>HOWARTH</b> , Rugines	397
<b>HUNTER</b> , Pincés à échardes	134
<b>HURD</b> , Rugines	397

**I**

<b>INGE</b> , Ecarteurs vertébrale	356
<b>IRIS</b> , Ciseaux délicate	44, 81, 83, 84, 99
<b>ISRAEL</b> , Ecarteurs	298
<b>ITARD</b> , Canules aspiratrices	677

**J**

<b>JACKSON-TESSIER</b> , Ciseaux à os	476
<b>JACOBSON</b> , Curettes tranchantes	416
- Micro Ciseaux	40
- Perforateurs à os	501, 502, 503, 527
- Porte aiguilles	235, 241
<b>JACOBSON-UNIVERSAL</b> , Perforateurs à os	527
<b>JAMESON</b> , Ciseaux délicate	47
<b>JAMESON-WERBER</b> , Ciseaux délicate	47
<b>JANSEN</b> , Curettes tranchantes	416
- Ecarteurs	327
- Pincés à os	469
- Pincés	133
- Rugines	402
<b>JANSEN-LEUER</b> , Pincés à os	468
<b>JAVID</b> , Pincés vasculaires	222
<b>JONES</b> , Pincés pour fixer les compresses	146
- Pincés hemostatiques	139
<b>JOSEPH</b> , Ecarteurs	284
- Ciseaux	58
- Limes à os	408
- Limes nasaux	573, 574
- Rugines	401
<b>JUDD-MASSON</b> , Ecarteurs vésicaux	369

**K**

<b>KALLMORGEN</b> , Valves vaginaux	635
<b>KELLY</b> , Ecarteurs	310
- Ciseaux chirurgiques	53, 85
- Pincés hemostatiques	155
<b>KERN</b> , Pincés à os	486
<b>KERPEL</b> , Curettes tranchantes	418
<b>KERSHNER</b> , Ecarteur pour l'oftalmologie	598
<b>KERRISON</b> , Laminectomie	453
<b>KERRISON-JACOBY</b> , Laminectomie	455
<b>KEVORKIAN</b> , Pincés à biopsie	650
<b>KEY-HORSLEY</b> , Pincés à os	475
<b>KEYES</b> , Tréphines cutanées	28, 491
<b>KILLIAN</b> , Canules aspiratrices	678
- Ciseaux nasaux	72
- Ciseaux pour rhinologie	564
- Rhinologie	565
- Spéculum nasaux	560, 561
<b>KILLIAN-KLAUS</b> , Osteotomes	565
<b>KILNER</b> , Ciseaux	47, 52, 85
- Porte aiguilles	256
<b>KILNER-DOUGHTY</b> , Ecarteur buccal	540
<b>KIMURA</b> , Micro spatules	592
<b>KIRSCH</b> , Ecarteurs	304
<b>KIRSCHNER</b> , Ecarteurs	361, 304
<b>KLIMA-ROSEGGER</b> , Aiguilles pour biopsie	377
<b>KOCHER</b> , Aiguilles à ligatures	267
- Ecarteurs	292, 294, 296, 301, 305, 307
- Pincés hemostatiques	153, 155, 157
- Pincés intestinales	172, 173
- Sondes	269
<b>KOCHER-LAGENBECK</b> , Ecarteurs	300
<b>KOCHER-OCHSNER</b> , Ciseaux chirurgicaux	154



<b>KOENIG</b> , Sondes	269
<b>KOERTE</b> , Ecarteurs	323
<b>KÖNIG</b> , Elevateur	381
<b>KRAUSE</b> , Rhinologie	562
- Trocarts	375
<b>KRESSNER</b> , Pincés nasaux	563
<b>KRISTELLER</b> , Spéculum et valves vaginaux	636
<b>KROENIG</b> , Abaisse langue	4
<b>KRONECKER</b> , Aiguilles à ligatures	262
<b>KÜHNE</b> , Pincés à épiler les cils	135
<b>KÜNTSCHER</b> , Broches	496
- Chirurgie osseuse	500

**L**

<b>LA FORCE</b> , Micro bistouris	589
<b>LA GRANGE</b> , Ciseaux chirurgicaux	50, 80
<b>LAHEY</b> , Ecarteurs	288
<b>LAMBERT-KAY</b> , Pincés vasculaires	210
<b>LAMBOTTE</b> , Ostéotomes	437
- Pincés à os	478
- Rugines	404
<b>LANDAU</b> , Valves vaginaux	637
<b>LANDOLT</b> , Manches de bistouris	34
- Pincés à biopsie	465
<b>LANE</b> , Tournevis	528
- Pincés pour chirurgie osseuse	486
<b>LANGE</b> , Ecarteurs	289
<b>LANGENBECK</b> , Porte aiguilles	259
- Ecarteurs	299
- Elevateurs	395
- Rugines	402
- Scies à amputation	414
<b>LANGENBECK-RYDER</b> , Porte aiguilles	259
<b>LAWRENCE</b> , Pincés hemostatiques et à ligatures	165
<b>LEES</b> , Pincés vasculaires	209
<b>LEKSELL</b> , Pincés-gouges	470
<b>LELAND-JONES</b> , Pincés vasculaires	215
<b>LEMPERT</b> , Pincés-gouges	468
<b>LERICHE</b> , Pincés hemostatiques	151
<b>LEWIN</b> , Pincés à os	479
<b>LEWIS</b> , Limes à os	409
- Limes nasaux	573
<b>LEXER</b> , Ciseaux chirurgicaux	66, 95
- Ostéotomes	446, 448
- Ostéotomes	445, 446
<b>LEVIS</b> , Fonendoscopes	10
<b>LICHTENBERG</b> , Porte aiguilles	261
<b>LICHTWITZ</b> , Trocarts	375
<b>LIEBERMANN-TENNANT</b> , Ecarteurs pour l'oftalmologie	598
<b>LINDEMANN</b> , Scies à amputation	414
<b>LISTER</b> , Ciseaux à bendages	101
- Pincés hemostatiques	139
<b>LISTER-BURCH</b> , Blépharostats	599
<b>LISTON</b> , Pincés à os	473
<b>LISTON-STILLE</b> , Pincés à os	475
<b>LITTAUER</b> , Pincés auriculaires	552
- Pincés à épiler les cils	135
<b>LITTLER</b> , Ciseaux délicate	59
<b>LITTLEWOOD</b> , Pincés uterines	644
<b>LOCHART</b> , Sondes	275
<b>LOCKLIN</b> , Ciseaux délicate	48, 53
<b>LÖFFEL</b> , Rhinologie	558
<b>LOGAN</b> , Ecarteurs	327
<b>LORENZ</b> , Ciseaux à bendages	101
<b>LORNA</b> , Pincés pour fixer les compresses	147
<b>LOUTE</b> , Tendeur serre fils	499
<b>LOVE</b> , Ecarteurs	289
<b>LOVE-GRUENWALD</b> , Pincés à biopsie	460, 461
<b>LUCAE</b> , Diapasons	5
- Marteaux chirurgicaux	429
- Pincés chirurgicaux	133
- Instrumentes pour l'otologie	551
<b>LUER</b> , Pincés à os	467
<b>LUER-KÖRTE</b> , Curettes uterines	651
<b>LUER-LOCK</b> , Manches porte canules	681
<b>LUER-STILLE</b> , Pincés à os	469, 471, 472

**M**

<b>MAGILL</b> , Canules aspiratrices	678
- Pincés à intubation	7
<b>MAIER</b> , Pincés à tampons	142, 633
<b>MALTZ</b> , Limes nasaux	574
<b>MARKHAM-MEYERDING</b> , Ecarteurs	336
<b>MARTIN</b> , Ecarteurs	314
- Pincés pour chirurgie osseuse	485
- Porte coton	277
- Histéromètres	642
<b>MARTINI</b> , Curettes tranchantes	416
<b>MASING</b> , Elevateur	396
<b>MASSON</b> , Porte aiguilles	245, 257
<b>MATHIEU</b> , Ecarteurs	290
- Spéculum pour rectum	369
- Porte aiguilles	248, 249, 260
- Valves vaginaux	635
<b>MAYO</b> , Ciseaux chirurgicaux	64, 65, 82, 96
- Histéromètres malléables	642
- Spatules	4
- Pincés à stérilisation	697
<b>MAYO-HARRINGTON</b> , Ciseaux	75
<b>MAYO-HEGAR</b> , Porte aiguilles	244, 251, 252
<b>MAYO-HEGAR-HEANEY</b> , Porte aiguilles	256
<b>MAYO-LEXER</b> , Ciseaux chirurgicaux	96
<b>MAYO-NOBLE</b> , Ciseaux chirurgicaux	64
<b>MAYO-RUSSIAN</b> , Pincés	125
<b>MAYO-STILLE</b> , Ciseaux	67, 94
<b>MC DONALD</b> , Elevateur	397
<b>MC INTOSH</b> , Laringoscopes	11, 14, 16
<b>MC IVOR</b> , Ecarteurs buccal	541
<b>MC KENTY</b> , Elevateur	397
<b>MC KESSON</b> , Canules aspiratrices	660
<b>MC PHERSON</b> , Micro pincés	595, 596
<b>MEAD</b> , Elevateur	395
- Marteaux chirurgicaux	429
- Pincés à os	467
<b>MEEKER</b> , Pincés hemostatiques et ligatures	165
<b>MELLINGER</b> , Blépharostats	599
<b>METZENBAUM</b> , Ciseaux	59, 60, 61, 81, 84, 89, 90, 91, 92, 99
<b>MEYERDING</b> , Ecarteurs	312, 335
<b>MICHEL</b> , Pincés pour agrafes	271
<b>MICRO-HALSTEAD</b> , Pincés hemostatiques	149
<b>MICRO-HARTMANN</b> , Pincés pour l'otologie	552
<b>MICRO-IRIS</b> , Ciseaux délicate	44
<b>MICRO-RYDER</b> , Porte aiguilles	258
<b>MICRO-VASCULAR</b> , Porte aiguilles	255
<b>MIDDLELDORPF</b> , Ecarteurs	306
<b>MIKULICZ</b> , Ecarteurs	322, 323
- Pincés hemostatiques	158
<b>MILLER</b> , Laringoscopes	12, 15, 16
- Limes à os	408, 570
<b>MILLIGAN</b> , Elevateur	382
<b>MILLIN</b> , Ecarteurs vésicaux	369
<b>MINI-FRIEDMANN</b> , Pincés à os	466, 467
<b>MINI-GILLIES</b> , Porte aiguilles et ciseaux	247, 253
<b>MINI-HOHMANN</b> , Elevateur	389
<b>MINI-LAMBOTTE</b> , Ostéotomes	437, 438
<b>MINI-LEXER</b> , Ostéotomes	440, 445
<b>MINI-OLSEN-HEGAR</b> , Porte aiguilles et ciseaux	246
<b>MINI-ROUX</b> , Ecarteurs	291
<b>MINNESOTA</b> , Ecarteurs	539
<b>MISKIMON</b> , Ecarteurs	340
<b>MIXTER</b> , Pincés hemostatiques	164
<b>MOLLISON</b> , Ecarteurs	335
<b>MOLT</b> , Ecarteur buccal pour enfants	537
- Rugines	401
<b>MORRIS-DE BAKEY</b> , Pincés vasculaires	195
<b>MORSE</b> , Ecarteurs del cotes	367
<b>MÜNCHEN</b> , Curettes pour biopsie	646
<b>MUSEUX</b> , Pincés uterines	644

**N**

<b>NEGUS</b> , Pincés hemostatiques et ligatures	165
<b>NEGUS-GUEDEL</b> , Laringoscopes	13, 16
<b>NELATON</b> , Sondes	275



**NELSON**, Trocarts 374  
**NELSON-METZENBAUM**, Ciseaux chirurgicaux 62, 93  
**NEUBÜSER**, Pincés pour tubes 645  
**NEUMANN**, Ciseaux délicate 50  
**NICOLA**, Micro pincés pour rhinologie 555  
**NOVAK**, Curettes aspiratrices 646  
**NOYES**, Micro ciseaux 39, 601  
**NUBOER**, Canules aspiratrices 666

**O**

**OBWEGESER**, Aiguilles pour ligatures 489  
 - Ecarteurs 302, 303, 545  
 - Ostéotomes 437, 449, 450, 568  
 - Rugines 398, 399, 400  
**OCHSNER**, Pincés vasculaires 205  
 - Trocarts 374  
**OLDBERG**, Pincés à biopsie 465  
**OLIVECRONA**, Dissecteurs 383  
 - Pincés à os 469  
 - Spatules flexible 326  
**OLLIER**, Ecarteurs 297  
**OLSEN-HEGAR**, Porte aiguilles avec ciseaux 246, 253  
**OMBREDANNE**, Marteaux chirurgicaux 431  
**ORINGER**, Ecarteur buccal 538  
**OSHIKA-FAULKNER**, Micro pincés pour l'oftalmologie 596  
**OVERHOLT**, Pincés à ligatures 161  
**OVERHOLT-GEISSENDORFER**, Pincés à ligatures 161

**P**

**PAPAVERO-CASPAR**, Spéculum nasaux 559  
**PAPAVERO-HARTMANN**, Spéculum nasaux 559  
**PARAMETRIUM**, Ciseaux chirurgicaux 97  
**PARKER-LANGENBECK**, Ecarteurs 290  
**PARTSCH**, Ostéotomes 435, 436  
**PATELLA**, Pincés à os 481  
**PAYR**, Pincés intestinales 174  
 - Sondes 269  
**PEAN**, Pincés hemostatiques 150, 153, 156  
**PEAN-MURPHY**, Pincés hemostatiques 140  
**PECK-JOSEPH**, Ciseaux chirurgicaux 84  
**PEDERSON**, Spéculum vaginaux 634  
**PELTON-CRANE**, Canules aspiratrices 679  
**PENFIELD**, Dissecteurs 385  
**PERRY**, Pincés chirurgicaux 115  
**PERTHES**, Instruments à perforer alènes 490  
**PHILIPS**, Tournevis 528  
**PIERCE**, Trocarts 375  
**PIERSE**, Micro pincés 594  
**PLESTER**, Canules aspiratrices 669  
 - Ecarteurs 333, 334  
**POOLE**, Canules aspiratrices 675  
**POTTS**, Pincés vasculaires 206, 208  
**POTTS-SMITH**, Ciseaux vasculaires 73  
 - Pincés chirurgicaux 120, 131  
**POTTS-YASARGIL**, Micro ciseaux 40  
**POZZI**, Pincés uterines 643  
**PRATT**, Uterines dilatateur 640  
**PRICE-THOMAS**, Pincés vasculaires 224  
**PROST**, Blépharostats 599  
**PUTTI**, Limes à os 413

**Q**

**QUINBY**, Ciseaux 46  
**QUINKE**, Aiguilles à biopsie 378, 684

**R**

**RADOLF**, Pincés pour extraire les ongles 488  
**RAGNEL-DAVIS**, Ecarteurs 288  
**RAMPLEY**, Pincés a tampons 142, 633  
**RAMUS**, Pincés à os 548  
**RANDALL**, Curettes aspiratrices 646  
 - Pincés pour les calculs renaux 623

**RANKIN**, Pincés hemostatiques 155  
**RECAMIER**, Curettes uterines 653  
**REDON**, Aiguille d'introduction 270  
**REILL**, Micro porte aiguilles 610  
 - Pincés à os 480  
**REVERDIN**, Spatules 326  
**REYNOLDS**, Ciseaux chirurgicaux 51  
**RICARD**, Ecarteurs 349  
**RICHARDSON**, Ecarteurs 309  
**RICHARDSON-EASTMAN**, Ecarteurs 309  
**ROBB**, Elevateurs 384  
**ROBIN**, Pincés pour fixer les compresses 147  
**ROCHARD**, Ecarteurs 363  
**ROCHESTER-CARMALT**, Pincés hemostatiques 171  
**ROCHESTER-PEAN**, Pincés hemostatiques 154, 162  
**RODHOIL**, Lubrifiant pour instruments chirurgicaux 687  
**ROGGE**, Pincés à stérilisation 696  
**ROSEN**, Canules aspiratrices 681  
**ROSER-KÖNIG**, Acarteur buccal 6, 537  
**ROSS**, Ecarteurs 319  
**ROTAN**, Canules aspiratrices 671  
**RÖTTGEN-RUSKIN**, Pincés à os 471  
**ROUX**, Ecarteurs 291  
**ROUX-MAGNUS**, Ecarteurs 291  
**ROWE**, Pincés à os 550  
**RUBIN**, Pincés nasaux 563  
**RUMEL**, Pincés hemostatiques et ligatures 163  
**RUSKIN-STILLE**, Pincés à os 470  
**RUSKIN-LISTON**, Pincés à os 474  
**RUSSIAN**, Pincés chirurgicaux 125  
**RYDER**, Porte aiguilles 258  
**RYDEL-SEIFER**, Diapasons 5

**S**

**SACHS**, Elevateur 382  
**SALZBURG**, Elevateur 396  
**SANDERS-BROWN**, Aiguilles à ligatures 489  
**SANTULLI**, Pince Bulldog 180  
**SAROT**, Porte aiguilles 254  
**SATINSKY**, Ciseaux 69  
 - Pincés vasculaires 225  
**SAUERBRUCH**, Costôtomes 477  
 - Ecarteurs 301, 315  
 - Pincés à os 472  
 - Pincés à stérilisation 697  
**SAUERBRUCH-FREY**, Costôtomes 477  
**SAUG-RASPATORIUM**, Canules aspiratrices 667  
**SCHAEDEL**, Pincés pour fixer les compresses 146  
**SCHEDÉ**, Curettes tranchantes 419  
**SCHLESINGER**, Laminectomie 456  
**SCHMID**, Aiguilles vasculaires malléables 228, 681  
**SCHMIEDEN**, Aiguilles à ligatures 267  
**SCHMIEDEN-DICK**, Aiguilles à ligatures 267  
**SCHMIEDEN-TAYLOR**, Ciseaux chirurgicaux 70  
**SCHNEIDER**, Rugines 402  
**SCHRÖDER**, Curettes tranchantes 424  
 - Pincés uterines 643  
**SCHUBERT**, Pincés à biopsie 649  
**SCHUMACHER**, Elevateur 392  
 - Costôtomes 477  
 - Pincés à biopsie 650  
**SCOVILLE**, Ecarteurs 292, 350, 351  
**SCOVILLE-HAVERFIELD**, Ecarteurs 350  
**SEDILLOT**, Rugines 397  
 - Rugines 402  
**SELDIN**, Elevateur 395  
**SELMAN**, Pincés hemostatiques 125  
**SEMB**, Rugines 403  
**SEMKEN**, Pincés chirurgicaux 115, 120, 130  
**SENN-GREEN**, Ecarteurs 287  
**SENN-MILLER**, Ecarteurs 288  
**SEPTUN-NADEL**, Aiguilles-Canules 680  
**SHAPLEIGH**, Curettes pour l'otologie 551  
**SIEBENMANN**, Canules aspiratrices 677  
**SIEBOLD**, Ciseaux chirurgicaux 78  
**SIGMOID-NOTCH**, Rugines-Ecarteurs 388, 547  
**SILVER**, Rhinologie 566  
**SIMON**, Curettes tranchantes 424



- Ecarteurs	314
<b>SIMPSON</b> , Hystéromètres	642
<b>SIMPSON-BRAUN</b> , Forceps uterines	656
<b>SIMS</b> , Ciseaux chirurgicaux	75, 76, 98
- Hystéromètres	642
<b>SINGLEY-TUTTLE</b> , Pincers anatomiques	125
<b>SMITH</b> , Ciseaux coupe-fils métalliques	102
<b>SMITH-BUIE</b> , Ecarteurs	370
<b>SMITH-PETERSEN</b> , Ostéotomes	442
<b>SNELLEN</b> , Anses pour oftalmologie	591
<b>SPENCER</b> , Ciseaux à ligatures	100
<b>SPLIT</b> , Ostéotomes curves	578
<b>SPURLING</b> , Pincers à biopsie	461
<b>STACKE</b> , Sondes	276
<b>STAMMBERGER</b> , Pincers pour rhinologie	556
<b>STEINHÄUSER</b> , Rugines	400
<b>STEINMANN</b> , Broches filiformes	496, 497
<b>STELLBRINK</b> , Pincers à os	466
<b>STERNBERG</b> , Ecarteurs	290, 539
<b>STEVENS</b> , Ciseaux délicate	51
- Porte aiguilles	242
<b>STIEGLITZ</b> , Pincers à échardes	134
<b>STILLE</b> , Ciseaux chirurgicaux	67
- Ostéotomes	441
- Pincers à os	471
- Pincers chirurgicaux	118
- Appareils plâtrés	533
- Pincers rénaux	175
- Porte aiguilles	249
- Pincers uterines	629
- Gouges	441
<b>STILLE-BARRAYA</b> , Pincers chirurgicaux	124
<b>STRULLY</b> , Ciseaux chirurgicaux	69
<b>STRUYCKEN</b> , Pincers pour rhinologie	556
<b>SUBRAMANIAN</b> , Pincers vasculaires	221
<b>SUBRAMANIAN-MINIATURE</b> , Pincers vasculaires	221
<b>SWEDESH mod.</b> , Porte aiguilles	254
<b>SYPERT</b> , Ostéotomes	433
- Pincers à biopsie	464

**T**

<b>TAKAHASHI</b> , Pincers à biopsie	460
<b>TAYLOR</b> , Ecarteurs	351
- Elevateur	394
- Marteaux percuteurs	3
- Pincers chirurgicaux	131
<b>TERRIER</b> , Pincers hemostatiques	139
<b>TESSIER</b> , Curettes tranchantes	425
- Ecarteurs	313, 545
- Ostéotomes	443, 583
- Pincers à os	585
- Chirurgie osseuse	549
<b>THOMS-GAYLOR</b> , Pincers à biopsie	647
<b>TISCHLER-MORGAN</b> , Pincers à biopsie	650
<b>TOBOLD</b> , Abaisse langue	544
<b>TÖNNIS</b> , Ciseaux chirurgicaux	63
- Porte aiguilles	247, 259
<b>TÖNNIS-ADSON</b> , Ciseaux chirurgicaux	63, 97
<b>TÖNNIS-RYDER</b> , Porte aiguilles	259
<b>TROELTSCH</b> , Pincers anatomiques	133
<b>TROEMNER</b> , Marteaux percuteurs	3
<b>TROUTMAN</b> , Micro pincers pour oftalmologie	596
- Micro ciseaux pour oftalmologie	603
<b>TUBBS</b> , Ecarteurs	229
<b>TUFFIER</b> , Ecarteur des cotes	367
- Spatules malléable	326
<b>TUOHY</b> , Aiguilles à biopsie	378, 684

**U**

<b>UFFENORDE</b> , Curettes tranchantes	418
<b>ULRICH</b> , Chirurgie osseuse	484
<b>UNIVERSAL</b> , Porte coton	277
- Trocarts	376
<b>URO-TANGENTIAL</b> , Pincers vasculaires	220

**V**

<b>VALLEIX</b> , Hystéromètres	642
<b>VAN DOREN</b> , Pincers à biopsie	648
<b>VANNAS</b> , Micro ciseaux	39, 43, 600
<b>VARADAY</b> , Stripper à anneau	228
<b>VERBRUGGE</b> , Pincers à os	482
<b>VERES</b> , Aiguilles pour biopsie	684
<b>WISE</b> , Micro pincers	107
<b>VOLKMANN</b> , Curettes tranchantes	417, 420
- Ecarteurs	294, 295
<b>VOLLMAR</b> , Stripper	228

**W**

<b>WAGNER</b> , Chirurgie osseuse	500
- Pincers à biopsie	464
<b>WALDMANN</b> , Ciseaux à épisiotomie	79
<b>WALLICH</b> , Curettes uterines	652
<b>WALTON</b> , Ecarteurs	336
<b>WALTON-POOLE</b> , Canules aspiratrices	675
<b>WANGENSTEIN</b> , Pincers chirurgicaux	131
- Porte aiguilles	245, 252
<b>WASSMUND</b> , Ecarteur	299
<b>WEBER</b> , Anses pour oftalmologie	591
- Pincers vasculaires	204
<b>WEBSTER</b> , Porte aiguilles	250
<b>WECKER</b> , Micro spatules	590
- Micro ciseaux	600
<b>WEIL-BLAKESLEY</b> , Pincers à biopsie	459
<b>WEITLANER</b> , Ecarteur	330, 331, 332, 338
<b>WELLER</b> , Ciseaux chirurgicaux	78
<b>WERTHEIM</b> , Ciseaux chirurgicaux	58, 98
- Pincers rénaux	176, 630, 631
- Porte aiguilles	256
<b>WEST</b> , Elevateur	395
<b>WESTCOTT</b> , Micro ciseaux	39, 601
<b>WHERTEIMER</b> , Canules aspiratrices	674
<b>WHITEHEAD-JENNINGS</b> , Ecarteur buccal	6, 540
<b>WIEDER</b> , Abaisse langue	544
<b>WIKSTROEM</b> , Pincers à ligatures	164
<b>WILDE</b> , Rhinologie	562
<b>WILDER</b> , Dilatateur pour oftalmologie	592
<b>WILLIAMS</b> , Blépharostats	599
<b>WILLIGER</b> , Curettes tranchantes	416, 422
- Elevateur	381
- Marteaux chirurgicaux	429
<b>WINTER</b> , Pincers à faux germes	632
<b>WOLFF</b> , Appareils plâtrés	532
<b>WULLSTEIN</b> , Canules aspiratrices	665, 681
- Ecarteurs	330
- Micro curettes	554

**Y**

<b>YANKAUER</b> , Canules aspiratrices	662
<b>YASARGIL</b> , Canules aspiratrices	668
- Micro ciseaux	40, 43
- Pincers à biopsie	465
- Micro pincers	110
- Porte aiguilles	236, 237
<b>YASARGIL-NICOLA</b> , Micro pincers pour rhinologie	555
<b>YOUNG</b> , Pincers tire-langue	8, 143

**Z**

<b>ZAUFAL-JANSEN</b> , Pincers à os	470
<b>ZIEGLER</b> , Micro bistouris	27, 589
<b>ZIELINSKY</b> , Instruments à mesurer	22
<b>ZIELKE</b> , Ostéotomes	448

**A**

<b>ADLERKREUTZ</b> , Pinzas quirúrgicas	124
<b>ADSON</b> , Cánulas aspiradoras	674
- Separadores	338, 339, 341, 343
- Periostotomos	401
- Pinzas de disección	116, 130
<b>ADSON-BROWN</b> , Pinzas quirúrgicas	116
<b>ALAN-PARKS</b> , Separadores	370
<b>ALDERDYCE</b> , Elevadores	395
<b>ALEXANDER</b> , Pinzas para huesos	468
- Pinzas para biopsia	649
<b>ALLIS</b> , Pinzas para coger las encías	145, 223
<b>ALLISON</b> , Separadores	318
<b>ALM</b> , Separadores	327
<b>ANDERSON-ADSON</b> , Separadores	335
<b>ANDREWS-PYNCHON</b> , Cánulas aspiradoras	662
<b>ANEL</b> , Instrumentos oculares	593
<b>ANGLE</b> , Alicates para cortar alambre	510
<b>ARKANSAS</b> , Accesorios para el reafilado	688
<b>ARRUGA</b> , Portaagujas	261
- Instrumentos oculares	592
<b>ASH</b> , Rinología	563
<b>AUFRICHT</b> , Rinología	565
- Limas para huesos	409
<b>AUSTIN</b> , Pinzas quirúrgicas	115

**B**

<b>BABBUSH</b> , Elevadores	395
<b>BABCOCK</b> , Pinzas intestinales	144, 223
- Sondas para várices maleables	680
<b>BABINSKY</b> , Martillos de percusión	3
<b>BABY-ADSON</b> , Pinzas hemostáticas y para ligaduras	160
<b>BABY-ALLIS</b> , Pinzas para coger las encías	145
<b>BABY-CRILE</b> , Pinzas hemostáticas	152
<b>BABY-CRILE-WOOD</b> , Portaagujas	250
<b>BABY-COLLIN</b> , Separadores	346
<b>BABY-FINOCCHIETTO</b> , Separadores	365
<b>BABY-METZENBAUM</b> , Tijeras para cirugía general	59
<b>BABY-MIXTER</b> , Pinzas hemostáticas	160
<b>BABY-MORSE</b> , Separadores costales	367
<b>BABY-WEITLANER</b> , Separadores	330
<b>BABY-YANKAUER</b> , Cánulas aspiradoras	662
<b>BACKHAUS</b> , Pinzas de campo	146
<b>BAILEY</b> , Separadores costales	368
<b>BAINBRIDGE</b> , Pinzas intestinales	166
<b>BAKES</b> , Dilatadores para conducto biliar	625
<b>BALFOUR</b> , Separadores abdominales	358, 359, 360
<b>BALFOUR-BABY</b> , Separadores abdominales	358
<b>BALLENGER</b> , Rinología	569
- Rinología	565
<b>BARON</b> , Cánulas aspiradoras	670
<b>BARR</b> , Separadores rectales	370
<b>BARRAQUER</b> , Bléfarostatos	598
- Pinzas finas	595
- Micro portaagujas	609, 610, 611
- Pinzas depilatorie	135
- Portaagujas	234
<b>BARTH</b> , Cucharillas cortantes	416
<b>BAUMGARTNER</b> , Portaagujas para ligaduras	511
<b>BEACHAM</b> , Amniótomo para la vesícula amniótica	643
<b>BECK</b> , Pinzas vasculares	207
<b>BECKMANN</b> , Adenotomes	576
- Separadores	342
<b>BECKMANN-EATON</b> , Separadores	343
<b>BEEBE</b> , Tijeras para cortar alambre	103
<b>BEER</b> , Pinzas depilatorie	135
<b>BELLUCCI</b> , Cánulas aspiradoras	670
- Micro tijeras	554
<b>BENGOLEA</b> , Pinzas hemostáticas	159
<b>BENIQUE</b> , Catéteres	624
<b>BENNET</b> , Elevadores	393
<b>BERGH</b> , Pinzas depilatorie	135
<b>BERGMANN</b> , Martillos quirúrgicos	430
<b>BERNHARD</b> , Pinzas de campo	148
<b>BEYER</b> , Pinta para huesos	470
<b>BILLEAU</b> , Ansa auriculares	551

<b>BIRKETT</b> , Pinzas hemostáticas	158
<b>BLAKE</b> , Curetas uterinas	652
<b>BLOHMKE</b> , Pinzas intestinales	174
<b>BLOUNT</b> , Elevadores	389, 393
<b>BLUMENTHAL</b> , Pinzas para huesos	467
<b>BÖHLER</b> , Pinzas para huesos	474
<b>BONNEY</b> , Pinzas quirúrgicas	131
<b>BOWLED-HENRY</b> , Separadores	311
<b>BOWMAN</b> , Estiletes	276
<b>BOYNTON</b> , Portaagujas	249, 261
<b>BRAUN</b> , Tijeras quirúrgicas	
- Pinzas uterinas	629
<b>BRAUN-STADLER</b> , Tijeras quirúrgicas	77
<b>BREISKY</b> , Valvas vaginales	638
<b>BROCK</b> , Tijeras	41
- Pinzas finas	109
- Portaagujas	233
<b>BROWN</b> , Pinzas quirúrgicas	125
<b>BRUENINGS</b> , Bejalenguas	4
<b>BRUNNER</b> , Aguja para ligaduras	268, 505
- Costótomos	477
<b>BRUNS</b> , Curetas cortante	419
- Tijeras para vendajes	101
<b>BUCHWALD</b> , Bejalenguas	4
<b>BÜCHS</b> , Separadores	311
<b>BUCK</b> , Martillos à percusión	3
<b>BUCK-GRAMCKO</b> , Elevadores	389
<b>BUCKLEY</b> , Ostéotomos	434
<b>BUELAU</b> , Trócares	377
<b>BUMM</b> , Curetas uterinas	654, 655
<b>BUNT</b> , Pinzas para esterilización	697
<b>BUSHE</b> , Curetas cortante	423

**C**

<b>CAPLAN</b> , Tijeras para rinología	564
<b>CASPAR</b> , Curetas cortante	425
- Separadores	304, 352, 353
- Separadores	354, 355
- Instrumentos para medir	22
- Ostéotomos	433
- Pinzas para biopsia	462, 463
<b>CASTANEDA</b> , Pinzas vasculares	182
<b>CASTROVIEJO</b> , Bléfarostatos	599
- Micro separadores	591
- Micro tijeras oculares	603
- Pinzas finas oculares	596
- Instrumentos oculares	592
- Portaagujas	238, 239, 240, 241, 242
- Instrumentos para medir	19, 20, 21
<b>CHADWICK</b> , Tijeras finas	46
<b>CHARNELY</b> , Separadores	364
<b>CHEATTLE</b> , Pinzas para esterilización	697
<b>CHILD</b> , Pinzas para tampones	8, 143
<b>CINELLI</b> , Rinología	567
<b>CITELLI</b> , Pinzas para huesos	453
<b>CLEANLACT</b> , Lubrificante para instrumentos quirúrgicos	687
<b>CLOWARD</b> , Separadores	345
- Separadores vertebrales	356
<b>CLOWARD-CONTOUR</b> , Separadores	329
<b>COAKLEY</b> , Curetas cortante	575
<b>COBB</b> , Legras	407
<b>COLIBRI</b> , Pinzas finas	594
<b>COLLIN</b> , Costótomos	475
- Separadores	346, 347, 348
- Pinzas hemostáticas	139, 143, 633
- Pinzas tira-lengua	7
- Pinzas para agrafes	271
- Pinzas para esterilización	697
- Seguetas de amputación	414
<b>COLLIN-Standard</b> , Espéculos vaginales	634
<b>CONVERSE</b> , Separadores	288
- Portaagujas	250
- Tenótomos	28
<b>COOLEY</b> , Dilatadores para valvula mitral	229
- Separadores costales	324, 366
- Pinzas vasculares	212, 213, 214, 215, 216
<b>COOPER</b> , Aguja para ligaduras	267
<b>COOK</b> , Bléfarostatos	599



<b>CORYLLOS</b> , Separadores	315
<b>COTTLE</b> , Separadores	284
- Elevadores	396
- Tijeras finas	71
- Limas para huesos	409
- Martillos quirúrgicos	430
- Ostéotomos	438, 579
- Pinzas de disección	129
- Rinología	565
- Espéculos nasales	559
- Instrumentos para magullar cartilagos	564
<b>COTTLE-MASING</b> , Tijeras finas	46
<b>COTTLE-NEIVERT</b> , Separadores	565
<b>COTTLE-WALSHAM</b> , Pinzas nasales	563
<b>COUPLAND</b> , Cánulas aspiradoras	664, 665
<b>CRAFOORD</b> , Pinzas para ligaduras	163
<b>CRILE</b> , Pinzas hemostáticas	151, 152
<b>CRILE-WOOD</b> , Portaagujas	243, 250, 252
<b>CRILE-MURRAY</b> , Portaagujas	243
<b>CUSCO</b> , Espéculos vaginales	634
<b>CUSHING</b> , Separadores	288, 289, 292
- Periostotomos	401
- Pinzas para biopsia	461
- Pinzas para huesos	469
- Pinzas finas	121, 131
- Espátulas maleable	326
<b>CUSHING-KOCHER</b> , Separadores	292

**D**

<b>DALE</b> , Pinzas vasculares	217
<b>DANDY</b> , Tijeras finas	70
- Pinzas quirúrgicas	151
- Pinzas hemostáticas	151
<b>DAUBENSPECK</b> , Curetas cortante	423
<b>DAUTREY-MUNRO</b> , Osteótomos	581
<b>DAVIDSON</b> , Separadores	316
<b>DAVIS</b> , Elevadores	382
- Pinzas para esterilización	696
<b>DAVIS-BOYLE</b> , Abre bocas	541
<b>DAY</b> , Instrumentos auriculares	551
<b>DE BAKEY</b> , Cánulas aspiradoras	664
- Dilatadores vasculares	226
- Tijeras	73
- Portaagujas	255
<b>DE BAKEY-BAHNSON</b> , Pinzas vasculares	193
<b>DE BAKEY-BAINBRIDGE</b> , Pinzas vasculares	187
<b>DE BAKEY-CAROTIS</b> , Pinzas vasculares	180
<b>DE BAKEY-MOSQUITO</b> , Pinzas vasculares	185
<b>DE BAKEY-HARKEN</b> , Pinzas vasculares	200
<b>DE BAKEY-PEAN</b> , Pinzas vasculares	186
<b>DE BAKEY (POTTS-SMITH)</b> , Tijeras	73
- Pinzas finas	126, 127, 128, 132
- Pinzas vasculares	183, 203
<b>DE BAKEY-RANKIN</b> , Pinzas vasculares	185
<b>DE BAKEY-SATINSKY</b> , Pinzas vasculares	180, 198
<b>DEAN</b> , Tijeras dentadas	70
<b>DEAVER</b> , Tijeras quirúrgicas	57
- Separadores	320, 321
<b>DEJERINE</b> , Martillos de percusión	3
<b>DEMEL</b> , Aguja para hilos	504
<b>DENIS-BROWN</b> , Separadores	362
<b>DERF</b> , Portaagujas	243, 250
<b>DERRA</b> , Pinzas vasculares	189
<b>DESCHAMPS</b> , Aguja para ligaduras	262, 263, 264, 265, 266
<b>DESJARDINS</b> , Pinzas para cálculos renales	623
- Bujías dilatadores	628
<b>DESMARRES</b> , Bisturios	28
- Separadores	287
- Pinzas finas	129
<b>DIETER</b> , Pinzas finas para huesos	554
<b>DIETRICH</b> , Tijeras	74
- Pinzas vasculares	205
- Portaagujas finas	240
<b>DIFFENBACH</b> , Pinzas Bulldog	177
<b>DIXON-LOVELACE</b> , Pinzas hemostáticas	158
<b>DINGMANN</b> , Abre bocas	542
- Pinzas para cirugía ósea	485
<b>DITTEL</b> , Bujías dilatadores	626

<b>DOCKHORN</b> , Separadores	305
<b>DOLWICK-REICH</b> , Separadores	337
<b>DOYEN</b> , Pinzas de campo	146
- Separadores	308, 363
- Pinzas traumáticas	171
- Legras	404
- Estiletes	275
- Instrumentos para fibroma	645
- Valvas vaginales	637
<b>DOYEN-COLLIN</b> , Abre bocas	6, 537
<b>DOYEN-JANSEN</b> , Abre bocas	6, 537
<b>DOYEN-STILLE</b> , Separadores	308
<b>DUBOIS</b> , Tijeras quirúrgicas	77
<b>DUKE</b> , Trócares	377
<b>DUNN-DAUTREY</b> , Separadores	546
<b>DUPLAY</b> , Espéculos	18
<b>DUPUY-WEISSE</b> , Aguja para ligaduras	262
<b>DURANTE</b> , Pinzas finas	125
<b>DUVAL</b> , Pinzas quirúrgicas	129
- Pinzas traumáticas	223
- Pinzas hemostáticas	145, 629
<b>DUVAL-COLLIN</b> , Pinzas intestinales	629

**E**

<b>ECHLIN</b> , Pinzas para huesos	470
<b>EDER</b> , Porta-algodón	279
<b>EISELBERG-MATHIEU</b> , Portaagujas	249
<b>ELLIS</b> , Instrumentos oculares	589
<b>EPKER</b> , Osteótomos	578
<b>ESMARCH</b> , Tijeras para vendajes	101

**F**

<b>FAGER</b> , Elevadores	382
<b>FAHLBUSCH</b> , Rinología	555
<b>FARABEUF</b> , Separadores	290
- Pinzas para huesos	478
- Legras	402
<b>FARABEUF-LAMBOTTE</b> , Pinzas para huesos	478
<b>FARREL</b> , Porta-algodón	277
<b>FAULKNER</b> , Pinzas finas para oftalmología	596
<b>FAURE</b> , Pinzas de campo	146
- Pinzas para biopsia	648
<b>FEICHENFELD</b> , Pinzas para espinas	134
<b>FEIN</b> , Porta-algodón	278
<b>FENO</b> , Espéculos vaginales	656
<b>FERGUSSON</b> , Cánulas aspiradoras	669
- Pinzas para presión progresiva	166
<b>FERRIS-SMITH-KERRISON</b> , Laminectomia	454, 455, 456, 457
<b>FERRIS-SMITH-CUSHING</b> , Laminectomia	458
<b>FIBULA</b> , Pinza para huesos	479
<b>FINOCCHIETTO</b> , Separadores	365
- Portaagujas	257
<b>FINSEN</b> , Separadores	327
<b>FINSTERER</b> , Cánulas aspiradoras	664
<b>FOERSTER-BALLENGER</b> , Pinzas para tampones	141
<b>FOMON</b> , Separadores	284
- Tijeras	59, 70, 71
- Limas para huesos	410, 412, 572
- Rinología	567
<b>FRANKFELDT</b> , Porta-algodón	279
<b>FRAZIER</b> , Cánulas aspiradoras	669, 674, 680
- Separadores	350
<b>FREER</b> , Elevadores	395
- Cinceles	434
- Bisturios	572
<b>FRENZEL</b> , Bejalenguas	4
<b>FRIEDMANN</b> , Pinzas para huesos	467

**G**

<b>GABON</b> , Instrumentos para huesos	586
<b>GALLAHER</b> , Limas para huesos	408
<b>GARRETT</b> , Dilatadores vasculares	227
<b>GELLHORN</b> , Pinzas para biopsia	647
<b>GELPI</b> , Separadores	328





<b>GELPI-LOKTITE</b> , Separadores	329
<b>GELPI-SEILETZ</b> , Separadores	329
<b>GEMINI</b> , Pinzas hemostáticas y ligaduras	162
<b>GENTOFT</b> , Espéculos vaginales	656
<b>GERALD</b> , Pinzas quirúrgicas	123
<b>GERALD-BROWN</b> , Pinzas quirúrgicas	123
<b>GERSTER</b> , Cirugía ósea	487
<b>GERSTER-LOWMAN</b> , Cirugía ósea	487
<b>GIDEF</b> , Pinzas hemostáticas	150
<b>GIERTZ-STILLE</b> , Costótomos	477
<b>GIGLI</b> , Seguetas de amputación	414
<b>GIL-VERNET</b> , Separadores	293
<b>GILLIES</b> , Separadores	283
- Portaagujas	247, 253
<b>GLASSMAN</b> , Tijeras quirúrgicas	52
<b>GLOVER</b> , Pinzas Bulldog	179, 180
- Pinzas vasculares	207
<b>GOLDMAN-FOX</b> , Tijeras quirúrgicas	49, 50, 80, 84
<b>GOELET</b> , Separadores	291
<b>GORNEY</b> , Tijeras quirúrgicas	68
- Cánulas aspiradoras	667
<b>GOSSET</b> , Separadores abdominales	357
<b>GOURDET</b> , Curetas uterinas	651
<b>GRAEFE</b> , Bisturios	46
- Pinzas finas	114, 129
- Instrumentos oculares	589, 590
- Micro bisturios	27, 590
<b>GRAY</b> , Pinzas para ligaduras	164
<b>GRAVE</b> , Espéculos vaginales	634
<b>GREGORY</b> , Pinzas vasculares	207
<b>GREENE</b> , Separadores	311
<b>GROSS</b> , Pinzas hemostáticas	139, 141
<b>GRUENWALD</b> , Pinzas quirúrgicas	133
<b>GUILLIEN</b> , Cánula aspiradora	667
<b>GUSBERG</b> , Curetas para biopsia endocervical	646
<b>GUTHRIE</b> , Separadores	283
<b>GUYON</b> , Bujías dilatadoras	628
- Catéteres	624
- Pinzas para pedúnculos renales	175
- Pinzas uterinas	629

**H**

<b>HABERER</b> , Espátulas maleable	326
<b>HAGLUND</b> , Pinzas para arrancar vendajes	533
<b>HALLE</b> , Curetas cortante	422
<b>HALSEY</b> , Portaagujas	243, 250
<b>HALSTED</b> , Pinzas hemostáticas	150, 152
<b>HALSTED-MOSQUITO</b> , Pinzas hemostáticas	149, 152
<b>HANK</b> , Dilatadores uterinos	641
<b>HARRINGTON</b> , Separadores	317
<b>HARTMANN</b> , Bejalenguas	544
- Cánulas aspiradoras	676, 677
- Diapasones	5
- Porta-algodón	278
- Pinza para huesos	469
- Pinzas auriculares	552, 553
- Espéculos nasales	18, 560, 561
<b>HARTMANN-BABY-MOSQUITO</b> , Pinzas hemostáticas	149
<b>HAYES</b> , Pinzas traumáticas	218
<b>HEANEY</b> , Portaagujas	257
<b>HEANEY-HEGAR</b> , Portaagujas	244
<b>HEAT</b> , Martillos quirúrgicos	431
<b>HEGAR</b> , Dilatadores uterinos	639, 641
- Portaagujas	244, 251
<b>HEGAR-MAYO-SEELEY</b> , Portaagujas	245, 252
<b>HEGENBARTH</b> , Pinzas quirúrgicas	271
<b>HEILDELBERG</b> , Porta-algodón	278
<b>HEISS</b> , Pinzas hemostáticas	158
<b>HEISTER</b> , Abre bocas	6, 537
<b>HEMINGWAY</b> , Curetas cortante	415
<b>HENAHAN</b> , Periostotomos	401
<b>HENLEY</b> , Separadores	344
<b>HENNIG</b> , Pinza para arrancar vendajes	533
<b>HEPARIN</b> , Cánulas aspiradoras maleable	682
<b>HEYMANN</b> , Tijeras	71
<b>HEYMANN-KNIGHT</b> , Tijeras	71
<b>HIBBS</b> , Separadores	297
- Osteótomos	439

<b>HOHMANN</b> , Elevadores	391, 394
<b>HOLZBACH</b> , Separadores	349
<b>HÖPFNER</b> , Pinzas intestinales	174
<b>HOPT</b> , Pinzas vasculares	219
<b>HOUSE</b> , Cánulas aspiradoras	672
<b>HOWARD</b> , Limas para huesos	408, 570
<b>HOWARTH</b> , Periostotomos	397
<b>HUNTER</b> , Pinzas para espinas	134
<b>HURD</b> , Periostotomos	397

**I**

<b>INGE</b> , Separadores vertebrales	356
<b>IRIS</b> , Tijeras finas	44, 81, 83, 84, 99
<b>ISRAEL</b> , Separadores	298
<b>ITARD</b> , Cánulas aspiradoras	677

**J**

<b>JACKSON-TESSIER</b> , Tijeras para huesos	476
<b>JACOBSON</b> , Curetas cortante	416
- Micro tijeras	40
- Perforadores para huesos	501, 502, 503, 527
- Portaagujas	235, 241
<b>JACOBSON-UNIVERSAL</b> , Perforadores para huesos	527
<b>JAMESON</b> , Tijeras finas	47
<b>JAMESON-WERBER</b> , Tijeras finas	47
<b>JANSEN</b> , Curetas cortante	416
- Separadores	327
- Pinzas para huesos	469
- Pinzas finas	133
- Legras	402
<b>JANSEN-LEUER</b> , Pinzas para huesos	468
<b>JAVID</b> , Pinzas vasculares	222
<b>JONES</b> , Pinzas de campo	146
- Pinzas hemostáticas	139
<b>JOSEPH</b> , Separadores	284
- Limas para huesos	408
- Limas nasales	573, 574
- Periostotomos	401
- Tijeras	58
<b>JUDD-MASSON</b> , Separadores vesicales	369

**K**

<b>KALLMORGEN</b> , Valvas vaginales	635
<b>KELLY</b> , Separadores	310
- Tijeras quirúrgicas	53, 85
- Pinzas hemostáticas	155
<b>KERN</b> , Pinzas para Cirugía ósea	486
<b>KERPEL</b> , Curetas cortante	418
<b>KERSHNER</b> , Separadores para oftalmología	598
<b>KERRISON</b> , Laminectomia	453
<b>KERRISON-JACOBY</b> , Laminectomia	455
<b>KEVORKIAN</b> , Pinzas para biopsia	650
<b>KEY-HORSLEY</b> , Pinzas para huesos	475
<b>KEYES</b> , Trépanos cutáneos	28, 491
<b>KILLIAN</b> , Cánulas aspiradoras	678
- Tijeras nasales	72
- Tijeras para rinología	564
- Cinceles	565
- Espéculos nasales	560, 561
<b>KILLIAN-KLAUS</b> , Osteotomos	565
<b>KILNER</b> , Tijeras	47, 52, 85
- Portaagujas	256
<b>KILNER-DOUGHTY</b> , Abre bocas	540
<b>KIMURA</b> , Micro espátulas	592
<b>KIRSCH</b> , Separadores	304
<b>KIRSCHNER</b> , Separadores	361
<b>KLIMA-ROSEGGER</b> , Agujas para biopsia	377
<b>KOCHER</b> , Agujas para ligaduras	267
- Separadores	292, 294, 296, 301, 305, 307
- Pinzas hemostáticas	153, 155, 157
- Pinzas intestinales	172, 173
- Estiletes conductores	269
<b>KOCHER-LAGENBECK</b> , Separadores	300
<b>KOCHER-OCHSNER</b> , Pinzas quirúrgicas	154



<b>KOENIG</b> , Estiletes conductores	269
<b>KOERTE</b> , Separadores	323
<b>KÖNIG</b> , Elevadores	381
<b>KRAUSE</b> , Rinología	562
- Trócartes	375
<b>KRESSNER</b> , Pinzas nasales	563
<b>KRISTELLER</b> , Espéculos vaginales	636
<b>KROENIG</b> , Bejalengua	4
<b>KRONECKER</b> , Agujas para ligaduras	262
<b>KÜHNE</b> , Pinzas depilatorie	135
<b>KÜNTSCHER</b> , Agujas	496
- Cirugía ósea	500

**L**

<b>LA FORCE</b> , Micro bisturios	589
<b>LA GRANGE</b> , Tijeras quirúrgicas	50, 80
<b>LAHEY</b> , Separadores	288
<b>LAMBERT-KAY</b> , Pinzas vasculares	210
<b>LAMBOTTE</b> , Osteotomos	437
- Pinza para huesos	478
- Legras	404
<b>LANDAU</b> , Valvas vaginales	637
<b>LANDOLT</b> , Mango de bisturios	34
- Pinzas para biopsia	465
<b>LANE</b> , Destornilladores	528
- Pinzas para huesos	486
<b>LANGE</b> , Separadores	289
<b>LANGENBECK</b> , Portaagujas	259
- Separadores	299
- Elevadores	395
- Legras	402
- Seguetas de amputación	414
<b>LANGENBECK-RYDER</b> , Portaagujas	259
<b>LAWRENCE</b> , Pinzas hemostáticas y para ligaduras	165
<b>LEES</b> , Pinzas vasculares	209
<b>LEKSELL</b> , Pinzas para huesos	470
<b>LELAND-JONES</b> , Pinzas vasculares	215
<b>LEMPERT</b> , Pinzas para huesos	468
<b>LERICHE</b> , Pinzas hemostáticas	151
<b>LEWIN</b> , Pinzas para huesos	479
<b>LEWIS</b> , Limas para huesos	409
- Limas nasales	573
<b>LEXER</b> , Tijeras quirúrgicas	66, 95
- Osteotomos	446, 448
- Cinceles	445, 446
<b>LEVIS</b> , Fonendoscopio	10
<b>LICHTENBERG</b> , Portaagujas	261
<b>LICHTWITZ</b> , Trócartes	375
<b>LIEBERMANN-TENNANT</b> , Separador párpados	598
<b>LINDEMANN</b> , Seguetas para aamputación	414
<b>LISTER</b> , Tijeras para vendajes	101
- Pinzas hemostáticas	139
<b>LISTER-BURCH</b> , Bléfarostatos	599
<b>LISTON</b> , Pinzas para huesos	473
<b>LISTON-STILLE</b> , Pinzas para huesos	475
<b>LITTAUER</b> , Pinzas auriculares	552
- Pinzas depilatorie	135
<b>LITTLER</b> , Tijeras finas	59
<b>LITTLEWOOD</b> , Pinzas uterinas	644
<b>LOCHART</b> , Estiletes	275
<b>LOCKLIN</b> , Tijeras finas	48, 53
<b>LÖFFEL</b> , Pinzas para rinología	558
<b>LOGAN</b> , Separadores	327
<b>LORENZ</b> , Tijeras para vendajes	101
<b>LORNA</b> , Pinzas de campo	147
<b>LOUTE</b> , Cirugía ósea	499
<b>LOVE</b> , Separadores	289
<b>LOVE-GRUENWALD</b> , Pinzas para biopsia	460, 461
<b>LUCAE</b> , Diapasones	5
- Martillos quirúrgicos	429
- Pinzas quirúrgicas	133
- Instrumentos auriculares	551
<b>LUER</b> , Pinzas para huesos	
<b>LUER-KÖRTE</b> , Curetas uterinas	651
<b>LUER-LOCK</b> , Mangos porta-cánules	681
<b>LUER-STILLE</b> , Pinza para huesos	469, 471, 472

**M**

<b>MAGILL</b> , Cánules aspiradoras	678
- Pinzas para introducir catéteres	7
<b>MAIER</b> , Pinzas para tampones	142, 633
<b>MALTZ</b> , Limas nasales	574
<b>MARKHAM-MEYERDING</b> , Separadores	336
<b>MARTIN</b> , Separadores	314
- Pinza para huesos	485
- Porta-algodón	277
- Histerómetros	642
<b>MARTINI</b> , Curetas cortante	416
<b>MASING</b> , Elevadores	396
<b>MASSON</b> , Portaagujas	245, 257
<b>MATHIEU</b> , Separadores	290
- Separador rectale	369
- Portaagujas	248, 249, 260
- Valvas vaginales	635
<b>MAYO</b> , Tijeras quirúrgicas	64, 65, 82, 96
- Histerómetros maleable	642
- Espatulas	4
- Pinzas para esterilización	697
<b>MAYO-HARRINGTON</b> , Tijeras	75
<b>MAYO-HEGAR</b> , Portaagujas	244, 251, 252
<b>MAYO-HEGAR-HEANEY</b> , Portaagujas	256
<b>MAYO-LEXER</b> , Tijeras quirúrgicas	96
<b>MAYO-NOBLE</b> , Tijeras quirúrgicas	64
<b>MAYO-RUSSIAN</b> , Pinzas finas	125
<b>MAYO-STILLE</b> , Tijeras	67, 94
<b>MC DONALD</b> , Elevadores	397
<b>MC INTOSH</b> , Laringoscopios	11, 14, 16
<b>MC IVOR</b> , Abrebocas	541
<b>MC KENTY</b> , Elevadores	397
<b>MC KESSON</b> , Cánules aspiradoras	660
<b>MC PHERSON</b> , Pinzas finas	595, 596
<b>MEAD</b> , Elevadores	395
- Martillos quirúrgicos	429
- Pinzas para huesos	467
<b>MEEKER</b> , Pinzas hemostáticas y ligaduras	165
<b>MELLINGER</b> , Bléfarostatos	599
<b>METZENBAUM</b> , Tijeras	59, 60, 61, 81, 84, 89, 90, 91, 92, 99
<b>MEYERDING</b> , Separadores	312, 335
<b>MICHEL</b> , Pinzas para agrafes	271
<b>MICRO-HALSTEAD</b> , Pinzas hemostáticas	149
<b>MICRO-HARTMANN</b> , Pinzas auriculares	552
<b>MICRO-IRIS</b> , Tijeras finas	44
<b>MICRO-RYDER</b> , Portaagujas	258
<b>MICRO-VASCULAR</b> , Portaagujas	255
<b>MIDDLELDORPF</b> , Separadores	306
<b>MIKULICZ</b> , Separadores	322, 323
- Pinzas hemostáticas	158
<b>MILLER</b> , Laringoscopios	12, 15, 16
- Limas para huesos	408, 570
<b>MILLIGAN</b> , Elevadores	382
<b>MILLIN</b> , Separadores vesicales	369
<b>MINI-FRIEDMANN</b> , Pinzas para huesos	466, 467
<b>MINI-GILLIES</b> , Portaagujas con tijeras	247, 253
<b>MINI-HOHMANN</b> , Elevadores	389
<b>MINI-LAMBOTTE</b> , Osteotomos	437, 438
<b>MINI-LEXER</b> , Osteotomos	440, 445
<b>MINI-OLSEN-HEGAR</b> , Portaagujas con tijeras	246
<b>MINI-ROUX</b> , Separadores	291
<b>MINNESOTA</b> , Separadores	539
<b>MISKIMON</b> , Separadores	340
<b>MIXTER</b> , Pinzas hemostáticas	162, 164
<b>MOLLISON</b> , Separadores	335
<b>MOLT</b> , Abrebocas para niños	537
- Periostotomos	401
<b>MORRIS-DE BAKEY</b> , Pinzas vasculares	195
<b>MORSE</b> , Separadores costales	367
<b>MÜNCHEN</b> , Curetas para biopsia	646
<b>MUSEUX</b> , Pinzas uterinas	644

**N**

<b>NEGUS</b> , Pinza hemostáticas y ligaduras	165
<b>NEGUS-GUEDEL</b> , Laringoscopios	13, 16
<b>NELATON</b> , Estiletes	275



<b>NELSON</b> , Tròcart	374
<b>NELSON-METZENBAUM</b> , Tijeras quirùrgicas	62, 93
<b>NEUBÛSER</b> , Pinzas para tube	645
<b>NEUMANN</b> , Tijeras	50
<b>NICOLA</b> , Rinologìa	555
<b>NOVAK</b> , Curetas aspiradoras	646
<b>NOYES</b> , Micro tijeras	39, 601
<b>NUBOER</b> , Cànules aspiradores	666

**O**

<b>OBWEGESER</b> , Agujas para ligaduras	489
- Separadores	302, 303, 545
- Osteòtomos	437, 449, 450, 568
- Periostòtomos	398, 399, 400
<b>OCHSNER</b> , Pinzas vasculares	205
- Tròcart	374
<b>OLDBERG</b> , Pinzas para biopsia	465
<b>OLIVECRONA</b> , Disecadores	383
- Pinzas para huesos	469
- Espatulas maleable	326
<b>OLLIER</b> , Separadores	297
<b>OLSEN-HEGAR</b> , Portaagujas con tijeras	246, 253
<b>OMBREDANNE</b> , Martillos quirùrgicos	431
<b>ORINGER</b> , Abrebocas	538
<b>OSHIKA-FAULKNER</b> , Pinzas finas	596
<b>OVERHOLT</b> , Pinzas para ligaduras	161
<b>OVERHOLT-GEISENDORFER</b> , Pinzas para ligaduras	161

**P**

<b>PAPAVERO-CASPAR</b> , Especulum nasales	559
<b>PAPAVERO-HARTMANN</b> , Especulum nasales	559
<b>PARAMETRIUM</b> , Tijeras quirùrgicas	97
<b>PARKER-LANGENBECK</b> , Separadores	290
<b>PARTSCH</b> , Osteotomos	435, 436
<b>PATELLA</b> , Pinzas para huesos	481
<b>PAYR</b> , Pinzas intestinales	174
- Estiletos conductores	269
<b>PEAN</b> , Pinzas hemostáticas	150, 153, 156
<b>PEAN-MURPHY</b> , Pinzas hemostáticas	140
<b>PECK-JOSEPH</b> , Tijeras quirùrgicas	84
<b>PEDERSON</b> , Espéculos vaginales	634
<b>PELTON-CRANE</b> , Cànules aspiradoras	679
<b>PENFIELD</b> , Disecadores	385
<b>PERRY</b> , Pinzas quirùrgicas	115
<b>PERTHES</b> , Perforadores para huesos	490
<b>PHILIPS</b> , Destornilladores	528
<b>PIERCE</b> , Tròcart	375
<b>PIERSE</b> , Pinzas finas	594
<b>PLESTER</b> , Cànules aspiradoras	669
- Separadores	333, 334
<b>POOLE</b> , Cànules aspiradoras	675
<b>POTTS</b> , Pinzas vasculares	206, 208
<b>POTTS-SMITH</b> , Tijeras vasculares	73
- Pinzas quirùrgicas	120, 131
<b>POTTS-YASARGIL</b> , Micro Tijeras	40
<b>POZZI</b> , Pinzas uterinas	643
<b>PRATT</b> , Dilatadores uterinos	640
<b>PRICE-THOMAS</b> , Pinzas vasculares	224
<b>PROST</b> , Bléfarostatos	599
<b>PUTTI</b> , Limas para huesos	413

**Q**

<b>QUINBY</b> , Tijeras	46
<b>QUINKE</b> , Agujas para biopsia	378, 684

**R**

<b>RADOLF</b> , Pinza para arrancar uñas	488
<b>RAGNEL-DAVIS</b> , Separadores	288
<b>RAMPLEY</b> , Pinzas para tampones	142, 633
<b>RAMUS</b> , Pinzas para huesos	548
<b>RANDALL</b> , Curetas aspiradoras	646
- Pinzas para cálculos renales	623

<b>RANKIN</b> , Pinzas hemostáticas	155
<b>RECAMIER</b> , Curetas uterinas	653
<b>REDON</b> , Agujas	270
<b>REILL</b> , Micro portaagujas	610
- Pinzas para huesos	480
<b>REVERDIN</b> , Espatulas	326
<b>REYNOLDS</b> , Tijeras quirùrgicas	51
<b>RICARD</b> , Separadores	349
<b>RICHARDSON</b> , Separadores	309
<b>RICHARDSON-EASTMAN</b> , Separadores	309
<b>ROBB</b> , Elevadores	384
<b>ROBIN</b> , Pinzas de campo	147
<b>ROCHARD</b> , Separadores	363
<b>ROCHESTER-CARMALT</b> , Pinzas hemostáticas	171
<b>ROCHESTER-PEAN</b> , Pinzas hemostáticas	154, 162
<b>RODHOIL</b> , Lubrificante para instrumentos	687
<b>ROGGE</b> , Pinzas para esterilizaciòn	696
<b>ROSEN</b> , Agujas-Cànules aspiradoras	681
<b>ROSER-KONIG</b> , Abrebocas	6, 537
<b>ROSS</b> , Separadores	319
<b>ROTAN</b> , Cànules aspiradores	671
<b>RÖTTGEN-RUSKIN</b> , Pinza para huesos	471
<b>ROUX</b> , Separadores	291
<b>ROUX-MAGNUS</b> , Separadores	291
<b>ROWE</b> , Pinzas para huesos	550
<b>RUBIN</b> , Pinzas nasales	563
<b>RUMEL</b> , Pinzas hemostáticas y ligaduras	163
<b>RUSKIN-STILLE</b> , Pinzas para huesos	470
<b>RUSKIN-LISTON</b> , Pinzas para huesos	474
<b>RUSSIAN</b> , Pinzas quirùrgicas	125
<b>RYDER</b> , Portaagujas	258
<b>RYDEL-SEIFER</b> , Diapasones	5

**S**

<b>SACHS</b> , Elevadores	382
<b>SALZBURG</b> , Elevadores	396
<b>SANDERS-BROWN</b> , Agujas para ligaduras	489
<b>SANTULLI</b> , Pinzas Bulldog	180
<b>SAROT</b> , Portaagujas	254
<b>SATINSKY</b> , Tijeras	69
- Pinzas vasculares	225
<b>SAUERBRUCH</b> , Costotomos	477
- Separadores	301, 315
- Pinzas para huesos	472
- Pinzas para esterilizaciòn	697
<b>SAUERBRUCH-FREY</b> , Costotomos	477
<b>SAUG-RASPATORIUM</b> , Cànules aspiradoras	667
<b>SCHAEDEL</b> , Pinzas de campo	146
<b>SCHUDE</b> , Curetas cortante	419
<b>SCHLESINGER</b> , Laminectomìa	456
<b>SCHMID</b> , Agujas vasculares maleable	228, 681
<b>SCHMIEDEN</b> , Agujas para ligaduras	267
<b>SCHMIEDEN-DICK</b> , Agujas para ligaduras	267
<b>SCHMIEDEN-TAYLOR</b> , Tijeras quirùrgicas	70
<b>SCHNEIDER</b> , Legras	402
<b>SCHRÖDER</b> , Curetas cortante	424
- Pinzas uterinas	643
<b>SCHUBERT</b> , Pinzas para biopsia	649
<b>SCHUMACHER</b> , Elevadores	392
- Costotomos	477
- Pinzas para biopsia	650
<b>SCOVILLE</b> , Separadores	292, 350, 351
<b>SCOVILLE-HAVERFIELD</b> , Separadores	350
<b>SEDILLOT</b> , Periostotomos	397
- Legras	402
<b>SELDIN</b> , Elevadores	395
<b>SELMAN</b> , Pinzas hemostáticas	125
<b>SEMB</b> , Separadores	403
<b>SEMKEN</b> , Pinzas quirùrgicas	115, 120, 130
<b>SENN-GREEN</b> , Separadores	287
<b>SENN-MILLER</b> , Separadores	288
<b>SEPTUN-NADEL</b> , Agujas-Cànules	680
<b>SHAPLEIGH</b> , Curetas auriculares	551
<b>SIEBENMANN</b> , Cànules aspiradoras	677
<b>SIEBOLD</b> , Tijeras quirùrgicas	78
<b>SIGMOID-NOTCH</b> , Periostotomos-Separadores	388, 547
<b>SILVER</b> , Cinceles	566
<b>SIMON</b> , Curetes cortante	424



- Separadores	314
<b>SIMPSON</b> , Histerómetros	642
<b>SIMPSON-BRAUN</b> , Pinzas para el útero y obstétricos	656
<b>SIMS</b> , Tijeras quirúrgicas	75, 76, 98
- Histerómetros	642
<b>SINGLEY-TUTTLE</b> , Pinzas de disección	125
<b>SMITH</b> , Tijeras para cortar alambre	102
<b>SMITH-BUIE</b> , Separadores	370
<b>SMITH-PETERSEN</b> , Osteotomos	442
<b>SNELLEN</b> , Instrumentos oculares	591
<b>SPENCER</b> , Tijeras para ligaduras	100
<b>SPLIT</b> , Osteotomos curvos	578
<b>SPURLING</b> , Pinzas para biopsia	461
<b>STACKE</b> , Estiletes	276
<b>STAMMBERGER</b> , Pinzas para rinología	556
<b>STEINHÄUSER</b> , Periotótomos	400
<b>STEINMANN</b> , Agujas	496, 497
<b>STELLBRINK</b> , Pinzas para huesos	466
<b>STERNBERG</b> , Separadores	290, 539
<b>STEVENS</b> , Tijeras finas	51
- Portaagujas	242
<b>STIEGLITZ</b> , Pinzas para espinas	134
<b>STILLE</b> , Tijeras quirúrgicas	67
- Osteotomos	441
- Pinza para huesos	471
- Pinzas quirúrgicas	118
- Pinza para arrancar vendajes	533
- Pinzas renales	175
- Portaagujas	249
- Pinzas uterinas	629
- Cinceles	441
<b>STILLE-BARRAYA</b> , Pinzas quirúrgicas	124
<b>STRULLY</b> , Tijeras quirúrgicas	69
<b>STRUYCKEN</b> , Pinzas para rinología	556
<b>SUBRAMANIAN</b> , Pinzas vasculares	221
<b>SUBRAMANIAN-MINIATURE</b> , Pinzas vasculares	221
<b>SWEDESH mod.</b> , Portaagujas	254
<b>SYPERT</b> , Osteotomos	433
- Pinzas para biopsia	464

**T**

<b>TAKAHASHI</b> , Pinzas para biopsia	460
<b>TAYLOR</b> , Separadores	351
- Elevadores	394
- Martillos de percusión	3
- Pinzas quirúrgicas	131
<b>TERRIER</b> , Pinzas hemostáticas	139
<b>TESSIER</b> , Curetas cortante	425
- Separadores	313, 545
- Osteotomos	443, 583
- Pinzas para huesos	585
- Pinzas para huesos	549
<b>THOMS-GAYLOR</b> , Pinzas para biopsia	647
<b>TISCHLER-MORGAN</b> , Pinzas para biopsia	650
<b>TOBOLD</b> , Bejalenguas	544
<b>TÖNNIS</b> , Tijeras quirúrgicas	63
- Portaagujas	247, 259
<b>TÖNNIS-ADSON</b> , Tijeras quirúrgicas	63, 97
<b>TÖNNIS-RYDER</b> , Portaagujas	259
<b>TROELTSCH</b> , Pinzas de disección	133
<b>TROEMNER</b> , Martillos de percusión	3
<b>TROUTMAN</b> , Pinzas finas para oftalmología	596
- Micro tijeras para oftalmología	603
<b>TUBBS</b> , Dilatadores	229
<b>TUFFIER</b> , Separadores costales	367
- Espátulas maleable	326
<b>TUOHY</b> , Agujas para biopsia	378, 684

**U**

<b>UFFENORDE</b> , Curetas cortante	418
<b>ULRICH</b> , Pinzas para huesos	484
<b>UNIVERSAL</b> , Porta-algodón	277
- Trócares	376
<b>URO-TANGENTIAL</b> , Pinzas vasculares	220

**V**

<b>VALLEIX</b> , Histerómetros	642
<b>VAN DOREN</b> , Pinzas para biopsia	648
<b>VANNAS</b> , Micro Tijeras	39, 43, 600
<b>VARADAY</b> , Instrumentos para vârices	228
<b>VERBRUGGE</b> , Pinzas para huesos	482
<b>VERRES</b> , Agujas para biopsia	684
<b>WISE</b> , Pinzas finas	107
<b>VOLKMANN</b> , Curetas cortante	417, 420
- Separadores	294, 295
<b>VOLLMAR</b> , Sonda para vârices	228

**W**

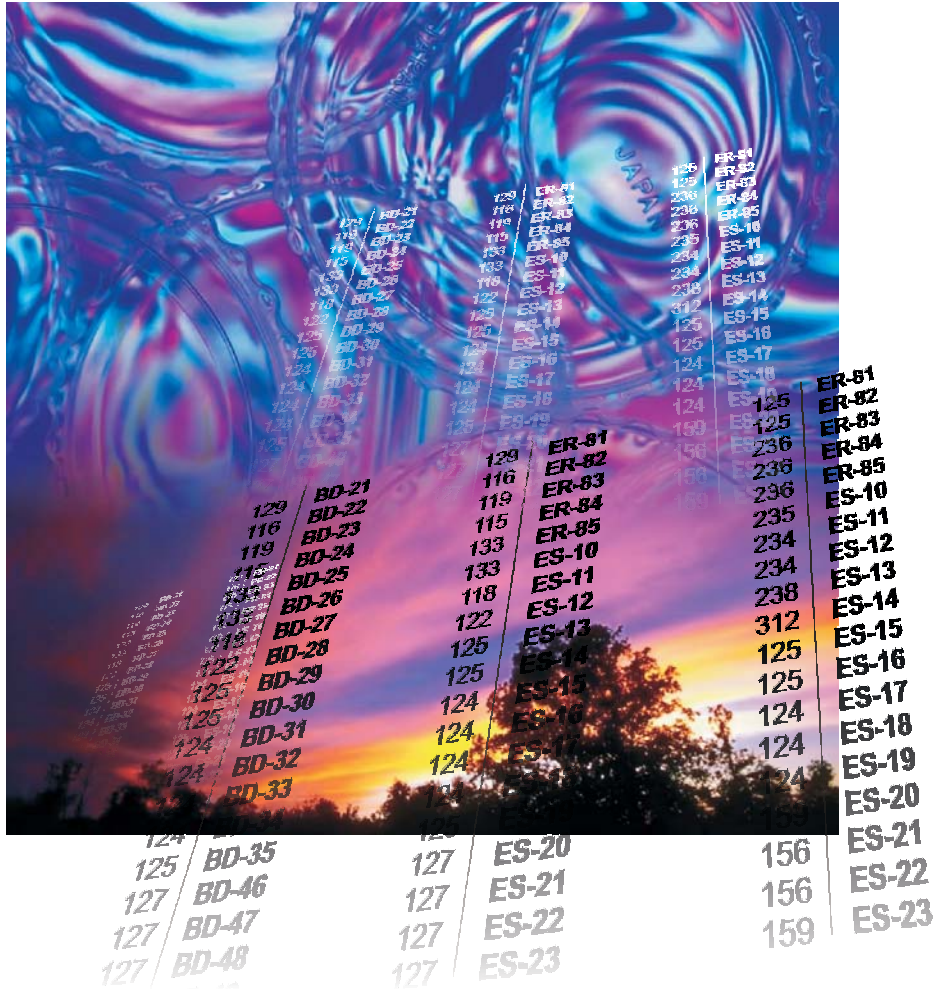
<b>WAGNER</b> , Cirugia ósea	500
- Pinzas para biopsia	464
<b>WALDMANN</b> , Tijeras para episiotomia	79
<b>WALLICH</b> , Curetas uterinas	652
<b>WALTON</b> , Separadores	336
<b>WALTON-POOLE</b> , Cánulas aspiradoras	675
<b>WANGENSTEIN</b> , Pinzas quirúrgicas	131
- Portaagujas	245, 252
<b>WASSMUND</b> , Separadores	299
<b>WEBER</b> , Anses oculares	591
- Pinzas vasculares	204
<b>WEBSTER</b> , Portaagujas	250
<b>WECKER</b> , Micro estaulas	590
- Micro tijeras	600
<b>WEIL-BLAKESLEY</b> , Pinzas para biopsia	459
<b>WEITLANER</b> , Separadores	330, 331, 332, 338
<b>WELLER</b> , Tijeras quirúrgicas	78
<b>WERTHEIM</b> , Tijeras quirúrgicas	58, 98
- Pinzas renales	176, 630, 631
- Portaagujas	256
<b>WEST</b> , Elevadores	395
<b>WESTCOTT</b> , Micro Tijeras	39, 601
<b>WHERTEIMER</b> , Cánulas aspiradoras	674
<b>WHITEHEAD-JENNINGS</b> , Abrebocas	6, 540
<b>WIEDER</b> , Bejalenguas	544
<b>WIKSTROEM</b> , Pinzas para ligaduras	164
<b>WILDE</b> , Polipótomos	562
<b>WILDER</b> , Dilatador ocular	592
<b>WILLIAMS</b> , Bléfarostatos	599
<b>WILLIGER</b> , Curetas cortante	416, 422
- Elevadores	381
- Martillos quirúrgicos	429
<b>WINTER</b> , Pinzas para aborte	632
<b>WOLFF</b> , Pinzas para arrancar vendajes	532
<b>WULLSTEIN</b> , Cánulas aspiradoras	665
- Separadores	330
- Micro Curetas	554

**Y**

<b>YANKAUER</b> , Cánulas aspiradoras	662
<b>YASARGIL</b> , Cánulas aspiradoras	668
- Micro tijeras	40, 43
- Pinzas para biopsia	465
- Pinzas finas	110
- Portaagujas	236, 237
<b>YASARGIL-NICOLA</b> , Pinzas finas para rinología	555
<b>YOUNG</b> , Pinzas tira-lengua	8, 143

**Z**

<b>ZAUFAL-JANSEN</b> , Pinzas para huesos	470
<b>ZIEGLER</b> , Micro bisturios	27, 589
<b>ZIELINSKY</b> , Instrumentos para medir	22
<b>ZIELKE</b> , Osteotomos	448







Articolo	Pagina	Articolo	Pagina	Articolo	Pagina	Articolo	Pagina
AA-70	17	AB-55	10	BD-67	118	BD-144	119
AA-80	17			BD-68	112	BD-145	115
AA-90H	17	AC-11	5	BD-70	116	BD-146	133
AA-100	11	AC-12	5	BD-71	116	BD-147	133
AA-101	11	AC-13	5	BD-72	116	BD-148	118
AA-102	11	AC-14	5	BD-73	116	BD-149	122
AA-103	11	AC-15	5	BD-74	117	BD-151	125
AA-104	11	AC-16	5	BD-75	117	BD-152	125
AA-130	17	AC-20	5	BD-76	117	BD-153	124
AA-151	17	AC-30	5	BD-78	117	BD-154	124
AA-153	17	AC-40	5	BD-79	117	BD-155	124
AA-200	12			BD-80	127	BD-156	124
AA-201	12	BB-38	34	BD-81	127	BD-157	125
AA-202	12	BB-40	34	BD-82	127	BD-160	127
AA-203	12	BB-46	34	BD-83	127	BD-161	127
AA-204	12	BB-48	34	BD-84	127	BD-162	127
AA-250	15	BB-50	34	BD-85	127	BD-163	127
AA-251	15	BB-52	34	BD-86	127	BD-164	127
AA-252	15			BD-87	127	BD-165	128
AA-253	15	BD-04	114	BD-88	127	BD-166	128
AA-254	15	BD-05	115	BD-89	127	BD-167	128
AA-401	13	BD-06	115	BD-90	116	BD-168	128
AA-402	13	BD-07	114	BD-91	120	BD-169	128
AA-403	13	BD-09	121	BD-92	116	BD-170	128
AA-404	13	BD-10	117	BD-93	116	BD-171	128
AA-500	14	BD-14	120	BD-94	125	BD-172	128
AA-501	14	BD-15	120	BD-95	120	BD-173	128
AA-502	14	BD-16	118	BD-96	114	BD-174	134
AA-503	14	BD-17	124	BD-97	117	BD-175	125
AA-504	14	BD-18	121	BD-98	117	BD-176	125
AA-B100	11, 17	BD-19	121	BD-99	117	BD-179	133
AA-B101	11, 17	BD-20	121	BD-100	117	BD-180	121
AA-S103	16	BD-21	120	BD-101	133	BD-181	121
AA-S104	16	BD-22	133	BD-102	133	BD-182	121
AA-S105	16	BD-23	117	BD-104	121	BD-183	121
AA-S203	16	BD-24	117	BD-105	117	BD-184	124
AA-S204	16	BD-25	117	BD-106	122	BD-185	124
AA-S205	16	BD-26	117	BD-107	122	BD-186	126
AA-S253	16	BD-27	125	BD-108	122	BD-190	126
AA-S254	16	BD-28	124	BD-109	119	BD-191	126
AA-S255	16	BD-29	125	BD-110	119	BD-192	126
AA-S403	16	BD-30	116	BD-111	119	BD-193	133
AA-S404	16	BD-31	116	BD-112	119	BD-194	114
AA-S503	16	BD-32	113	BD-113	119	BD-195	114
AA-S504	16	BD-33	113	BD-114	119	BD-196	114
AA-S505	16	BD-34	113	BD-115	122	BD-198	129
AA-T60	17	BD-35	113	BD-116	122	BD-199	129
		BD-36	113	BD-117	122	BD-200	112
AB-04	18	BD-37	125	BD-118	122	BD-201	112
AB-05	18	BD-38	121	BD-119	122	BD-202	112
AB-06	18	BD-39	121	BD-120	134	BD-203	112
AB-07	18	BD-40	113	BD-121	134	BD-204	618
AB-09	18	BD-41	113	BD-122	134	BD-205	112
AB-10	3	BD-42	113	BD-123	134	BD-206	112
AB-11	3	BD-43	113	BD-124	117	BD-210	130
AB-12	3	BD-44	115	BD-126	117	BD-211	130
AB-14	3	BD-45	115	BD-127	119	BD-212	130
AB-16	3	BD-46	115	BD-128	121	BD-213	130
AB-18	3	BD-47	115	BD-129	121	BD-214	130
AB-32	18	BD-50	134	BD-130	129	BD-215	130
AB-32R	18	BD-52	271	BD-131	129	BD-216	130
AB-34	18	BD-53	120	BD-132	129	BD-217	130
AB-38	18	BD-54	120	BD-133	121	BD-218	131
AB-40	18	BD-60	112	BD-134	121	BD-219	131
AB-41	18	BD-61	118	BD-135	129	BD-220	131
AB-41R	18	BD-62	112	BD-136	129	BD-221	132
AB-50	10	BD-63	118	BD-138	122	BD-222	132
AB-51	10	BD-64	112	BD-139	122	BD-223	132
AB-52	10	BD-65	118	BD-140	129	BD-224	132
AB-54	10	BD-66	112	BD-141	116	BD-225	132



Articolo	Pagina	Articolo	Pagina	Articolo	Pagina	Articolo	Pagina
BD-226	131	BF-26	140	BM-17	267	BM-117	270
BD-227	131	BF-27	140	BM-18	267	BM-122	270
BD-228	131	BF-28	140	BM-19	262	BM-123	270
BD-229	132	BF-29	140	BM-20	262	BM-124	270
BD-230	130	BF-30	142, 633	BM-21	263	BM-125	270
BD-231	130	BF-31	142, 633	BM-22	263	BM-126	270
BD-232	131	BF-32	632	BM-23	263	BM-127	270
BD-233	131	BF-33	632	BM-24	263	BM-132	270
BD-234	131	BF-34	632	BM-25	269	BM-133	270
BD-235	107, 618	BF-35	632	BM-26	269	BM-134	270
BD-236	107	BF-36	146	BM-27	177	BM-135	270
BD-237	107	BF-38	146	BM-28	268	BM-136	270
BD-238	115	BF-40	146	BM-29	267	BM-137	270
BD-239	115	BF-41	146	BM-30	177		
BD-240	118	BF-42	146, 620	BM-31	177	BPS-10	693
BD-241	118	BF-43	146	BM-32	177	BPS-12	693
BD-242	118	BF-44	146	BM-33	177	BPS-14	693
BD-243	118	BF-45	146	BM-34	177	BPS-15	693
BD-244	118	BF-46	146	BM-35	177	BPS-17	693
BD-245	118	BF-48	146	BM-36	177		
BD-246	118	BF-49	643	BM-37	177	BR-20	693
BD-247	118	BF-50	147	BM-38	177	BR-25	693
BD-248	118	BF-51	644	BM-39	177	BR-28	693
BD-249	118	BF-52	147	BM-40	269		
BD-250	130	BF-53	644	BM-41	269	BS-1	691
BD-251	130	BF-54	644	BM-44	265	BS-23	692
BD-252	131	BF-55	643	BM-45	265	BS-27	692
BD-271	119	BF-59	643	BM-46	266	BS-28	692
BD-272	119	BF-60	643	BM-47	266	BS-30	692
BD-273	119	BF-61	644	BM-48	265	BS-40	692
BD-274	119	BF-62	644	BM-49	265	BS-41	692
BD-275	119	BF-63	644	BM-50	505	BS-42	692
BD-276	119	BF-65	271	BM-51	505		
BD-277	119	BF-68	271	BM-52	266	BT-1	397
BD-278	119	BF-69	271	BM-53	266	BT-2	397
BD-281	120	BF-72	147	BM-60	269	BT-03	322
BD-282	120	BF-73	147	BM-61	246	BT-04	322
BD-287	120	BF-74	147	BM-62	246	BT-05	401
BD-288	120	BF-75	147	BM-63	246	BT-06	401
BD-289	120	BF-78	141	BM-64	246	BT-07	401
BD-290	120	BF-79	141	BM-65	264	BT-10	589
BD-291	120	BF-82	148	BM-66	264	BT-12	589
BD-292	120	BF-85	148	BM-68	268, 505	BT-14	589
BD-303	110	BF-86	148	BM-69	268, 505	BT-15	283
BD-306	110	BF-87	148	BM-70	267	BT-16	283, 617
BD-314	110	BF-88	148	BM-71	267	BT-17	322
BD-315	110	BF-90	148	BM-72	267	BT-18	288
		BF-91	148	BM-73	267	BT-19	288
BF-01	142, 633	BF-92	148	BM-74	268, 505	BT-20	290
BF-02	142, 633	BF-93	148	BM-75	264	BT-22	288
BF-03	139, 633	BF-94	141	BM-76	264	BT-23	297
BF-04	139, 633	BF-95	141	BM-77	264	BT-24	297
BF-05	142	BF-96	630	BM-78	264	BT-25	290
BF-06	142	BF-97	630	BM-79	262	BT-26	288
BF-07	142	BF-100	631	BM-80	262	BT-27	288
BF-08	142			BM-83	263	BT-28	287
BF-10	139	BK-30	533	BM-84	263	BT-29	288
BF-11	141			BM-93	177, 617	BT-31	323
BF-12	139	BM-01	253	BM-95	177, 617	BT-33	299
BF-13	141	BM-02	253	BM-102	270	BT-34	299
BF-14	141	BM-03	253	BM-103	270	BT-35	299
BF-15	141	BM-04	253	BM-104	270	BT-36	299
BF-16	8, 144	BM-09	504	BM-105	270	BT-37	397
BF-18	632	BM-10	504	BM-106	270	BT-38	285
BF-19	632	BM-11	504	BM-107	270	BT-39	285
BF-20	139	BM-12	504	BM-112	270	BT-40	285
BF-22	140	BM-13	504	BM-113	270	BT-41	285
BF-23	140	BM-14	504	BM-114	270	BT-42	285
BF-24	140	BM-15	262	BM-115	270	BT-43	299
BF-25	140	BM-16	262	BM-116	270	BT-44	285





Articolo	Pagina	Articolo	Pagina	Articolo	Pagina	Articolo	Pagina
<b>BT-45</b>	285	<b>BT-124</b>	297	<b>BT-250</b>	301	<b>BV-02</b>	599
<b>BT-46</b>	285	<b>BT-125</b>	297	<b>BT-251</b>	301	<b>BV-04</b>	599
<b>BT-48</b>	287	<b>BT-126</b>	294	<b>BT-252</b>	301	<b>BV-05</b>	599
<b>BT-49</b>	287	<b>BT-127</b>	294	<b>BT-253</b>	301	<b>BV-06</b>	599
<b>BT-50</b>	286	<b>BT-128</b>	294	<b>BT-254</b>	301	<b>BV-07</b>	330
<b>BT-51</b>	286	<b>BT-130</b>	303	<b>BT-255</b>	363	<b>BV-08</b>	327
<b>BT-52</b>	286	<b>BT-131</b>	311	<b>BT-256</b>	363	<b>BV-09</b>	330
<b>BT-54</b>	286	<b>BT-133</b>	311	<b>BT-257</b>	363	<b>BV-10</b>	327
<b>BT-55</b>	286	<b>BT-134</b>	305	<b>BT-258</b>	363	<b>BV-11</b>	329
<b>BT-56</b>	286	<b>BT-135</b>	305	<b>BT-259</b>	363	<b>BV-12</b>	327
<b>BT-57</b>	565	<b>BT-136</b>	304	<b>BT-260</b>	300	<b>BV-13</b>	329
<b>BT-60</b>	300	<b>BT-137</b>	305	<b>BT-261</b>	300	<b>BV-14</b>	328
<b>BT-62</b>	300	<b>BT-139</b>	294	<b>BT-262</b>	300	<b>BV-15</b>	328
<b>BT-64</b>	300	<b>BT-140</b>	294	<b>BT-263</b>	300	<b>BV-16</b>	328
<b>BT-65</b>	300	<b>BT-141</b>	296	<b>BT-274</b>	323	<b>BV-17</b>	328
<b>BT-66</b>	300	<b>BT-142</b>	296	<b>BT-275</b>	293	<b>BV-18</b>	331
<b>BT-67</b>	303	<b>BT-143</b>	296	<b>BT-276</b>	293	<b>BV-19</b>	332
<b>BT-68</b>	303	<b>BT-144</b>	296	<b>BT-277</b>	293	<b>BV-20</b>	331
<b>BT-69</b>	299	<b>BT-145</b>	296	<b>BT-278</b>	293	<b>BV-21</b>	332
<b>BT-70</b>	287, 618	<b>BT-146</b>	296	<b>BT-279</b>	293	<b>BV-22</b>	331
<b>BT-71</b>	287	<b>BT-147</b>	296	<b>BT-280</b>	309	<b>BV-23</b>	332
<b>BT-72</b>	287	<b>BT-148</b>	296	<b>BT-281</b>	309	<b>BV-24</b>	332
<b>BT-73</b>	287	<b>BT-152</b>	302	<b>BT-282</b>	291	<b>BV-25</b>	332
<b>BT-74</b>	287	<b>BT-153</b>	302	<b>BT-283</b>	291	<b>BV-26</b>	330
<b>BT-75</b>	287	<b>BT-154</b>	302	<b>BT-284</b>	291	<b>BV-27</b>	338
<b>BT-77</b>	287	<b>BT-155</b>	302	<b>BT-285</b>	291	<b>BV-28</b>	338
<b>BT-79</b>	287	<b>BT-156</b>	302	<b>BT-286</b>	291	<b>BV-30</b>	357
<b>BT-80</b>	306	<b>BT-157</b>	302	<b>BT-287</b>	291	<b>BV-31</b>	357
<b>BT-81</b>	306	<b>BT-160</b>	320	<b>BT-288</b>	291	<b>BV-32</b>	357
<b>BT-82</b>	306	<b>BT-161</b>	320	<b>BT-289</b>	291	<b>BV-33</b>	357
<b>BT-83</b>	291	<b>BT-162</b>	320	<b>BT-290</b>	309	<b>BV-35</b>	350
<b>BT-84</b>	576	<b>BT-163</b>	320	<b>BT-291</b>	290	<b>BV-36</b>	327
<b>BT-85</b>	576	<b>BT-164</b>	320	<b>BT-294</b>	290	<b>BV-37</b>	327
<b>BT-86</b>	576	<b>BT-165</b>	320	<b>BT-296</b>	289	<b>BV-38</b>	327
<b>BT-87</b>	576	<b>BT-166</b>	321	<b>BT-297</b>	289	<b>BV-39</b>	327
<b>BT-88</b>	576	<b>BT-167</b>	321	<b>BT-298</b>	289	<b>BV-40</b>	358
<b>BT-89</b>	576	<b>BT-168</b>	321	<b>BT-299</b>	289	<b>BV-41</b>	358
<b>BT-90</b>	304	<b>BT-180</b>	306	<b>BT-312</b>	292	<b>BV-42</b>	358
<b>BT-91</b>	304	<b>BT-181</b>	306	<b>BT-315</b>	309	<b>BV-43</b>	358
<b>BT-92</b>	302	<b>BT-182</b>	306	<b>BT-316</b>	309	<b>BV-45</b>	327
<b>BT-93</b>	302	<b>BT-190</b>	285	<b>BT-317</b>	309	<b>BV-46</b>	360
<b>BT-94</b>	302	<b>BT-191</b>	285	<b>BT-318</b>	309	<b>BV-47</b>	327
<b>BT-95</b>	302	<b>BT-192</b>	285	<b>BT-319</b>	310	<b>BV-48</b>	327
<b>BT-96</b>	302	<b>BT-193</b>	285	<b>BT-320</b>	310	<b>BV-49</b>	327
<b>BT-97</b>	312	<b>BT-194</b>	285	<b>BT-321</b>	310	<b>BV-51</b>	327
<b>BT-98</b>	312	<b>BT-195</b>	285	<b>BT-322</b>	310	<b>BV-52</b>	327
<b>BT-99</b>	312	<b>BT-203</b>	283	<b>BT-327</b>	308	<b>BV-55</b>	331
<b>BT-100</b>	302	<b>BT-204</b>	283	<b>BT-328</b>	308	<b>BV-56</b>	331
<b>BT-101</b>	295	<b>BT-207</b>	283	<b>BT-329</b>	308	<b>BV-57</b>	367
<b>BT-102</b>	295	<b>BT-208</b>	283	<b>BT-330</b>	308	<b>BV-58</b>	366
<b>BT-103</b>	295	<b>BT-210</b>	284	<b>BT-331</b>	319	<b>BV-59</b>	366
<b>BT-104</b>	295	<b>BT-211</b>	284	<b>BT-332</b>	319	<b>BV-60</b>	365
<b>BT-105</b>	295	<b>BT-212</b>	284	<b>BT-333</b>	319	<b>BV-62</b>	365
<b>BT-106</b>	295	<b>BT-213</b>	284	<b>BT-334</b>	319	<b>BV-64</b>	365
<b>BT-107</b>	295	<b>BT-214</b>	284	<b>BT-335</b>	319	<b>BV-66</b>	365
<b>BT-108</b>	295	<b>BT-215</b>	284	<b>BT-336</b>	319	<b>BV-68</b>	341
<b>BT-109</b>	288	<b>BT-216</b>	284	<b>BT-341</b>	317	<b>BV-69</b>	341
<b>BT-110</b>	301	<b>BT-217</b>	284	<b>BT-342</b>	317	<b>BV-70</b>	341
<b>BT-111</b>	301	<b>BT-218</b>	284	<b>BT-344</b>	318	<b>BV-71</b>	341
<b>BT-112</b>	301	<b>BT-220</b>	313	<b>BT-345</b>	318	<b>BV-72</b>	341
<b>BT-113</b>	292	<b>BT-221</b>	313	<b>BT-347</b>	315	<b>BV-73</b>	341
<b>BT-114</b>	292	<b>BT-222</b>	313	<b>BT-348</b>	315	<b>BV-74</b>	341
<b>BT-115</b>	292	<b>BT-223</b>	313	<b>BT-349</b>	315	<b>BV-75</b>	341
<b>BT-116</b>	292	<b>BT-227</b>	314	<b>BT-350</b>	315	<b>BV-76</b>	335
<b>BT-117</b>	292	<b>BT-228</b>	314	<b>BT-357</b>	324	<b>BV-77</b>	335
<b>BT-118</b>	292	<b>BT-229</b>	314	<b>BT-358</b>	324	<b>BV-78</b>	335
<b>BT-120</b>	298	<b>BT-246</b>	307	<b>BT-359</b>	324	<b>BV-79</b>	335
<b>BT-121</b>	298	<b>BT-247</b>	307	<b>BT-360</b>	316	<b>BV-80</b>	356
<b>BT-122</b>	298	<b>BT-248</b>	307	<b>BT-361</b>	316	<b>BV-82</b>	356
<b>BT-123</b>	298	<b>BT-249</b>	307			<b>BV-84</b>	356



Articolo	Pagina	Articolo	Pagina	Articolo	Pagina	Articolo	Pagina
<b>BV-85</b>	356	<b>BV-176</b>	351	<b>BV-275</b>	352	<b>BV-355</b>	369
<b>BV-86</b>	356	<b>BV-177</b>	351	<b>BV-276</b>	352	<b>BV-357</b>	369
<b>BV-88</b>	336	<b>BV-178</b>	351	<b>BV-277</b>	352	<b>BV-358</b>	369
<b>BV-89</b>	336	<b>BV-179</b>	351	<b>BV-279</b>	352	<b>BV-359</b>	369
<b>BV-90</b>	333	<b>BV-180</b>	351	<b>BV-280</b>	352	<b>BV-360</b>	369
<b>BV-91</b>	333	<b>BV-181</b>	351	<b>BV-281T</b>	353	<b>BV-366</b>	348
<b>BV-92</b>	333	<b>BV-182</b>	351	<b>BV-282T</b>	353	<b>BV-367</b>	348
<b>BV-93</b>	333	<b>BV-183</b>	349	<b>BV-283T</b>	353	<b>BV-368</b>	348
<b>BV-94</b>	334	<b>BV-184</b>	359	<b>BV-284T</b>	353	<b>BV-369</b>	348
<b>BV-95</b>	334	<b>BV-185</b>	359	<b>BV-285T</b>	353	<b>BV-370</b>	348
<b>BV-96</b>	334	<b>BV-186</b>	359	<b>BV-286T</b>	353	<b>BV-371</b>	348
<b>BV-97</b>	334	<b>BV-187</b>	359	<b>BV-287T</b>	353	<b>BV-372</b>	346, 347
<b>BV-98</b>	336	<b>BV-188</b>	359	<b>BV-288T</b>	353	<b>BV-373</b>	347
<b>BV-99</b>	336	<b>BV-189</b>	359	<b>BV-289T</b>	353	<b>BV-374</b>	347
<b>BV-101</b>	337	<b>BV-190</b>	339	<b>BV-290T</b>	353	<b>BV-375</b>	347
<b>BV-102</b>	337	<b>BV-191</b>	339	<b>BV-291T</b>	353	<b>BV-376</b>	347
<b>BV-108</b>	329	<b>BV-192</b>	339	<b>BV-292T</b>	353	<b>BV-377</b>	347
<b>BV-109</b>	329	<b>BV-193</b>	339	<b>BV-293T</b>	353	<b>BV-378</b>	347
<b>BV-110</b>	335	<b>BV-194</b>	349	<b>BV-294T</b>	353	<b>BV-379</b>	347
<b>BV-111</b>	330	<b>BV-195</b>	349	<b>BV-295T</b>	353	<b>BV-380</b>	347
<b>BV-112</b>	330	<b>BV-196</b>	349	<b>BV-296T</b>	353	<b>BV-381</b>	347
<b>BV-117</b>	335	<b>BV-197</b>	349	<b>BV-297T</b>	353	<b>BV-382</b>	347
<b>BV-118</b>	335	<b>BV-198</b>	349	<b>BV-298T</b>	353	<b>BV-383</b>	363
<b>BV-119</b>	338	<b>BV-199</b>	349	<b>BV-299T</b>	353	<b>BV-384</b>	363
<b>BV-120</b>	338	<b>BV-200</b>	349	<b>BV-300T</b>	353	<b>BV-385</b>	363
<b>BV-121</b>	342	<b>BV-201</b>	354	<b>BV-301T</b>	353	<b>BV-386</b>	363
<b>BV-122</b>	342	<b>BV-202</b>	354	<b>BV-302T</b>	353	<b>BV-387</b>	363
<b>BV-123</b>	343	<b>BV-203</b>	354	<b>BV-303T</b>	353	<b>BV-388</b>	363
<b>BV-124</b>	343	<b>BV-204</b>	354	<b>BV-304T</b>	353	<b>BV-389</b>	363
<b>BV-125</b>	367	<b>BV-205</b>	354	<b>BV-305T</b>	353	<b>BV-390</b>	363
<b>BV-126</b>	367	<b>BV-206</b>	354	<b>BV-306T</b>	353		
<b>BV-128</b>	367	<b>BV-207</b>	354	<b>BV-307T</b>	353	<b>C-1</b>	415
<b>BV-130</b>	340	<b>BV-208</b>	354	<b>BV-308T</b>	353	<b>C-2</b>	415
<b>BV-131</b>	340	<b>BV-209</b>	355	<b>BV-309T</b>	353	<b>C-3</b>	415
<b>BV-135</b>	344	<b>BV-210</b>	355	<b>BV-310T</b>	353	<b>C-4</b>	415
<b>BV-136</b>	344	<b>BV-211</b>	355	<b>BV-317</b>	345		
<b>BV-137</b>	344	<b>BV-212</b>	355	<b>BV-318</b>	345	<b>CS-01</b>	691
<b>BV-138</b>	344	<b>BV-213</b>	355	<b>BV-319</b>	345	<b>CS-02</b>	691
<b>BV-139</b>	344	<b>BV-214</b>	355	<b>BV-320</b>	345	<b>CS-03</b>	691
<b>BV-141</b>	346	<b>BV-215</b>	355	<b>BV-321</b>	345	<b>CS-04</b>	691
<b>BV-142</b>	346	<b>BV-216</b>	355	<b>BV-322</b>	345	<b>CS-05</b>	691
<b>BV-143</b>	346	<b>BV-229</b>	353	<b>BV-323</b>	345	<b>CS-06</b>	691
<b>BV-144</b>	349	<b>BV-241</b>	370	<b>BV-324</b>	345	<b>CS-07</b>	693
<b>BV-145</b>	346	<b>BV-242</b>	370	<b>BV-325</b>	345	<b>CS-08</b>	693
<b>BV-146</b>	346	<b>BV-245</b>	370	<b>BV-326</b>	345	<b>CS-09</b>	693
<b>BV-148</b>	346	<b>BV-246</b>	370	<b>BV-327</b>	345	<b>CS-12</b>	694
<b>BV-150</b>	360	<b>BV-247</b>	370	<b>BV-328</b>	345	<b>CS-15</b>	694
<b>BV-151</b>	360	<b>BV-248</b>	370	<b>BV-329</b>	345	<b>CS-19</b>	694
<b>BV-152</b>	360	<b>BV-249</b>	352	<b>BV-330</b>	345	<b>CS-20</b>	694
<b>BV-153</b>	359	<b>BV-250</b>	352	<b>BV-331</b>	361	<b>CS-21</b>	694
<b>BV-156</b>	359	<b>BV-251</b>	352	<b>BV-332</b>	361	<b>CS-22</b>	694
<b>BV-157</b>	359	<b>BV-252</b>	352	<b>BV-333</b>	361	<b>CS-25</b>	694
<b>BV-158</b>	349	<b>BV-253</b>	352	<b>BV-334</b>	361	<b>CS-30</b>	694
<b>BV-159</b>	349	<b>BV-254</b>	352	<b>BV-335</b>	361	<b>CS-32</b>	694
<b>BV-160</b>	350	<b>BV-255</b>	352	<b>BV-336</b>	361	<b>CS-33</b>	694
<b>BV-161</b>	350	<b>BV-256</b>	352	<b>BV-337</b>	361	<b>CS-34</b>	694
<b>BV-162</b>	349	<b>BV-257</b>	352	<b>BV-338</b>	361	<b>CS-40</b>	694
<b>BV-163</b>	351	<b>BV-258</b>	352	<b>BV-339</b>	361	<b>CS-41</b>	694
<b>BV-164</b>	351	<b>BV-259</b>	352	<b>BV-340</b>	362	<b>CS-42</b>	694
<b>BV-165</b>	351	<b>BV-260</b>	352	<b>BV-341</b>	362	<b>CS-43</b>	694
<b>BV-166</b>	351	<b>BV-262</b>	364	<b>BV-342</b>	362	<b>CS-44</b>	694
<b>BV-167</b>	351	<b>BV-263</b>	364	<b>BV-343</b>	362	<b>CS-45</b>	694
<b>BV-168</b>	351	<b>BV-264</b>	364	<b>BV-344</b>	362	<b>CS-51</b>	691
<b>BV-169</b>	351	<b>BV-265</b>	364	<b>BV-345</b>	362	<b>CS-52</b>	691
<b>BV-170</b>	351	<b>BV-269</b>	352	<b>BV-346</b>	361	<b>CS-55</b>	691
<b>BV-171</b>	351	<b>BV-270</b>	352	<b>BV-347</b>	361	<b>CS-61</b>	693
<b>BV-172</b>	351	<b>BV-271</b>	352	<b>BV-348</b>	361	<b>CS-63</b>	693
<b>BV-173</b>	351	<b>BV-272</b>	352	<b>BV-349</b>	362	<b>CS-65</b>	693
<b>BV-174</b>	351	<b>BV-273</b>	352	<b>BV-350</b>	362	<b>CS-66</b>	693
<b>BV-175</b>	351	<b>BV-274</b>	352	<b>BV-354</b>	369	<b>CS-67</b>	693



Articolo	Pagina	Articolo	Pagina	Articolo	Pagina	Articolo	Pagina
<b>CS-80</b>	691	<b>DO-16</b>	562	<b>DO-96</b>	546	<b>DO-187</b>	578
<b>CS-81</b>	691	<b>DO-17</b>	562	<b>DO-97</b>	546	<b>DO-188</b>	578
<b>CS-82</b>	691	<b>DO-18</b>	437	<b>DO-98</b>	387	<b>DO-190</b>	440
<b>CS-83</b>	691	<b>DO-19</b>	549	<b>DO-99</b>	387	<b>DO-191</b>	440
		<b>DO-20</b>	567	<b>DO-101</b>	400	<b>DO-192</b>	440
<b>DB-1L</b>	687	<b>DO-21</b>	567	<b>DO-102</b>	400	<b>DO-193</b>	440
<b>DB-4</b>	688	<b>DO-22</b>	567	<b>DO-103</b>	400	<b>DO-194</b>	440
<b>DB-5L</b>	687	<b>DO-23</b>	567	<b>DO-104</b>	387	<b>DO-195</b>	440
<b>DB-6-A</b>	688	<b>DO-24</b>	567	<b>DO-105</b>	387	<b>DO-196</b>	440
<b>DB-20</b>	551	<b>DO-25</b>	567	<b>DO-106</b>	400	<b>DO-197</b>	440
<b>DB-21</b>	551, 617	<b>DO-26</b>	567	<b>DO-107</b>	400	<b>DO-198</b>	546
<b>DB-22-A</b>	688	<b>DO-27</b>	567	<b>DO-108</b>	388	<b>DO-199</b>	546
<b>DB-23</b>	551	<b>DO-29</b>	549	<b>DO-109</b>	573	<b>DO-203</b>	581
<b>DB-24</b>	551	<b>DO-30</b>	489	<b>DO-110</b>	568	<b>DO-205</b>	581
<b>DB-25</b>	551	<b>DO-31</b>	489	<b>DO-111</b>	396	<b>DO-206</b>	581
<b>DB-30</b>	551	<b>DO-32</b>	489	<b>DO-112</b>	568	<b>DO-213</b>	289
<b>DB-31</b>	551	<b>DO-34</b>	566	<b>DO-117</b>	399	<b>DO-214</b>	289
<b>DB-32</b>	551	<b>DO-35</b>	566	<b>DO-118</b>	577	<b>DO-215</b>	289
<b>DB-36</b>	551	<b>DO-36</b>	566	<b>DO-119</b>	577	<b>DO-220</b>	386
<b>DB-37</b>	551	<b>DO-40</b>	545	<b>DO-120</b>	568	<b>DO-221</b>	386
<b>DB-38</b>	551	<b>DO-41</b>	545	<b>DO-121</b>	568	<b>DO-222</b>	386
<b>DB-39</b>	551	<b>DO-42</b>	545	<b>DO-122</b>	568	<b>DO-223</b>	386
<b>DB-96</b>	688	<b>DO-43</b>	545	<b>DO-125</b>	547	<b>DO-224</b>	386
<b>DB-97</b>	552	<b>DO-44</b>	489	<b>DO-126</b>	547	<b>DO-240</b>	396
<b>DB-98</b>	552	<b>DO-45</b>	388, 547	<b>DO-130</b>	438	<b>DO-241</b>	396
<b>DB-99</b>	552	<b>DO-46</b>	388, 547	<b>DO-131</b>	438	<b>DO-242</b>	381
<b>DB-100</b>	554	<b>DO-47</b>	396	<b>DO-132</b>	438	<b>DO-243</b>	381
<b>DB-101</b>	459	<b>DO-48</b>	565	<b>DO-133</b>	438	<b>DO-244</b>	396
<b>DB-102</b>	459	<b>DO-49</b>	489	<b>DO-138</b>	400	<b>DO-247</b>	548
<b>DB-103</b>	459	<b>DO-50</b>	569	<b>DO-139</b>	400	<b>DO-248</b>	548
<b>DB-104</b>	459	<b>DO-51</b>	569	<b>DO-140</b>	438	<b>DO-250</b>	582
<b>DB-105</b>	459	<b>DO-52</b>	569	<b>DO-141</b>	438	<b>DO-251</b>	582
<b>DB-106</b>	554	<b>DO-53</b>	569	<b>DO-142</b>	545	<b>DO-252</b>	582
<b>DB-107</b>	554	<b>DO-54</b>	569	<b>DO-143</b>	438	<b>DO-257</b>	581
<b>DB-108</b>	554	<b>DO-55</b>	569	<b>DO-144</b>	565	<b>DO-258</b>	581
<b>DB-109</b>	554	<b>DO-56</b>	289	<b>DO-145</b>	565	<b>DO-260</b>	582
<b>DB-111</b>	552	<b>DO-57</b>	289	<b>DO-146</b>	565	<b>DO-261</b>	582
<b>DB-113</b>	552	<b>DO-58</b>	289	<b>DO-147</b>	563	<b>DO-262</b>	582
<b>DB-114</b>	552	<b>DO-59</b>	398	<b>DO-148</b>	563	<b>DO-264</b>	564
<b>DB-120</b>	553	<b>DO-60</b>	396	<b>DO-149</b>	563	<b>DO-274</b>	575
<b>DB-121</b>	553	<b>DO-63</b>	398	<b>DO-150</b>	579	<b>DO-285</b>	575
<b>DB-122</b>	553	<b>DO-65</b>	398	<b>DO-151</b>	579	<b>DO-286</b>	575
<b>DB-123</b>	553	<b>DO-67</b>	398	<b>DO-152</b>	579	<b>DO-287</b>	575
<b>DB-124</b>	553	<b>DO-68</b>	399	<b>DO-153</b>	579	<b>DO-290</b>	575
<b>DB-125</b>	553	<b>DO-69</b>	399	<b>DO-154</b>	579		
<b>DB-129</b>	553	<b>DO-70</b>	409	<b>DO-155</b>	579	<b>DP-08</b>	506
<b>DB-141</b>	459	<b>DO-71</b>	409	<b>DO-156</b>	579	<b>DP-09</b>	488
<b>DB-143</b>	459	<b>DO-72</b>	573	<b>DO-157</b>	563	<b>DP-18</b>	506
<b>DB-145</b>	459	<b>DO-73</b>	574	<b>DO-158</b>	579	<b>DP-71</b>	506
<b>DB-150</b>	648	<b>DO-74</b>	574	<b>DO-161</b>	580	<b>DP-75</b>	506
<b>DB-180</b>	453	<b>DO-75</b>	409	<b>DO-162</b>	580	<b>DP-90</b>	102, 512
<b>DB-181</b>	453	<b>DO-76</b>	409	<b>DO-163</b>	580	<b>DP-91</b>	103
<b>DB-182</b>	453	<b>DO-77</b>	573	<b>DO-164</b>	580	<b>DP-92</b>	103
<b>DB-299</b>	688	<b>DO-78</b>	573	<b>DO-165</b>	580	<b>DP-96</b>	508
<b>DB-OL</b>	688	<b>DO-79</b>	410	<b>DO-166</b>	580	<b>DP-101</b>	103
<b>DB-OLR</b>	687	<b>DO-80</b>	410	<b>DO-167</b>	580	<b>DP-102</b>	103
		<b>DO-81</b>	410	<b>DO-168</b>	412, 572	<b>DP-103</b>	103
<b>DEAN</b>	70	<b>DO-82</b>	410	<b>DO-169</b>	412, 572	<b>DP-104</b>	103
		<b>DO-83</b>	410	<b>DO-170</b>	577	<b>DP-105</b>	103
<b>DO-1</b>	408, 570	<b>DO-84</b>	577	<b>DO-171</b>	577	<b>DP-120</b>	102, 512
<b>DO-2</b>	408, 570	<b>DO-85</b>	577	<b>DO-172</b>	577	<b>DP-725</b>	22
<b>DO-3</b>	408, 570	<b>DO-86</b>	388	<b>DO-174</b>	289		
<b>DO-08</b>	544	<b>DO-87</b>	573	<b>DO-175</b>	311	<b>DR-50</b>	134
<b>DO-09</b>	544	<b>DO-88</b>	575	<b>DO-178</b>	409	<b>DR-60</b>	134
<b>DO-10</b>	550	<b>DO-89</b>	575	<b>DO-179</b>	574		
<b>DO-11</b>	550	<b>DO-90</b>	399	<b>DO-180</b>	578	<b>DS-01</b>	543
<b>DO-12</b>	550	<b>DO-91</b>	565	<b>DO-181</b>	578	<b>DS-02</b>	543
<b>DO-13</b>	550	<b>DO-92</b>	565	<b>DO-182</b>	578		
<b>DO-14</b>	550	<b>DO-94</b>	546	<b>DO-185</b>	578	<b>EA-10</b>	172
<b>DO-15</b>	550	<b>DO-95</b>	546	<b>DO-186</b>	578	<b>EA-11</b>	172



Articolo	Pagina	Articolo	Pagina	Articolo	Pagina	Articolo	Pagina
EA-12	172	EB-55	641	EB-144	636	EB-253	626
EA-13	172	EB-56	641	EB-150	637	EB-254	626
EA-14	172	EB-57	641	EB-151	637	EB-255	626
EA-15	172	EB-58	641	EB-152	637	EB-256	626
EA-20	174	EB-59	641	EB-156	637	EB-257	626
EA-21	174	EB-60	641	EB-157	637	EB-258	626
EA-30	171	EB-61	641	EB-158	637	EB-259	626
EA-31	171	EB-62	641	EB-160	637	EB-260	626
EA-32	171	EB-63	641	EB-162	637	EB-261	626
EA-33	171	EB-64	641	EB-163	637	EB-262	626
EA-36	171	EB-65	641	EB-164	637	EB-263	626
EA-37	171	EB-66	641	EB-166	637	EB-264	626
EA-40	369	EB-67	641	EB-170	638	EB-265	626
EA-50	173	EB-68	641	EB-171	638	EB-266	626
EA-51	173	EB-69	641	EB-172	638	EB-267	626
EA-52	173	EB-70	641	EB-173	638		
EA-53	173	EB-71	641	EB-174	638	ER-11	653
EA-54	173	EB-72	641	EB-175	638	ER-12	653
EA-55	173	EB-73	641	EB-176	638	ER-13	653
EA-60	624	EB-74	641	EB-177	638	ER-14	653
EA-62	624	EB-75	641	EB-178	638	ER-15	653
EA-63	624	EB-76	641	EB-179	638	ER-16	653
EA-64	624	EB-77	641	EB-184	638	ER-17	653
EA-65	624	EB-78	641	EB-189	638	ER-18	653
EA-66	624	EB-79	641	EB-190	637	ER-21	653
EA-67	624	EB-80	641	EB-191	637	ER-22	653
EA-70	624	EB-81	641	EB-201	626	ER-23	653
EA-72	624	EB-82	641	EB-202	626	ER-24	653
EA-74	624	EB-83	641	EB-203	626	ER-25	653
EA-76	624	EB-84	641	EB-204	626	ER-26	653
EA-77	624	EB-85	641	EB-205	626	ER-27	653
EA-78	624	EB-86	641	EB-206	626	ER-28	653
EA-79	624	EB-87	641	EB-207	626	ER-31	654
EA-90	624	EB-88	641	EB-208	626	ER-32	654
EA-91	624	EB-89	641	EB-209	626	ER-41	654
EA-92	624	EB-90	641	EB-210	626	ER-42	654
EA-93	624	EB-91	641	EB-211	626	ER-46	634
		EB-92	641	EB-212	626	ER-47	634
		EB-93	641	EB-213	626	ER-48	634
EB-11	623	EB-100	635	EB-214	626	ER-49	634
EB-12	623	EB-101	635	EB-215	626	ER-50	656
EB-13	623	EB-102	635	EB-216	626	ER-51	656
EB-14	623	EB-103	635	EB-217	626	ER-52	656
EB-15	645	EB-104	635	EB-218	626	ER-53	656
EB-16	645	EB-105	635	EB-219	626	ER-61	634
EB-18	628	EB-106	635	EB-220	626	ER-62	634
EB-19	628	EB-107	635	EB-221	626	ER-63	634
EB-20	628	EB-120	636	EB-222	626	ER-72	634
EB-21	651	EB-121	636	EB-223	626	ER-73	634
EB-22	651	EB-122	636	EB-231	628	ER-74	634
EB-23	651	EB-123	636	EB-232	628	ER-77	646
EB-25	644	EB-124	636	EB-233	628	ER-78	646
EB-30	629	EB-125	636	EB-234	628	ER-79	646
EB-31	175, 629	EB-126	636	EB-235	628	ER-80	651
EB-32	175, 629	EB-127	636	EB-236	628	ER-81	651
EB-36	623	EB-128	636	EB-237	628	ER-82	651
EB-37	623	EB-130	636	EB-238	628	ER-83	651
EB-38	623	EB-131	636	EB-239	628	ER-84	651
EB-39	623	EB-132	636	EB-240	628	ER-88	652
EB-42	627	EB-133	636	EB-241	628	ER-90	652
EB-43	627	EB-134	636	EB-242	628	ER-91	634
EB-44	627	EB-135	636	EB-243	628	ER-92	634
EB-45	627	EB-136	636	EB-244	628	ER-93	634
EB-46	627	EB-137	636	EB-245	628	ER-96	634
EB-47	627	EB-138	636	EB-246	628	ER-97	634
EB-48	627	EB-139	636	EB-247	628	ER-100	642
EB-49	627	EB-140	636	EB-248	628	ER-101	642
EB-51	641	EB-141	636	EB-249	628	ER-102	642
EB-52	641	EB-142	636	EB-251	626	ER-103	642
EB-53	641	EB-143	636	EB-252	626	ER-104	642
EB-54	641						



Articolo	Pagina	Articolo	Pagina	Articolo	Pagina	Articolo	Pagina
ER-105	642	FB-20	188	FB-91	185	FB-180	197
ER-106	642	FB-21	189	FB-92	185	FB-181	197
ER-107	642	FB-22	187	FB-93	185	FB-182	197
ER-108	642	FB-23	187	FB-94	205	FB-183	197
ER-110	640	FB-24	187	FB-95	205	FB-184	207
ER-111	640	FB-25	197	FB-96	217	FB-185	207
ER-112	640	FB-26	197	FB-97	217	FB-186	207
ER-113	640	FB-27	197	FB-98	217	FB-187	216
ER-114	640	FB-28	197	FB-99	217	FB-188	215
ER-115	640	FB-29	191	FB-101	229	FB-189	216
ER-116	640	FB-30	191	FB-103	229	FB-190	213
ER-117	640	FB-31	191	FB-107	228	FB-191	189
ER-118	640	FB-32	191	FB-108	228	FB-192	216
ER-120	639	FB-33	191	FB-109	228	FB-193	216
ER-121	639	FB-34	191	FB-110	207	FB-194	216
ER-122	639	FB-35	190	FB-111	207	FB-195	214
ER-123	639	FB-36	190	FB-112	207	FB-196	214
ER-124	639	FB-37	190	FB-113	222	FB-197	214
ER-125	639	FB-38	194	FB-114	222	FB-198	214
ER-126	639	FB-39	194	FB-125	208	FB-199	214
ER-127	639	FB-40	194	FB-126	208	FB-201	184
ER-128	639	FB-41	176, 630	FB-127	208	FB-202	184
ER-129	639	FB-42	176	FB-128	208	FB-203	184
ER-130	639	FB-43	176, 631	FB-129	208	FB-204	184
ER-131	639	FB-44	194	FB-130	208	FB-205	184
ER-132	639	FB-45	186	FB-131	206	FB-206	213
ER-140	655	FB-46	225	FB-132	206	FB-207	213
ER-141	655	FB-47	186	FB-133	188	FB-209	213
ER-142	655	FB-48	186	FB-138	202	FB-210	213
ER-143	655	FB-49	186	FB-139	202	FB-211	183
ER-144	655	FB-50	211	FB-140	196	FB-212	183
ER-145	655	FB-51	211	FB-141	196	FB-213	183
ER-146	655	FB-52	224	FB-142	196	FB-214	183
ER-150	645	FB-53	224	FB-143	203	FB-215	183
ER-151	645	FB-54	224	FB-144	203	FB-216	185
ER-152	645	FB-55	186	FB-145	204	FB-217	185
ER-161	641	FB-57	186	FB-146	204	FB-236	182
ER-162	641	FB-58	186	FB-147	199	FB-237	182
ER-163	641	FB-59	186	FB-148	199	FB-238	182
ER-164	641	FB-60	180	FB-149	199	FB-239	182
ER-165	641	FB-61	180	FB-150	199	FB-241	181
ER-166	641	FB-62	180	FB-151	199	FB-242	181
		FB-63	180	FB-152	200	FB-243	181
ES-44	135	FB-64	180	FB-153	200	FB-244	181
ES-45	135	FB-65	180	FB-154	200	FB-245	181
ES-46	135	FB-66	180	FB-155	200	FB-246	181
ES-47	135	FB-67	178	FB-156	209	FB-247	181
ES-48	135	FB-68	178	FB-157	209	FB-248	181
ES-64	135	FB-69	178	FB-158	209	FB-249	181
ES-65	135	FB-70	178	FB-159	210	FB-251	182
		FB-71	178	FB-160	210	FB-252	182
FB-01	187	FB-72	178	FB-161	195	FB-253	182
FB-02	187	FB-73	178	FB-162	195	FB-254	182
FB-03	189	FB-74	178	FB-163	195	FB-255	182
FB-04	189	FB-75	178	FB-164	195	FB-256	182
FB-05	189	FB-76	179	FB-165	193	FB-257	182
FB-06	215	FB-77	179	FB-166	193	FB-265	198
FB-07	215	FB-78	179	FB-167	193	FB-266	198
FB-08	192	FB-79	179	FB-168	201	FB-267	198
FB-09	192	FB-80	179	FB-169	201	FB-268	219
FB-10	192	FB-81	179	FB-170	201	FB-269	219
FB-11	212	FB-82	179	FB-171	201	FB-270	219
FB-12	212	FB-83	179	FB-172	201	FB-271	220
FB-13	212	FB-84	177	FB-173	201	FB-272	220
FB-14	187	FB-85	177	FB-174	201	FB-273	218
FB-15	187	FB-86	177	FB-175	201	FB-274	218
FB-16	214	FB-87	177	FB-176	221	FB-280	212
FB-17	192	FB-88	225	FB-177	221	FB-281	212
FB-18	190	FB-89	225	FB-178	221	FB-283	212
FB-19	188	FB-90	185	FB-179	211	FB-296	368



Articolo	Pagina	Articolo	Pagina	Articolo	Pagina	Articolo	Pagina
FB-297	368	FD-01	605	FD-79	39, 600, 619	FD-191	40
FB-298	368	FD-02	605	FD-80	39, 600, 619	FD-201	109
FB-300	226	FD-03	602	FD-81	39, 600, 619	FD-202	109
FB-301	226	FD-04	602	FD-82	607	FD-203	109, 233
FB-302	226	FD-05	602, 617	FD-83	607	FD-204	109, 233
FB-303	226	FD-06	39	FD-84	607, 617	FD-211	233
FB-304	226	FD-07	605	FD-85	607, 617	FD-213	233
FB-305	226	FD-08	39	FD-86	607	FD-214	610
FB-306	226	FD-09	605	FD-87	607	FD-215	610
FB-307	226	FD-10	39, 601	FD-88	607	FD-216	610
FB-308	226	FD-11	604	FD-89	607	FD-218	241
FB-309	226	FD-12	39, 601	FD-90	608	FD-219	241
FB-310	226	FD-13	39, 601	FD-91	608	FD-221	41
FB-311	226	FD-14	238	FD-92	608	FD-223	41
FB-312	226	FD-15	601	FD-93	608	FD-231	600
FB-320	625	FD-16	238	FD-94	608	FD-232	600
FB-321	625	FD-17	238	FD-95	608	FD-233	600
FB-322	625	FD-18	238	FD-105	234, 609, 620	FD-234	600
FB-323	625	FD-19	238	FD-106	234, 609	FD-235	604
FB-324	625	FD-20	238	FD-107	234, 609	FD-240	607
FB-325	625	FD-21	239	FD-108	234, 609	FD-241	607
FB-326	625	FD-22	239	FD-109	609	FD-242	608
FB-327	625	FD-23	239	FD-110	609	FD-243	608
FB-328	625	FD-24	234	FD-111	609	FD-244	608, 620
FB-329	625	FD-25	239	FD-112	609	FD-245	608
FB-330	625	FD-27	240	FD-113	234	FD-246	235
FB-331	625	FD-28	239	FD-114	234	FD-247	235
FB-332	625	FD-29	239	FD-115	234	FD-248	235
FB-333	625	FD-30	241	FD-116	234	FD-249	235
FB-334	625	FD-31	242	FD-118	595, 618, 619	FD-306	42
FB-335	625	FD-32	241	FD-119	595	FD-307	42
FB-336	625	FD-33	240	FD-120	595	FD-310	42
FB-337	625	FD-34	242	FD-121	611	FD-311	42
FB-338	625	FD-35	240	FD-122	611	FD-318	237
FB-339	625	FD-36	242	FD-123	595, 618, 619	FD-319	237
FB-340	625	FD-37	242	FD-124	597, 617	FD-320	237
FB-341	625	FD-38	242	FD-125	597	FD-321	237
FB-342	625	FD-39	240	FD-126	597	FD-326	237
FB-343	625	FD-40	606	FD-127	597	FD-327	237
FB-350	227	FD-41	602	FD-128	240	FD-328	237
FB-351	227	FD-42	602, 617	FD-129	620	FD-329	237
FB-352	227	FD-43	605	FD-130	597	FD-408	43
FB-353	227	FD-44	605	FD-132	597, 618, 619	FD-409	43
FB-354	227	FD-45	39	FD-134	597	FD-410	43
FB-355	227	FD-46	39	FD-135	617	FD-411	43
FB-356	227	FD-49	602	FD-136	597, 619	FD-412	43
FB-357	227	FD-50	602	FD-137	41, 606	FD-420	236
FB-358	227	FD-51	605	FD-138	41, 606	FD-421	236
FB-359	227	FD-52	605	FD-146	604	FD-423	236
FB-360	227	FD-54	617	FD-147	604		
FB-361	227	FD-55	602	FD-148	241	FF-10	557
FB-362	227	FD-56	602	FD-149	241	FF-11	557
FB-363	227	FD-57	605	FD-150	609	FF-12	557
FB-364	227	FD-58	605	FD-151	609	FF-13	557
FB-365	227	FD-59	606	FD-152	610	FF-14	556
FB-366	227	FD-60	606	FD-153	610	FF-15	556
FB-367	227	FD-61	604	FD-154	610	FF-16	556
FB-368	227	FD-62	604	FD-155	610	FF-17	556
FB-369	227	FD-63	235	FD-156	610	FF-20	465
FB-380	228	FD-64	601	FD-157	610	FF-21	465
FB-381	228	FD-65	601	FD-158	617	FF-22	465
FB-382	228	FD-66	603	FD-159	617	FF-23	465
FB-383	228	FD-67	603	FD-160	608	FF-30	647
FB-384	228	FD-68	603	FD-161	608	FF-31	648
FB-385	228	FD-69	603, 619	FD-162	609	FF-32	647
FB-386	228	FD-70	603, 619	FD-165	611	FF-33	647
FB-387	228	FD-71	603	FD-166	611	FF-34	647
FB-388	228	FD-72	603	FD-169	611	FF-35	649
FB-389	228	FD-73	603	FD-186	40	FF-36	649
		FD-74	603	FD-187	40	FF-37	649



Articolo	Pagina	Articolo	Pagina	Articolo	Pagina	Articolo	Pagina
FF-38	648	FF-214	559	FG-56	51	FG-157	49
FF-39	648	FF-215	559	FG-57	51	FG-158	49
FF-59	650	FF-216	559	FG-58	47	FG-159	49
FF-60	650	FF-401	555	FG-60	63	FG-160	102
FF-61	650	FF-402	555	FG-61	63	FG-161	102
FF-62	650	FF-403	555	FG-63	97	FG-167	84
FF-64	649	FF-404	555	FG-64	97	FG-168	84
FF-70	460	FF-411	555	FG-66	52	FG-180	79
FF-71	460	FF-412	555	FG-67	52	FG-181	101
FF-72	460	FF-413	555	FG-68	52		
FF-73	460	FF-414	555	FG-69	52	FK-01	420
FF-74	460			FG-70	73	FK-1	53
FF-80	461	FG-1	44, 619	FG-71	73	FK-1TC	85
FF-81	461	FG-1SC	81	FG-72	73	FK-02	420
FF-82	461	FG-1TC	84	FG-73	63	FK-2	53
FF-83	461	FG-2	44, 619	FG-74	63	FK-2TC	85
FF-84	461	FG-2SC	81	FG-75	63	FK-03	420
FF-85	461	FG-2TC	84	FG-78	73	FK-04	420
FF-86	461	FG-3	46	FG-79	73	FK-05	420
FF-90	464	FG-4	44	FG-80	74	FK-06	420
FF-91	464	FG-5	44	FG-81	74	FK-07	420
FF-92	464	FG-6C	52	FG-82	74	FK-08	420
FF-102	462	FG-6R	52	FG-83	74	FK-09	500
FF-103	462	FG-7	71	FG-84	74	FK-10	53
FF-104	462	FG-8	71	FG-85	74	FK-11	414
FF-105	462	FG-9	71	FG-86	73	FK-12	395
FF-106	462	FG-10	68	FG-87	73	FK-13	414
FF-107	462	FG-11L	83	FG-88	69	FK-14	414
FF-108	462	FG-12L	83	FG-89	73	FK-15	404
FF-109	462	FG-13	44	FG-92	84	FK-16	404
FF-110	462	FG-14	61	FG-96	77	FK-17	404
FF-111	462	FG-15	44	FG-97	77	FK-18	404
FF-120	463	FG-16	57	FG-99	71	FK-19	404
FF-121	463	FG-17	57	FG-100	59	FK-20	389
FF-122	463	FG-18	57	FG-101	45	FK-21	421
FF-123	463	FG-19C	52	FG-102	45	FK-22	421
FF-124	463	FG-19R	52	FG-103	45	FK-23	421
FF-125	463	FG-20	50	FG-104	44	FK-24	421
FF-126	463	FG-21	47	FG-105	45	FK-25	421
FF-127	463	FG-22	47	FG-106	69	FK-26	421
FF-128	463	FG-23	45	FG-107	69	FK-27	389
FF-129	463	FG-24	45	FG-108	46	FK-28	389
FF-130	463	FG-25	48	FG-109	46	FK-30	389
FF-131	463	FG-26	48	FG-110	72, 476	FK-31	421
FF-132	463	FG-27	48	FG-111	476	FK-32	421
FF-133	463	FG-28	61	FG-116	58	FK-33	421
FF-134	463	FG-30	46	FG-117	57	FK-34	421
FF-135	463	FG-31	101	FG-119	46	FK-35	421
FF-136	463	FG-32	101	FG-123	47	FK-36	421
FF-137	463	FG-33	101	FG-124	47	FK-37	421
FF-138	463	FG-34	77	FG-125	68	FK-38	421
FF-139	463	FG-35	77	FG-126	68	FK-39	421
FF-140	463	FG-36	47	FG-127	68	FK-40	403
FF-141	463	FG-37	47	FG-128	68	FK-41	403
FF-142	463	FG-38	46	FG-129	78	FK-42	403
FF-143	463	FG-39	46	FG-131	48	FK-43	403
FF-144	463	FG-40	72, 476	FG-132	69	FK-44	403
FF-145	463	FG-41	70	FG-133	69	FK-45	389
FF-146	463	FG-42	70	FG-138	76	FK-46	389
FF-147	433	FG-43	59	FG-139	76	FK-47	394
FF-148	433	FG-44	59	FG-140	58	FK-48	389
FF-149	433	FG-47	57	FG-141	58	FK-49	389
FF-180	558	FG-48	57	FG-142	58	FK-51	390
FF-181	558	FG-49	57	FG-144	78	FK-52	390
FF-182	558	FG-50	51	FG-147	58	FK-53	390
FF-183	558	FG-51	51	FG-148	58	FK-54	391
FF-184	558	FG-52	51	FG-149	79	FK-55	391
FF-185	558	FG-53	51	FG-150	101	FK-56	393
FF-186	558	FG-54	51	FG-152	70	FK-57	394
FF-187	558	FG-55	51	FG-156	49	FK-58	392



Articolo	Pagina	Articolo	Pagina	Articolo	Pagina	Articolo	Pagina
FK-59	392	FK-138	418	FK-238	406	FL-81	441
FK-60	420	FK-139	418	FK-240	406	FL-82	441
FK-61	420	FK-140	424	FK-243	414	FL-83	441
FK-62	420	FK-141	424	FK-244	414	FL-84	444
FK-63	420	FK-142	424	FK-248	402	FL-85	444
FK-64	420	FK-143	424	FK-249	402	FL-86	444
FK-65	420	FK-144	424	FK-250	402	FL-87	444
FK-66	420	FK-145	424	FK-251	402	FL-88	444
FK-67	420	FK-147	424	FK-252	401	FL-89	444
FK-68	420	FK-148	424	FK-254	402	FL-90	444
FK-69	420	FK-149	424	FK-255	402	FL-91	441
FK-70	416	FK-150	424	FK-256	402	FL-92	441
FK-71	416	FK-151	424	FK-257	402	FL-93	441
FK-72	417	FK-152	424	FK-258	402	FL-94	437
FK-73	417	FK-153	424	FK-260	401	FL-95	437
FK-74	417	FK-154	424	FK-261	401	FL-96	437
FK-75	416	FK-155	424	FK-262	401	FL-97	437
FK-76	416	FK-156	407	FK-263	401	FL-98	437
FK-77	416	FK-157	407			FL-99	437
FK-78	416	FK-158	407	FL-01	429	FL-100	441
FK-79	417	FK-159	407	FL-02	429	FL-101	441
FK-80	401	FK-160	423	FL-03	435	FL-102	441
FK-81	392	FK-161	423	FL-04	435	FL-103	441
FK-82	401	FK-162	423	FL-05	435	FL-104	430
FK-83	416	FK-163	423	FL-06	432	FL-105	430
FK-84	416	FK-164	394	FL-09	429	FL-106	430
FK-85	413	FK-168	394	FL-09R	429	FL-107	431
FK-86	413	FK-169	394	FL-10M	429	FL-108	431
FK-87	53	FK-170	423	FL-11	429	FL-109	431
FK-88	53	FK-171	423	FL-11R	429	FL-110	441
FK-90	491	FK-172	423	FL-12	429	FL-111	432
FK-91	491	FK-173	423	FL-12R	429	FL-112	431
FK-92	491	FK-176	393	FL-13	435	FL-113	432
FK-93	393	FK-177	417	FL-14	435	FL-114	435
FK-94	413	FK-178	417	FL-15	435	FL-115	435
FK-95	413	FK-179	393	FL-16	437	FL-116	435
FK-96	411, 571	FK-180	423	FL-17	437	FL-117	441
FK-97	411, 571	FK-181	423	FL-18	437	FL-118	435
FK-98	411, 571	FK-182	423	FL-20	434	FL-119	441
FK-99	411, 571	FK-183	423	FL-21	434	FL-126	435
FK-100	492	FK-188	418	FL-22	434	FL-127	435
FK-101	492	FK-189	418	FL-23	435	FL-132	435
FK-102	492	FK-190	423	FL-24	435	FL-135	435
FK-103	492	FK-191	423	FL-29	437	FL-136	435
FK-104	492	FK-192	423	FL-30	434	FL-138	435
FK-105	493	FK-193	408	FL-31	434	FL-147	449
FK-106	493	FK-194	408	FL-32	437	FL-148	449
FK-107	493	FK-195	408	FL-33	434	FL-149	449
FK-108	493	FK-196	408	FL-34	437	FL-150	28, 491
FK-109	493	FK-197	422	FL-35	434	FL-151	28, 491
FK-110	419	FK-198	422	FL-36	437	FL-152	28, 491
FK-111	419	FK-200	426	FL-40	435	FL-153	28, 491
FK-112	419	FK-201	425	FL-41	437	FL-160	439
FK-113	419	FK-202	425	FL-42	437	FL-162	439
FK-114	419	FK-203	425	FL-43	437	FL-164	439
FK-115	419	FK-204	425	FL-44	437	FL-166	439
FK-116	419	FK-205	426	FL-45	437	FL-168	439
FK-119	412	FK-206	426	FL-46	437	FL-170	439
FK-120	419	FK-207	426	FL-47	437	FL-172	439
FK-121	419	FK-208	426	FL-48	437	FL-174	439
FK-122	419	FK-211	425	FL-49	437	FL-176	439
FK-123	419	FK-212	425	FL-53	437	FL-177	436
FK-124	419	FK-213	425	FL-54	437	FL-178	439
FK-125	419	FK-221	425	FL-58	437	FL-179	436
FK-126	419	FK-222	425	FL-59	440	FL-180	439
FK-130	422	FK-223	425	FL-60	440	FL-181	436
FK-131	422	FK-230	405	FL-61	440	FL-182	439
FK-132	422	FK-232	405	FL-62	440	FL-183	436
FK-136	418	FK-234	405	FL-63	441	FL-184	436
FK-137	418	FK-236	406	FL-64	441	FL-185	436





Articolo	Pagina	Articolo	Pagina	Articolo	Pagina	Articolo	Pagina
FL-186	436	FL-315	443	FM-16	75	FM-81	65
FL-187	436	FL-316	443	FM-17	75	FM-82	65
FL-188	436	FL-320	584	FM-18	75	FM-83	65
FL-189	436	FL-322	584	FM-19	75	FM-84	65
FL-190	445	FL-323	584	FM-20	76	FM-85	65
FL-191	445	FL-324	584	FM-21	76	FM-86	66
FL-192	445	FL-334	450	FM-22	76	FM-87	66
FL-193	445	FL-335	450	FM-23	76	FM-88	66
FL-194	445	FL-336	450	FM-24	64	FM-89	66
FL-198	425	FL-337	450	FM-24SC	82	FM-90	92
FL-210	446	FL-340	442	FM-25	64	FM-91	92
FL-211	446	FL-341	442	FM-25SC	82	FM-92	92
FL-212	446	FL-342	442	FM-26	77	FM-94	92
FL-213	446	FL-343	442	FM-27	55	FM-96	84, 92
FL-214	446	FL-344	442	FM-28	55	FM-97	92
FL-215	446	FL-345	442	FM-29	55	FM-98	92
FL-216	446	FL-346	442	FM-29L	83	FM-99	92
FL-220	446	FL-347	442	FM-29SC	82	FM-100	99
FL-221	446	FL-348	442	FM-30	55	FM-102	99
FL-222	446	FL-349	442	FM-30L	83	FM-104	99
FL-223	446	FL-350	442	FM-30SC	82	FM-109	59
FL-224	446	FL-351	442	FM-31	55	FM-110	67
FL-225	446	FL-352	442	FM-32	55	FM-111	67
FL-226	446	FL-353	442	FM-33	55	FM-112	62
FL-230	445	FL-354	442	FM-34	55	FM-113	62
FL-231	445	FL-355	442	FM-35	54	FM-114	62
FL-232	445	FL-356	442	FM-36	54	FM-115	62
FL-233	445	FL-357	442	FM-37	54	FM-116	62
FL-234	445	FL-359	442	FM-38	54	FM-117	62
FL-240	445	FL-360	442	FM-39	54	FM-118	85
FL-241	445	FL-361	442	FM-40	54	FM-119	85
FL-242	445	FL-362	442	FM-41	56	FM-120	61
FL-243	445	FL-401	583	FM-42	56	FM-121	61
FL-244	445	FL-402	583	FM-43	56	FM-122	61
FL-250	448	FL-403	583	FM-44	56	FM-130	94
FL-251	448	FL-404	583	FM-45	56	FM-131	94
FL-252	448	FL-405	583	FM-46	56	FM-132	94
FL-253	433	FL-410	583	FM-47	59	FM-133	94
FL-254	433	FL-411	583	FM-48	59	FM-134	95
FL-255	433	FL-412	583	FM-49	55	FM-135	95
FL-256	433			FM-50	86	FM-136	95
FL-257	433	FM-1	60	FM-51	86	FM-137	95
FL-258	433	FM-1F	60	FM-52	86	FM-139	96
FL-259	433	FM-1SC	81	FM-53	86	FM-140	96
FL-260	448	FM-2	60	FM-54	87	FM-141	96
FL-261	448	FM-2F	60	FM-55	87	FM-142	96
FL-262	448	FM-2SC	81	FM-56	87	FM-143	96
FL-263	438	FM-3	60	FM-57	87	FM-145	88
FL-264	438	FM-3F	60	FM-58	88	FM-146	88
FL-265	438	FM-3SC	81	FM-59	88	FM-147	88
FL-266	438	FM-4	60	FM-60	88	FM-148	86
FL-267	438	FM-4F	60	FM-61	88	FM-149	86
FL-268	438	FM-4SC	81	FM-62	55	FM-150	86
FL-269	438	FM-5	64	FM-63	55	FM-151	87
FL-270	448	FM-5SC	82	FM-65	55	FM-152	87
FL-272	446	FM-6	64	FM-66	89	FM-153	87
FL-280	447	FM-6SC	82	FM-67	89	FM-154	93
FL-281	447	FM-7	56	FM-68	89	FM-155	93
FL-282	447	FM-7L	83	FM-69	89	FM-156	93
FL-283	447	FM-8	56	FM-70	61	FM-157	93
FL-284	447	FM-8L	83	FM-71	61	FM-159	93
FL-285	447	FM-9	54	FM-72	56	FM-160	89
FL-307	443	FM-9L	83	FM-73	56	FM-161	89
FL-308	443	FM-10	54	FM-74	61	FM-162	89
FL-309	443	FM-10L	83	FM-75	61	FM-163	89
FL-310	443	FM-11	62	FM-76	67	FM-174	97
FL-311	443	FM-12	59	FM-77	67	FM-175	77
FL-312	443	FM-13	62	FM-78	67	FM-180	66
FL-313	443	FM-14	75	FM-79	67	FM-181	66
FL-314	443	FM-15	75	FM-80	65	FM-188	64



Articolo	Pagina	Articolo	Pagina	Articolo	Pagina	Articolo	Pagina
FM-189	64	FO-61	474	FO-161	472	GF-10	662
FM-190	98	FO-62	484	FO-162	453	GF-11	665
FM-191	98	FO-63	72, 476	FO-163	453	GF-12	662
FM-192	98	FO-64	480	FO-165	453	GF-13	660
FM-193	97	FO-65	483	FO-171	457	GF-14	660
FM-194	98	FO-66	480	FO-172	457	GF-15	660
FM-201	90	FO-67	479	FO-173	457	GF-16	660
FM-202	91	FO-68	480	FO-174	457	GF-17	660
FM-203	90	FO-69	479	FO-175	457	GF-18	660
FM-204	91	FO-71	483	FO-180	458	GF-19	675
FM-205	90	FO-72	483	FO-181	458	GF-20	666
FM-206	91	FO-73	483	FO-182	458	GF-21	671
FM-207	90	FO-74	483	FO-183	458	GF-22	675
FM-208	91	FO-75	483	FO-184	458	GF-23	675
FM-209	90	FO-76	478	FO-185	458	GF-24	671
FM-210	91	FO-78	479	FO-186	458	GF-25	671
FM-211	90	FO-79	480	FO-187	458	GF-26	671
FM-212	91	FO-80	488	FO-188	458	GF-27	671
FM-350	85	FO-81	480	FO-189	458	GF-28	671
		FO-82	484	FO-199	471	GF-29	675
FO-10	468	FO-84	484	FO-200	472	GF-30	659
FO-11	469	FO-85	466	FO-201	455	GF-31	659
FO-12	469	FO-87	466	FO-202	455	GF-32	659
FO-13	469	FO-88	466	FO-203	455	GF-33	659
FO-14	469	FO-89	466	FO-204	455	GF-34	659
FO-15	467	FO-90	487	FO-205	455	GF-35	659
FO-16	467	FO-91	487	FO-212	455	GF-36	665
FO-17	467	FO-92	487	FO-213	455	GF-37	665
FO-18	467	FO-93	479	FO-215	455	GF-38	665
FO-19	467	FO-94	479	FO-222	456	GF-39	665
FO-20	470	FO-96	487	FO-223	456	GF-40	679
FO-21	467	FO-100	454	FO-224	456	GF-41	674
FO-22	466	FO-101	454	FO-225	456	GF-42	674
FO-23	466	FO-102	454	FO-299	488	GF-43	670
FO-24	466	FO-103	454	FO-300	488	GF-44	665
FO-25	468	FO-104	454			GF-45	670
FO-27	468	FO-105	484	FR-15	395	GF-46	675
FO-28	470	FO-108	474	FR-18	572	GF-47	670
FO-29	470	FO-110	486	FREER	395	GF-48	667
FO-30	470	FO-112	486			GF-49	667
FO-31	470	FO-114	486	G-8	9	GF-50	667
FO-32	470	FO-115	486	G-10	9	GF-51	668
FO-33	468	FO-116	486	G-12	9	GF-52	668
FO-34	470	FO-117	454	G-14	9	GF-53	672
FO-35	470	FO-118	454	G-16	9	GF-54	662
FO-36	471	FO-119	454	G-18	9	GF-55	672
FO-37	469	FO-120	454	G-20	9	GF-56	672
FO-38	471	FO-121	454	G-22	9	GF-57	672
FO-39	469	FO-122	454	G-24	9	GF-58	672
FO-40	475	FO-123	454	G-26	9	GF-59	672
FO-41	473	FO-124	454	G-28	9	GF-60	674
FO-42	473	FO-125	456	G-30	9	GF-61	674
FO-43	468	FO-126	456			GF-62	681
FO-44	478	FO-127	456	GA-95	586	GF-63	670
FO-45	469	FO-128	456	GA-96	586	GF-64	681
FO-46	481	FO-129	456	GA-97	586	GF-65	670
FO-47	481	FO-130	485	GA-98	586	GF-66	681
FO-48	481	FO-131	485	GA-99	586	GF-67	670
FO-49	481	FO-133	485	GA-100	586	GF-69	674
FO-50	478	FO-134	485			GF-70	674
FO-51	478	FO-136	585	GF-01	665	GF-71	667
FO-52	478	FO-137	585	GF-02	665	GF-72	667
FO-53	478	FO-141	563	GF-03	665	GF-75	661
FO-54	478	FO-142	563	GF-04	665	GF-76	661
FO-55	482	FO-143	73, 564	GF-05	665	GF-77	661
FO-56	482	FO-144	564	GF-06	662	GF-78	661
FO-57	482	FO-146	474	GF-07	662	GF-80	673
FO-58	474	FO-158	475	GF-08	668	GF-81	673
FO-59	474	FO-159	488	GF-09	666	GF-82	673
FO-60	474	FO-160	472	GF-09B	666	GF-83	673



Articolo	Pagina	Articolo	Pagina	Articolo	Pagina	Articolo	Pagina
GF-84	673	GF-165	677	GS-09	697	KI-82	495
GF-85	678	GF-166	677	GS-10	696	KI-85	495
GF-86	678	GF-167	677	GS-11	696	KI-90	495
GF-87	678	GF-168	677	GS-16	35	KI-99	494
GF-88	678	GF-169	677	GS-18	35	KI-100	494
GF-89	684	GF-170	677	GS-20	23	KI-102	494
GF-90	684	GF-171	677	GS-21	23	KI-114	494
GF-92	676	GF-172	677	GS-22	23	KI-115	494
GF-93	676	GF-173	677	GS-23	23, 104	KI-116	494
GF-94	676	GF-174	677	GS-24	23, 104	KI-117	494
GF-96	676	GF-175	677	GS-25	23, 104	KI-118	494
GF-97	676	GF-176	677	GS-26	23, 104	KI-120	494
GF-98	666	GF-177	677	GS-27	23, 104	KI-122	494
GF-99	666	GF-178	677	GS-28	23, 104	KI-125	494
GF-100	678	GF-179	677	GS-29	23, 104	KI-130	494
GF-101	678	GF-180	679	GS-30	697	KI-160	496
GF-102	678	GF-184	679	GS-31	697	KI-161	496
GF-103	678	GF-188	679	GS-40	24	KI-175	497
GF-104	666	GF-189	679	GS-42	24	KI-176	497
GF-106	377	GF-190	680	GS-44	24	KI-177	497
GF-108	646	GF-191	680	GS-46	24	KI-178	497
GF-109	646	GF-192	680	GS-48	24	KI-179	497
GF-110	666	GF-193	663	GS-50	24	KI-180	497
GF-111	676	GF-194	663			KI-181	497
GF-112	676	GF-195	663	KI-00	494	KI-182	497
GF-113	676	GF-196	663	KI-01	494	KI-183	497
GF-114	664	GF-197	663	KI-02	494	KI-184	497
GF-115	664	GF-200	679	KI-10	516	KI-185	497
GF-116	664	GF-210	668	KI-14	494	KI-186	497
GF-117	664	GF-211	668	KI-15	494	KI-187	497
GF-118	675	GF-212	668	KI-16	494	KI-188	497
GF-119	675	GF-213	668	KI-17	494	KI-189	497
GF-120	374	GF-214	668	KI-18	494	KI-190	497
GF-121	374	GF-215	668	KI-20	494	KI-191	497
GF-122	374	GF-216	668	KI-22	494	KI-192	497
GF-123	374	GF-217	668	KI-25	494	KI-193	497
GF-124	663	GF-222	668	KI-30	494	KI-194	497
GF-125	663	GF-223	668	KI-40	494	KI-195	497
GF-126	663	GF-224	668	KI-41	494	KI-196	497
GF-127	663	GF-225	668	KI-42	494	KI-197	497
GF-128	663	GF-226	668	KI-43	494	KI-198	497
GF-129	663	GF-227	668	KI-44	494	KI-199	497
GF-135	646	GF-228	668	KI-45	494	KI-202	499
GF-136	646	GF-229	668	KI-46	494	KI-203	499
GF-137	646	GF-230	668	KI-47	494	KI-204	499
GF-138	646	GF-232	670	KI-48	494	KI-205	499
GF-139	646	GF-240	669	KI-49	494	KI-206	499
GF-140	669	GF-241	669	KI-50	496	KI-207	499
GF-141	669	GF-242	669	KI-51	496	KI-208	499
GF-142	669	GF-243	669	KI-52	496	KI-209	499
GF-143	669	GF-244	669	KI-53	496	KI-210	499
GF-144	669			KI-54	496	KI-211	499
GF-145	664	GFC	49	KI-55	496	KI-212	499
GF-146	664	GFC-S	45	KI-56	496	KI-220	495
GF-147	664	GFC-SC	80	KI-57	496	KI-221	495
GF-148	664	GFC-TC	84	KI-58	496	KI-222	495
GF-150	669	GFR	49	KI-60	495	KI-223	495
GF-151	669	GFR-S	45	KI-61	495	KI-230	498
GF-152	669	GFR-SC	80	KI-62	495	KI-231	498
GF-153	669	GFR-TC	84	KI-63	495	KI-232	498
GF-154	669	GFS	50	KI-64	495	KI-238	498
GF-156	677	GFS-SC	80	KI-69	495	KI-240	498
GF-157	677			KI-70	495	KI-242	498
GF-158	677	GS-01	697	KI-72	495	KI-244	498
GF-159	677	GS-02	696	KI-74	495	KI-246	498
GF-160	677	GS-03	696	KI-75	495	KI-248	498
GF-161	677	GS-04	696	KI-76	495	KI-252	496
GF-162	677	GS-05	697	KI-77	495	KI-254	496
GF-163	677	GS-06	696	KI-78	495	KI-256	496
GF-164	677	GS-07	697	KI-80	495	KI-258	496



Articolo	Pagina	Articolo	Pagina	Articolo	Pagina	Articolo	Pagina
KI-260	496	LB-12	33	LS-78	530	LS-311	528
KI-262	496	LB-12D	33	LS-80	524	LS-312	528
KI-264	496	LB-13	33	LS-81	524	LS-313	528
KI-280	496	LB-15	33	LS-82	524	LS-314	528
KI-282	496	LB-18	33	LS-83	524	LS-315	528
KI-284	496	LB-20	33	LS-84	524	LS-316	529
KI-286	496	LB-21	33	LS-85	524	LS-317	529
KI-288	496	LB-22	33	LS-90	525	LS-318	529
KI-290	496	LB-23	33	LS-91	525	LS-320	527
KI-293	498	LB-24	33	LS-92	525	LS-321	527
KI-294	498	LB-25	33	LS-93	525	LS-322	527
KI-295	498	LB-36	33	LS-94	518	LS-323	527
KI-296	498	LB-40	35	LS-95	518	LS-324	527
KI-297	498	LB-361	34	LS-96	518	LS-325	527
KI-298	498	LB-362	34	LS-97	518	LS-326	527
KI-300	497	LB-363	34	LS-98	518	LS-329	527
KI-301	497	LB-364	34	LS-100	500	LS-330	527
KI-306	500	LB-365	34	LS-101	530	LS-400	531
KI-307	500	LB-366	34	LS-102	530	LS-405	531
KI-308	500	LB-367	34	LS-103	530	LS-406	531
KI-322	499	LB-368	34	LS-104	530	LS-410	531
KI-330	498	LB-369	34	LS-106	500		
KI-331	498			LS-110	499	LX-80	507
KI-332	498	LG-1	50	LS-112	518	LX-82	510
KI-333	498	LG-1SC	80	LS-113	518	LX-92TC	510
KI-334	498	LG-2SC	80	LS-114	518	LX-95TC	510
KI-335	498	LG-6	50	LS-115	518	LX-96TC	510
KI-336	498			LS-116	526	LX-99	510
		LK-1	48	LS-117	526	LX-102	513
KO-1	381	LK-2	53	LS-119	526	LX-103	513
KO-2	381	LK-3	48	LS-120	523	LX-104	514
KO-11	565	LK-4	53	LS-121	526	LX-105	514
KO-12	565			LS-122	530	LX-106	514
KO-14	383	LS-06	22, 516	LS-123	530	LX-107	515
KO-15	383	LS-07	22, 516	LS-124	526	LX-108	473
KO-16	383	LS-08	22, 516	LS-125	522	LX-109	473
KO-17	383	LS-09	22, 516	LS-126	522	LX-110	473
KO-18	382	LS-10	519	LS-127	529	LX-112	475
KO-19	382	LS-11	519	LS-128	529	LX-113	532
KO-20	395	LS-12	519	LS-135	522	LX-114	532
KO-21	382	LS-13	519	LS-136	522	LX-115	532
KO-22	395	LS-14	519	LS-137	522	LX-120	533
KO-23	395	LS-15	519	LS-138	522	LX-121	533
KO-24	382	LS-16	519	LS-139	522	LX-122	533
KO-25	382	LS-17	519	LS-140	522	LX-123	533
KO-26	382	LS-20	520	LS-200	517	LX-125	512
KO-27	382	LS-21	520	LS-201	517	LX-130	509
KO-28	382	LS-22	520	LS-202	517	LX-131	509
KO-29	382	LS-23	520	LS-227	501	LX-134	508
KO-30	397	LS-24	520	LS-228	501	LX-135	508
KO-34	384	LS-25	520	LS-229	501	LX-136	508
KO-35	384	LS-26	520	LS-230	503	LX-137	508
KO-36	384	LS-27	520	LS-231	503	LX-138	509
KO-37	384	LS-28	520	LS-232	503	LX-139	509
KO-38	397	LS-29	520	LS-233	501	LX-140	509
KO-39	395	LS-30	520	LS-234	503	LX-141	509
KO-40	385	LS-32	519	LS-235	527	LX-160	477
KO-41	385	LS-33	519	LS-236	501, 502	LX-161	477
KO-42	385	LS-40	521	LS-237	502	LX-162	477
KO-43	385	LS-41	521	LS-238	502	LX-163	477
KO-44	385	LS-42	521	LS-239	502	LX-164	477
KO-46	397	LS-43	521	LS-240	523	LX-165	477
KO-47	383	LS-44	521	LS-241	501, 502	LX-166	477
KO-48	383	LS-45	521	LS-242	523		
KO-49	383	LS-46	521	LS-244	523	MA-6	9
KO-50	383	LS-47	521	LS-300	414	MA-B1	30
KO-60	289	LS-48	521	LS-301	414	MA-B2	30
		LS-49	521	LS-302	414	MA-B3	30
LB-10	33	LS-50	521	LS-303	414	MA-B3M	30
LB-11	33	LS-76	530	LS-310	528	MA-B3L	31



Articolo	Pagina	Articolo	Pagina	Articolo	Pagina	Articolo	Pagina
<b>MA-B4</b>	32	<b>MF-85</b>	615	<b>NK-18</b>	27, 590, 617	<b>NK-92</b>	599
<b>MA-B4L</b>	32	<b>MF-86</b>	615	<b>NK-19</b>	589	<b>NK-93</b>	589, 618, 620
<b>MA-B5</b>	31	<b>MF-87</b>	615	<b>NK-20</b>	27, 590	<b>NK-94</b>	592
<b>MA-B6</b>	32	<b>MF-88</b>	615	<b>NK-21</b>	591	<b>NK-95</b>	28
<b>MA-B7</b>	30	<b>MF-93</b>	107, 617	<b>NK-22</b>	591	<b>NK-96</b>	28
<b>MA-B7K</b>	30	<b>MF-94</b>	107, 617	<b>NK-23</b>	591, 617	<b>NK-97</b>	592, 618
<b>MA-B8</b>	30	<b>MF-97</b>	618	<b>NK-24</b>	591	<b>NK-98</b>	592
<b>MA-B9</b>	30	<b>MF-101</b>	123	<b>NK-25</b>	591	<b>NK-99</b>	592
<b>MA-B10</b>	32	<b>MF-102</b>	123	<b>NK-26</b>	591	<b>NK-100</b>	28
<b>MA-B11</b>	31	<b>MF-103</b>	123	<b>NK-27</b>	590	<b>NK-101</b>	28
<b>MA-B12</b>	31	<b>MF-104</b>	123	<b>NK-28</b>	590, 617	<b>NK-102</b>	28
<b>MA-B15</b>	31	<b>MF-105</b>	123	<b>NK-29</b>	590	<b>NK-105</b>	592
		<b>MF-110</b>	108	<b>NK-30</b>	27	<b>NK-107</b>	592
<b>MEAD</b>	395	<b>MF-111</b>	108	<b>NK-31</b>	29	<b>NK-108</b>	592
		<b>MF-112</b>	108	<b>NK-32</b>	27	<b>NK-109</b>	592
<b>MF-04</b>	107	<b>MF-113</b>	108	<b>NK-33</b>	29	<b>NK-110</b>	592, 620
<b>MF-13</b>	614	<b>MF-114</b>	108	<b>NK-34</b>	27	<b>NK-111</b>	592, 620
<b>MF-14</b>	614	<b>MF-115</b>	108	<b>NK-35</b>	29	<b>NK-112</b>	592
<b>MF-15</b>	614	<b>MF-124</b>	111	<b>NK-36</b>	27	<b>NK-131</b>	599
<b>MF-16</b>	614	<b>MF-125</b>	111	<b>NK-37</b>	29	<b>NK-398</b>	618
<b>MF-17</b>	614	<b>MF-126</b>	111	<b>NK-38</b>	27	<b>NK-401</b>	595
<b>MF-19</b>	614	<b>MF-127</b>	111	<b>NK-39</b>	589	<b>NK-403</b>	595
<b>MF-20</b>	614	<b>MF-128</b>	111	<b>NK-40</b>	27	<b>NK-420</b>	598
<b>MF-21</b>	614	<b>MF-129</b>	111	<b>NK-41</b>	590	<b>NK-421</b>	598
<b>MF-22</b>	614	<b>MF-142T</b>	111	<b>NK-42</b>	590	<b>NK-422</b>	598
<b>MF-23</b>	614	<b>MF-143T</b>	111	<b>NK-43</b>	590		
<b>MF-24</b>	614	<b>MF-144T</b>	111	<b>NK-44</b>	591	<b>OL-01</b>	378, 680
<b>MF-25</b>	614	<b>MF-145T</b>	111	<b>NK-45</b>	591, 620	<b>OL-02</b>	378, 680
<b>MF-26</b>	614	<b>MF-146T</b>	111	<b>NK-46</b>	591	<b>OL-03</b>	378, 680
<b>MF-27</b>	614	<b>MF-147T</b>	111	<b>NK-47</b>	591	<b>OL-04</b>	378, 680
<b>MF-28</b>	614	<b>MF-148</b>	111	<b>NK-48</b>	592, 618	<b>OL-05</b>	378, 680
<b>MF-29</b>	614	<b>MF-149</b>	111	<b>NK-49</b>	589	<b>OL-06</b>	682
<b>MF-30</b>	614	<b>MF-150</b>	596	<b>NK-50</b>	29	<b>OL-07</b>	682
<b>MF-31</b>	614	<b>MF-151</b>	596	<b>NK-51</b>	29	<b>OL-08</b>	682
<b>MF-32</b>	614	<b>MF-231</b>	596	<b>NK-52</b>	29	<b>OL-09</b>	682
<b>MF-33</b>	614	<b>MF-232</b>	596	<b>NK-53</b>	29	<b>OL-10</b>	682
<b>MF-34</b>	612, 619	<b>MF-245</b>	596	<b>NK-54</b>	29	<b>OL-11</b>	682
<b>MF-35</b>	612	<b>MF-246</b>	596	<b>NK-55</b>	29	<b>OL-13</b>	681
<b>MF-36</b>	612	<b>MF-278</b>	596	<b>NK-56</b>	29	<b>OL-14</b>	681
<b>MF-37</b>	612	<b>MF-279</b>	596	<b>NK-57</b>	29	<b>OL-15</b>	681
<b>MF-38</b>	612	<b>MF-320</b>	132	<b>NK-59</b>	592, 620	<b>OL-16</b>	681
<b>MF-40</b>	612, 619			<b>NK-60</b>	594, 617	<b>OL-17</b>	681
<b>MF-41</b>	612	<b>MO-15</b>	401	<b>NK-61</b>	594	<b>OL-18</b>	681
<b>MF-42</b>	612			<b>NK-62</b>	594	<b>OL-19</b>	682
<b>MF-43</b>	612	<b>MP-201</b>	617	<b>NK-63</b>	594	<b>OL-20</b>	593, 618
<b>MF-44</b>	612	<b>MP-203</b>	618	<b>NK-64</b>	594	<b>OL-22</b>	681
<b>MF-46</b>	613	<b>MP-204</b>	618	<b>NK-65</b>	594	<b>OL-23</b>	681
<b>MF-47</b>	613	<b>MP-206</b>	618	<b>NK-66</b>	594	<b>OL-24</b>	681
<b>MF-48</b>	613	<b>MP-207</b>	619	<b>NK-67</b>	594	<b>OL-25</b>	682
<b>MF-49</b>	613	<b>MP-208</b>	619	<b>NK-69</b>	594, 619	<b>OL-26</b>	682
<b>MF-50</b>	613	<b>MP-209</b>	620	<b>NK-70</b>	594	<b>OL-27</b>	682
<b>MF-52</b>	613	<b>MP-210</b>	617	<b>NK-71</b>	594	<b>OL-28</b>	682
<b>MF-53</b>	613			<b>NK-73</b>	594	<b>OL-29</b>	682
<b>MF-54</b>	613	<b>NK-1</b>	34	<b>NK-74</b>	589, 618	<b>OL-30</b>	228, 681
<b>MF-55</b>	613	<b>NK-2</b>	34	<b>NK-75</b>	591, 618	<b>OL-31</b>	228, 681
<b>MF-56</b>	613	<b>NK-03</b>	591	<b>NK-76</b>	589	<b>OL-32</b>	228, 681
<b>MF-58</b>	617	<b>NK-04</b>	591	<b>NK-77</b>	594	<b>OL-33</b>	228, 681
<b>MF-64</b>	617	<b>NK-05</b>	592	<b>NK-78</b>	594	<b>OL-34</b>	682
<b>MF-73</b>	613	<b>NK-06</b>	27, 589	<b>NK-79</b>	598, 618	<b>OL-36</b>	682
<b>MF-74</b>	613	<b>NK-07</b>	589	<b>NK-80</b>	598, 617	<b>OL-37</b>	682
<b>MF-75</b>	613	<b>NK-08</b>	27, 589	<b>NK-82</b>	598	<b>OL-38</b>	682
<b>MF-76</b>	613	<b>NK-09</b>	589, 618	<b>NK-83</b>	598	<b>OL-39</b>	682
<b>MF-77</b>	616, 617	<b>NK-10</b>	27, 589, 620	<b>NK-84</b>	598, 620	<b>OL-40</b>	377
<b>MF-78</b>	616	<b>NK-11</b>	590	<b>NK-85</b>	35	<b>OL-41</b>	378, 684
<b>MF-79</b>	616, 617, 619	<b>NK-12</b>	35, 617, 620	<b>NK-86</b>	598	<b>OL-42</b>	378, 684
<b>MF-80</b>	616, 619	<b>NK-13</b>	590	<b>NK-87</b>	594	<b>OL-43</b>	378, 684
<b>MF-81</b>	107, 616	<b>NK-14</b>	27, 590	<b>NK-88</b>	594	<b>OL-44</b>	378, 684
<b>MF-82</b>	107, 616	<b>NK-15</b>	589	<b>NK-89</b>	594	<b>OL-45</b>	378, 684
<b>MF-83</b>	616	<b>NK-16</b>	27, 590	<b>NK-90</b>	28	<b>OL-46</b>	378, 684
<b>MF-84</b>	616	<b>NK-17</b>	589	<b>NK-91</b>	28	<b>OL-47</b>	378, 684



Articolo	Pagina	Articolo	Pagina	Articolo	Pagina	Articolo	Pagina
OL-48	378, 684	OM-52	290, 539	OR-40	22	P-66	158
OL-49	378, 684	OM-55	539	OR-42	22	P-67	158
OL-50	593, 620	OM-58	539			P-68	150
OL-51	593, 620	OM-60	6, 537	P-00	9	P-69	150
OL-52	593, 620	OM-62	6, 537	P-0	9	P-70	157
OL-53	593, 618, 620	OM-74	538	P-01	9	P-71	157
OL-54	593	OM-75	538	P-02	9	P-72	157
OL-55	593	OM-76	538	P-03	9	P-73	157
OL-56	593	OM-77	538	P-04	9	P-74	157
OL-57	593	OM-80	325, 543	P-05	9	P-75	157
OL-58	593	OM-81	325, 543	P-06	9	P-76	157
OL-63	682	OM-82	325, 543	P-07	174	P-77	157
OL-64	682	OM-85	325	P-08	139	P-78	157
OL-66	680	OM-87	325, 543	P-09	139	P-79	155
OL-67	680	OM-88	325, 543	P-10	168	P-81	151
OL-68	680	OM-90	538	P-11	168	P-82	151
OL-69	680	OM-92	538	P-12	166	P-84	155
OL-86	683	OM-98	543	P-13	166	P-85	155
OL-87	683	OM-99	326	P-14	166	P-86	151
OL-88	683	OM-100	543	P-15	160	P-87	151
OL-89	683	OM-101	326	P-16	151	P-89	155
OL-90	683	OM-102	326	P-17	150	P-91	150, 620
OL-91	683	OM-103	326	P-18	154	P-92	150
OL-92	683	OM-104	326	P-19	154	P-93	150
OL-93	683	OM-105	326	P-20	156	P-94	150
OL-94	683	OM-110	542	P-21	156	P-95	149
OL-95	683	OM-111	542	P-22	156	P-96	149
OL-96	683	OM-112	542	P-23	156	P-97	149
OL-97	683	OM-113	542	P-24	156	P-98	149
OL-98	683	OM-114	542	P-25	156	P-99	145, 629
OL-99	683	OM-136	6, 540	P-26	156	P-100	145
		OM-137	6, 540	P-27	156	P-101	149
OM-04	4	OM-138	6, 540	P-28	154	P-102	149
OM-05	4	OM-139	6, 540	P-29	154	P-103	144
OM-06	544	OM-140	541	P-30	156	P-104	158
OM-07	4	OM-141	541	P-31	156	P-111	620
OM-08	544	OM-142	541	P-32	156	P-113	144
OM-10	7, 143	OM-143	541	P-33	156	P-114	144
OM-11	7, 143	OM-144	541	P-34	156	P-115	145
OM-12	7	OM-145	541	P-35	156	P-118	145
OM-13	7	OM-146	541	P-36	156	P-119	145
OM-14	7	OM-160	540	P-37	156	P-120	149
OM-15	7	OM-161	540	P-38	154	P-121	149
OM-16	4	OM-162	540	P-39	154	P-122	151
OM-17	4	OM-163	540	P-40	157	P-123	164
OM-18	4	OM-164	540	P-41	157	P-125	164
OM-19	4	OM-170	541	P-42	157	P-127	168
OM-20	560	OM-171	541	P-43	157	P-128	168
OM-22	560	OM-172	541	P-44	157	P-130	166
OM-23	560	OM-173	541	P-45	157	P-131	166
OM-24	560	OM-174	541	P-46	157	P-132	145
OM-25	559	OM-201	326	P-47	157	P-133	145
OM-26	560	OM-202	326	P-48	157	P-134	145
OM-27	559	OM-203	326	P-49	155	P-135	149
OM-28	559	OM-204	326	P-50	145	P-136	160
OM-29	559	OM-208	326	P-51	145	P-137	160
OM-30	7, 143	OM-209	326	P-52	223	P-138	160
OM-32	561	OM-210	326	P-53	145	P-139	160
OM-34	561	OM-211	326	P-54	155	P-140	166
OM-36	561			P-55	155	P-141	166
OM-38	561	OR-11	19	P-56	154	P-142	161
OM-39	559	OR-12	20	P-57	154	P-143	161
OM-40	6, 537	OR-13	19	P-58	154	P-144	161
OM-41	6, 537	OR-14	20	P-59	154	P-145	161
OM-42	537	OR-15	19	P-60	139	P-146	161
OM-44	8, 143	OR-16	21	P-61	151	P-147	161
OM-45	8, 143	OR-17	19	P-62	151	P-148	161
OM-46	8, 143	OR-18	21	P-63	151	P-149	161
OM-47	8, 143	OR-19	19	P-64	151	P-150	161
OM-50	290, 539	OR-25	22	P-65	158		



Articolo	Pagina	Articolo	Pagina	Articolo	Pagina	Articolo	Pagina
P-151	167	P-221	154	PF-38	276	PH-71	250
P-152	167	P-222	165	PF-39	277	PH-72	251
P-153	167	P-223	165	PF-40	277	PH-73	250
P-154	167	P-224	629	PF-41	277	PH-74	244
P-155	167	P-225	629	PF-42	277	PH-75	251
P-156	167	P-226	629	PF-43	277	PH-76	251
P-157	161	P-227	168	PF-44	276	PH-77	252
P-158	161	P-228	168	PF-46	277	PH-78	244
P-159	161	P-229	168	PF-48	277	PH-79	254
P-160	161	P-230	152	PF-49	277	PH-80	258
P-161	161	P-231	152	PF-50	277	PH-81	258
P-162	161	P-232	152	PF-51	277	PH-82	258
P-163	161	P-233	152	PF-52	277	PH-83	258
P-164	161	P-234	152	PF-53	275	PH-84	258
P-165	161	P-235	152	PF-54	275	PH-85	254
P-166	161	P-236	152	PF-55	275	PH-86	256
P-167	161	P-237	152	PF-56	275	PH-87	256
P-168	161	P-238	152	PF-57	275	PH-88	256
P-169	161	P-239	152	PF-58	275	PH-89	256
P-170	160	P-240	152	PF-59	275	PH-91	257
P-171	160	P-241	152	PF-60	278	PH-93	257
P-172	160	P-242	152	PF-61	278	PH-94	257
P-173	160	P-243	152	PF-62	277	PH-95	256
P-174	163	P-244	152	PF-63	277	PH-96	256
P-175	163	P-245	152	PF-64	277	PH-97	256
P-176	163	P-246	155	PF-65	278	PH-98	256
P-177	163	P-247	155	PF-66	277	PH-101	255
P-178	163	P-248	158	PF-67	277	PH-102	255
P-179	164	P-249	158	PF-68	277	PH-103	255
P-180	164	P-250	153	PF-69	277	PH-104	255
P-181	164	P-251	153	PF-70	279	PH-106	254
P-182	223	P-252	153	PF-71	279	PH-107	254
P-183	223	P-253	153	PF-72	279	PH-108	254
P-184	223	P-254	153	PF-73	278	PH-110	255
P-185	223	P-255	153	PF-80	275	PH-111	255
P-186	223	P-256	153	PF-81	275	PH-112	255
P-187	223	P-257	153	PF-82	275	PH-113	255
P-188	223	P-258	153	PF-83	275	PH-114	255
P-189	163	P-259	153	PF-85	275	PH-117	251
P-190	163	P-260	153	PF-88	278	PH-118	251
P-191	162	P-261	153			PH-119	251
P-192	162	P-262	153	PH-38	243	PH-120	251
P-193	162	P-263	153	PH-39	243	PH-121	251
P-194	162			PH-40	244	PH-122	251
P-195	162	PF-7	276	PH-41	244	PH-123	251
P-196	162	PF-10	277	PH-42	244	PH-124	251
P-197	162	PF-13	277	PH-43	244	PH-125	251
P-198	165	PF-14	276	PH-44	244	PH-127	252
P-199	165	PF-15	276	PH-45	244	PH-128	252
P-200	158	PF-17	275	PH-46	245	PH-129	252
P-201	159	PF-18	275	PH-47	245	PH-130	252
P-202	159	PF-19	275	PH-48	243	PH-131	252
P-203	159	PF-20	276	PH-49	245	PH-132	254
P-204	159	PF-21	276	PH-52	244	PH-133	254
P-205	159	PF-22	276	PH-53	250	PH-134	254
P-206	159	PF-23	276	PH-54	250		
P-207	144	PF-24	275	PH-55	511	PO-37	247
P-208	158	PF-25	276	PH-56	511	PO-38	247
P-209	158	PF-26	276	PH-57	511	PO-40	249
P-210	162	PF-27	276	PH-58	252, 511	PO-46	249
P-211	159	PF-28	276	PH-59	251	PO-47	249
P-212	159	PF-29	276	PH-61	243	PO-48	249
P-213	159	PF-30	276	PH-62	243	PO-50	260
P-214	159	PF-31	276	PH-63	243	PO-51	260
P-215	162	PF-32	276	PH-64	243	PO-52	260
P-216	162	PF-33	276	PH-65	250	PO-55	261
P-217	162	PF-34	276	PH-66	250	PO-56	261
P-218	171	PF-35	276	PH-68	250	PO-59	247
P-219	171	PF-36	276	PH-69	250	PO-60	248
P-220	174	PF-37	276	PH-70	244	PO-65	248



Articolo	Pagina	Articolo	Pagina	Articolo	Pagina	Articolo	Pagina
<b>PO-66</b>	260	<b>TR-44</b>	373				
<b>PO-67</b>	249	<b>TR-45</b>	373				
<b>PO-71</b>	248	<b>TR-46</b>	373				
<b>PO-74</b>	249	<b>TR-47</b>	376				
<b>PO-75</b>	249	<b>TR-48</b>	376				
<b>PO-78</b>	248	<b>TR-49</b>	376				
<b>PO-79</b>	248	<b>TR-50</b>	376				
<b>PO-80</b>	248	<b>TR-51</b>	373				
<b>PO-81</b>	248	<b>TR-52</b>	373				
<b>PO-82</b>	260	<b>TR-53</b>	373				
<b>PO-83</b>	260	<b>TR-54</b>	373				
<b>PO-84</b>	260	<b>TR-55</b>	373				
<b>PO-85</b>	261	<b>TR-56</b>	373				
<b>PO-86</b>	261	<b>TR-57</b>	373				
<b>PO-87</b>	261	<b>TR-61</b>	374				
<b>PO-88</b>	249	<b>TR-62</b>	374				
<b>PO-89</b>	247	<b>TR-63</b>	374				
<b>PO-90</b>	248	<b>TR-64</b>	374				
<b>PO-91</b>	248	<b>TR-68</b>	377				
<b>PO-92</b>	260	<b>TR-69</b>	377				
<b>PO-94</b>	249	<b>TR-76</b>	490				
<b>PO-97</b>	253	<b>TR-77</b>	490				
<b>PO-99</b>	253	<b>TR-78</b>	490				
<b>PO-110</b>	260						
<b>PO-120</b>	259	<b>TS-50</b>	676				
<b>PO-121</b>	259	<b>TS-101</b>	695				
<b>PO-122</b>	259	<b>TS-102</b>	695				
<b>PO-123</b>	259	<b>TS-103</b>	695				
<b>PO-124</b>	259	<b>TS-104</b>	695				
<b>PO-125</b>	259						
<b>PO-126</b>	259	<b>VF-98</b>	515				
<b>PO-127</b>	259	<b>VF-98M</b>	515				
<b>PO-128</b>	259	<b>VH-20</b>	507				
<b>PO-129</b>	259	<b>VH-21</b>	507				
		<b>VH-23</b>	507				
<b>SC-1</b>	100	<b>VH-25</b>	507				
<b>SC-2</b>	100	<b>VH-40</b>	512				
<b>SC-5</b>	100						
<b>SC-10</b>	100	<b>VPC-6</b>	691				
<b>SC-12</b>	100	<b>VPC-8</b>	691				
		<b>VPC-10</b>	691				
<b>SL-1</b>	415	<b>VPC-12</b>	691				
<b>SL-2</b>	415						
		<b>VS-20</b>	693				
<b>TG-10</b>	434	<b>VS-26</b>	693				
<b>TG-11</b>	434	<b>VS-30</b>	693				
<b>TG-12</b>	434						
<b>TG-20</b>	434	<b>WEST</b>	395				
<b>TG-21</b>	434	<b>WG-10</b>	381				
<b>TG-22</b>	434	<b>WG-12</b>	381				
<b>TG-23</b>	434	<b>WG-14</b>	381				
<b>TG-40</b>	434						
<b>TG-41</b>	434						
<b>TR-20</b>	373						
<b>TR-21</b>	373						
<b>TR-22</b>	373						
<b>TR-23</b>	373						
<b>TR-24</b>	373						
<b>TR-25</b>	373						
<b>TR-26</b>	373						
<b>TR-30</b>	375						
<b>TR-32</b>	375						
<b>TR-33</b>	375						
<b>TR-34</b>	375						
<b>TR-35</b>	375						
<b>TR-40</b>	373						
<b>TR-41</b>	373						
<b>TR-42</b>	373						
<b>TR-43</b>	373						





**Bmed**  
Chirurgische Instrumente

 **BIOCABLAN**  
☎ 932 131 343

**BMED**  
CHIRURGISCHE INSTRUMENTE

**biocablan.com**

**Oficina Barcelona**  
c/ de la riera Mariona 4 local 3  
Molins de Rei - 08750  
Barcelona - España  
Tlf. +34 93 213 13 43  
Fax: +34 93 219 09 28

**Oficina Madrid**  
C/ Abad Juan Catalán, 12  
28032 Madrid - España  
Tlf. +34 91 053 16 20  
info@biocablan.com