



BONTEMPI[®]

CHIRURGISCHE INSTRUMENTE



plastische chirurgie
plastic surgery

Plastische Chirurgie
Plastic Surgery
Chirurgia Plastica

Cirugía Plástica
Chirurgie Plastique

1

Diagnostik, Meßinstrumente, Skalpelle
Diagnostic, Measuring Instruments, Knives
Diagnostica, Strumenti per misura, Bisturi
Diagnostico, Instrumentos para medir, Bisturí
Diagnostic, Instruments à mesurer, Bistouris

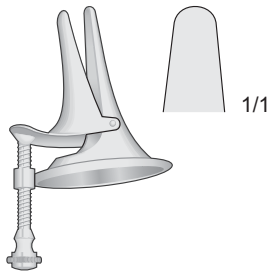

**DUPLAY
AB-41R**
Nasenspekulum
Nasal specula
Speculum nasale
Especulo nasales
Spèculum nasal

Speculum in Nylon
Schwarz - Black - Nero
Negro - Noir

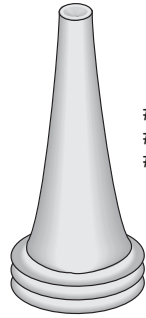

1 - Ø 3,0 mm
2 - Ø 4,5 mm
3 - Ø 5,5 mm

AB-32R
Satz zu 3
Set of 3
Set 3 pezzi
Jeugo de 3
Jeu de 3
Fig. 1-3

Spekulum für Erwachsene
Specula for adults
Speculum per adulti
Especula para adultos
Spèculum pour adultes

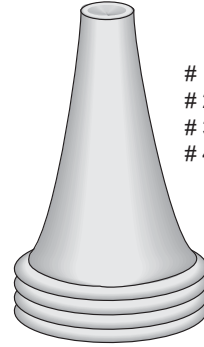

1 - **AB-04** - Ø 4,5 mm
2 - **AB-05** - Ø 5,5 mm
3 - **AB-06** - Ø 6,5 mm
4 - **AB-07** - Ø 7,5 mm

**HARTMANN
AB-09**
Satz zu 4
Set of 4
Set 4 pezzi
Jeugo de 4
Jeu de 4
Fig. 1-4

Laryngoskope - Laryngoscopes
Laringoscopi - Laringoscopios - Laryngoscopes

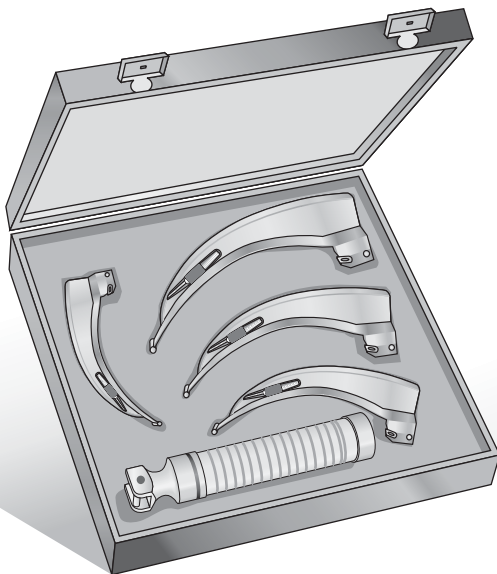

Mc INTOSH
AA-S104 - Set 4 lame

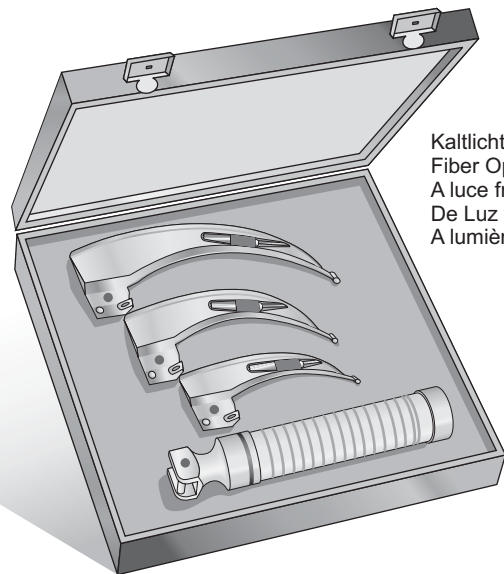

Mc INTOSH
AA-S503 - Set 3 lame

Kaltlicht
Fiber Optic
A luce fredda
De Luz fria
A lumière froide

Meßbereich: 0 - 15 mm
Measuring range: 0 - 15 mm
Campo di misura: 0 - 15 mm
Alcance de medición: 0 - 15 mm
Etendue de mesure: 0 - 15 mm

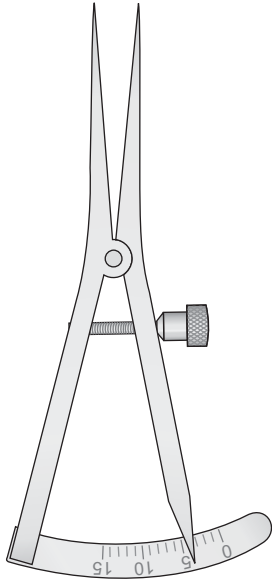

CASTROVIEJO
OR-15
90 mm

Meßbereich: 0 - 20 mm
Measuring range: 0 - 20 mm
Campo di misura: 0 - 20 mm
Alcance de medición: 0 - 20 mm
Etendue de mesure: 0 - 20 mm

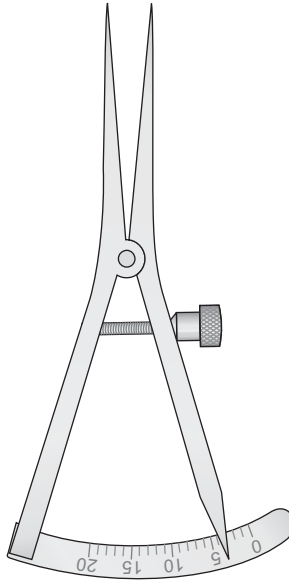

CASTROVIEJO
OR-17
90 mm

Meßbereich: 0 - 20 mm
Measuring range: 0 - 20 mm
Campo di misura: 0 - 20 mm
Alcance de medición: 0 - 20 mm
Etendue de mesure: 0 - 20 mm

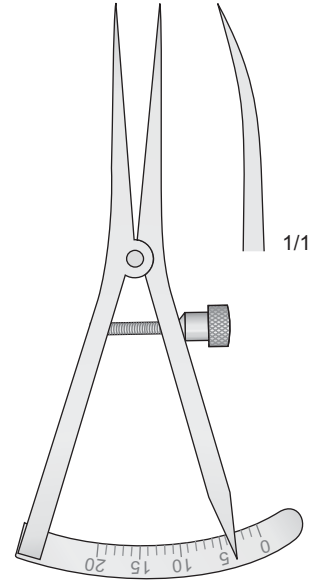

CASTROVIEJO
OR-19
90 mm

Meßbereich: 0 - 40 mm
Measuring range: 0 - 40 mm
Campo di misura: 0 - 40 mm
Alcance de medición: 0 - 40 mm
Etendue de mesure: 0 - 40 mm

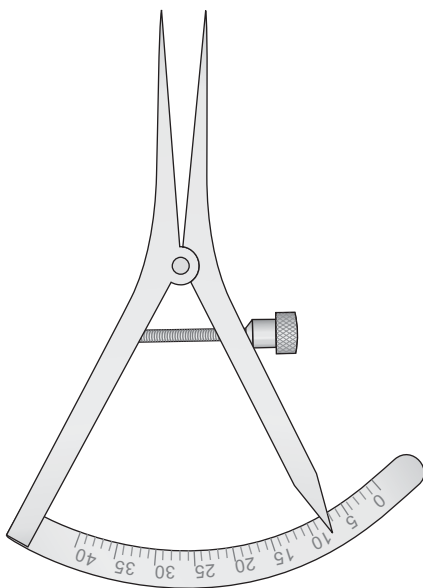

CASTROVIEJO
OR-11
90 mm

Meßbereich: 0 - 40 mm
Measuring range: 0 - 40 mm
Campo di misura: 0 - 40 mm
Alcance de medición: 0 - 40 mm
Etendue de mesure: 0 - 40 mm

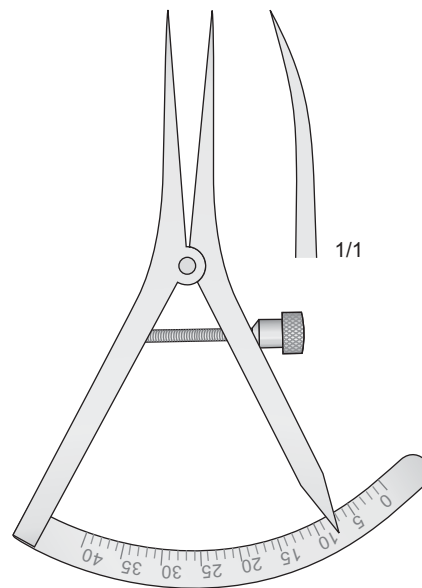

CASTROVIEJO
OR-13
90 mm

Meßbereich: 0 - 80 mm
Measuring range: 0 - 80 mm
Campo di misura: 0 - 80 mm
Alcance de medición: 0 - 80 mm
Etendue de mesure: 0 - 80 mm

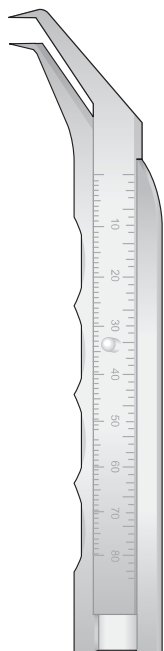

OR-40
125 mm

Meßbereich: 0 - 80 mm
Measuring range: 0 - 80 mm
Campo di misura: 0 - 80 mm
Alcance de medición: 0 - 80 mm
Etendue de mesure: 0 - 80 mm

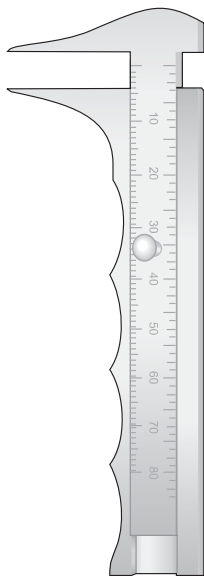

OR-45
95 mm



LS-04
80 mm

0,5 mm



LS-07
50 mm

0,5 mm



LS-08
120 mm

0,5 mm



LS-09
150 mm

0,5 mm



LS-06
300 mm

Skalpellgriffe

Scalpel handles

Manici per bisturi

Mangos de bisturi

Manches de bistouris

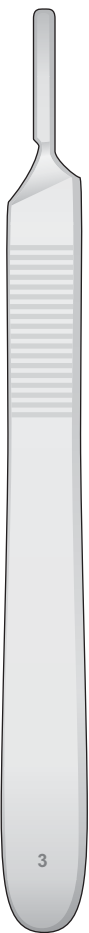
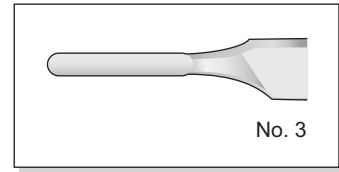

MA-B3
Fig. 3



MA-B3M
Fig. 3M



MA-B7
Fig. 7



MA-B7K
Fig. 7k



MA-B1
Fig. 5

Skalpеллgriffe
Skalpеллklingen, steril

Scalpel handles
Scalpel blades, sterile

Manici per bisturi
Lame da bisturi sterili

Mangos de bisturí
Hojas de bisturí
estériles

Manches de bistouris
Lames de bistouris
stériles

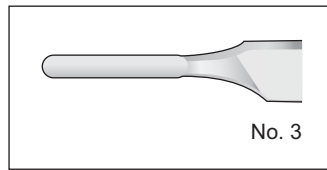

1,5 mm

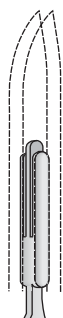

MA-B8

2,5 mm



MA-B9



LB-10
Fig. 10



LB-11
Fig. 11



LB-12
Fig. 12



LB-13
Fig. 13



LB-15
Fig. 15

Packung mit 100 Stück
Package with 100 units
Scatola da 100 pezzi
Paquete con 100 unidades
Boîte avec 100 lames



MA-B2
Fig. 5a



MA-B8/MA-B9
155 mm

Skalpellgriffe
Skalpellklingen, steril

Scalpel handles
Scalpel blades, sterile

Manici per bisturi
Lame da bisturi sterili

Mangos de bisturí
Hojas de bisturí
estériles

Manches de bistouris
Lames de bistouris
stériles

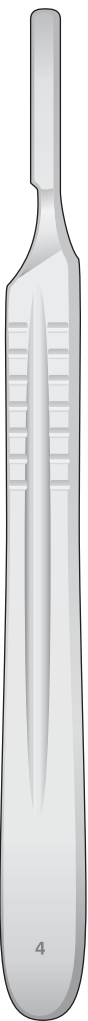
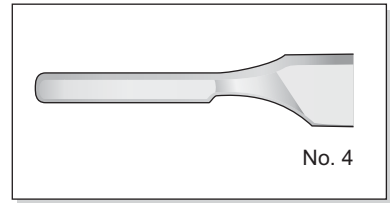

MA-B4
Fig. 4

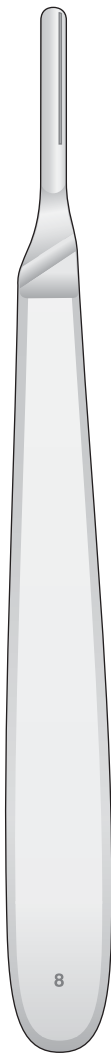

MA-B10
Fig. 8

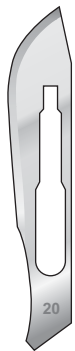

LB-20
Fig. 20



LB-21
Fig. 21



LB-22
Fig. 22



LB-23
Fig. 23



LB-25
Fig. 25

Packung mit 100 Stück
Package with 100 units
Scatola da 100 pezzi
Paquete con 100 unidades
Boîte avec 100 lames

Mikro-Skalpellklingen,
Skalpellgriffe

Micro Scalpel Blades,
Scalpel handles

Micro lame per bisturi,
Manici per bisturi

Micro hojas de bisturí,
Mangos de bisturí

Micro lame de bistouris,
Manches pour bistouris



LB-361



LB-362



LB-364



LB-365



LB-367



LB-368

Packung mit 10 Stück
Package with 10 units
Confezione 10 pezzi
Paquete con 10 unidades
Boîte avec 10 lames



LB-363

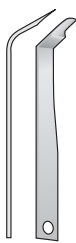

LB-366



LB-369

Packung mit 1 Stück
Package with 1 unit
Confezione 1 pezzo
Paquete con 1 unidade
Boîte avec 1 lame

Für Mikro-Skalpellklingen - For Micro Scalpel Blades
Per Micro Lame - Para Micro Hojas
Pour Micro-Lame de bistouris



NK-1
100 mm



NK-2
150 mm



BB-36
125 mm



BB-46
135 mm



BB-48 - 155 mm
BB-50 - 180 mm
BB-52 - 200 mm



CASPAR
BB-50



BB-52

1/1

1/1

Rasierklingen
Klingenbrecher

Razor Blades
Blade removing forceps

Lamette da rasoio
Pinze per rimozione lame

Hojas de afeitár
Pinza para quitar hojas

Lames de rasoir
Pincés pour enlever
les lames

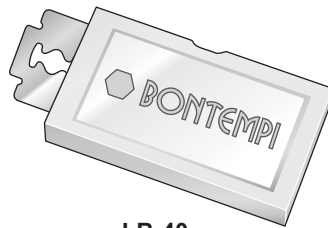

LB-40

Packung 10 Klingen
Package 10 blades
Scatola da 10 lame
Cajita de 10 hojas
Boite de 10 lames

Klingen-Entferner - Blade Remover
Per rimozione lame - Saca-Hojas
Enlève-Lames

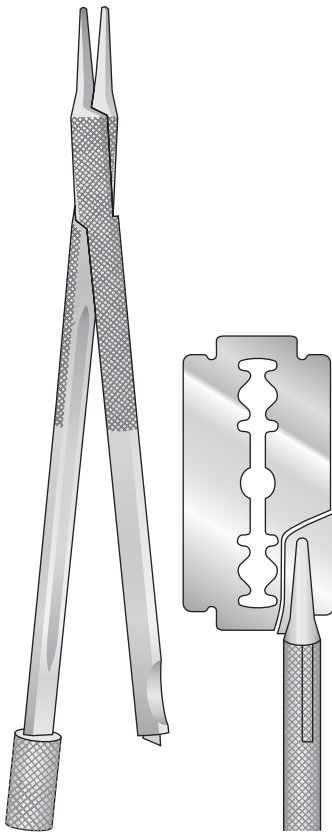

NK-12
120 mm

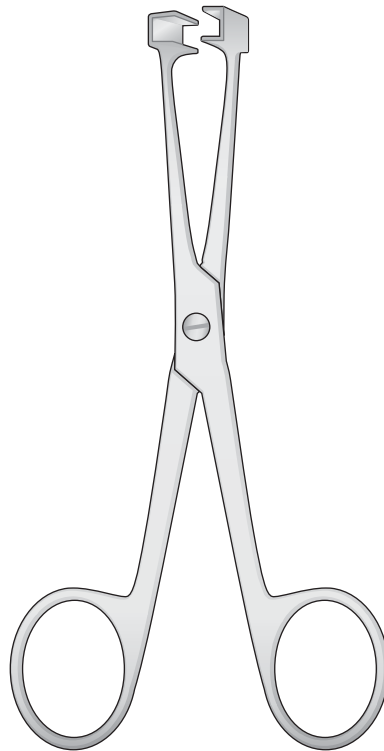

GS-18
135 mm

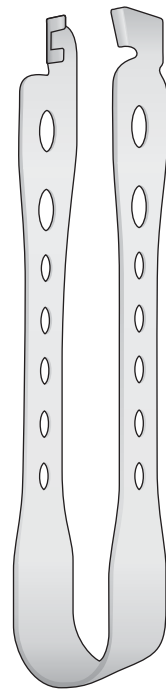

GS-16
115 mm

Rhinoplastikmesser

Rhinoplasty Knives

Bisturi per rinoplastica

Cuchillos para rinoplastica

Couteaux pour Rhino-plastie

Spitz
Sharp
Acuto - Agudas
Pointu



JOSEPH
NK-430/NK-431

Gerade
Straight
Diritto - Recto
Droit



NK-430
150 mm

Gebogen
Curved
Curvo - Curvo
Courbe



NK-431
150 mm

Stumpf
Blunt
Smussa - Romas
Mousse



JOSEPH
NK-432/NK-433

Gerade
Straight
Diritto - Recto
Droit



NK-432
150 mm

Gebogen
Curved
Curvo - Curvo
Courbe



NK-433
150 mm



JOSEPH
NK-100
150 mm

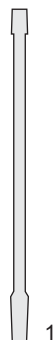

1/1



CONVERSE
NK-101
160 mm

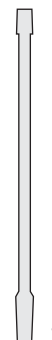

1/1



FOMON
NK-102
160 mm

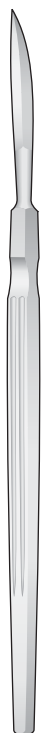

FOMON
FR-176
160 mm



1/1

1/1



COTTLE
FR-12
150 mm



COTTLE
FR-48
150 mm

Rhinoplastikmesser

Rhinoplasty Knives

Bisturi per rinoplastica

Cuchillos para rinoplastica

Couteaux pour Rhino-plastie



**FREER
FR-11**
175 mm

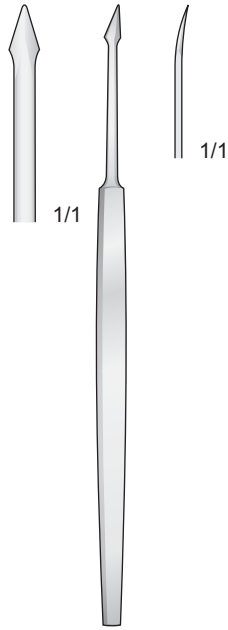

**MASING
FR-168**
130 mm

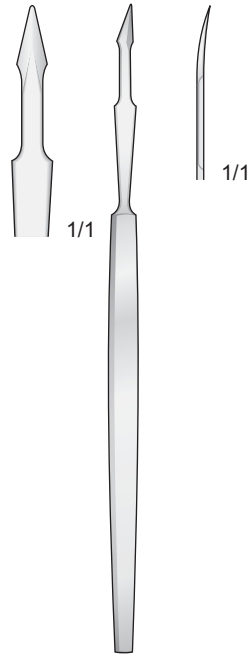

**MASING
FR-169**
130 mm

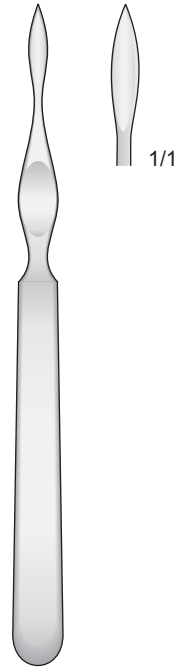

**BALLENGER
FR-175**
140 mm



**FREER
FR-18**
165 mm



**BRÜNINGS
FR-177**
165 mm

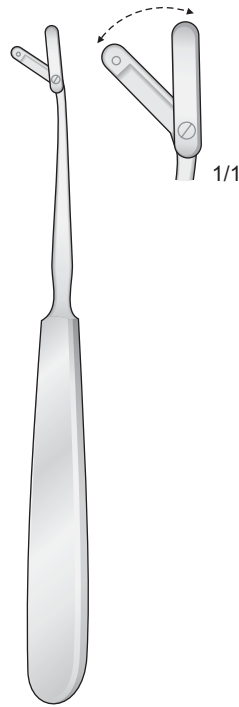

**MALTZ
FR-19**
160 mm

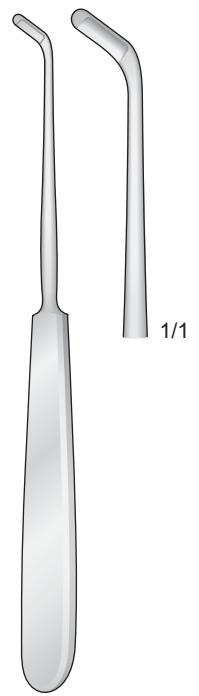

**JOSEPH
FR-49**
160 mm



2

Scheren
Scissors
Forbici
Tijeras
Ciseaux

Mikro Scheren

Micro scissors

Micro forbici

Micro tijeras

Micro ciseaux

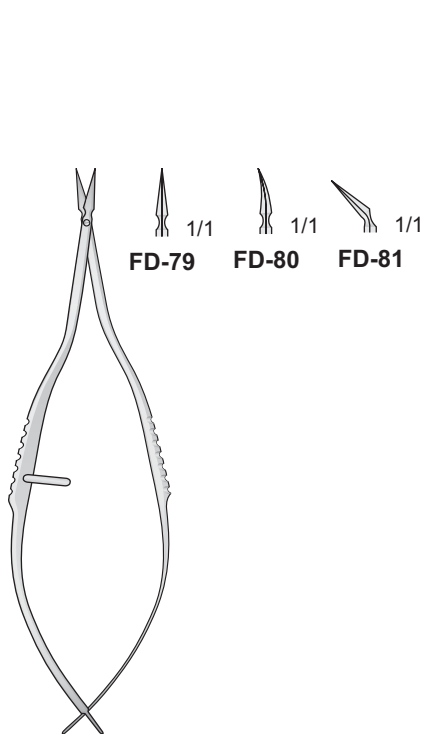

VANNAS
FD-79/FD-81
85 mm

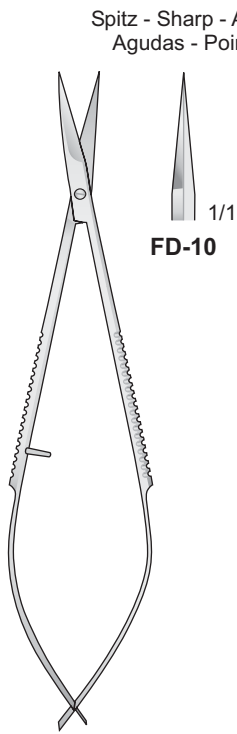

NOYES
FD-10
120 mm

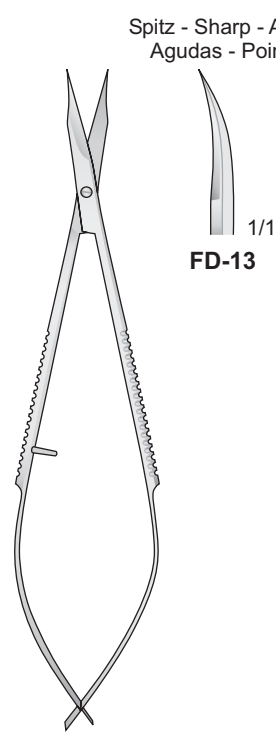

WESTCOTT
FD-13
120 mm

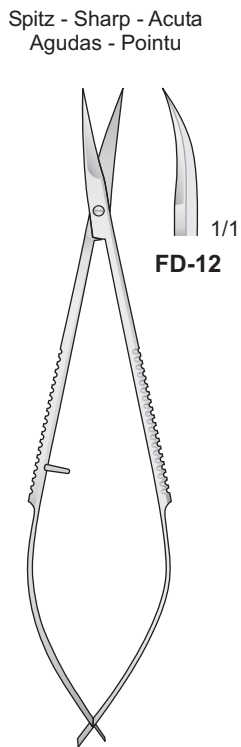

NOYES
FD-12
120 mm

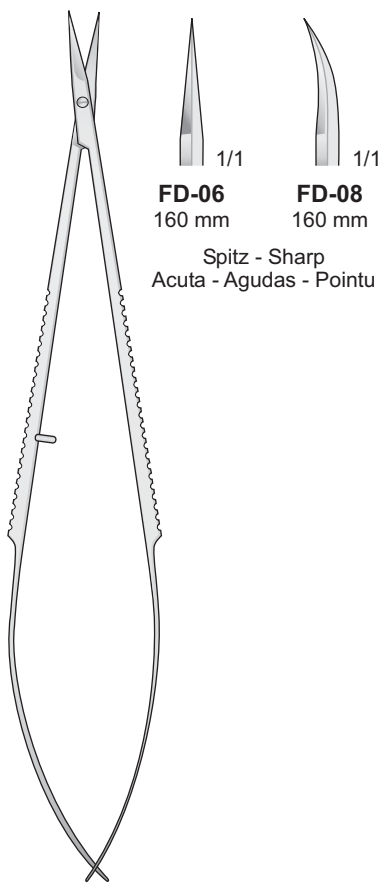

FD-06/FD-08
160 mm

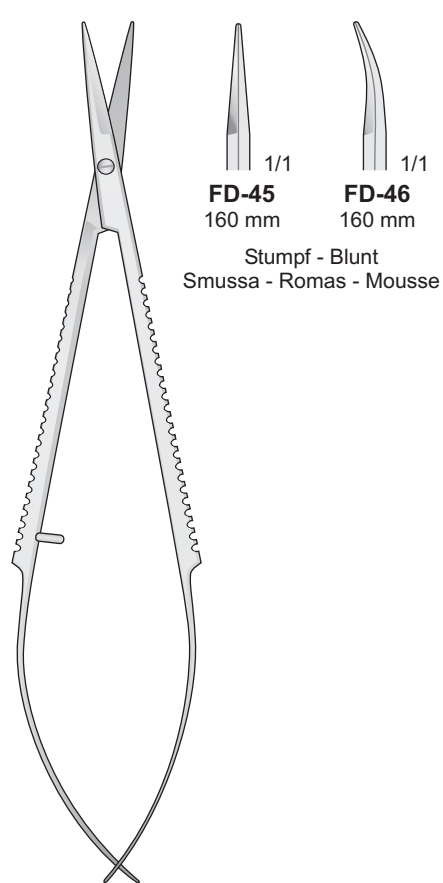

FD-45/FD-46
160 mm

Spitz - Sharp - Acuta
Agudas - Pointu

Spitz - Sharp - Acuta
Agudas - Pointu

Spitz - Sharp - Acuta
Agudas - Pointu

Spitz - Sharp
Acuta - Agudas - Pointu

Stumpf - Blunt
Smussa - Romas - Mousse

Mikro Scheren

Micro scissors

Micro forbici

Micro tijeras

Micro ciseaux

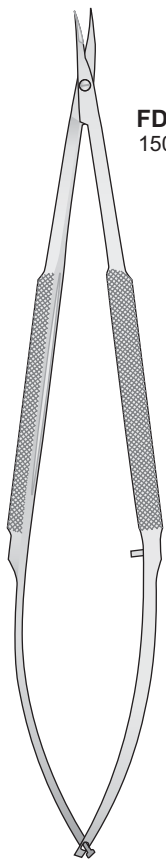

FD-137
150 mm

FD-138
150 mm

FD-137/FD-138
150 mm

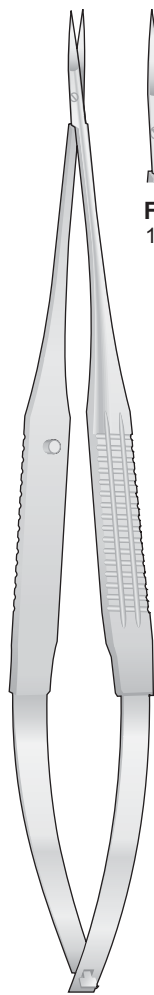

FD-186
185 mm

YASARGIL
FD-186
185 mm

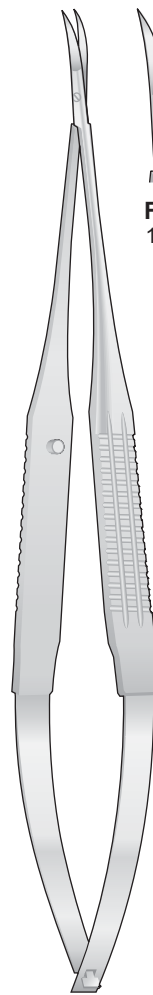

FD-187
185 mm

JACOBSON
FD-187
185 mm

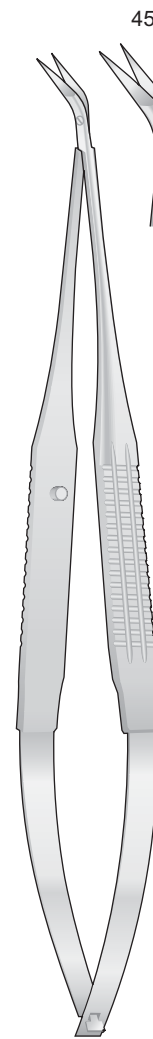

FD-191
185 mm

POTTS-YASARGIL
FD-191
185 mm

Mikro Scheren

Micro scissors

Micro forbici

Micro tijeras

Micro ciseaux

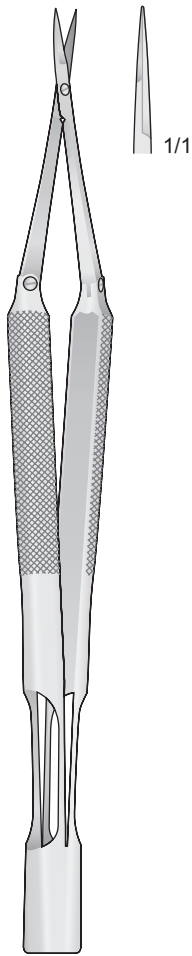

**BROCK
FD-221**
150 mm

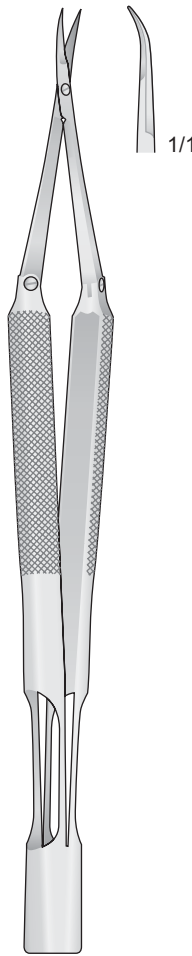

**BROCK
FD-223**
150 mm

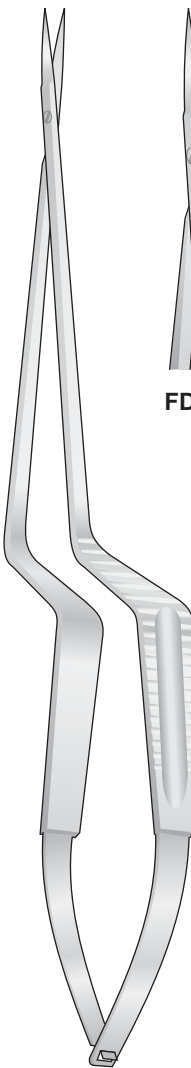

FD-306/FD-311
190 mm



FD-306

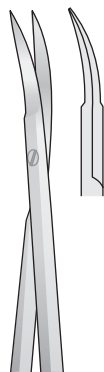

FD-307

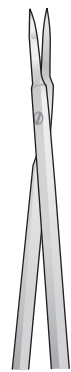

FD-310

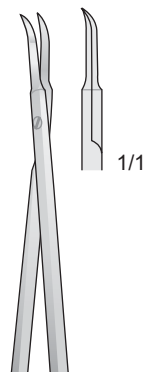

FD-311

Mikro Feine Scheren

Micro delicate scissors

Micro forbici delicate

Micro tijeras finas

Micro ciseaux délicate

Forbici ad anelli grandi

Iris scissors

Blepharoplasty
Blefaroplastica

Spitz - Sharp
Acuta - Aguda
Pointu

Spitz - Sharp
Acuta - Aguda
Pointu

Stumpf - Blunt
Smussa - Romas
Mousse

Spitz - Sharp
Acuta - Aguda
Pointu

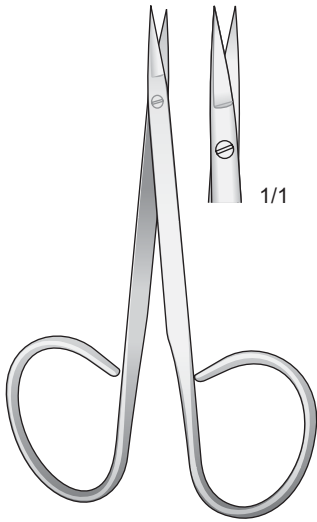

FG-200
95 mm

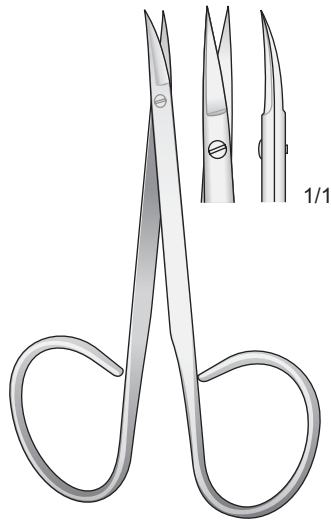

FG-201
95 mm

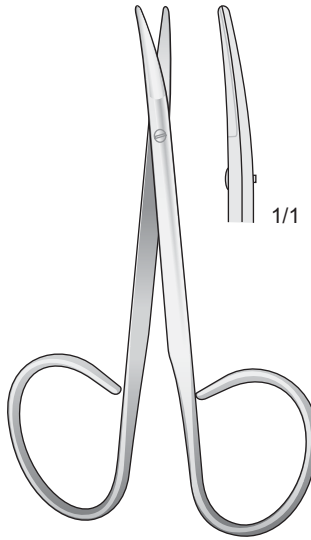

FG-202
95 mm

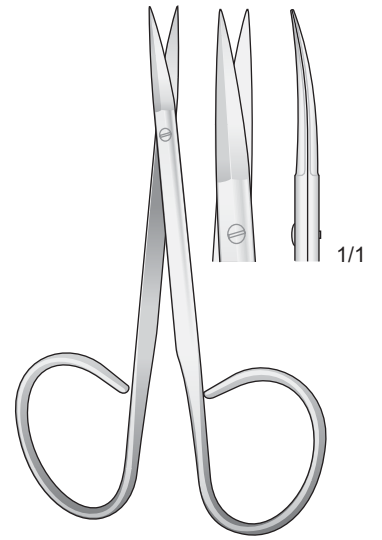

FG-203
105 mm

Iris scissors

Stumpf - Blunt
Smussa - Romas
Mousse

Stumpf - Blunt
Smussa - Romas
Mousse

Spitz - Sharp
Acuta - Aguda
Pointu

Spitz - Sharp
Acuta - Aguda
Pointu

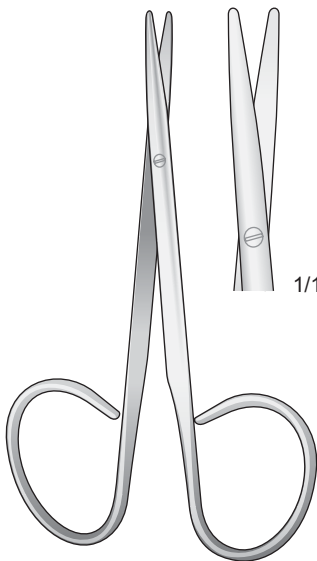

FG-204
100 mm

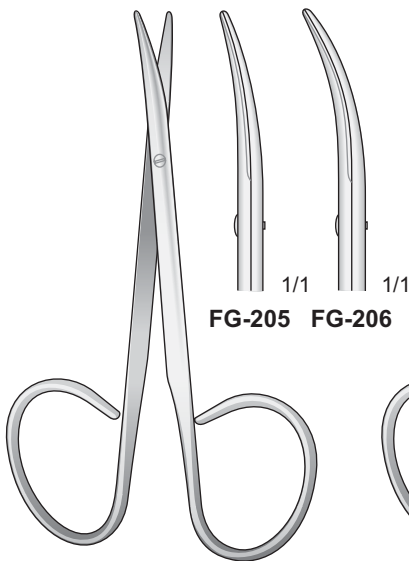

FG-205/FG-206
100 mm

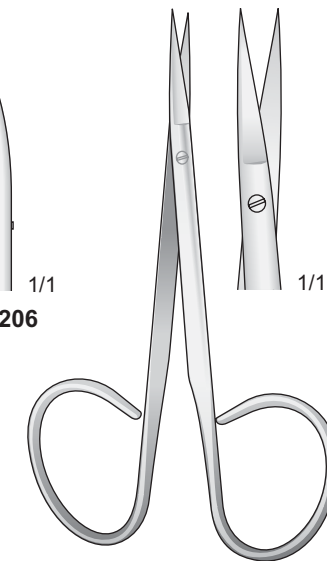

FG-207
105 mm

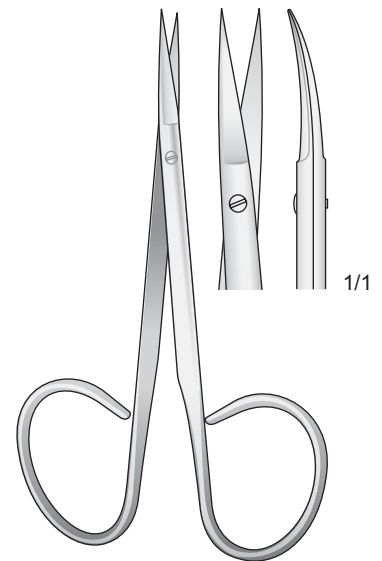

FG-208
105 mm

Forbici ad anelli grandi

Stumpf - Blunt
Smussa - Romas
Mousse

Stumpf - Blunt
Smussa - Romas
Mousse

Spitz - Sharp
Acuta - Aguda
Pointu

Spitz - Sharp
Acuta - Aguda
Pointu

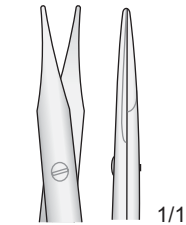
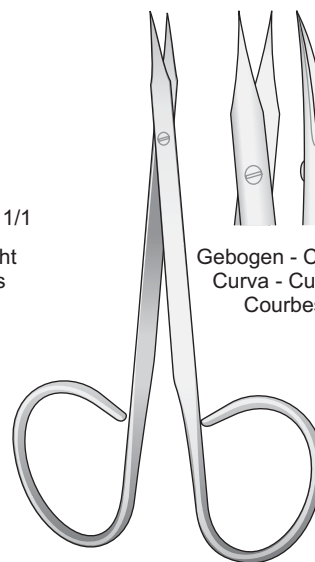
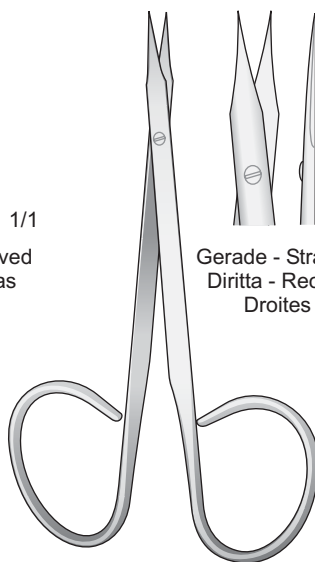
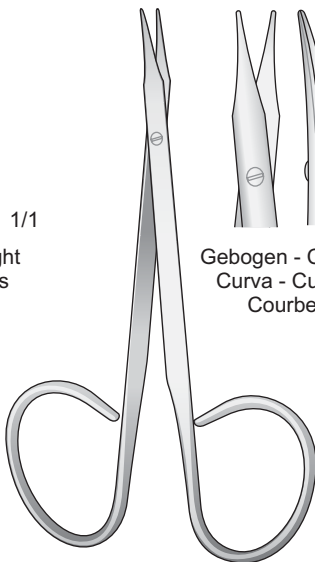
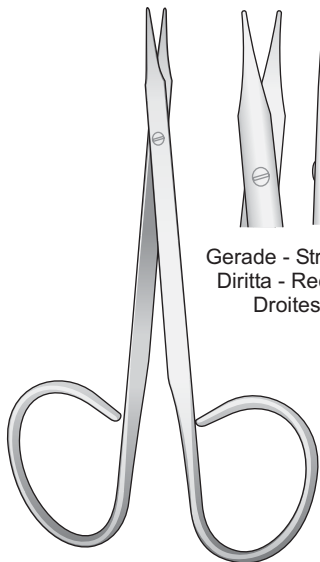

Gerade - Straight
Diritta - Rectas
Droites

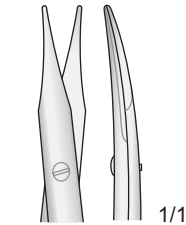

Gebogen - Curved
Curva - Curvas
Courbes

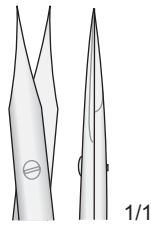

Gerade - Straight
Diritta - Rectas
Droites

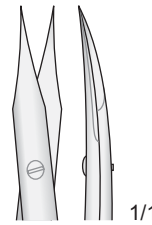

Gebogen - Curved
Curva - Curvas
Courbes

STEVENS
FG-209
100 mm

STEVENS
FG-210
100 mm

WALTON
FG-211
100 mm

WALTON
FG-212
100 mm

Spitz - Sharp
Acuta - Aguda
Pointu

Gezahnt - Serrated
Dentellata - Dentadas
Dentelés

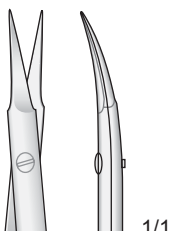
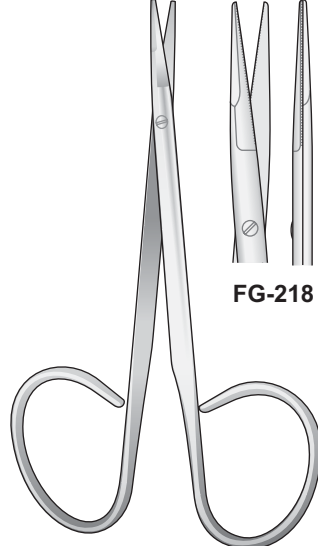
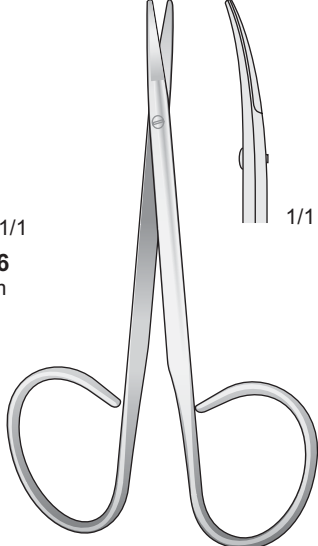
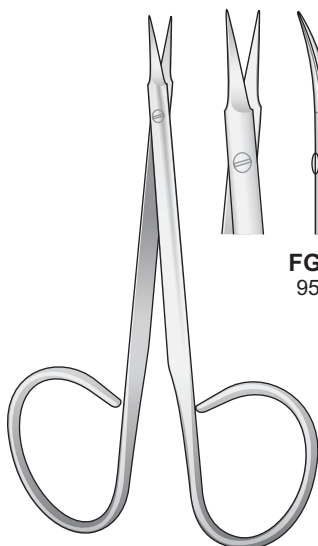

FG-215
95 mm

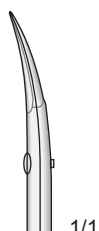

FG-216
115 mm

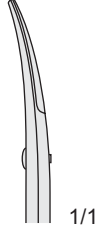

1/1

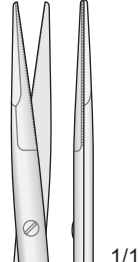

FG-218

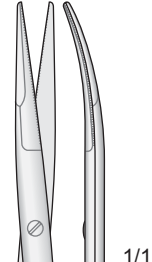

FG-219

STITCH
FG-215/FG-216

RAGNELL
FG-217
100 mm

KAYE
FG-218/FG-219
105 mm

Feine Scheren

Delicate scissors

Forbici delicate

Tijeras finas

Ciseaux délicate

Spitz - Pointed - Acute
Agudas - Pointus

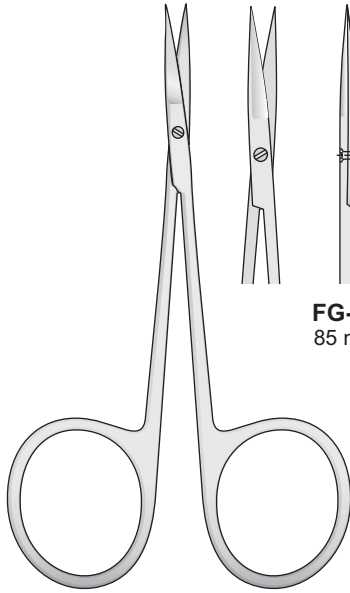

MICRO-IRIS
FG-13/FG-15
85 mm

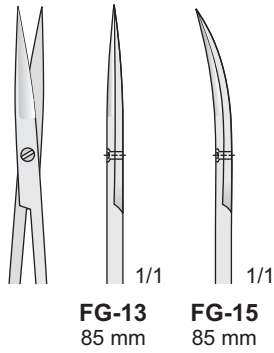

FG-4/FG-5
105 mm

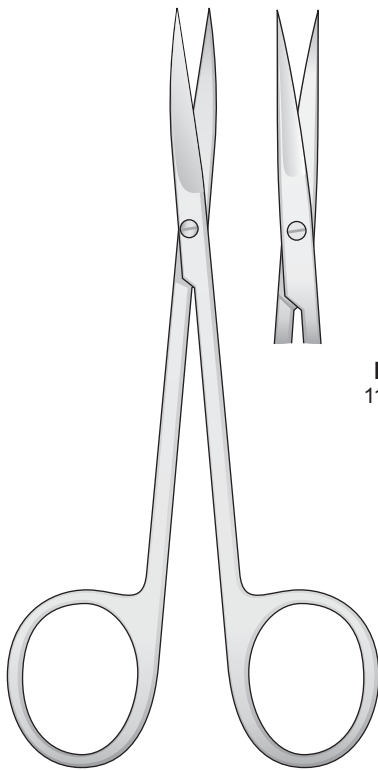
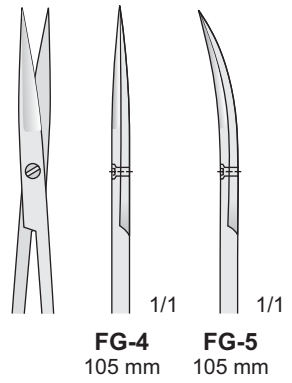

IRIS
FG-1/FG-2
110 mm

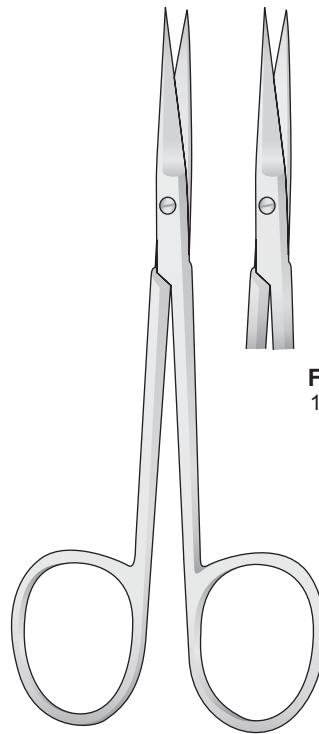
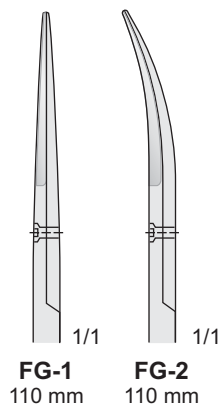

FG-104
100 mm

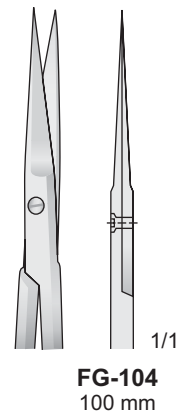

Feine Scheren

Delicate scissors

Forbici delicate

Tijeras finas

Ciseaux délicate

Stumpf - Blunt
Smussa - Romo - Émoussé

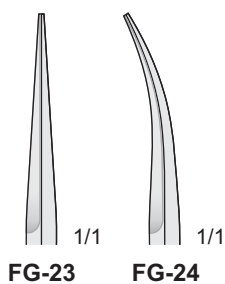
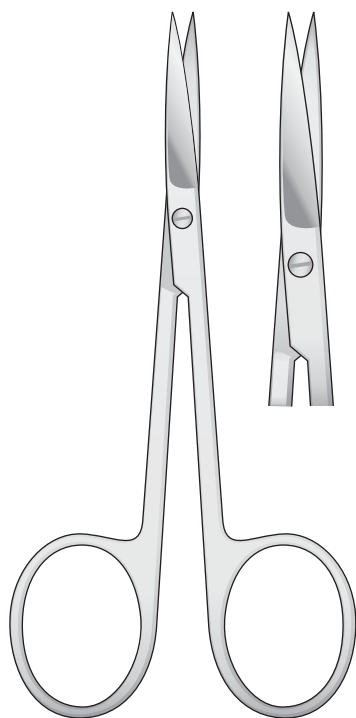

FG-23/FG-24
110 mm

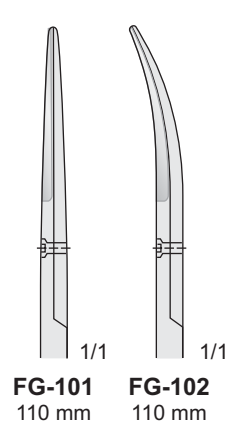
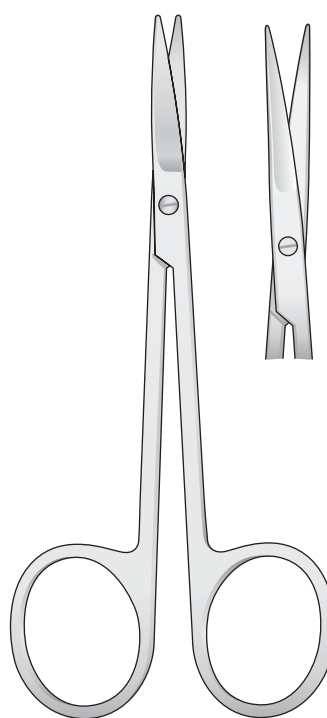

FG-101/FG-102
110 mm

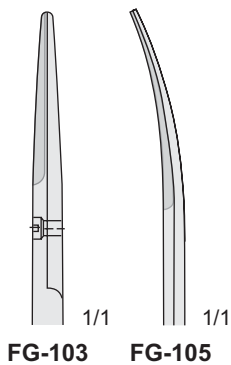
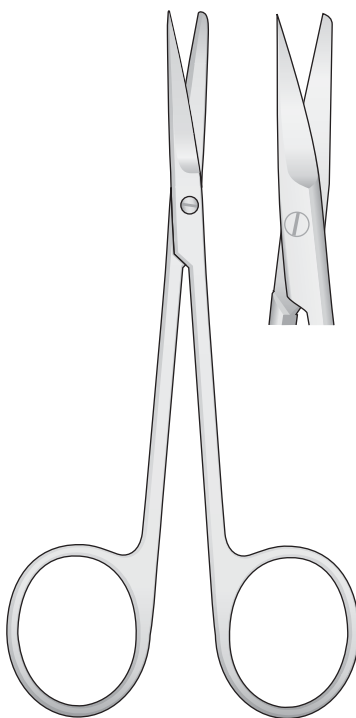

FG-103/FG-105
110 mm

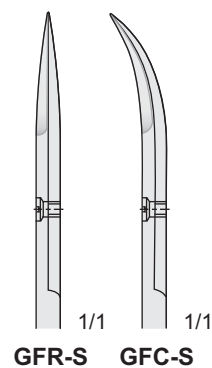
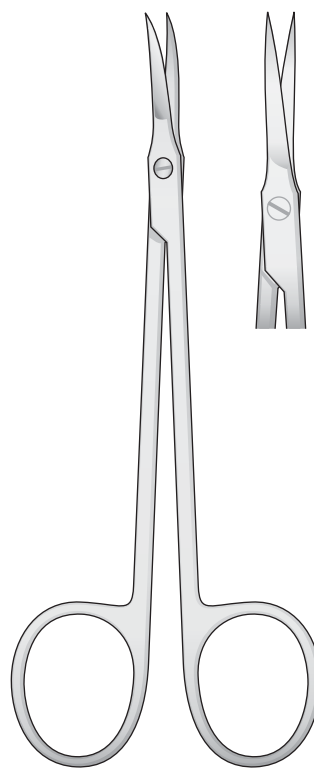

GFR-S/GFC-S
120 mm

Feine Scheren

Delicate scissors

Forbici delicate

Tijeras finas

Ciseaux délicate

Stumpf
Blunt
Smussa
Romas
Mousse

Spitz
Sharp
Acuta
Aguda
Pointu

Spitz
Sharp
Acuta
Aguda
Pointu

Stumpf
Blunt
Smussa
Romas
Mousse

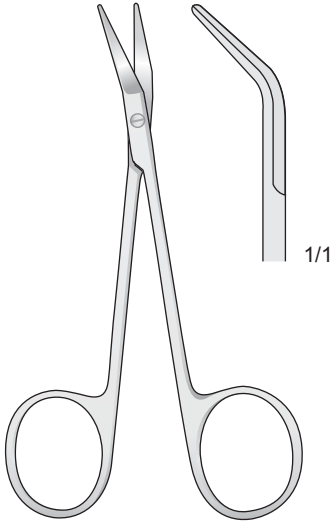

GRAEFE
FG-30
100 mm

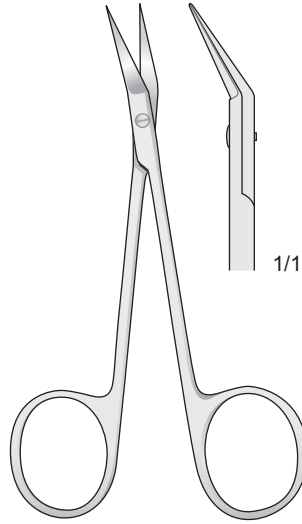

WILMER
FG-122
105 mm

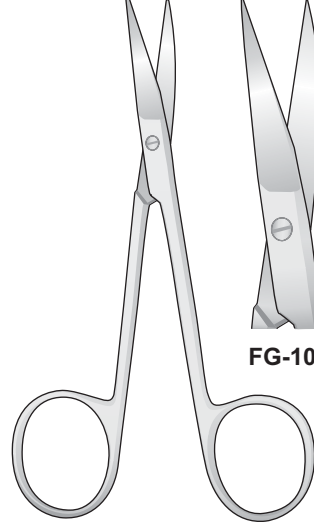

COTTLE-MASING
FG-108/FG-109
105 mm

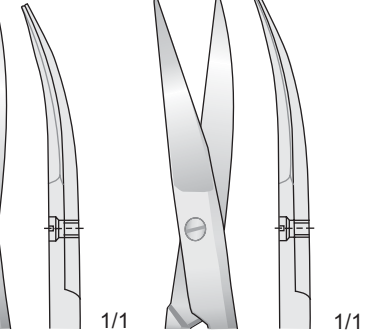

FG-109

Spitz
Sharp
Acuta
Aguda
Pointu

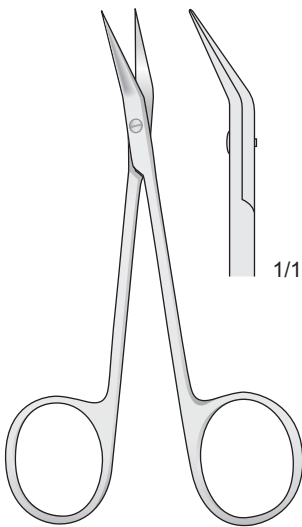

BIRO
FG-94
100 mm

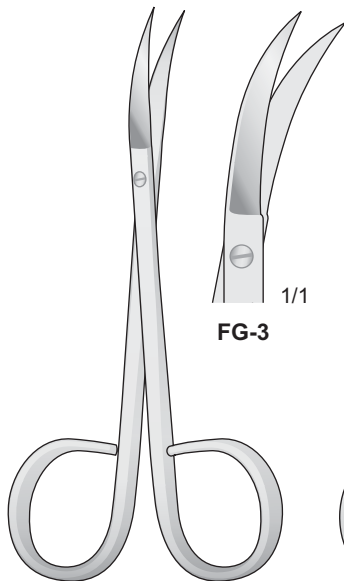

FG-3
115 mm

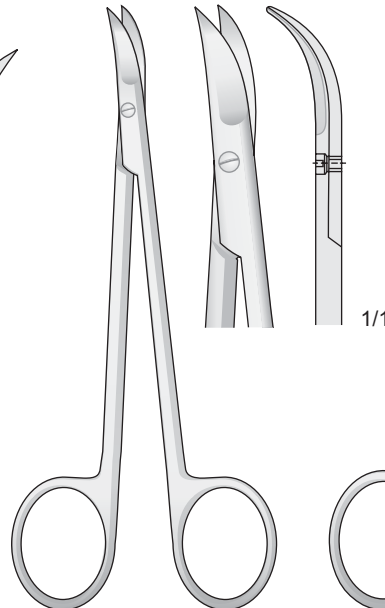

CHADWICK
FG-39
115 mm

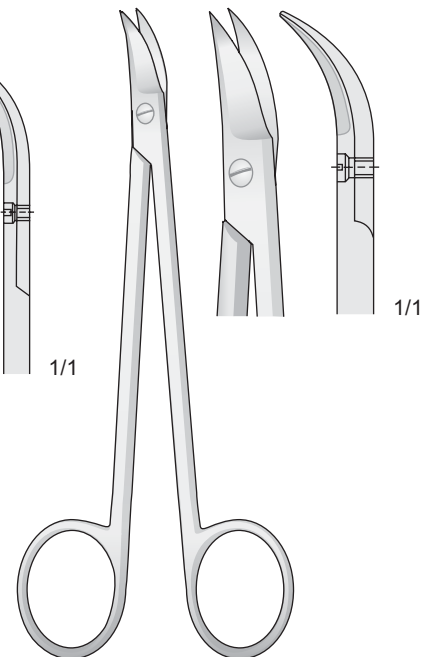

QUINBY
FG-38
130 mm

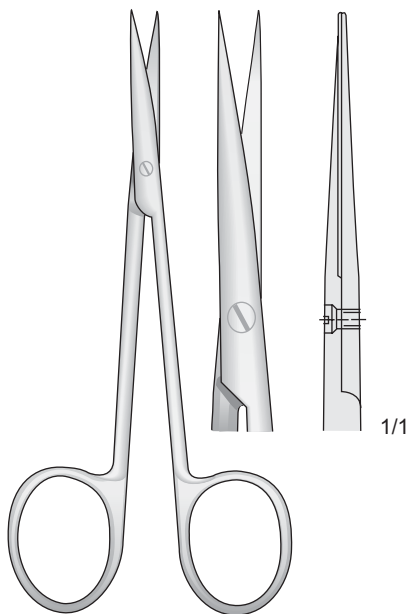

KILNER
FG-58
115 mm

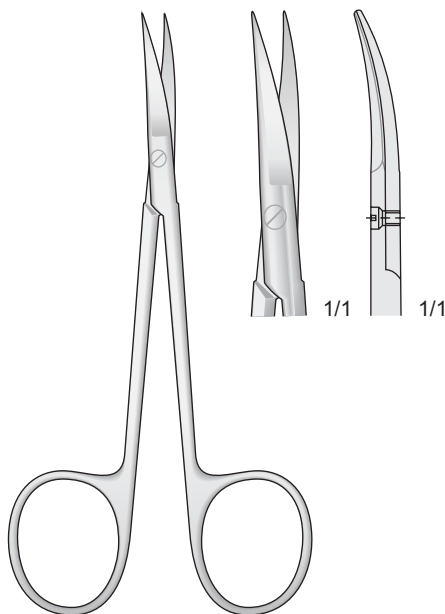

COTTLE
FG-59
115 mm

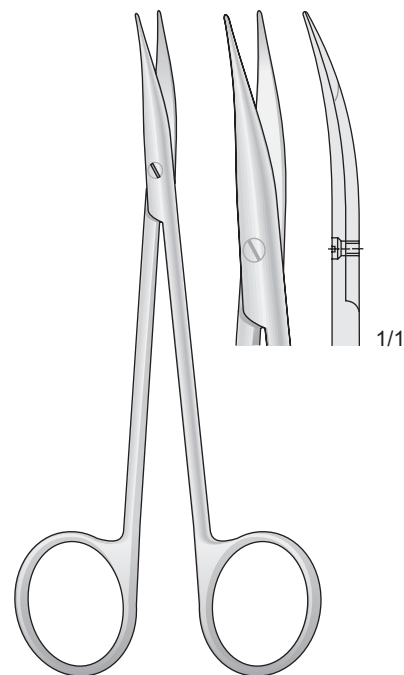

JAMESON-WERBER
FG-123
130 mm

Stumpf - Blunt
Smussa - Romo - Émoussé

Spitz - Sharp
Acuta - Agudo - Aigu

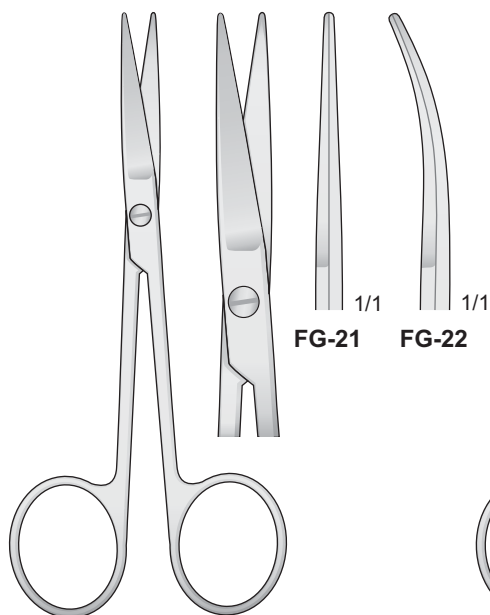

FG-21/FG-22
115 mm

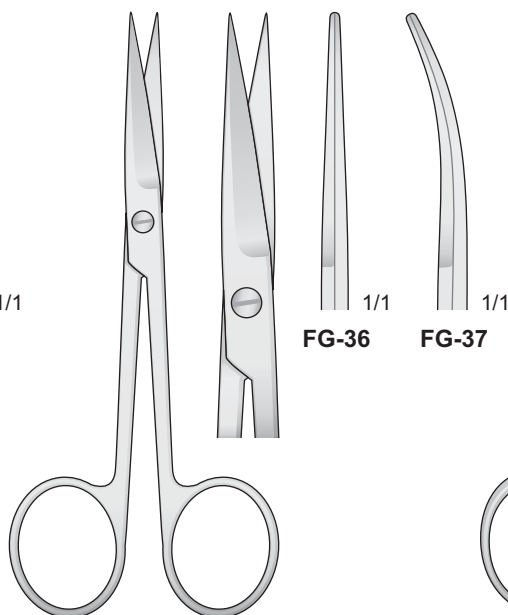

FG-36/FG-37
115 mm

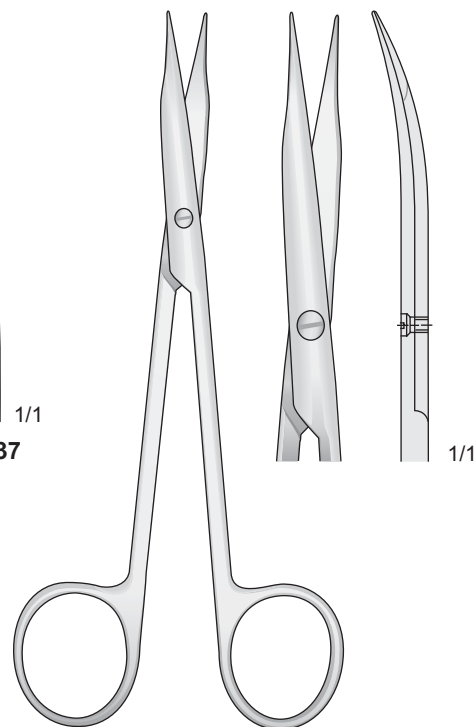

JAMESON
FG-124
145 mm

Gezahnt - Sawedge - Dentellata - Dentadas - Dentelé

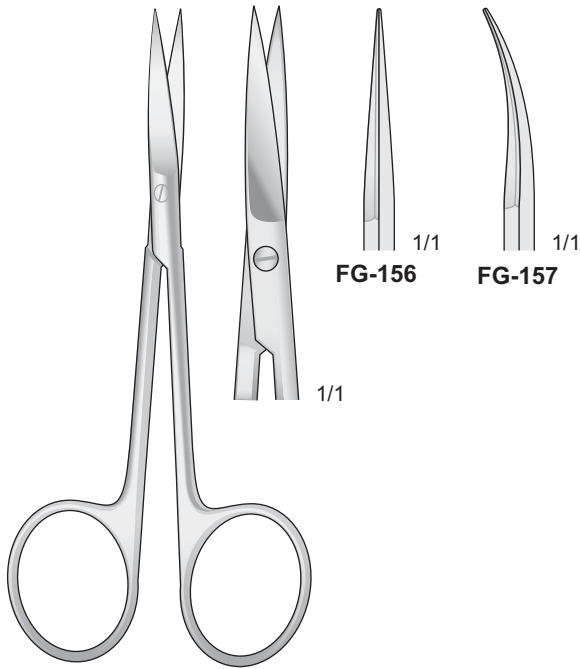

FG-156/FG-157
110 mm

Gezahnt - Sawedge - Dentellata - Dentadas - Dentelé

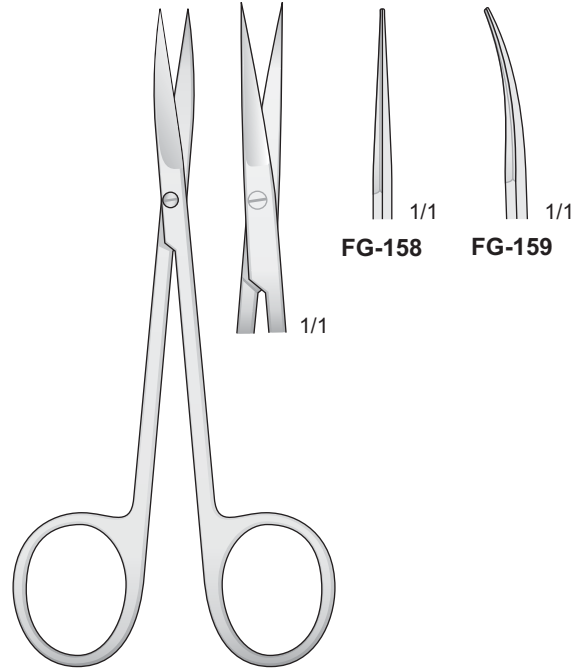

FG-158/FG-159
110 mm

Plastikscheren
Plastic Scissors
Forbici per Plastica

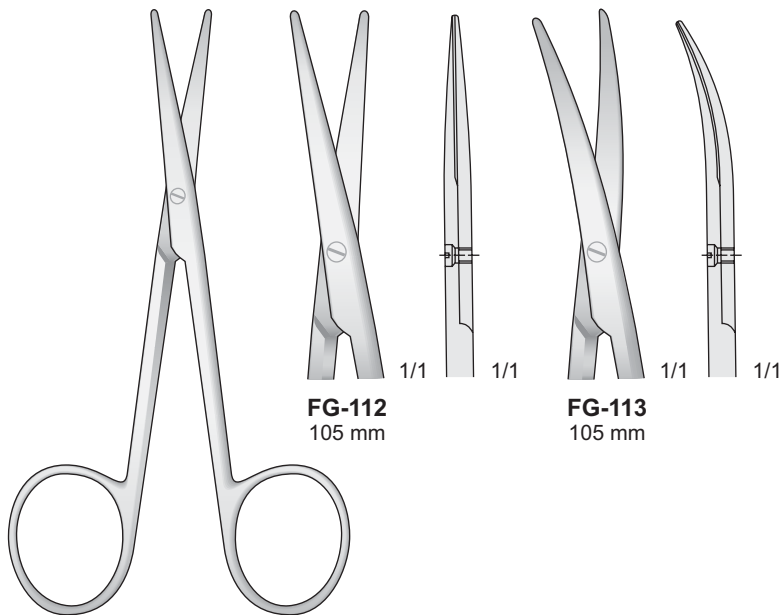

COTTLE-KNAPP
FG-112/FG-113
105 mm
(LEXER-BABY)

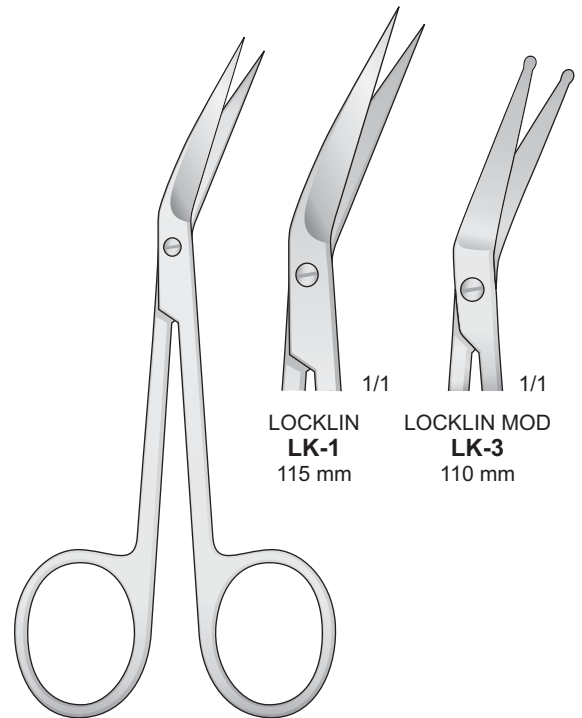

LK-1/LK-3

Feine Scheren

Delicate scissors

Forbici delicate

Tijeras finas

Ciseaux délicate

Gezahnt - Sawedge - Dentellata - Dentadas - Dentelé

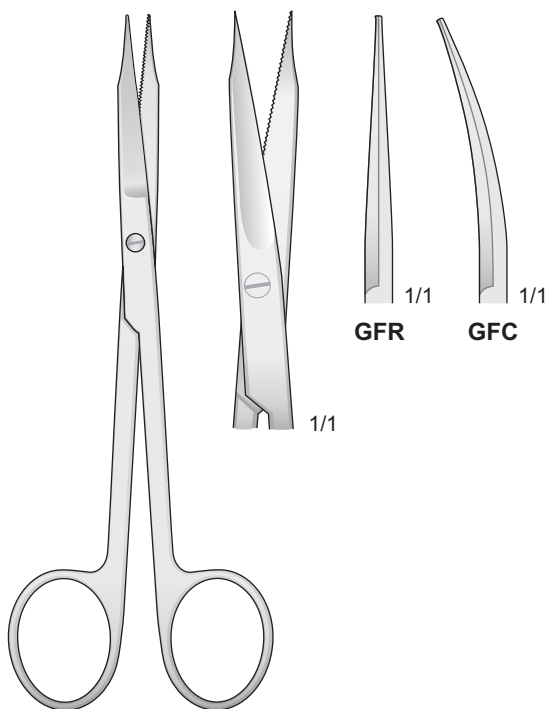

GOLDMAN-FOX
GFR/GFC
120 mm

S Form

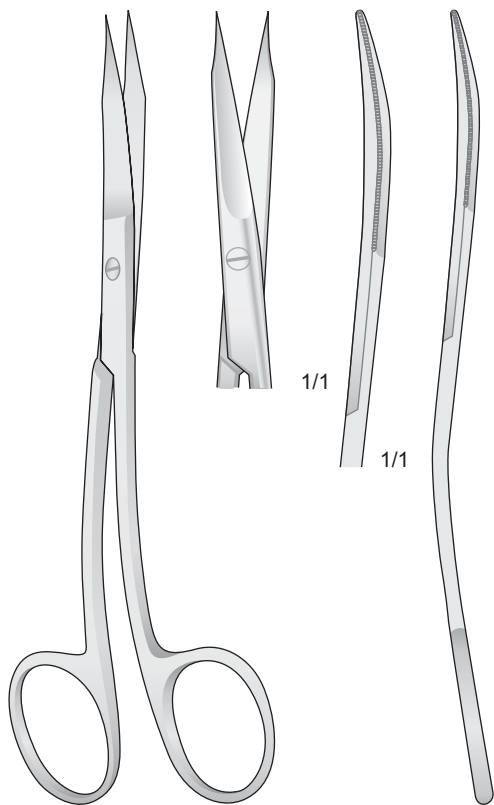

GOLDMAN-FOX
GFS
130 mm

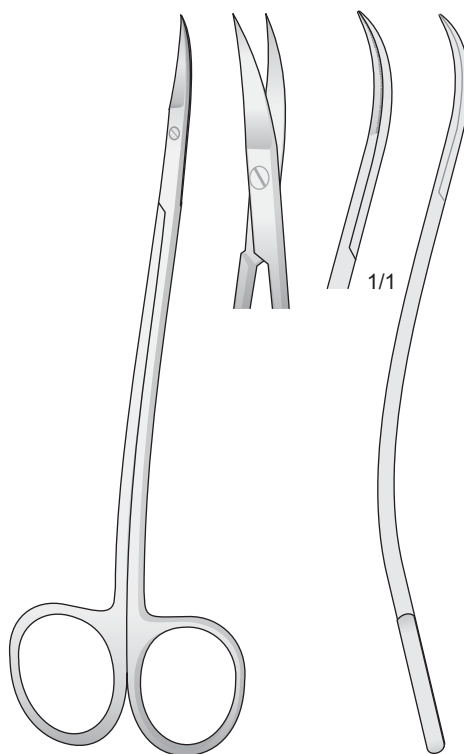

LA GRANGE
LG-1
115 mm

Feine Scheren

Delicate scissors

Forbici delicate

Tijeras finas

Ciseaux délicate

Stumpf - Blunt - Smusse - Romas - Mouses

Spitz - Pointed - Acute - Agudas - Pointus

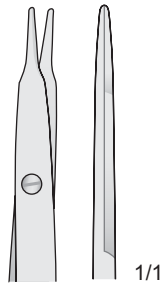
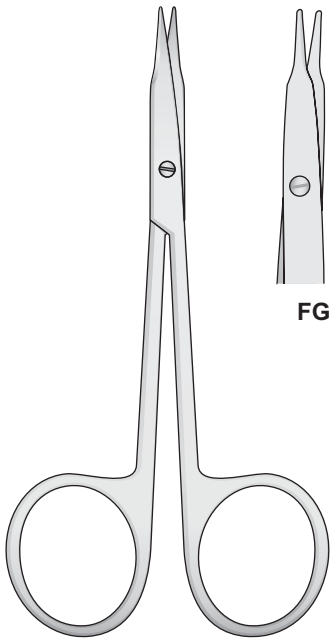

FG-50

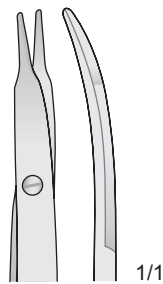

FG-51

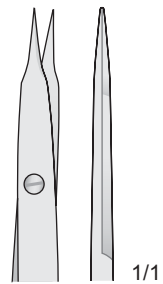

FG-52

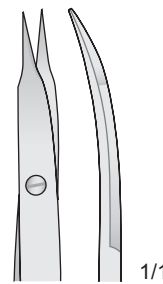

FG-53

STEVENS
FG-50/FG-53
110 mm

Stumpf - Blunt - Smussa
Romas - Mousse

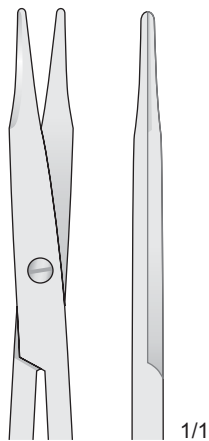
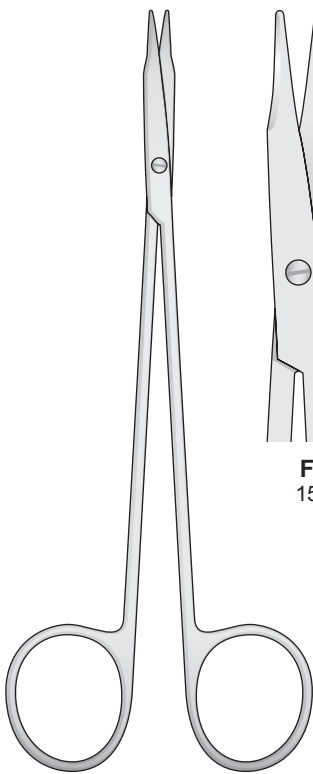

FG-54
150 mm

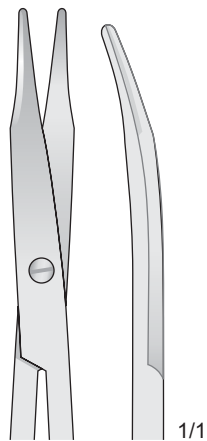

FG-55
150 mm

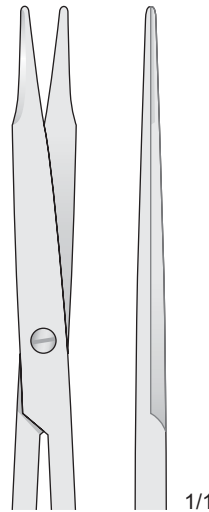

FG-56
180 mm

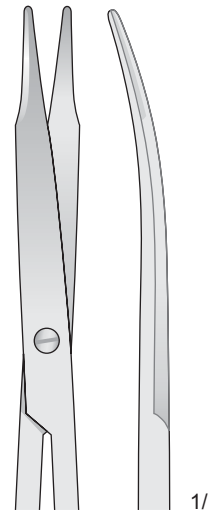

FG-57
180 mm

REYNOLDS
FG-54/FG-57

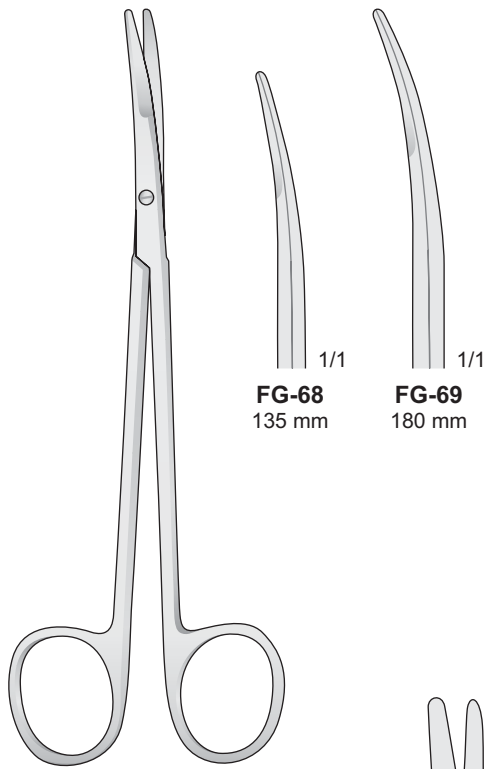

GLASSMAN
FG-68/FG-69

FG-68
135 mm

FG-69
180 mm

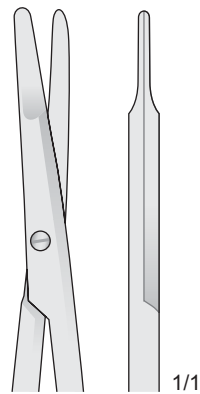

FG-66
120 mm

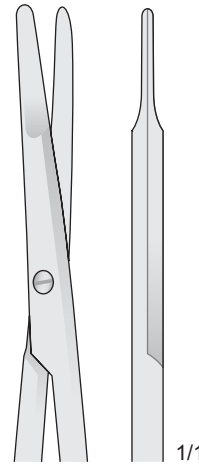

FG-19R
135 mm

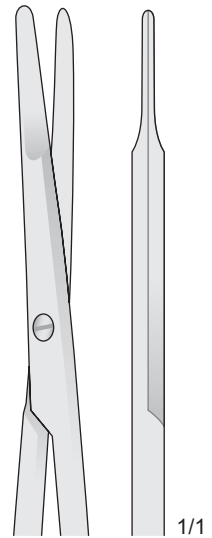

FG-6R
150 mm

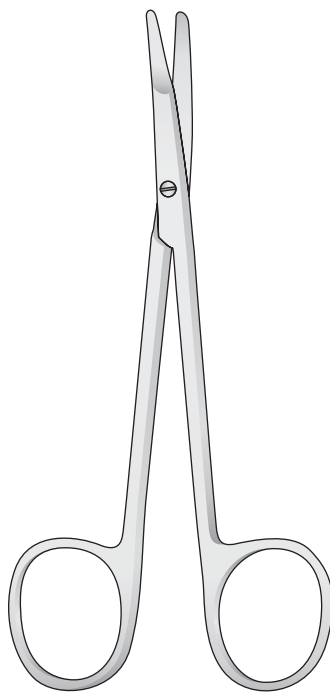

KILNER
FG-6C/FG-66

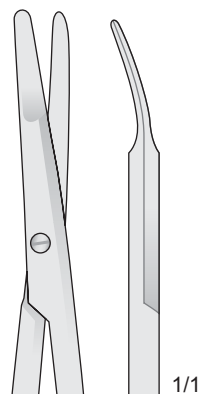

FG-67
120 mm

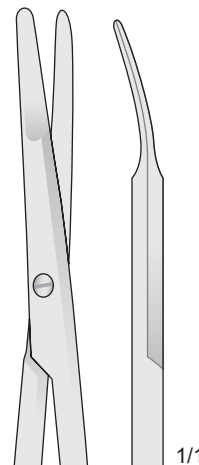

FG-19C
135 mm

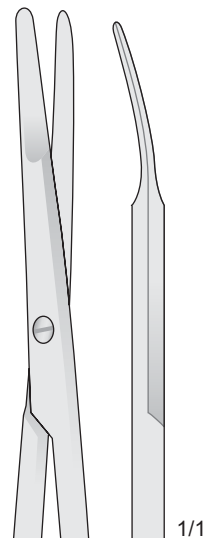

FG-6C
150 mm

Gezahnt - Saw edge - Dentellate
Dentadas - Dentelès

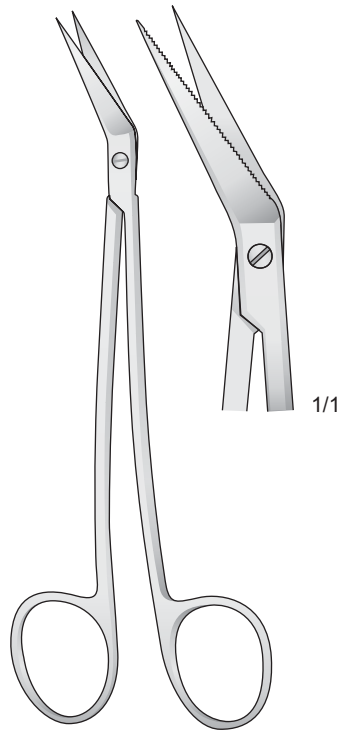

LOCKLIN
LK-2
160 mm

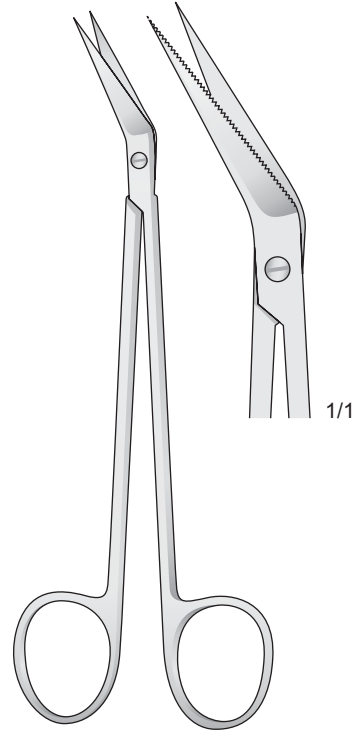

LOCKLIN
LK-4
160 mm

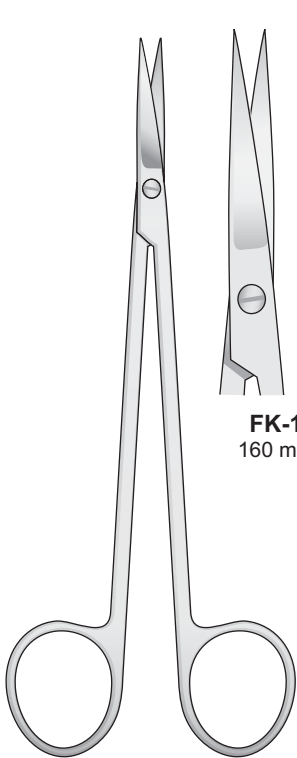

KELLY
FK-1/FK-87

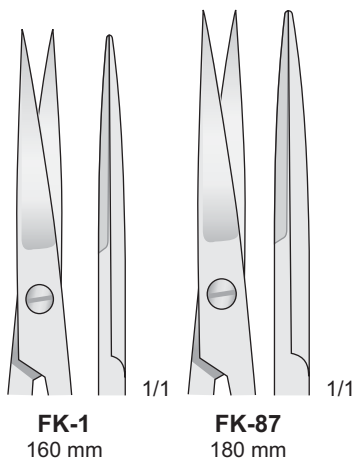

FK-1
160 mm

FK-87
180 mm

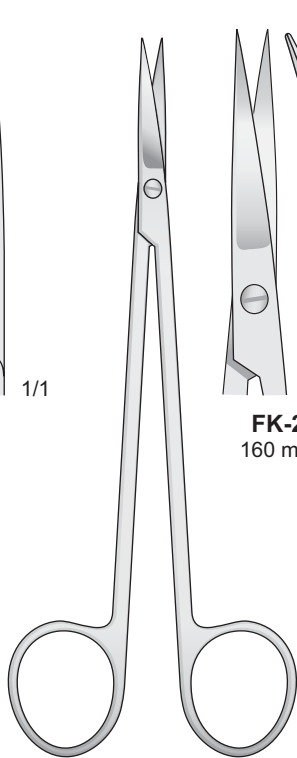

KELLY
FK-2/FK-88

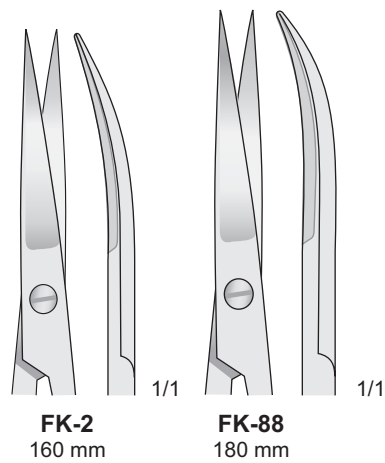

FK-2
160 mm

FK-88
180 mm

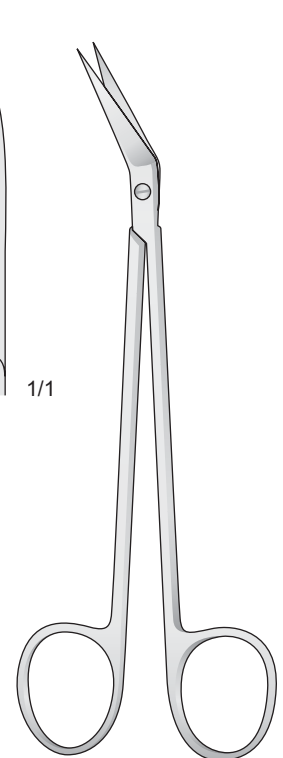

KELLY
FK-10
160 mm

Standard

Stumpf - Blunt
Smusse - Romas
Mousses

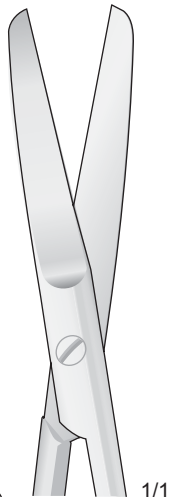

1/1

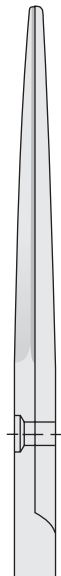

1/1

FM-35
130 mm



1/1

FM-9
145 mm

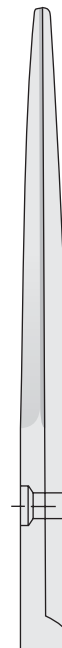

1/1

FM-37
165 mm

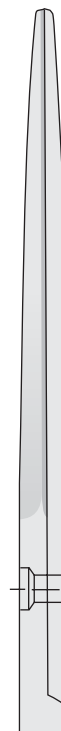

1/1

FM-39
185 mm

FM-9/FM-39

Stumpf - Blunt
Smusse - Romas
Mousses

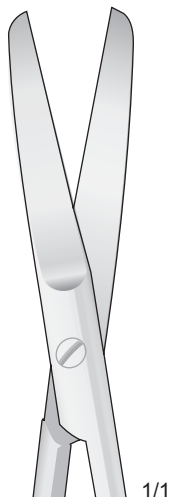
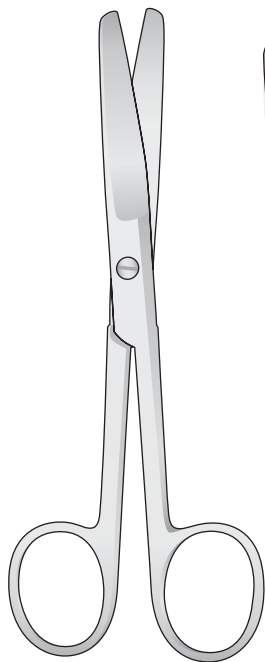

1/1



1/1

FM-36
130 mm

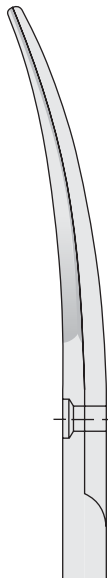

1/1

FM-10
145 mm



1/1

FM-38
165 mm



1/1

FM-40
185 mm

FM-10/FM-40

Standard

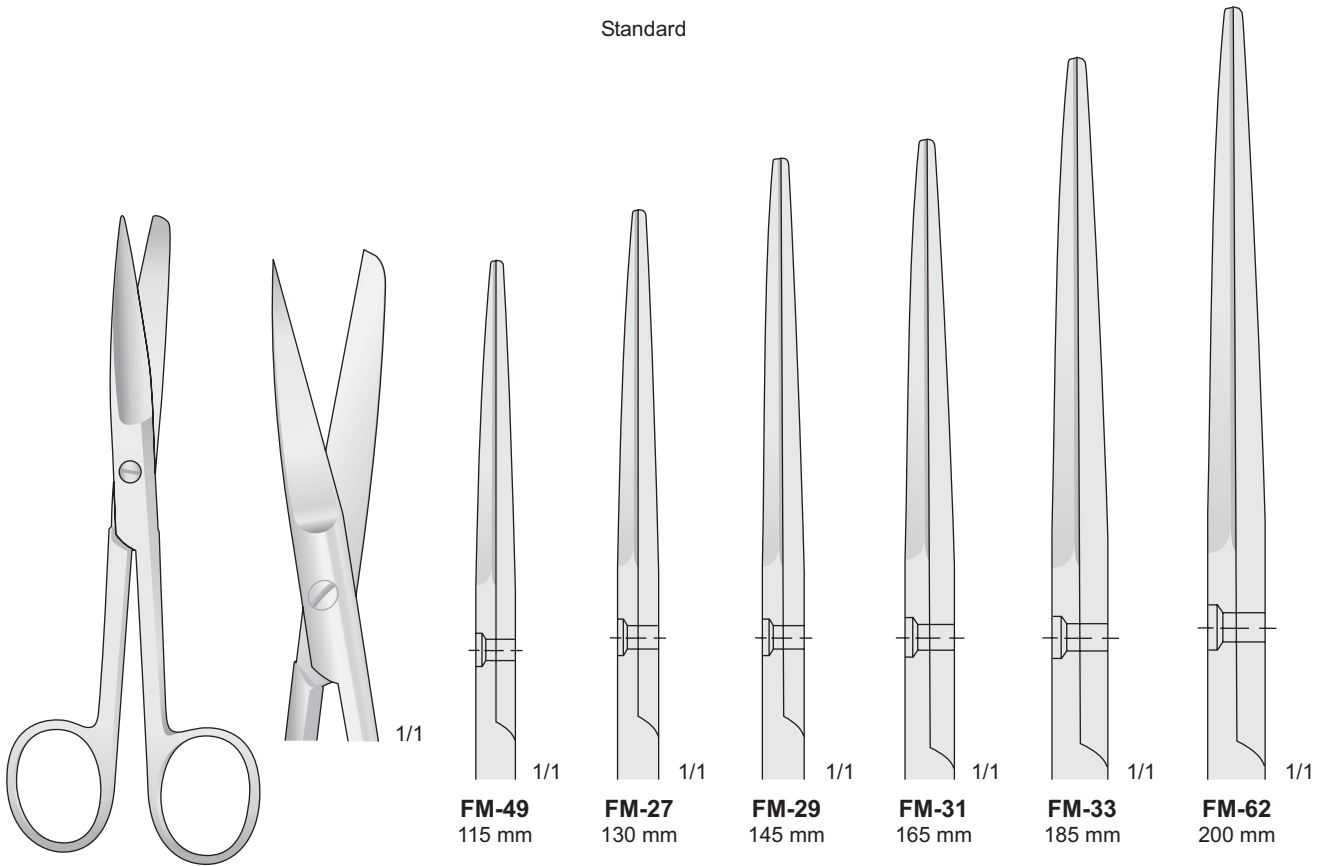

FM-27/FM-62

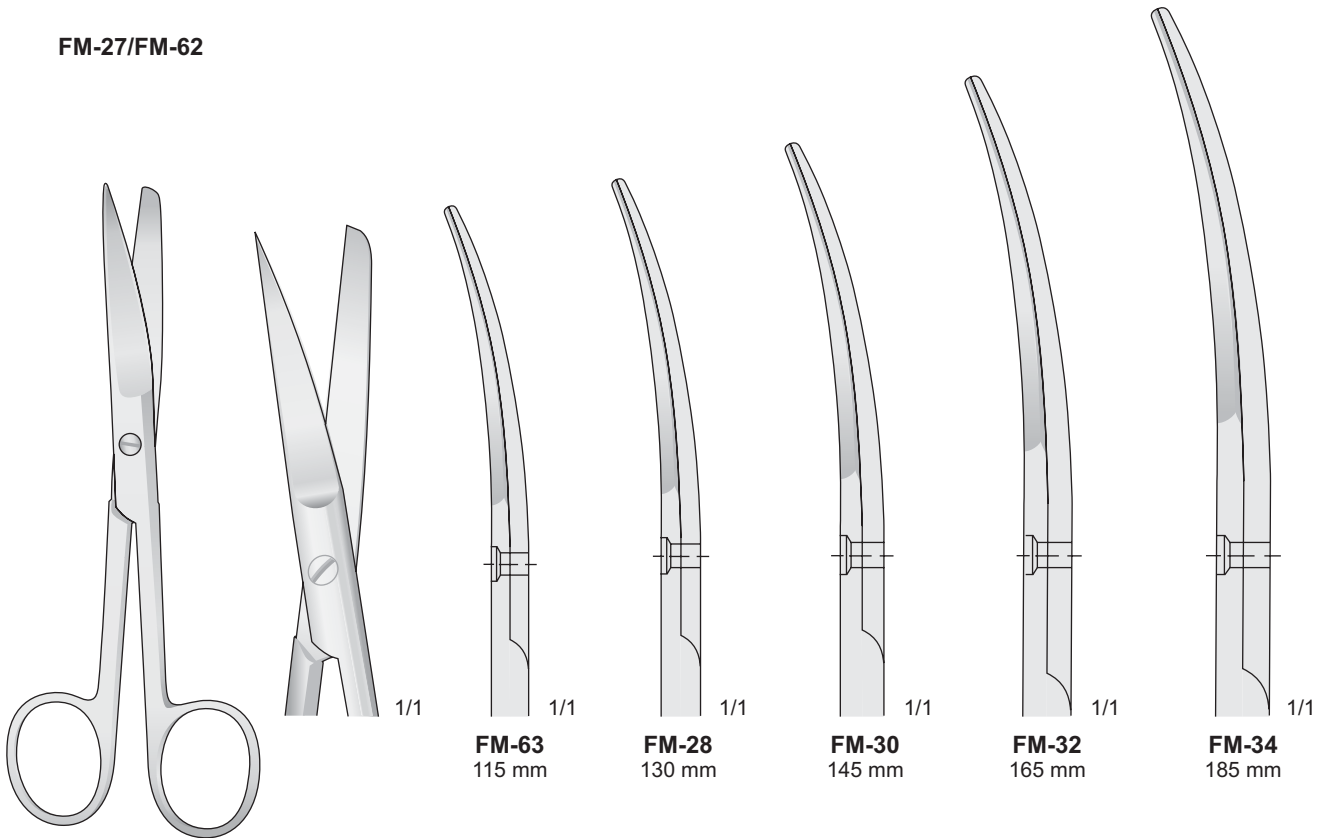

FM-28/FM-63

Standard

Spitz - Sharp
Acuta - Agudo - Pointu

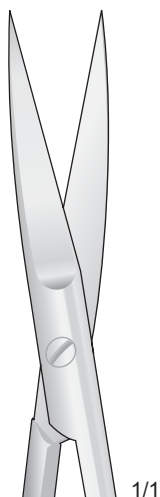
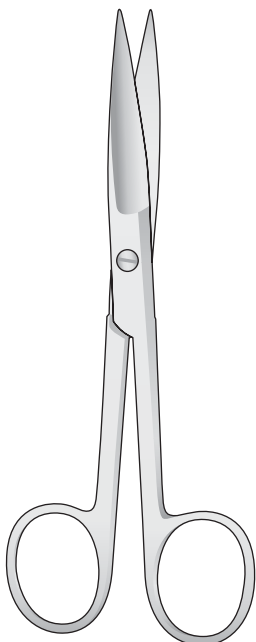

1/1

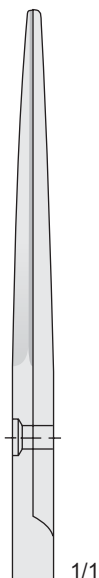

1/1

FM-41
130 mm

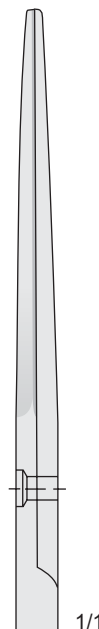

1/1

FM-7
145 mm

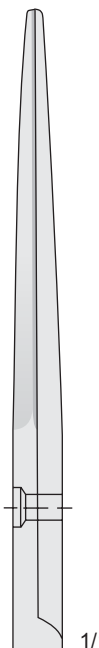

1/1

FM-43
165 mm

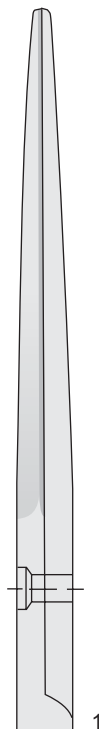

1/1

FM-45
185 mm

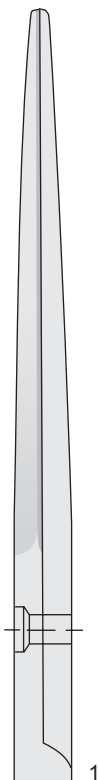

1/1

FM-72
200 mm

FM-7/FM-72

Spitz - Sharp
Acuta - Agudo - Pointu

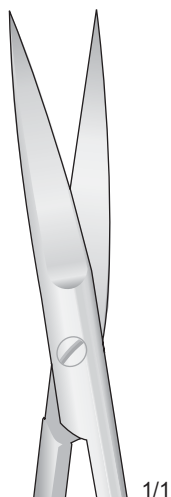
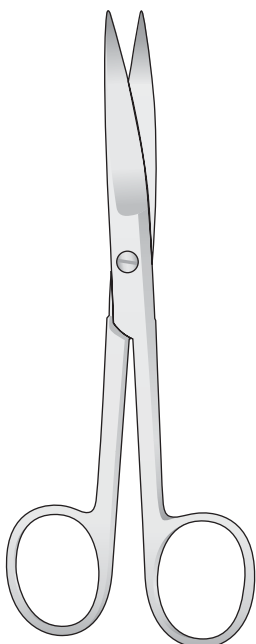

1/1

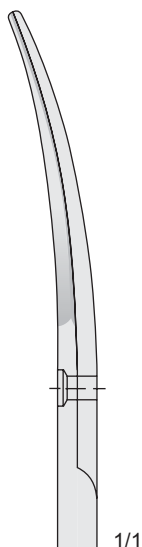

1/1

FM-42
130 mm

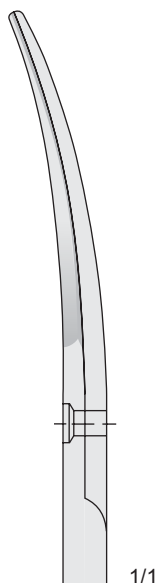

1/1

FM-8
145 mm

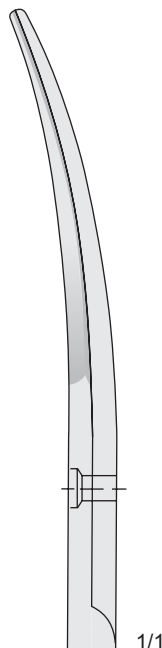

1/1

FM-44
165 mm

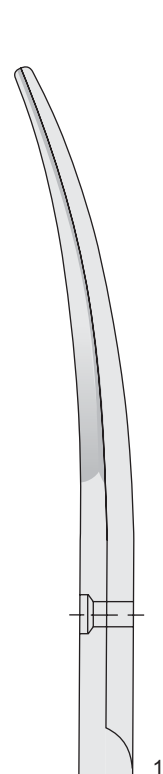

1/1

FM-46
185 mm

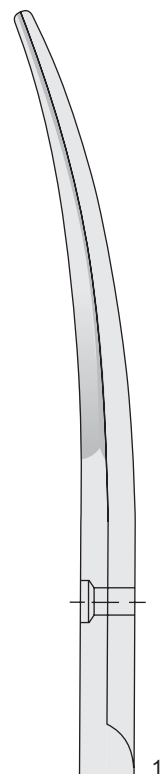

1/1

FM-73
200 mm

FM-8/FM-73

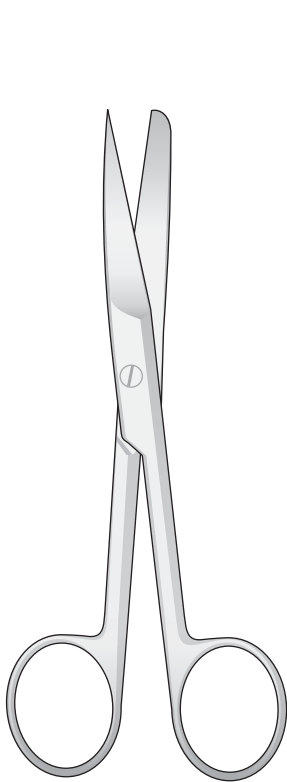

DEAVER
FG-47/FG-49
145 mm

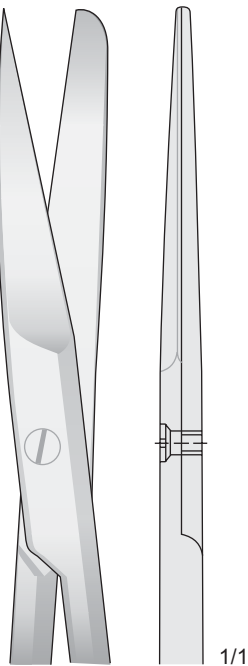

FG-47
145 mm

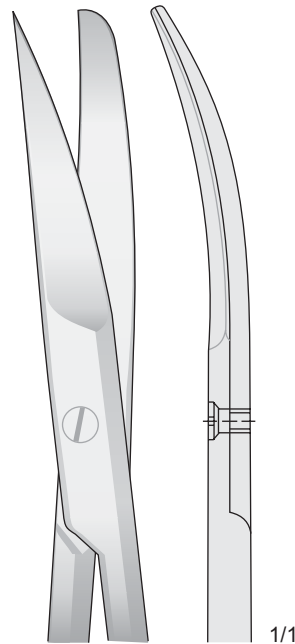

FG-48
145 mm

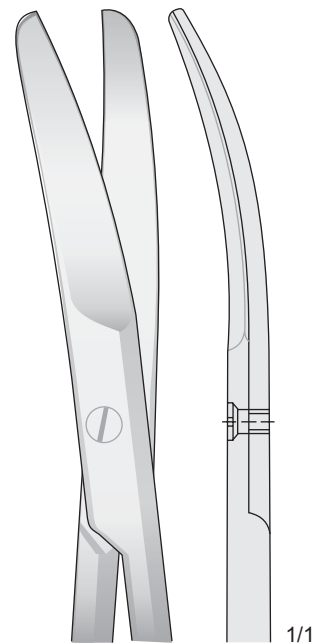

FG-49
145 mm

Inzisionscheren - Incision scissors
Forbici da incisione - Tijeras para incisión
Ciseaux à incision

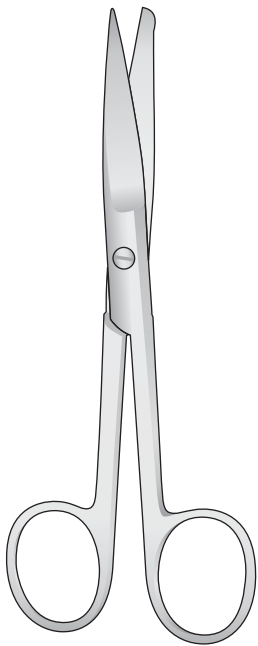

FG-16/FG-117

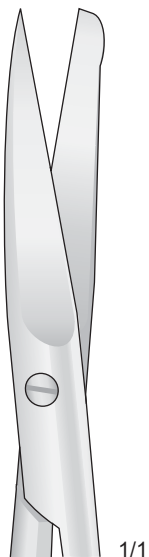

FG-16
130 mm

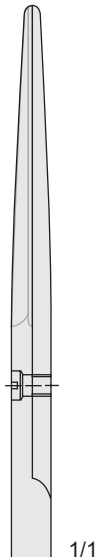

FG-17
145 mm

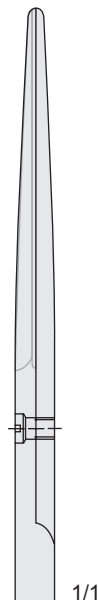

FG-117
165 mm

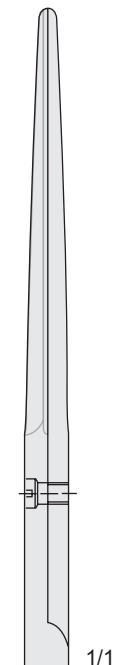
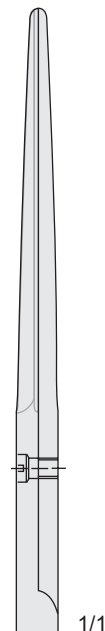

FG-18
185 mm

Chirurgische Scheren

Operating Scissors

Forbici chirurgiche

Tijeras para cirugía

Ciseaux chirurgicaux

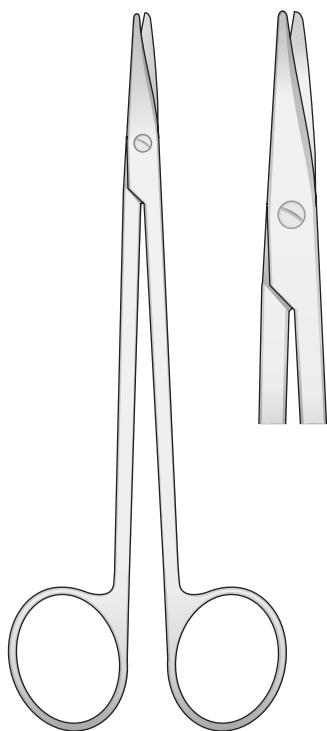

METZENBAUM
FM-12/FM-109
150 mm

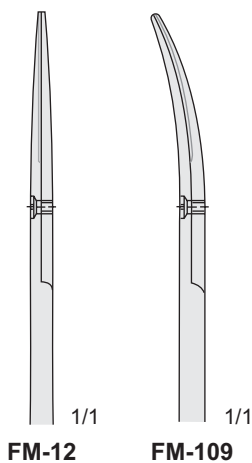

FM-12 1/1
FM-109 1/1

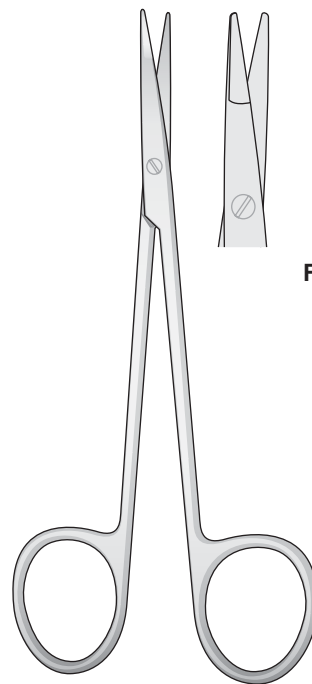

SHEA
FG-90/FG-91
120 mm

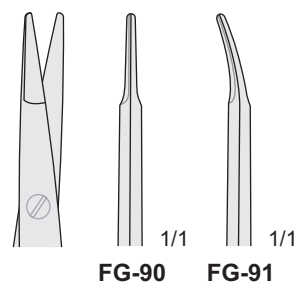

FG-90 1/1
FG-91 1/1

Spitz - Sharp
Acuta - Agudo - Pointu

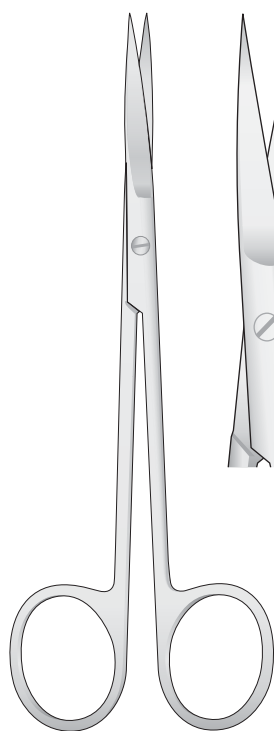

JOSEPH
FG-147/FG-148
150 mm

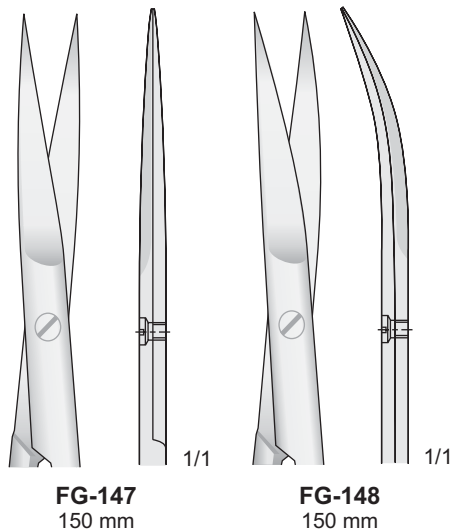

FG-147 1/1
FG-148 1/1

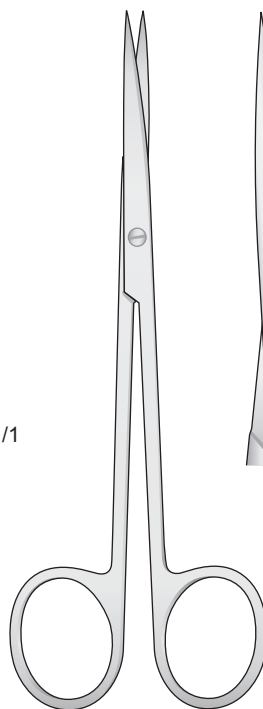

METZENBAUM
FM-126/FM-127
145 mm

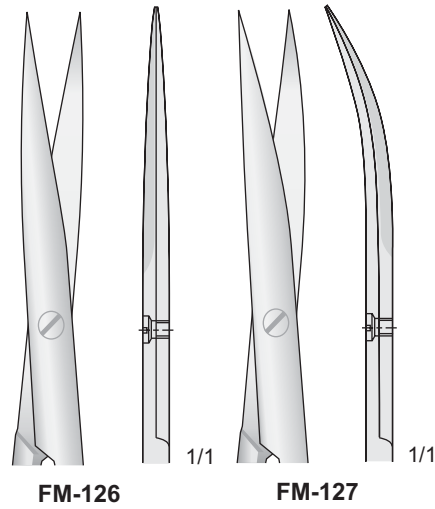

FM-126 1/1
FM-127 1/1

Feine Scheren

Delicate scissors

Forbici delicate

Tijeras finas

Ciseaux délicate

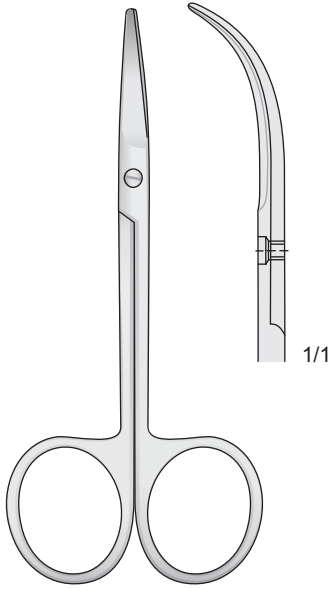

FOMON
FG-43
110 mm

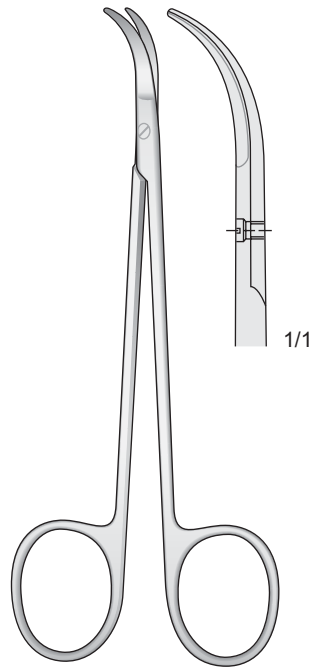

FOMON
FG-93
135 mm

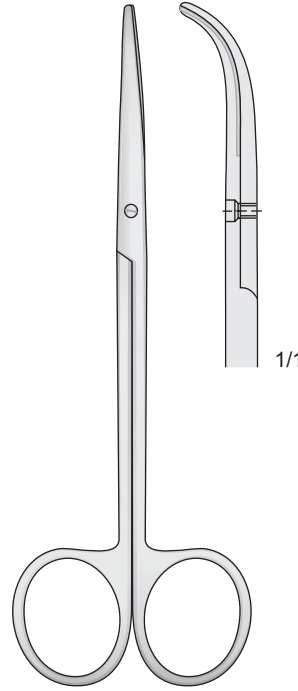

FOMON
FG-44
140 mm

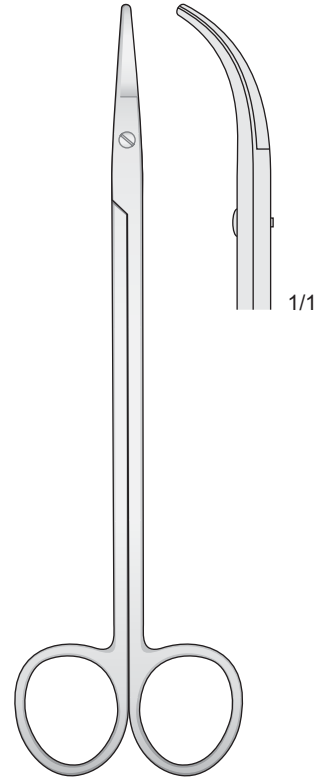

WALTON
FG-146
165 mm

Mit Fadenbohrung - With eye for suture
Con occhiello per sutura - Tijeras para ligaduras
Avec oeil pour les sutures

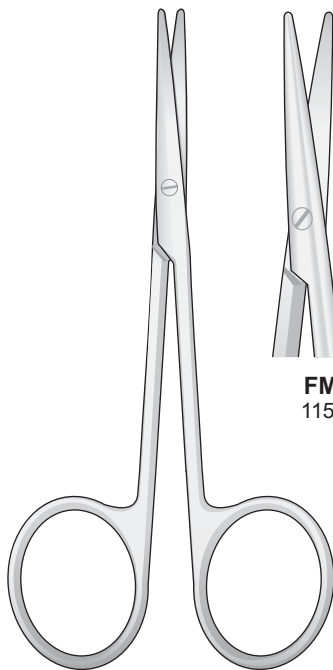

BABY - METZENBAUM
FM-47/FM-48
115 mm

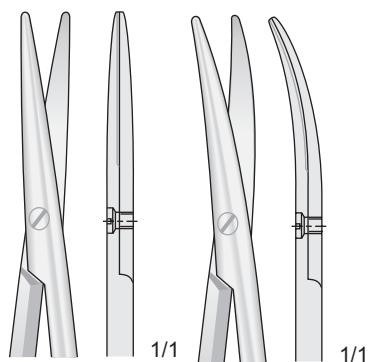

FM-47
115 mm

FM-48
115 mm

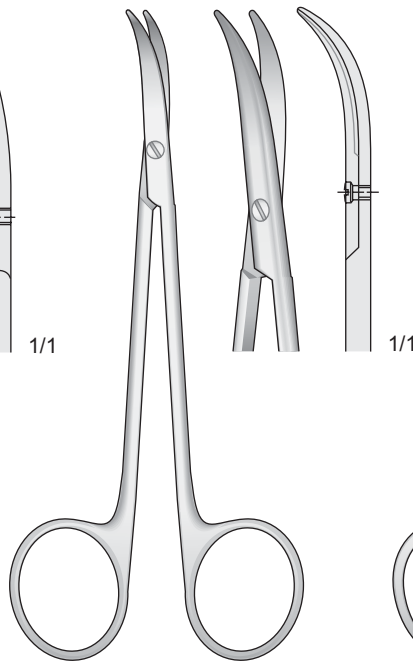

CINELLI
FG-95
115 mm

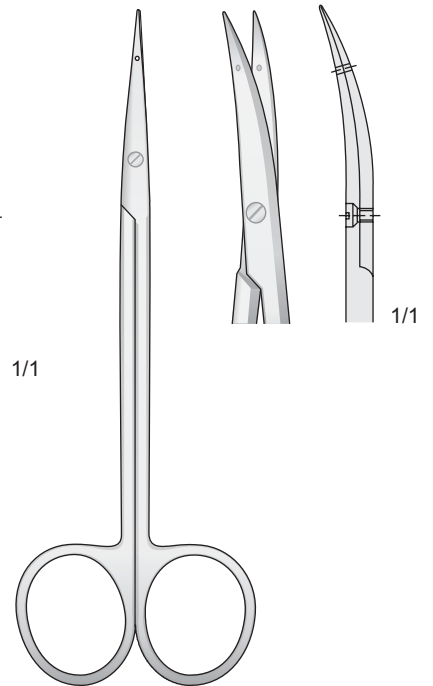

LITTLER
FG-100
120 mm

Präparierscheren - Dissecting Scissors
Forbici per dissezione - Tijeras para preparaciones - Ciseaux à dissection

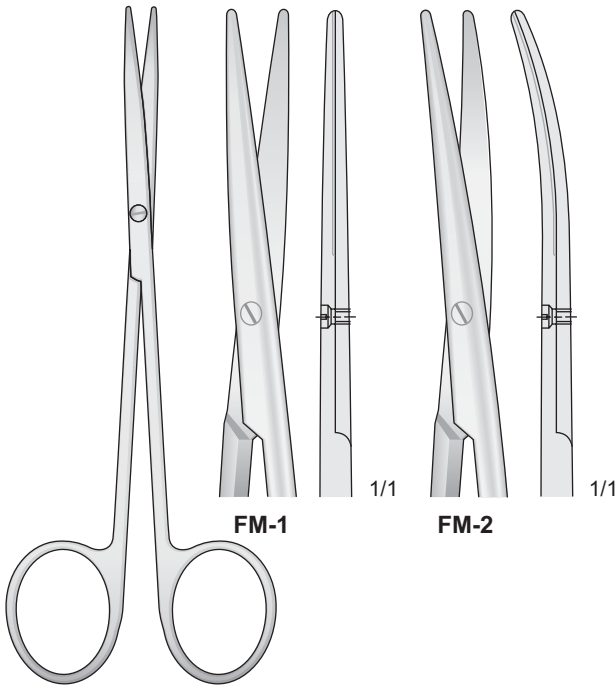

METZENBAUM
FM-1/FM-2
145 mm

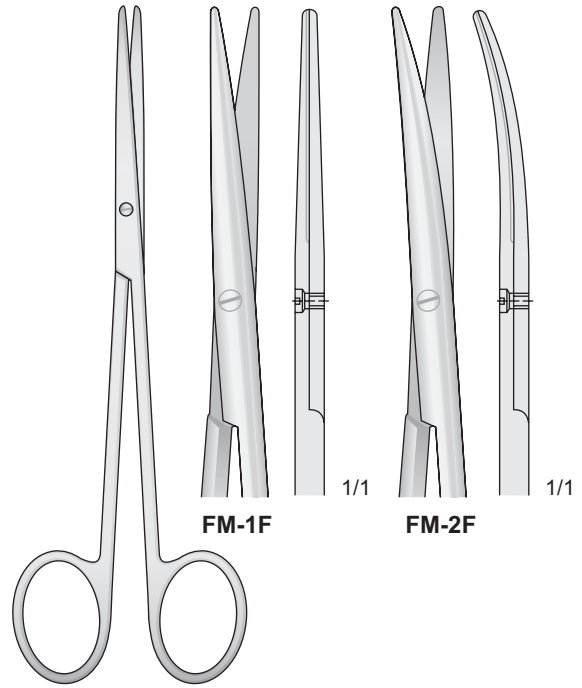

METZENBAUM-FINO
FM-1F/FM-2F
145 mm

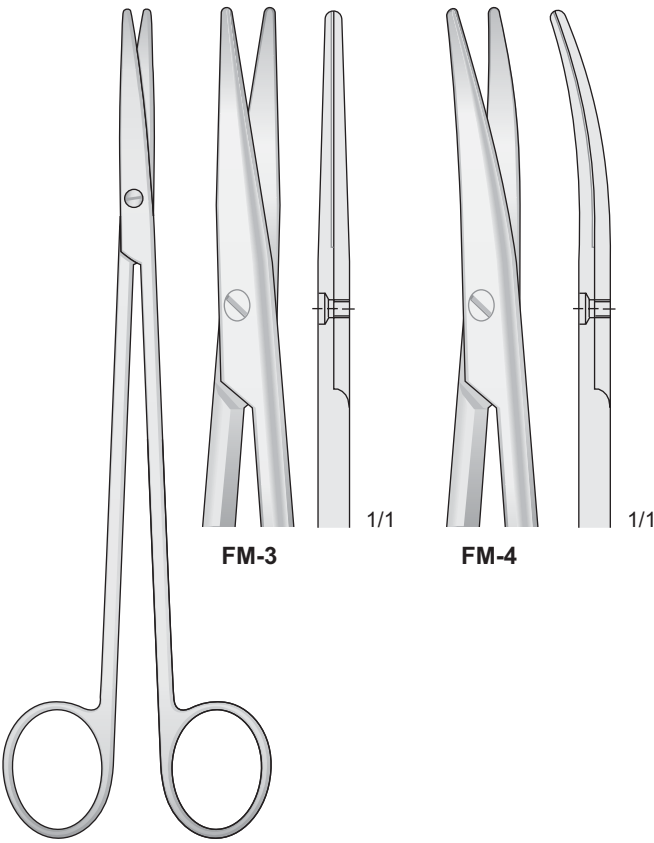

METZENBAUM
FM-3/FM-4
185 mm

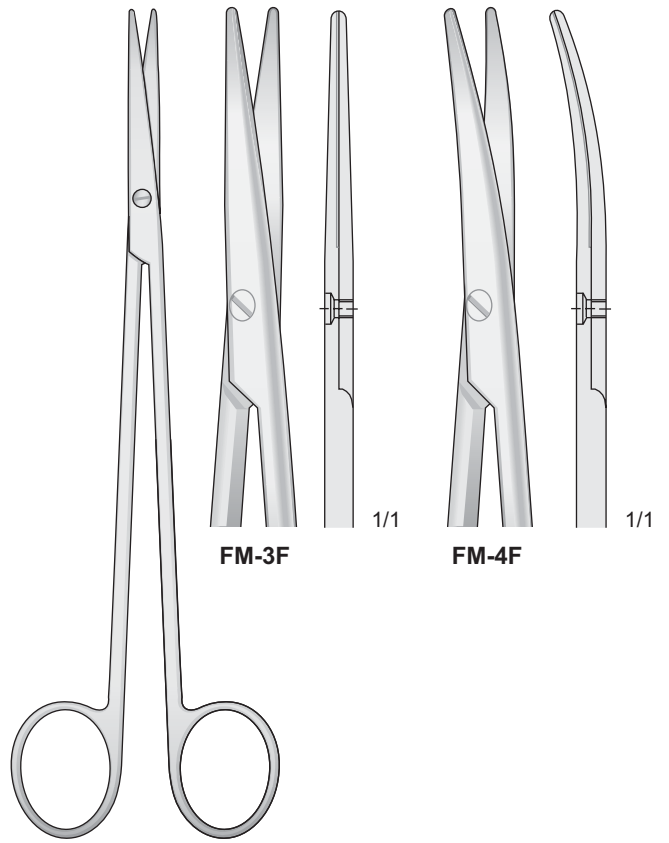

METZENBAUM-FINO
FM-3F/FM-4F
185 mm

Präparierscheren - Dissecting Scissors

Forbici per dissezione - Tijeras para preparaciones - Ciseaux à dissection

Spitz - Sharp
Acuta - Agudo - Pointu

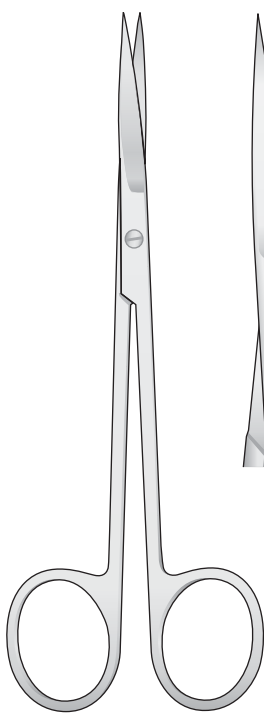

METZENBAUM
FG-14/FG-28
145 mm

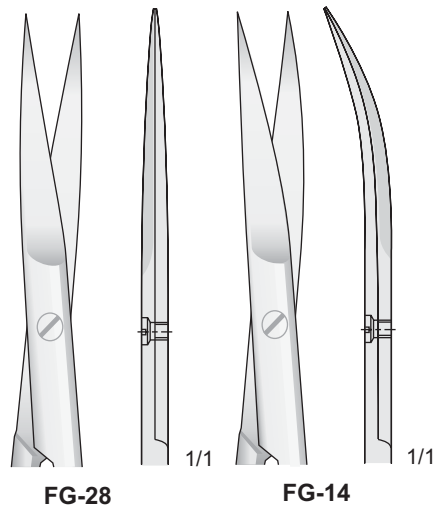

FG-28

FG-14

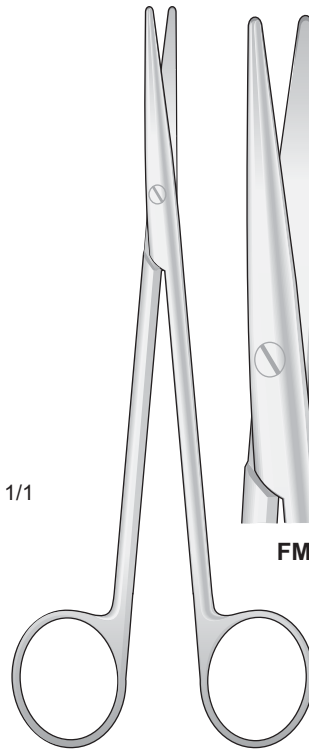

METZENBAUM
FM-74/FM-75
160 mm

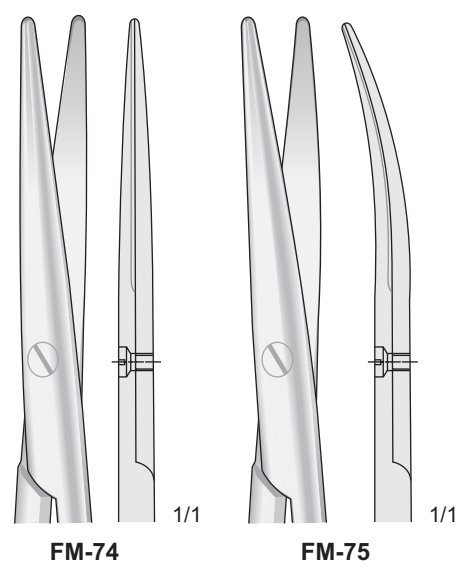

FM-74

FM-75

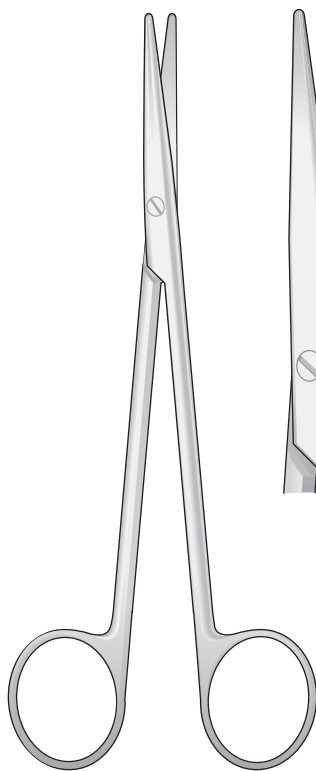

METZENBAUM
FM-70/FM-71
200 mm

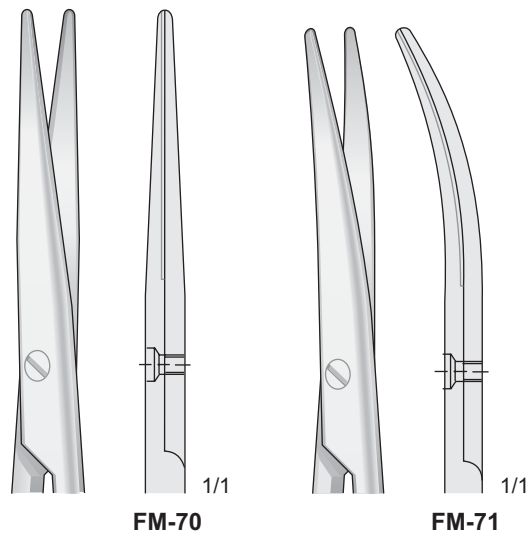

FM-70

FM-71

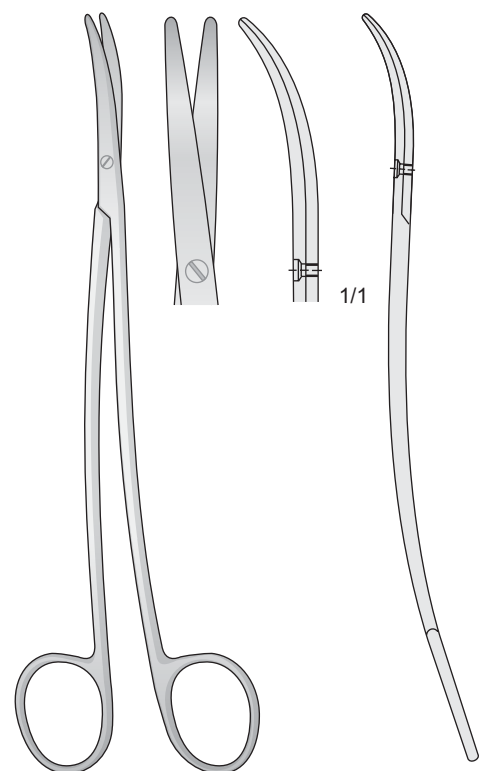

METZENBAUM-FINO
FM-120 - 180 mm
FM-121 - 200 mm
FM-122 - 230 mm

Chirurgische Scheren

Operating Scissors

Forbici chirurgiche

Tijeras para cirugía

Ciseaux chirurgicaux

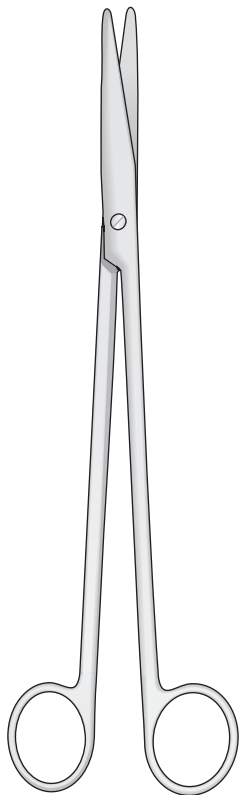

NELSON-METZENBAUM
FM-11/FM-114

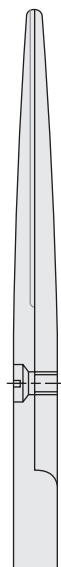
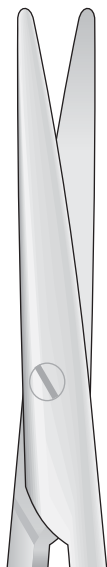

FM-11
230 mm

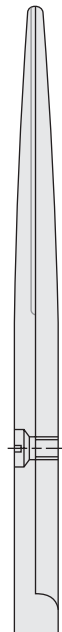

FM-112
250 mm

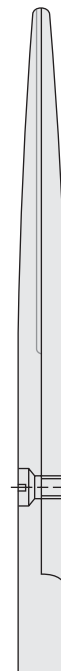

FM-113
280 mm



FM-114
305 mm

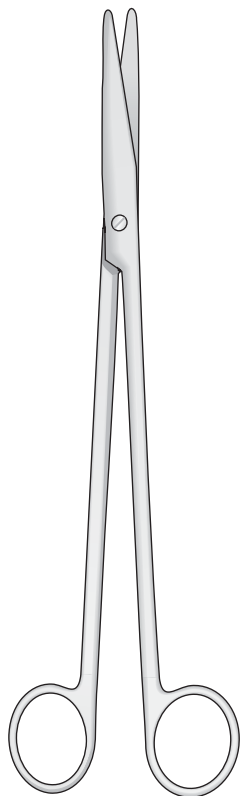

NELSON-METZENBAUM
FM-13/FM-117

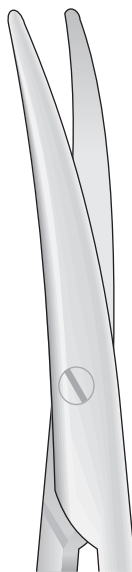

FM-13
230 mm



FM-115
250 mm



FM-116
280 mm

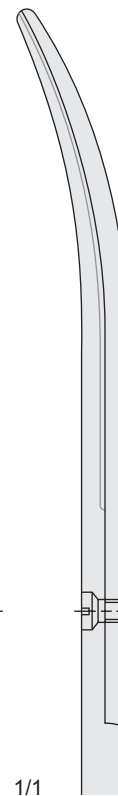

FM-117
305 mm

Chirurgische Scheren

Operating Scissors

Forbici chirurgiche

Tijeras para cirugía

Ciseaux chirurgicaux

Fein - Delicate - Fine - Finas - Fins

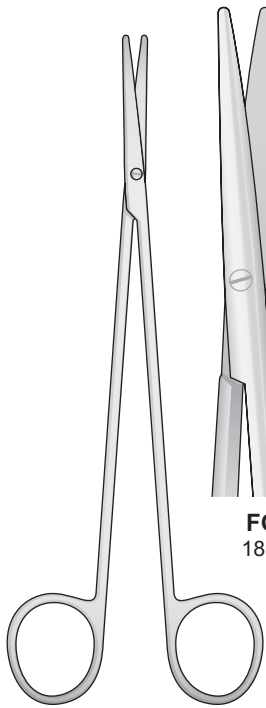

TOENNIS-ADSON
FG-60/FG-61
180 mm

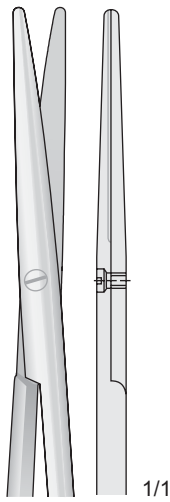

FG-60
180 mm

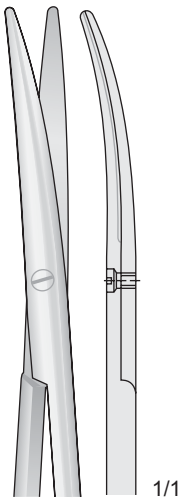

FG-61
180 mm

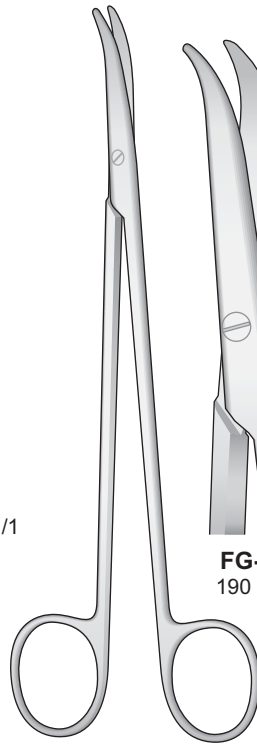

THOREK
FG-45/FG-65

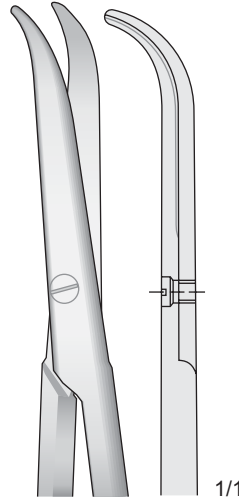

FG-45
190 mm

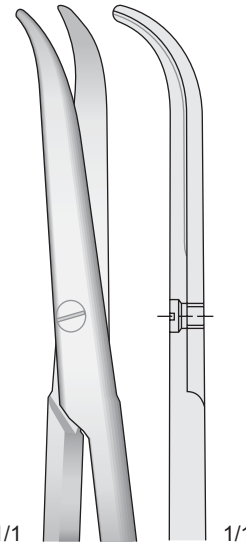

FG-46
230 mm

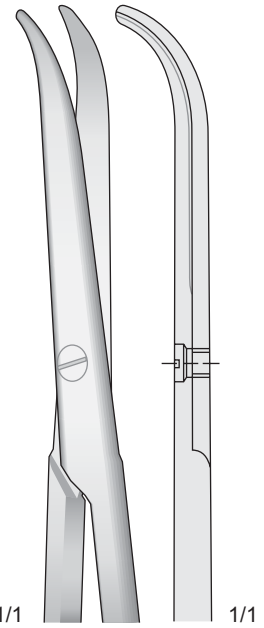

FG-65
250 mm

Fein - Delicate - Fine - Finas - Fins

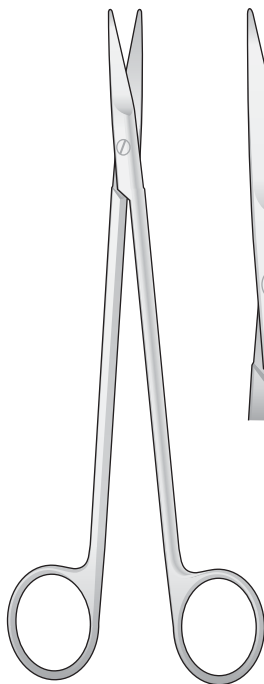

TOENNIS
FG-73/FG-75
180 mm

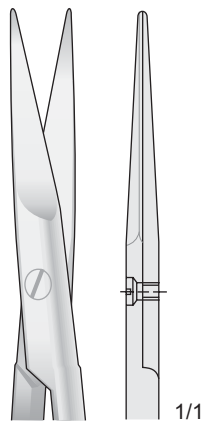

FG-73
180 mm

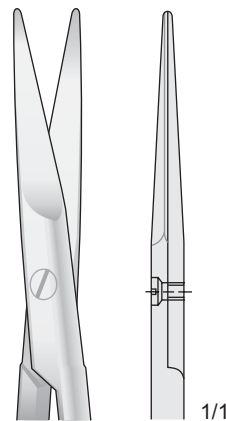

FG-74
180 mm

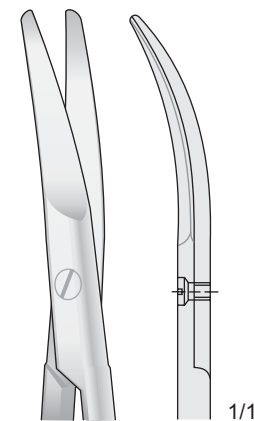

FG-75
180 mm

Präparierscheren - Dissecting scissors - Forbici per dissezione - Tijeras para preparaciones - Ciseaux à dissection

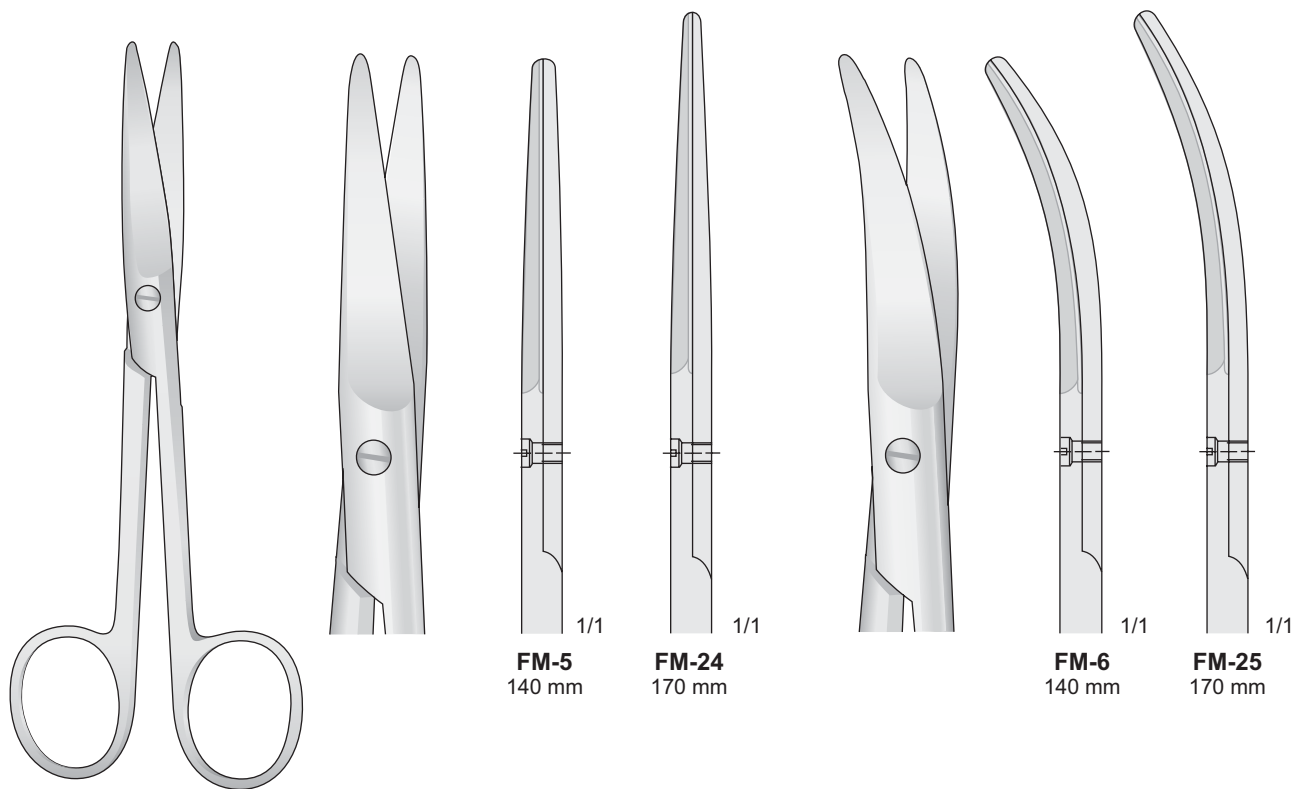

MAYO
FM-5/FM-25

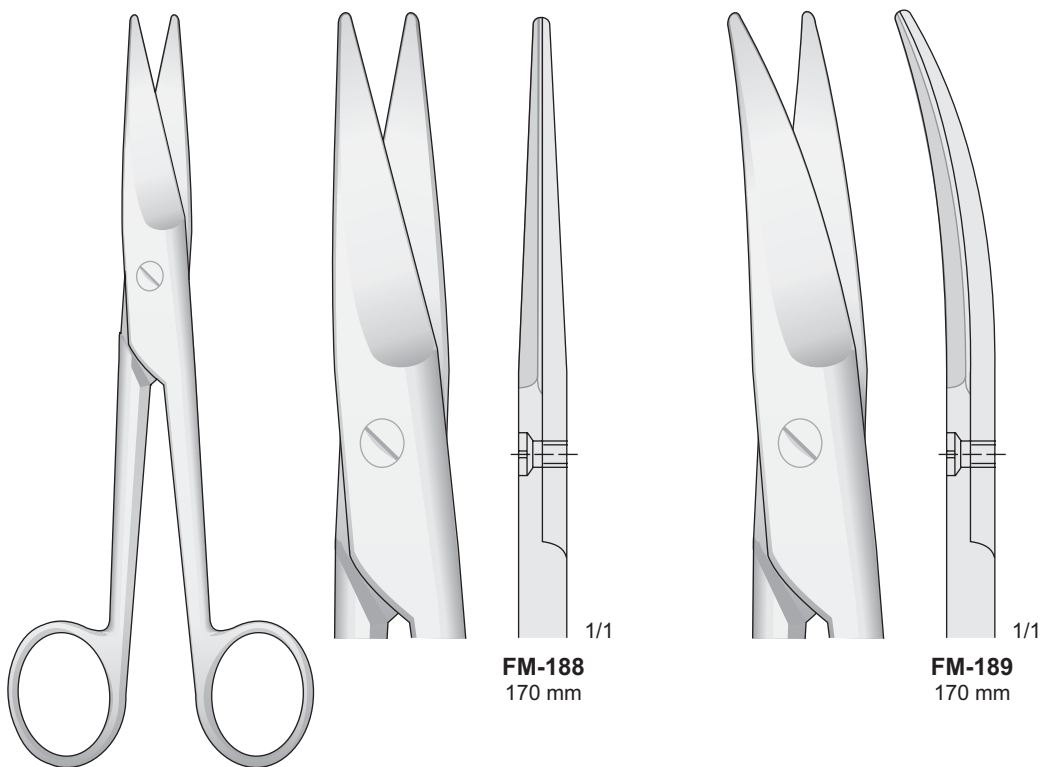

MAYO-NOBLE
FM-188/FM-189

Präparierscheren - Dissecting scissors - Forbici per dissezione - Tijeras para preparaciones - Ciseaux à dissection

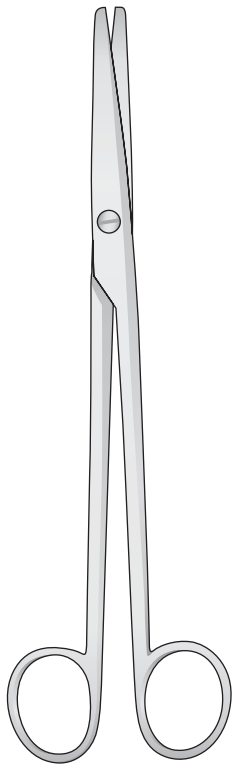

MAYO
FM-80/FM-82

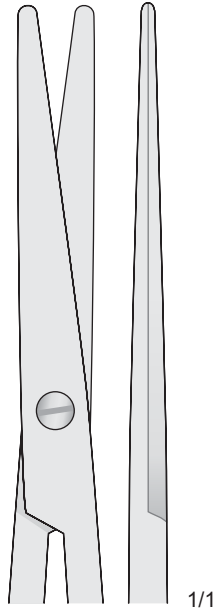

FM-80
160 mm

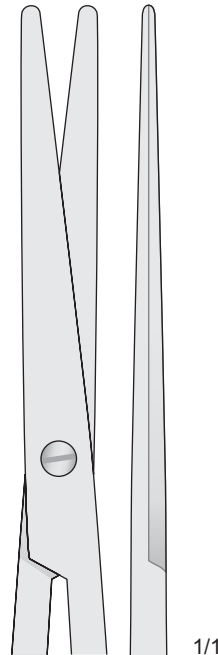

FM-81
190 mm

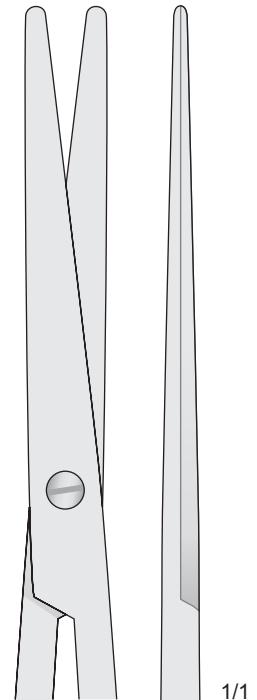

FM-82
210 mm

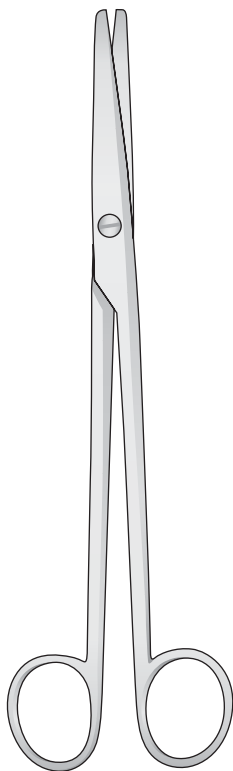

MAYO
FM-83/FM-85

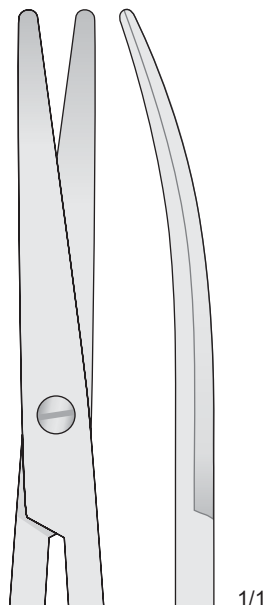

FM-83
160 mm

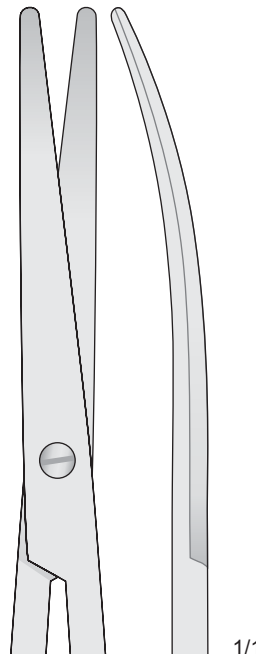

FM-84
190 mm

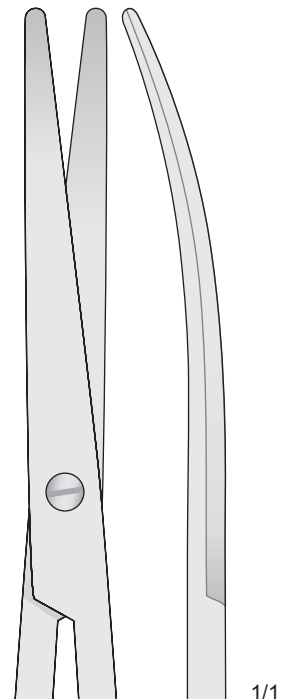

FM-85
210 mm

Fein - Delicate - Fine - Finas - Fins

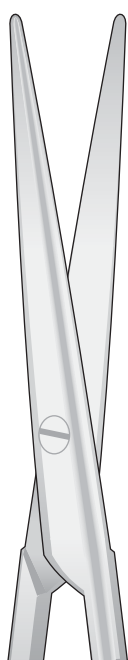
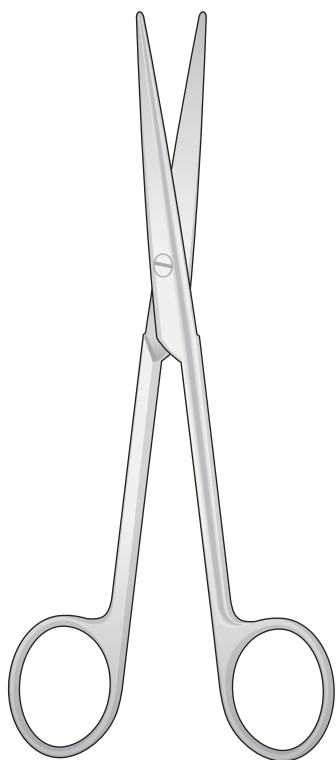

FM-180

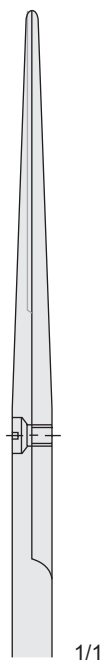

FM-181

LEXER
FM-180/181
165 mm

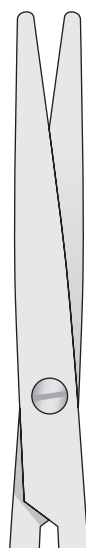
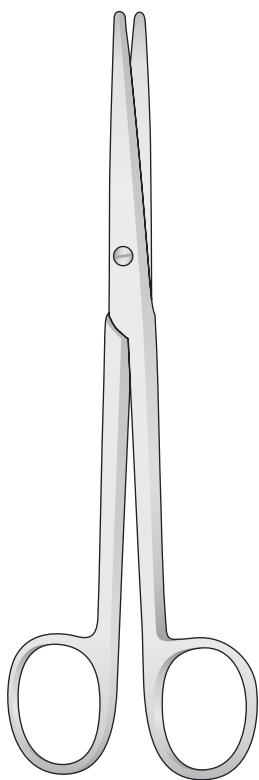

FM-86
160 mm

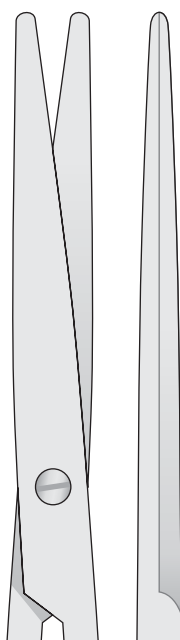

FM-87
210 mm

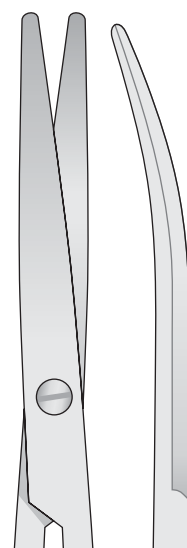

FM-88
160 mm

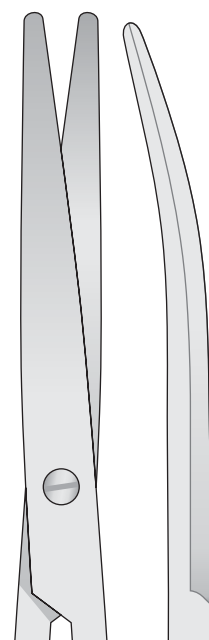

FM-89
210 mm

LEXER
FM-86/89

Präparierscheren - Dissecting Scissors - Forbici per dissezione - Tijeras para preparaciones - Ciseaux à dissection



FM-110
150 mm

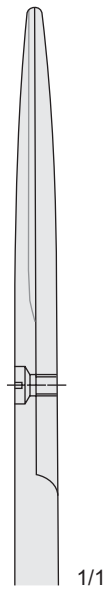

1/1



FM-111
150 mm

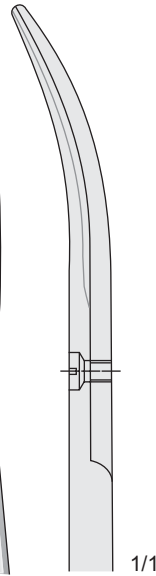

1/1

STILLE
FM-110/FM-111
150 mm

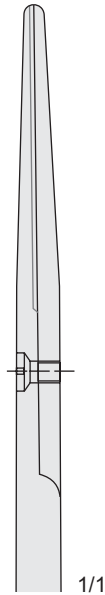
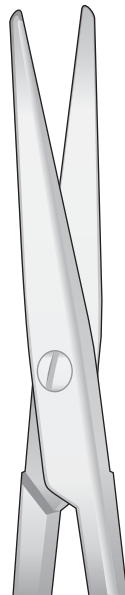
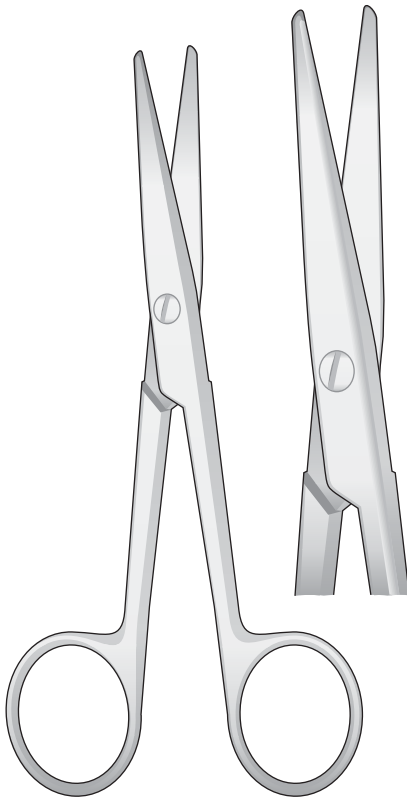

1/1

FM-76
140 mm

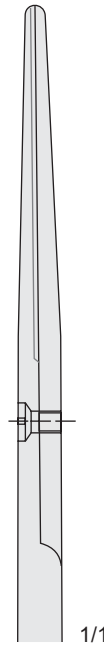

1/1

FM-77
170 mm

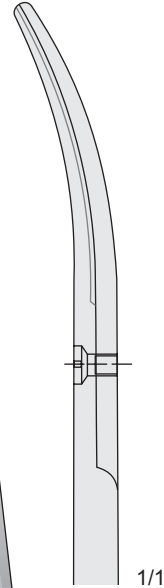
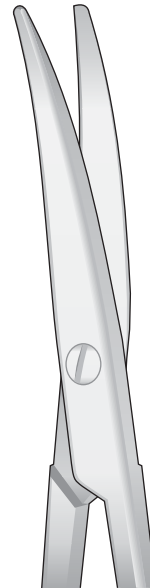

1/1

FM-78
140 mm

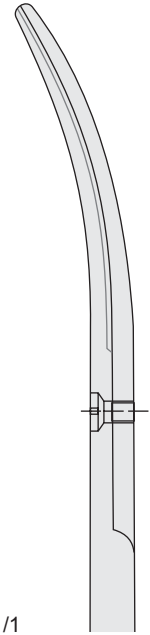

1/1

FM-79
170 mm

MAYO-STILLE
FM-76/FM-79

Präparierscheren - Bilateral Dissecting Scissors
Forbici per dissezione a taglio bilaterale - Tijeras para preparaciones - Ciseaux à dissection

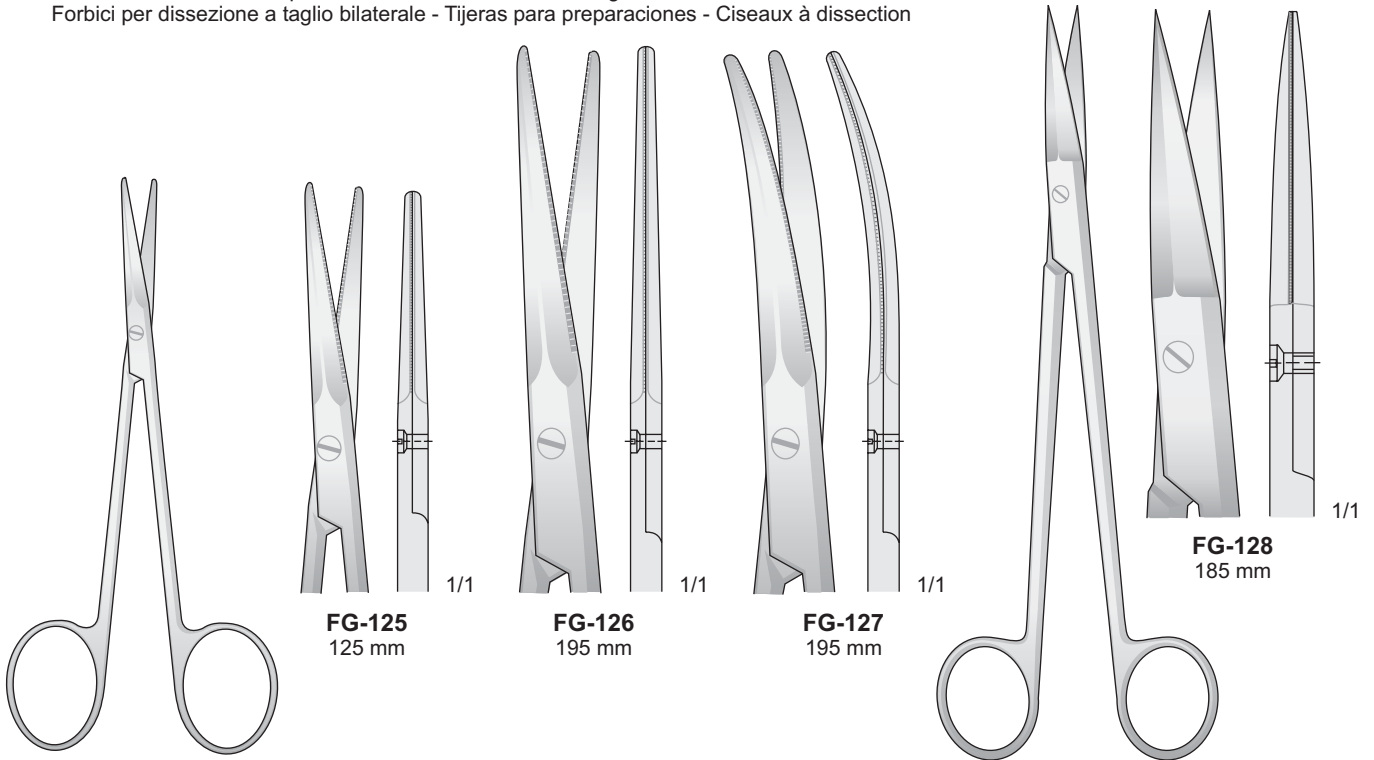

GORNEY
FG-125/FG-127

FG-128
185 mm

Präparierscheren - Bilateral Dissecting Scissors
Forbici per dissezione a taglio bilaterale - Tijeras para preparaciones - Ciseaux à dissection

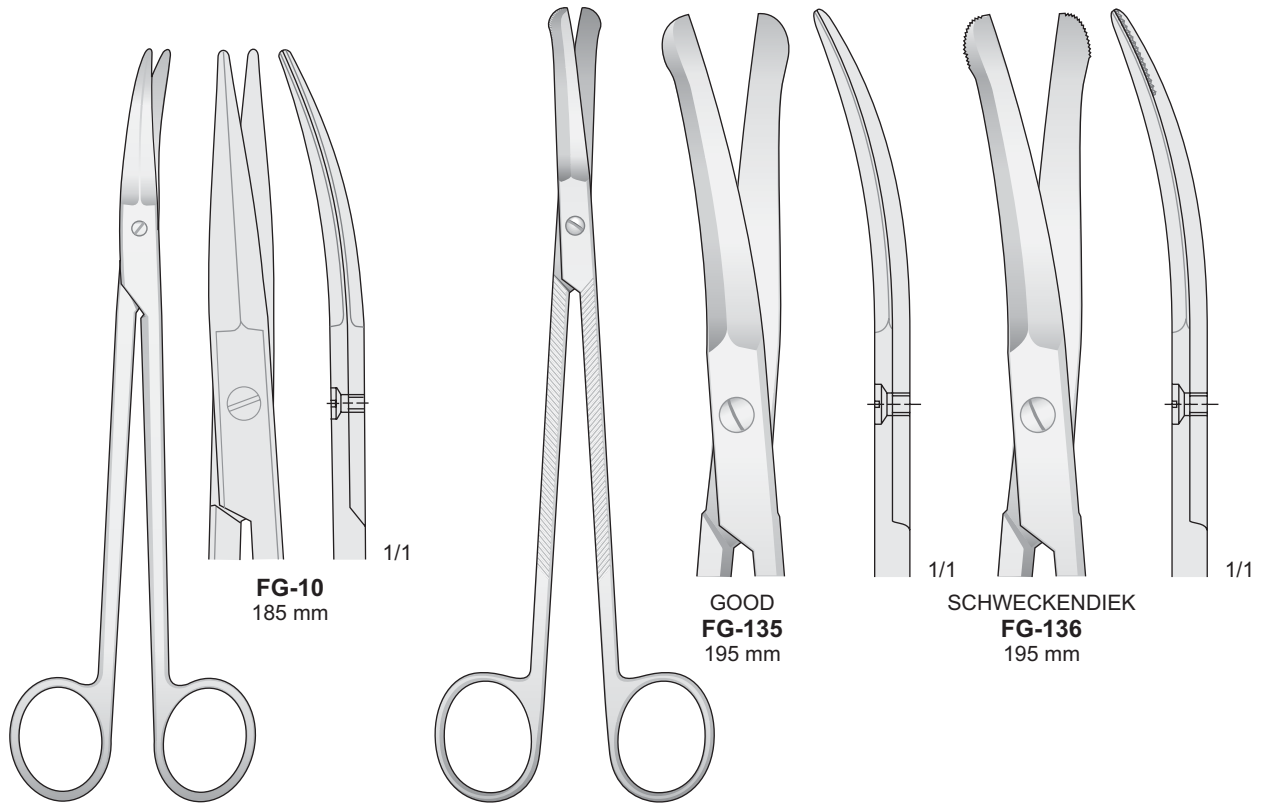

FG-10
185 mm

FG-135/FG-136
195 mm

Mit einer Schneide gezahnt - With one blade serrated
Con una lama dentellata - Con una hoja dentada
Avec une lame dentée

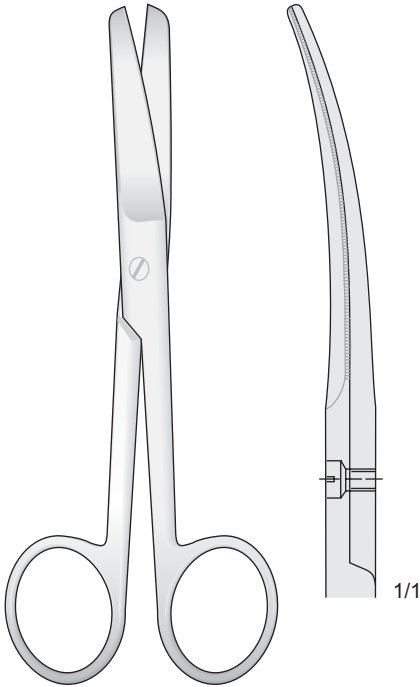

FG-116
165 mm

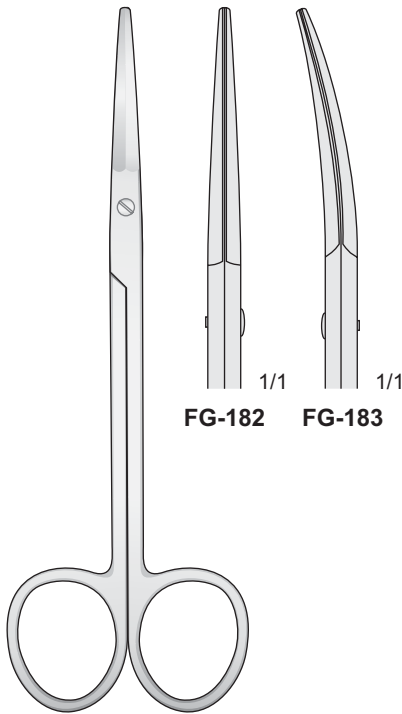

KAHN
FG-182/FG-183
145 mm

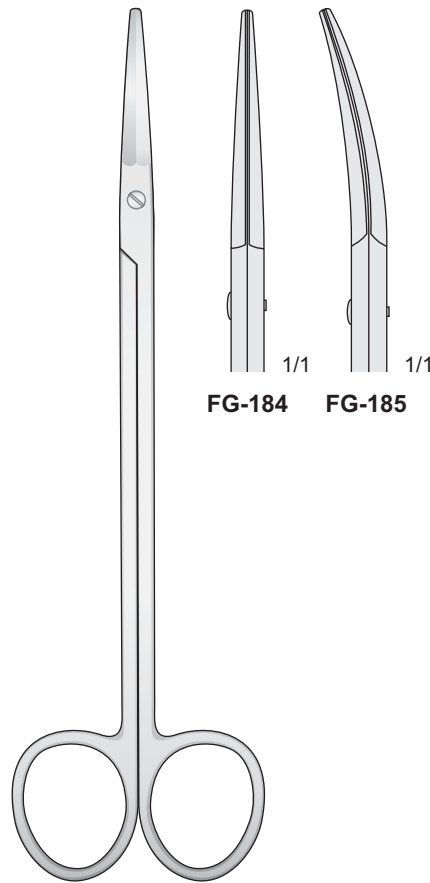

KAHN
FG-184/FG-185
180 mm

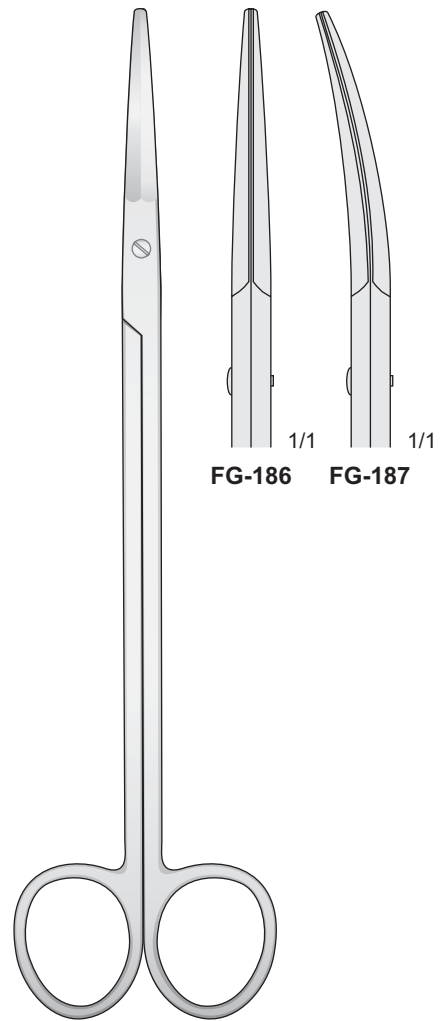

KAHN
FG-186/FG-187
205 mm

Gezahnt - Serrated - Dentellata - Dentadas - Dentelé

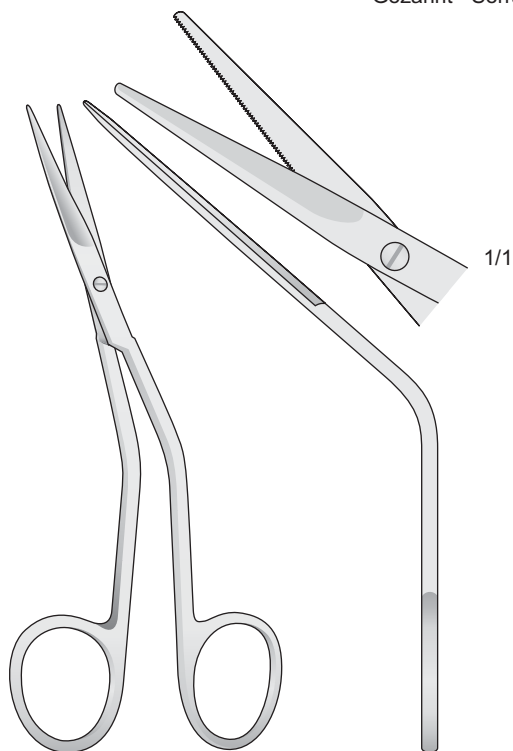

FOMON
FG-41
135 mm

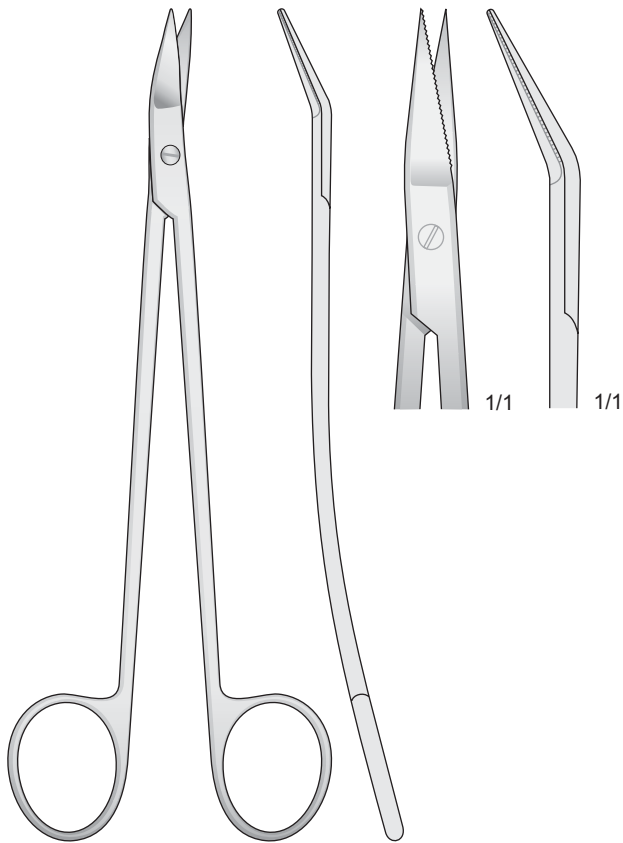

DEAN
DEAN
180 mm

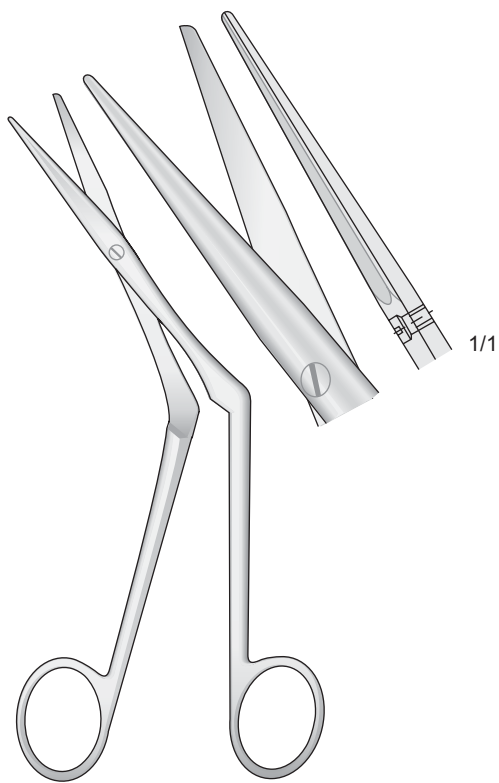

HEYMANN-KNIGHT
FG-99
175 mm

Nasenscheren - Nasal Scissors - Forbici nasali - Tijeras nasales - Ciseaux nasaux

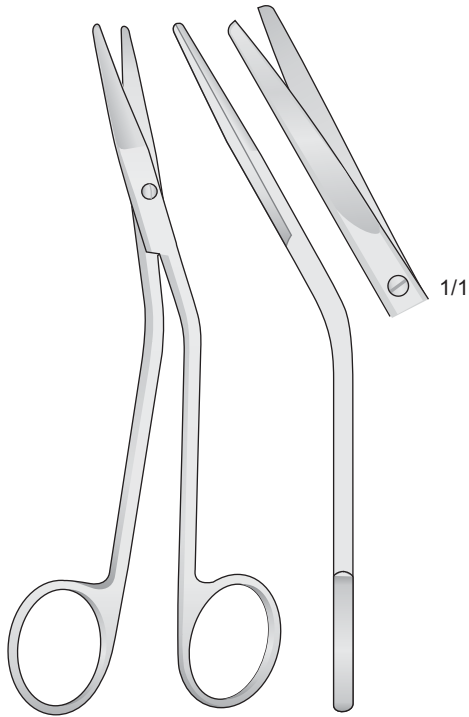

FOMON
FG-7
150 mm



HEYMANN
FG-8
180 mm

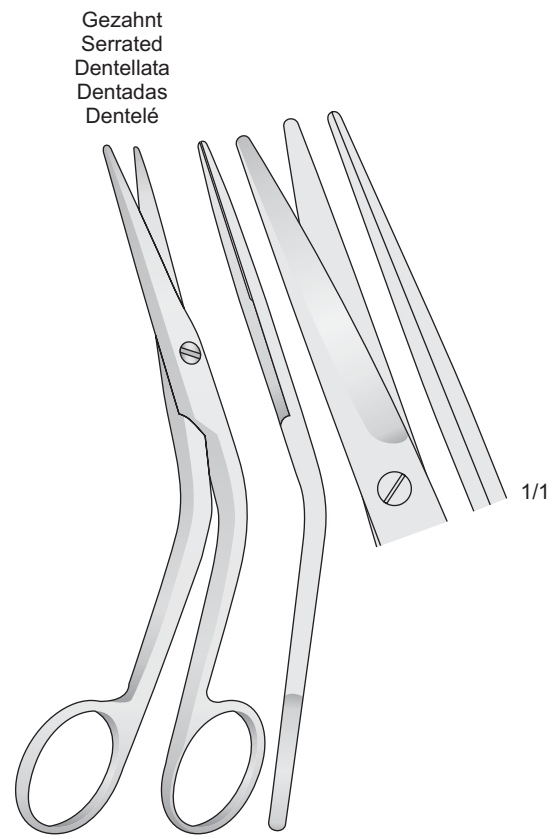

COTTLE
FG-9
160 mm

Knochensplitterscheren

Bone cutting scissors

Forbici ossivore

Tijeras para huesos

Ciseaux à os

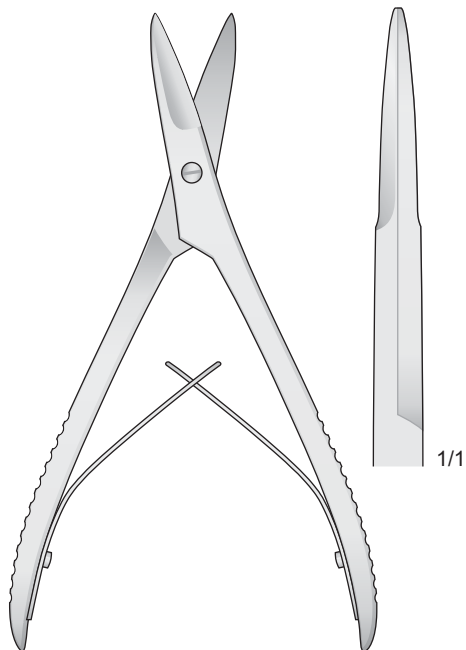

FO-63
160 mm

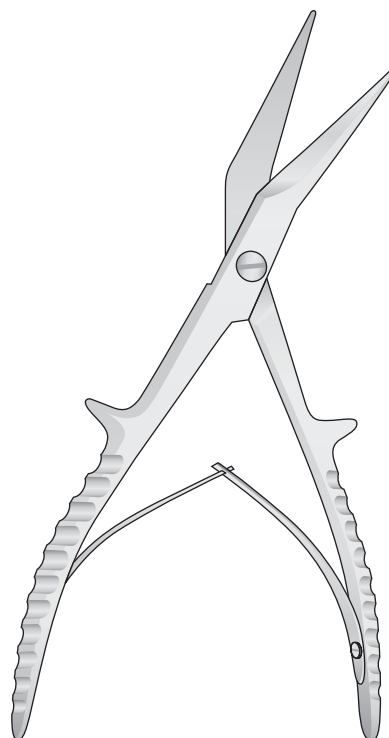

FG-110
195 mm

Gezahnt
Serrated
Dentellata
Dentadas
Dentelé

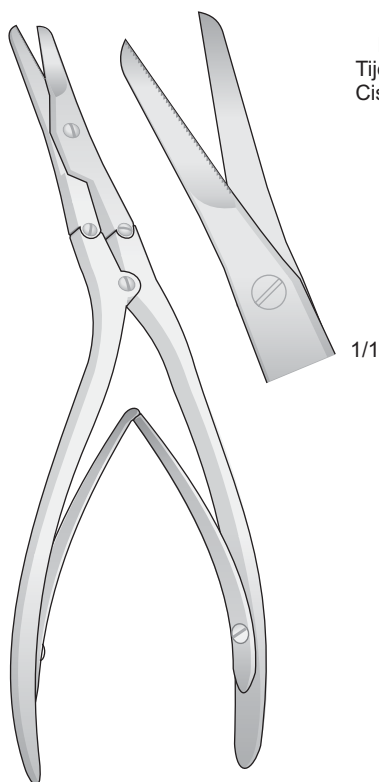

CAPLAN
FO-144
200 mm

Nasenseptumscheren
Septum Scissors
Forbici per setto nasale
Tijeras para el tabique nasal
Ciseaux pour cloison nasale

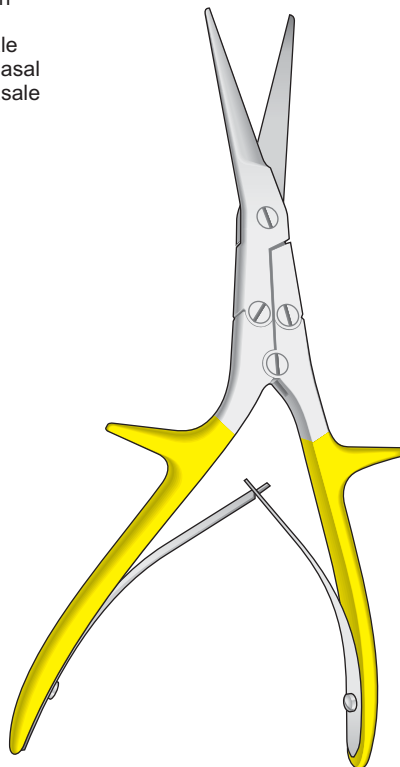

GORNEY
FO-190
205 mm

Mit einer Schneide gezahnt
With one blade serrated
Con una lama dentellata
Con una hoja dentada
Avec une lame dentée

Super Cut

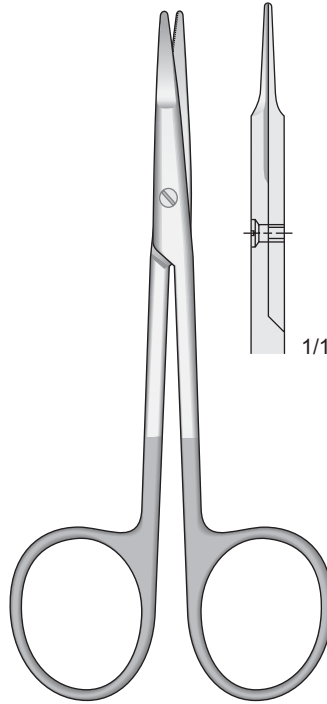

GREENBERG-PAR
FM-294
115 mm

Super Cut

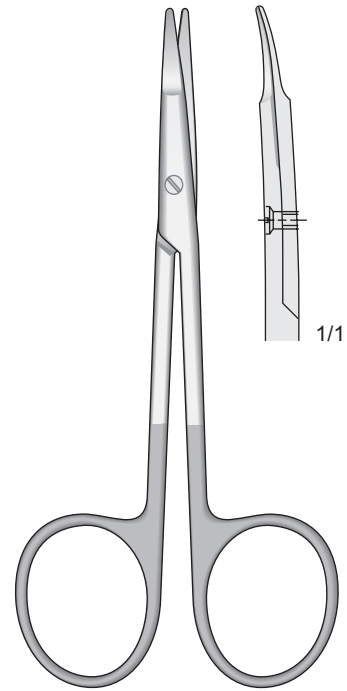

GREENBERG-PAR
FM-295
115 mm

Super Cut

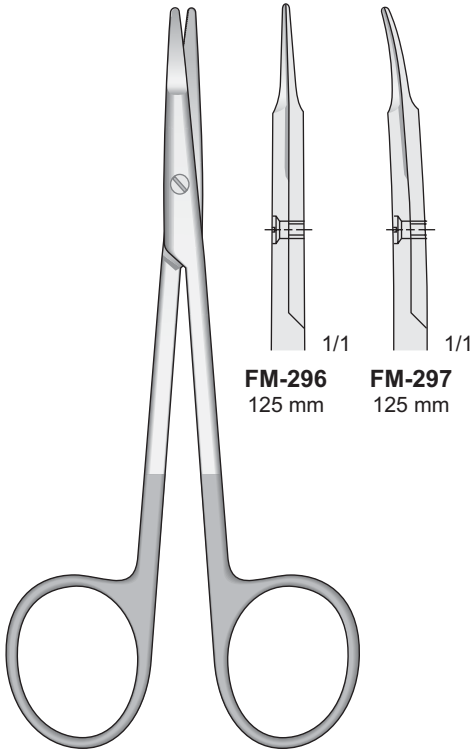

KILNER
FM-296/FM-297
125 mm

Super Cut

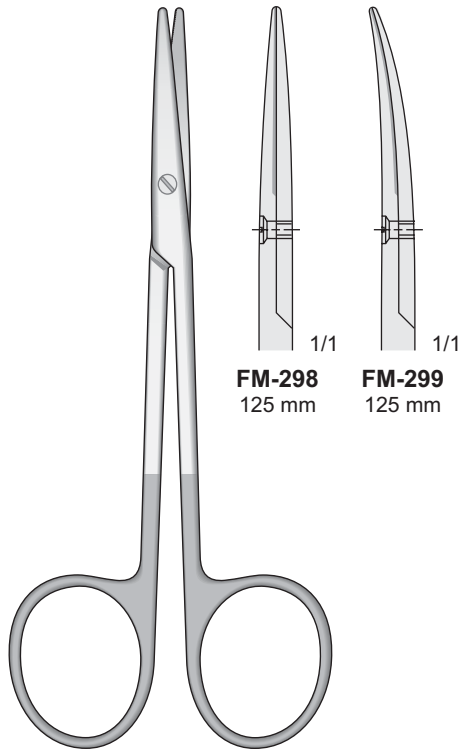

METZENBAUM
FM-298/FM-299
125 mm

Super Cut

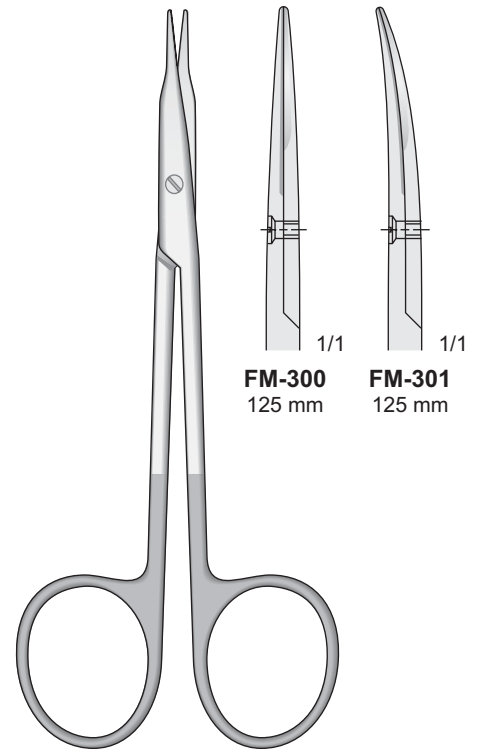

STEVENS
FM-300/FM-301
125 mm

"Super-cut" scheren micro-schliff für tissue atrauma - "Super-cut" scissors for gripping tissue and cutting interproximally
Forbici "Super-cut" estremamente taglienti per tessuti con riduzione del trauma - Tijeras "super cortes" para cortar tissue-atrauma
Ciseaux "super cut" coupe les tissus en reduisant les risques de traumatisme

Gezahnnte Scheren
Scissors Serrateds
Forbici Dentellate
Tijeras Dentada
Ciseaux Dentelé

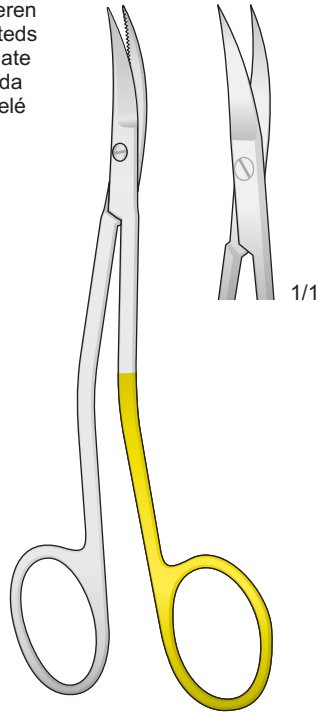

LA GRANGE
LG-1SC/LG-2SC
115 mm

Spitz
Sharp
Acute
Agudas
Pointu

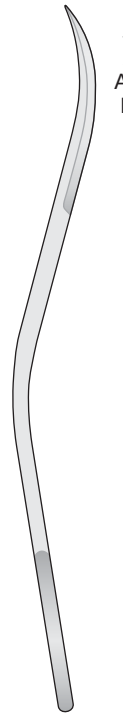

LA GRANGE
LG-1SC

Stumpf
Blunt
Smusse
Romas
Mousse

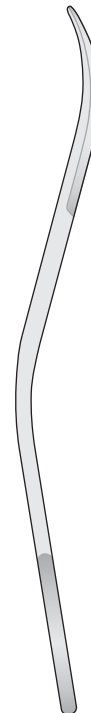

LA GRANGE
LG-2SC

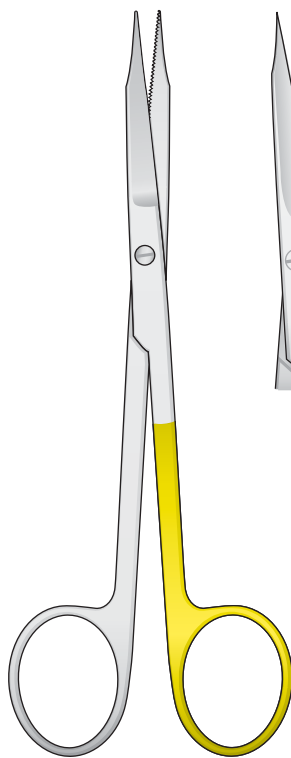

GOLDMAN-FOX
GFC-SC/GFR-SC
135 mm



GFR-SC

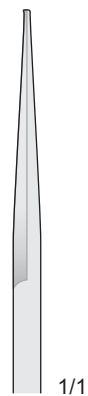

GFC-SC

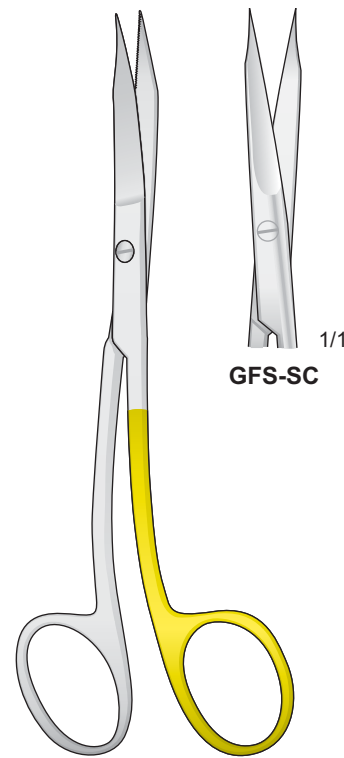

GOLDMAN-FOX
GFS-SC
130 mm



GFS-SC

S Form

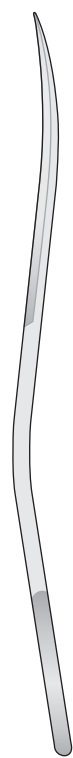

"Super-cut" scheren micro-schliff für tissue atrauma - "Super-cut" scissors for gripping tissue and cutting interproximally
Forbici "Super-cut" estremamente taglienti per tessuti con riduzione del trauma - Tijeras "super cortes" para cortar tissue-atrauma
Ciseaux "super cut" coupe les tissus en reduisant les risques de traumatisme

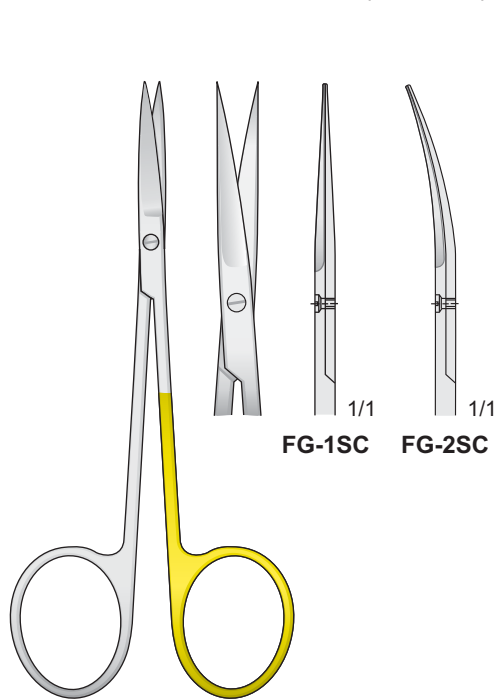

IRIS
FG-1SC/FG-2SC
110 mm

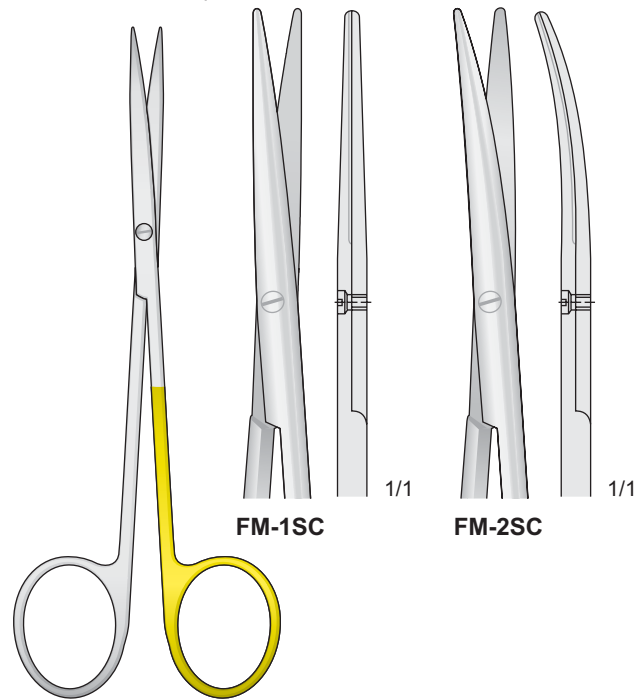

METZENBAUM
FM-1SC/FM-2SC
145 mm

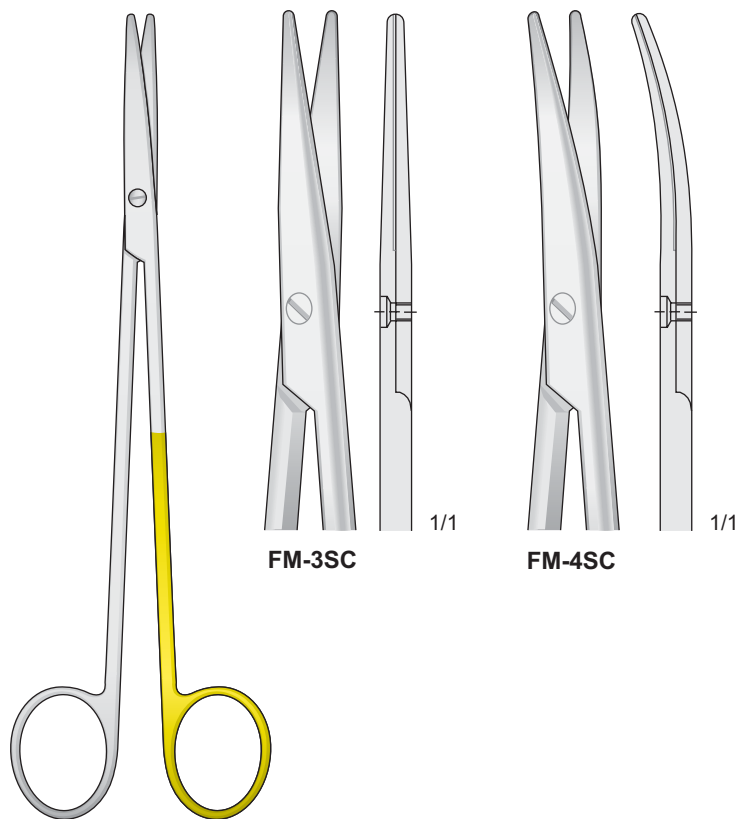

METZENBAUM
FM-3SC/FM-4SC
185 mm

"Super-cut" scheren micro-schliff für tissue atrauma - "Super-cut" scissors for gripping tissue and cutting interproximally
 Forbici "Super-cut" estremamente taglienti per tessuti con riduzione del trauma - Tijeras "super cortes" para cortar tissue-atrauma
 Ciseaux "super cut" coupe les tissus en réduisant les risques de traumatisme

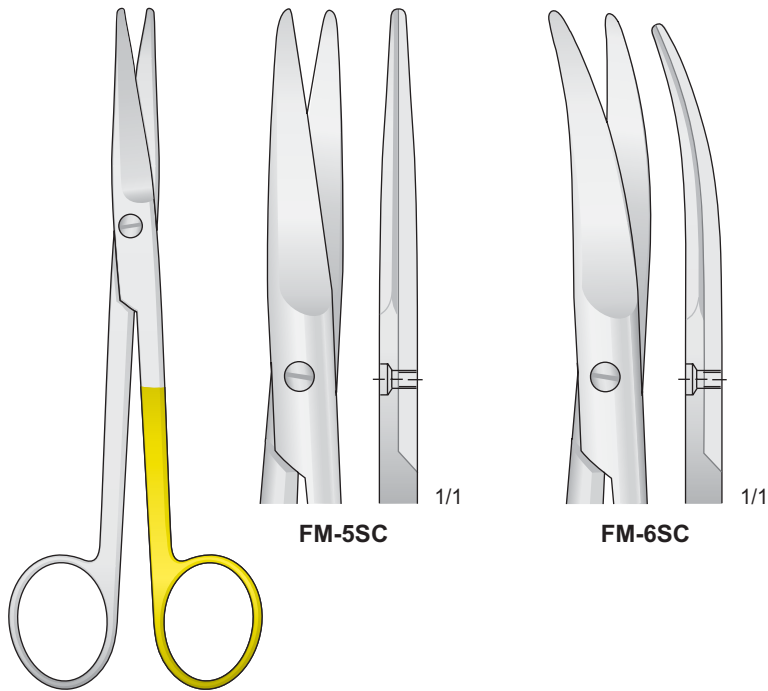

MAYO
FM-5SC/FM-6SC
 140 mm



MAYO
FM-24SC/FM25SC
 170 mm

FM-29SC/FM30SC
 145 mm

Links Scheren

Left scissors

Forbici per mancini

Tijeras para zurdos

Gauche Ciseaux

L = links
left
mancini
izquierda
gauche

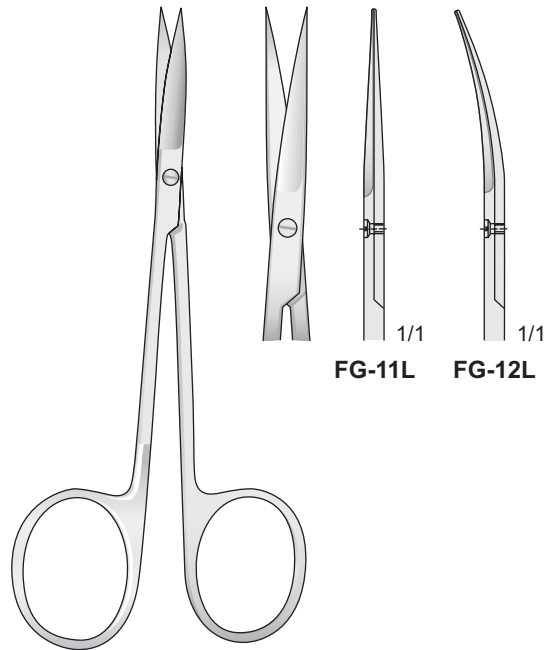

IRIS
FG-11L/FG-12L
110 mm

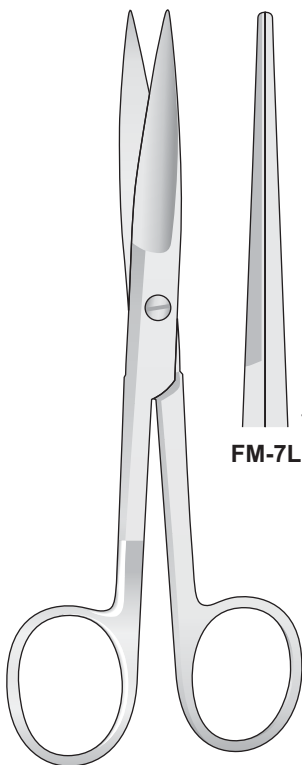

FM-7L/FM-8L
145 mm

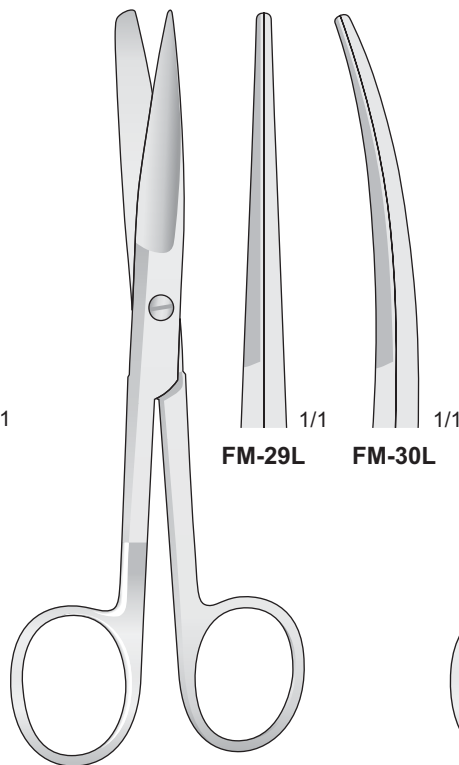

FM-29L/FM-30L
145 mm

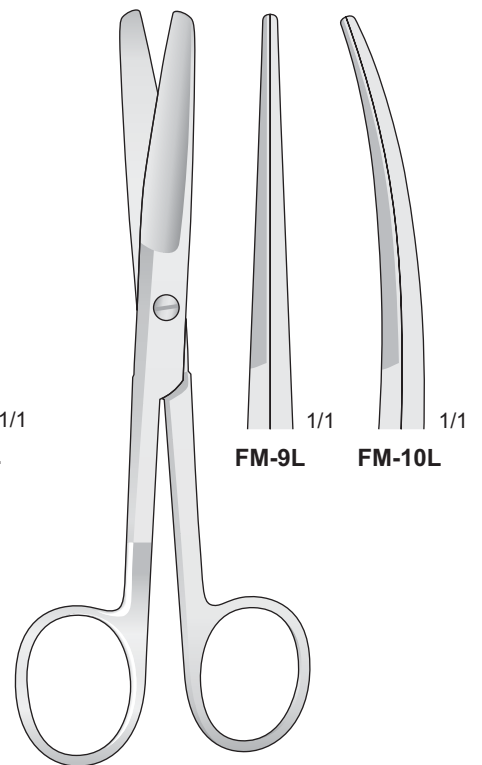

FM-9L/FM-10L
145 mm

Mit Hartmetalleinsätzen - Tungsten-carbide scissors
Con punta al carburo di tungsteno - Tijeras de tungsteno - Avec plaquettes en carbure de tungstène

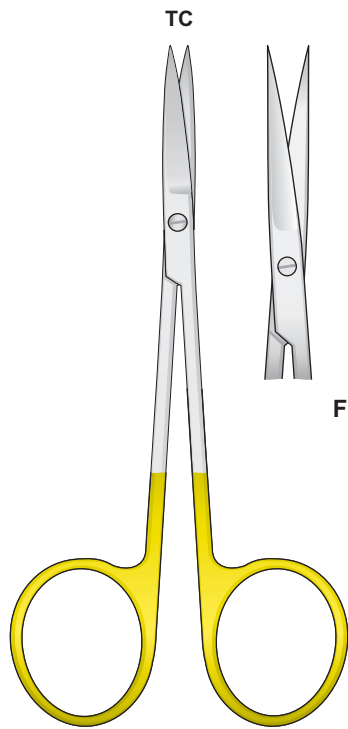

IRIS
FG1-TC/FG2-TC
115 mm

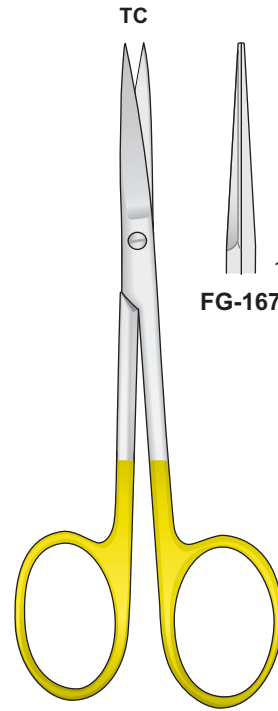
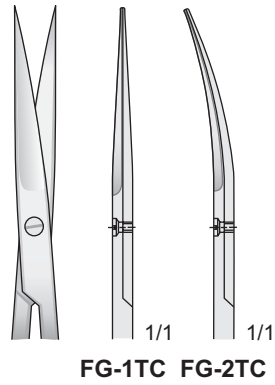

FG-167/FG-168
110 mm

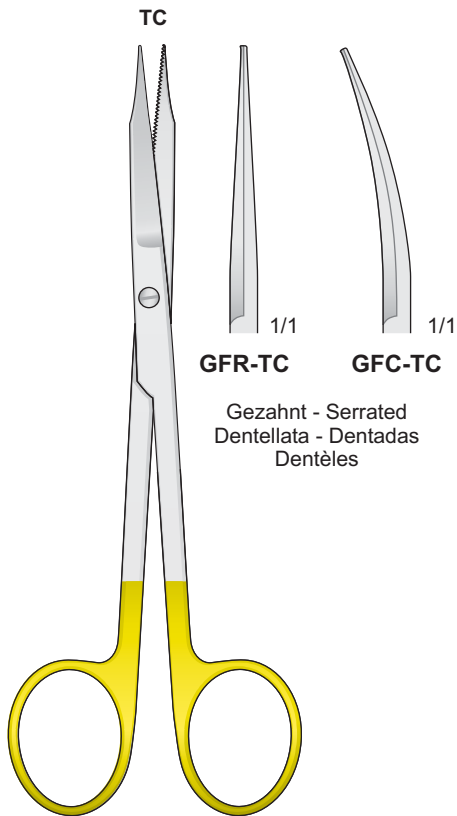
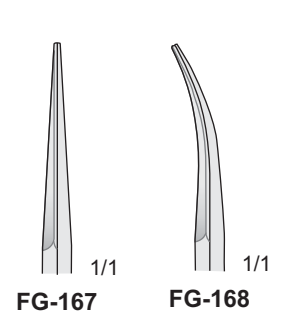

GOLDMAN-FOX
GFC-TC/GFR-TC
135 mm

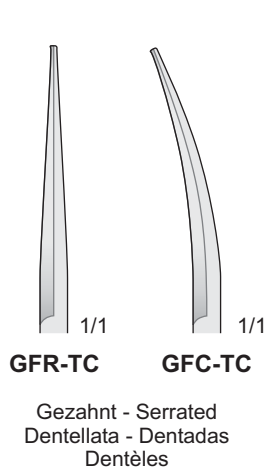

Gezähnt - Serrated
Dentellata - Dentadas
Dentées

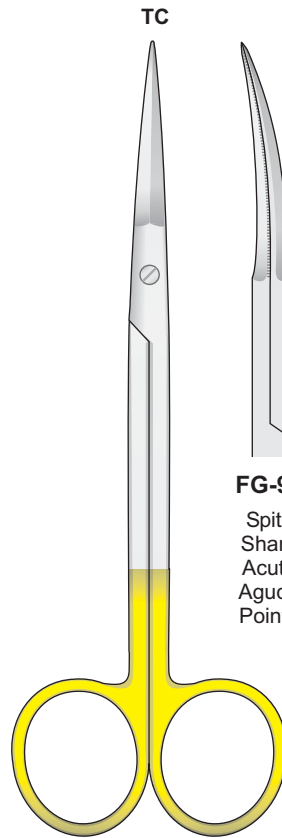

PECK-JOSEPH
FG-92/FG-98
140 mm

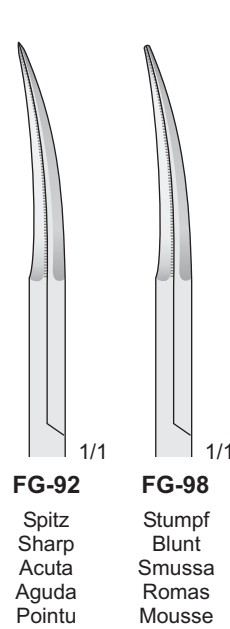

FG-92 Spitz
Sharp
Acuta
Aguda
Pointu

FG-98 Stumpf
Blunt
Smussa
Romas
Mousse

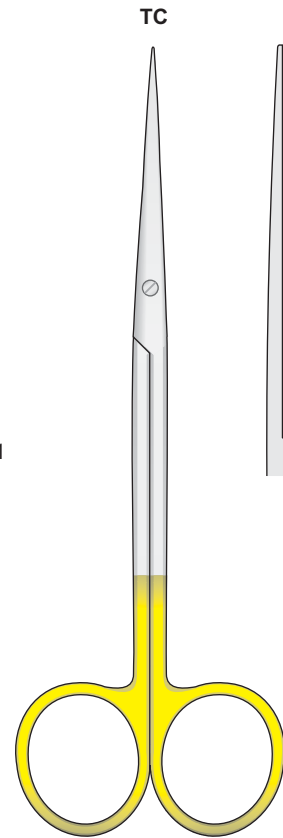

METZENBAUM-FINO
FM-96
140 mm

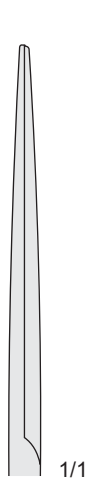

Mit Hartmetalleinsätzen - Tungsten-carbide scissors
Con punta al carburo di tungsteno - Tijeras de tungsteno - Avec plaquettes en carbure de tungstène

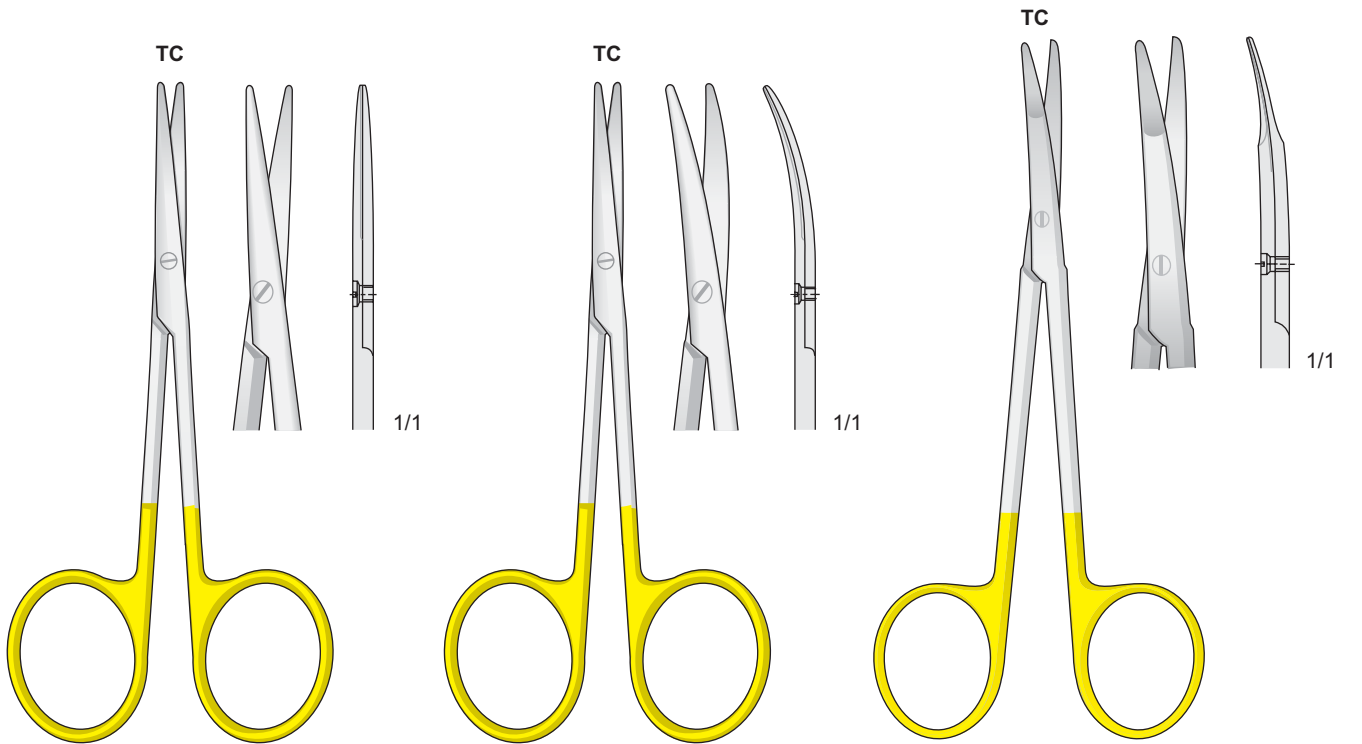

FM-118
115 mm

FM-119
115 mm

KILNER (RAGNELL)
FM-350
125 mm

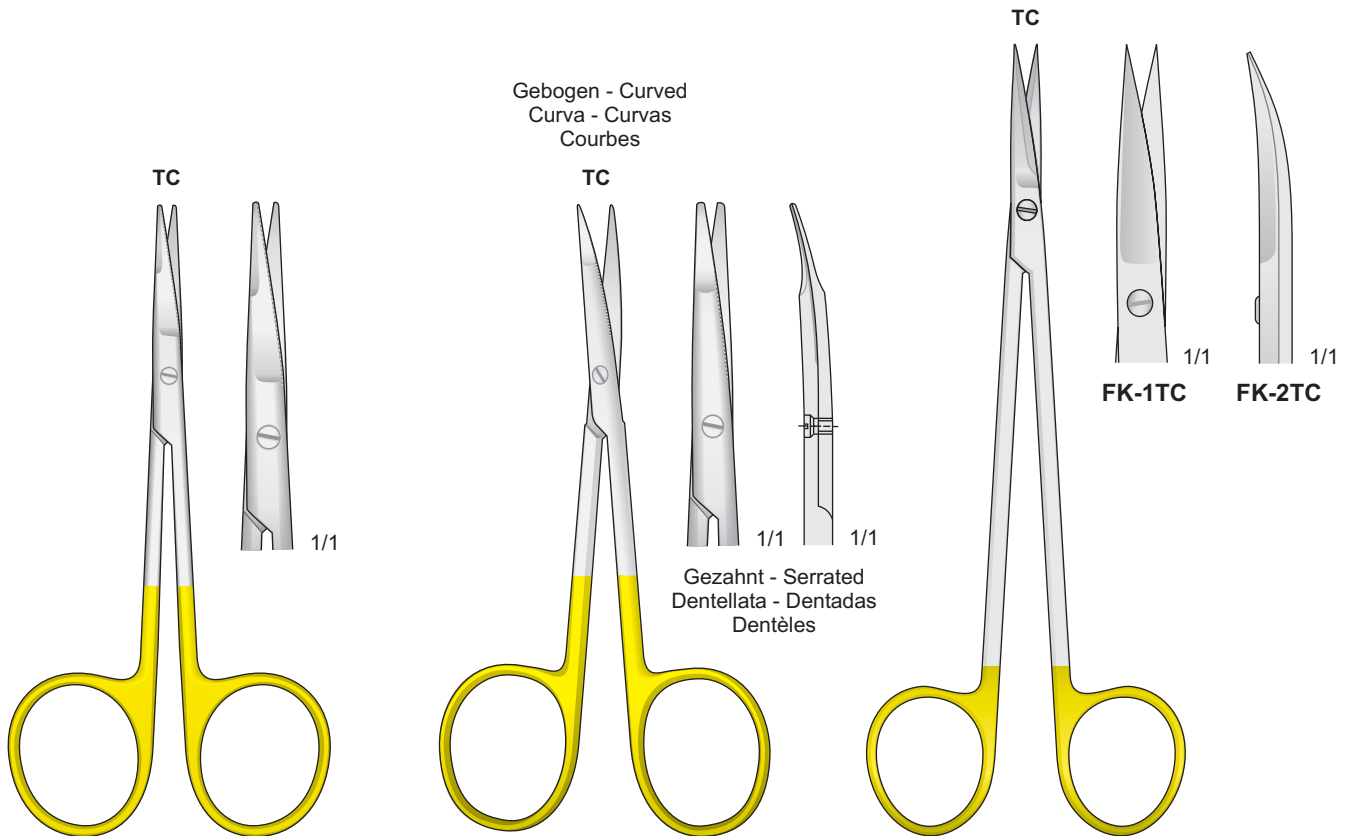

PAR-TYPE
FM-316
115 mm

GREENBERG-PAR
FM-317
115 mm

KELLY
FK-1TC/FK-2TC
160 mm

Mit Hartmetalleinsätzen - Tungsten-carbide scissors
Con punta al carburo di tungsteno - Tijeras de tungsteno - Avec plaquettes en carbure de tungstène

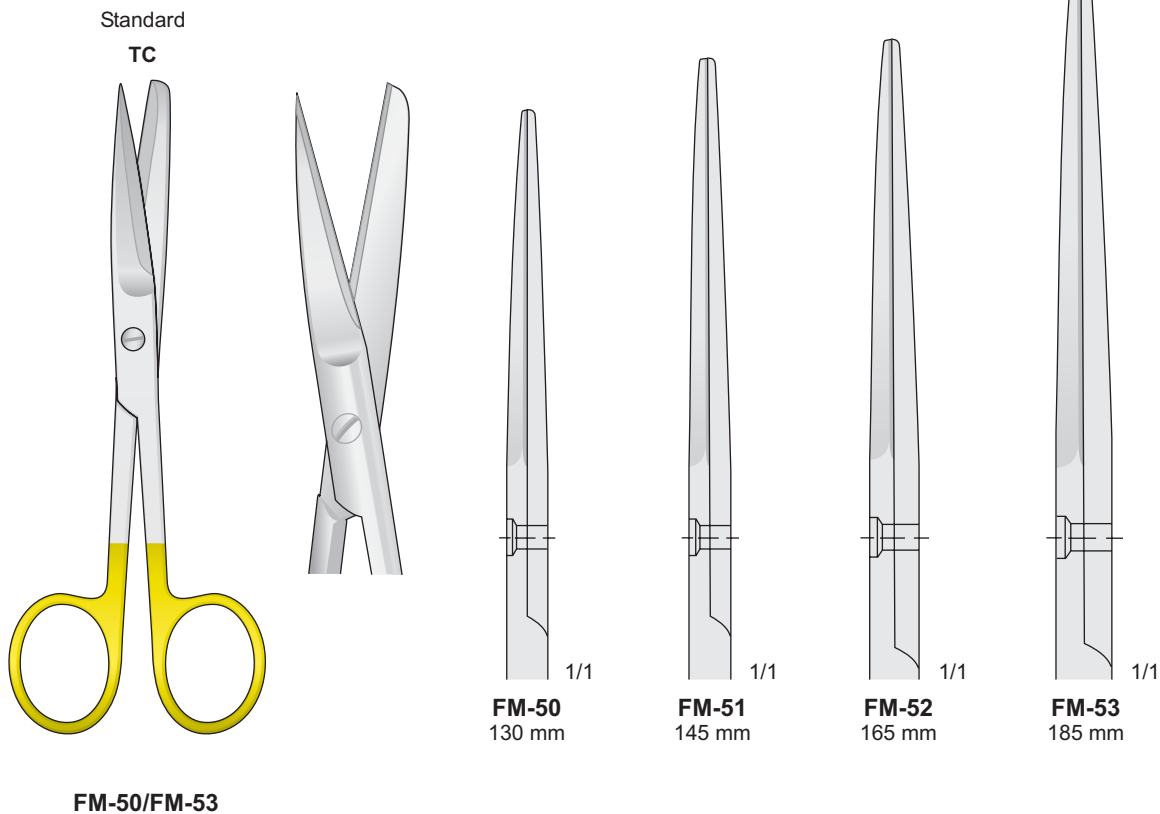

Mit Hartmetalleinsätzen - Tungsten-carbide scissors
Con punta al carburo di tungsteno - Tijeras de tungsteno - Avec plaquettes en carbure de tungstène

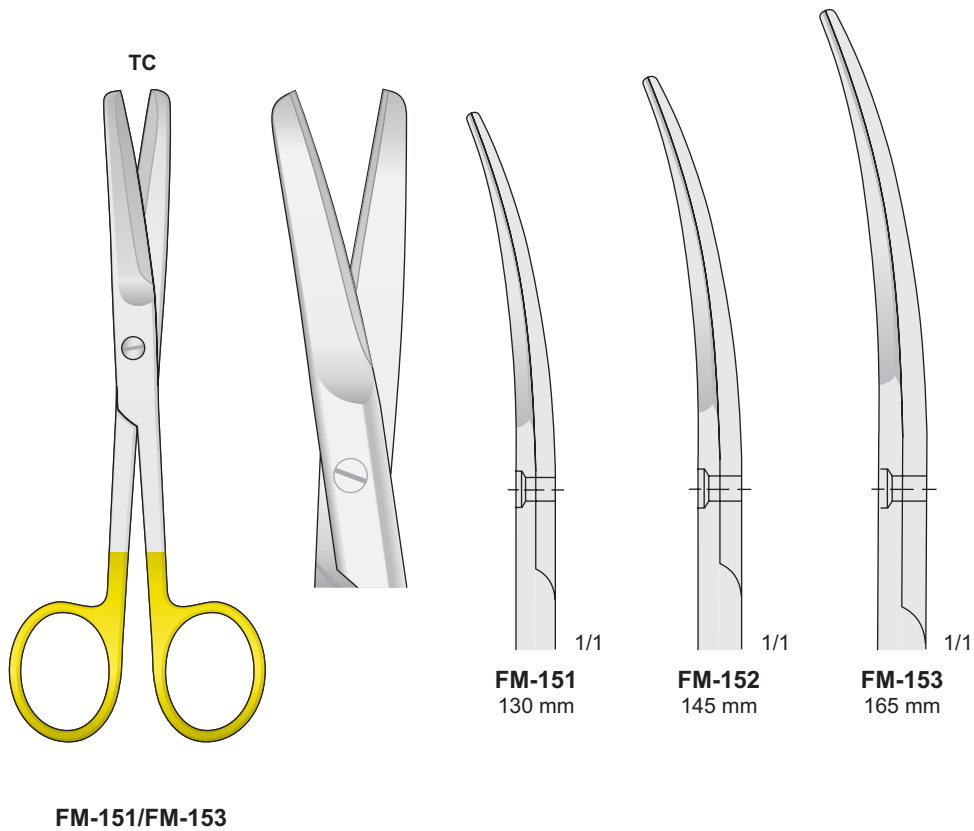
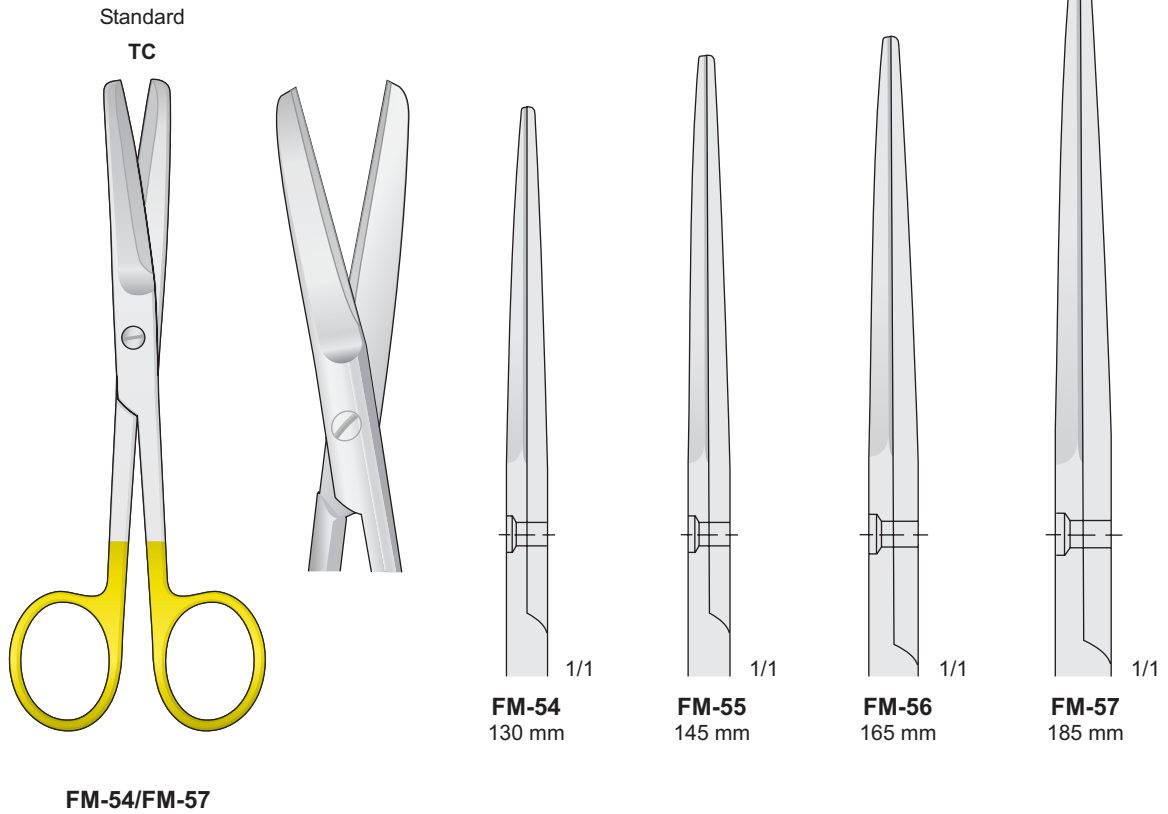

Mit Hartmetalleinsätzen - Tungsten-carbide scissors
Con punta al carburo di tungsteno - Tijeras de tungsteno - Avec plaquettes en carbure de tungstène

Standard
TC



FM-58
130 mm



FM-59
145 mm

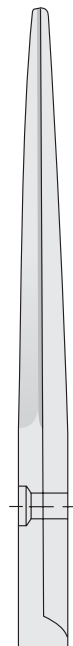

FM-60
165 mm

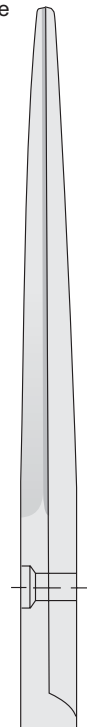

FM-61
185 mm

FM-58/FM-61

TC



FM-145
130 mm



FM-146
145 mm



FM-147
165 mm

FM-145/FM-147

Mit Hartmetalleinsätzen - Tungsten-carbide scissors
Con punta al carburo di tungsteno - Tijeras de tungsteno - Avec plaquettes en carbure de tungstène

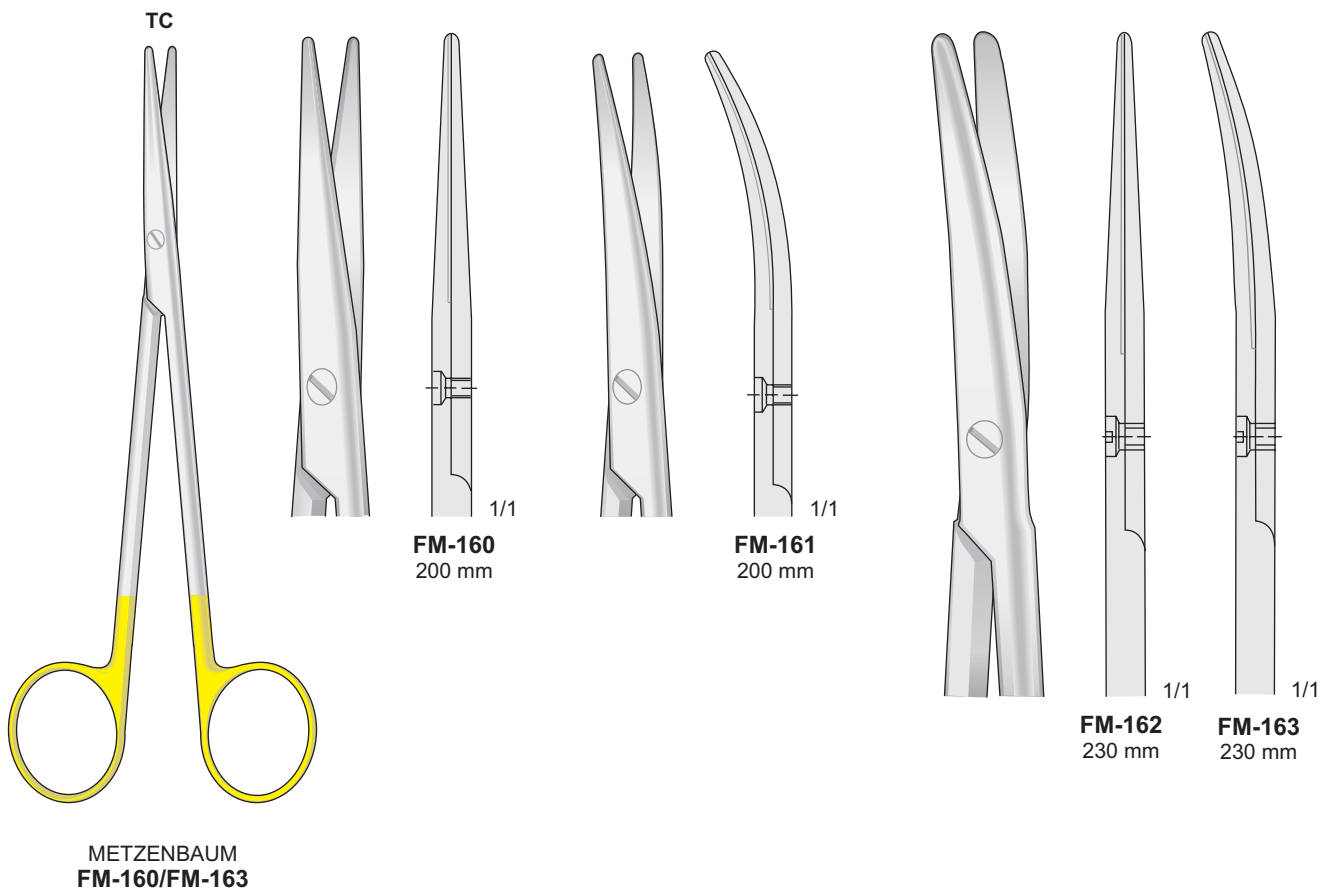
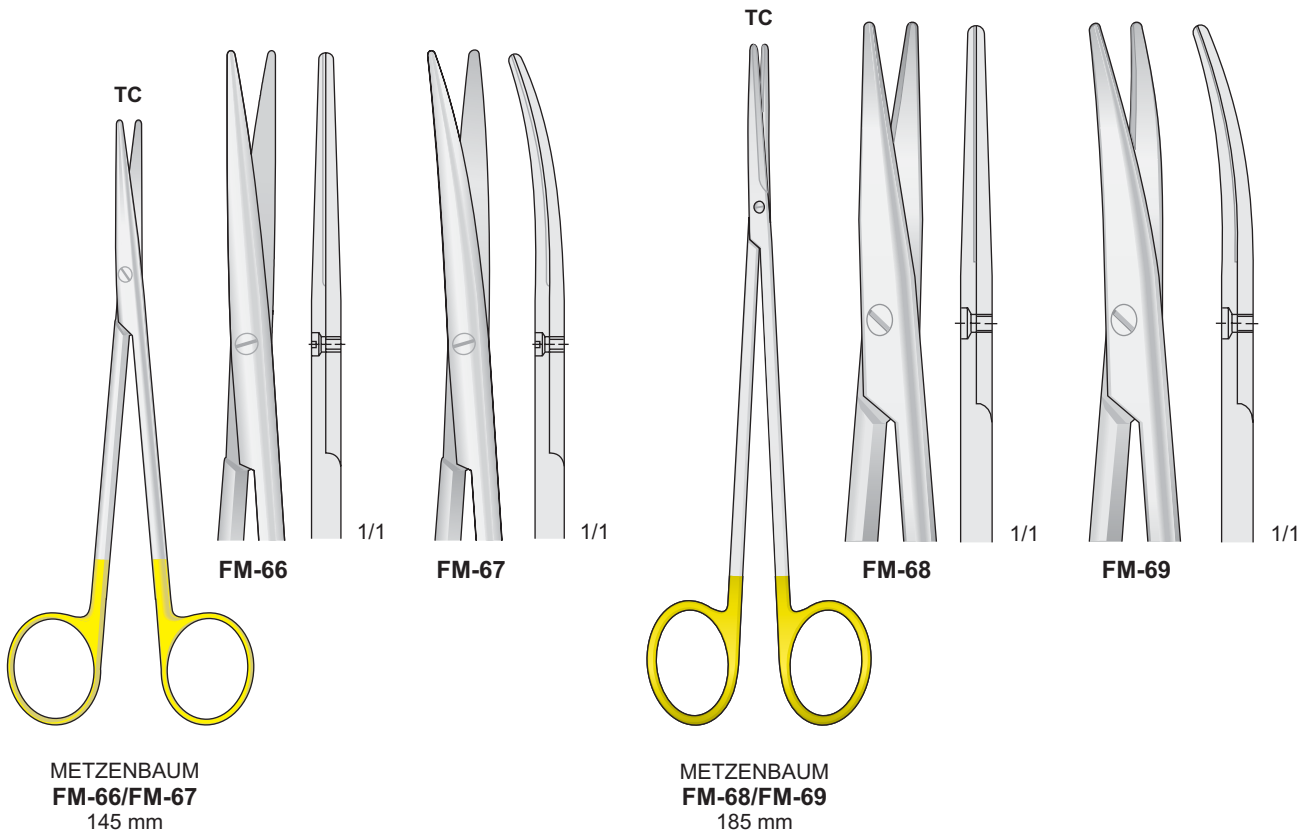

Mit Hartmetalleinsätzen - Tungsten-carbide scissors
Con punta al carburo di tungsteno - Tijeras de tungsteno - Avec plaquettes en carbure de tungstène

TC

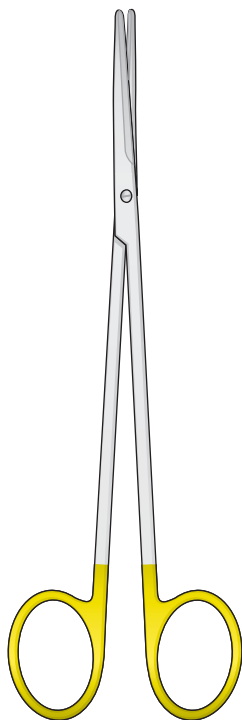

METZENBAUM-FINO
FM-201/FM-205

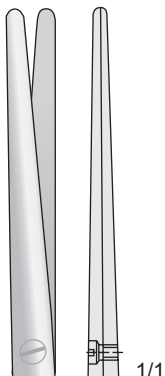

FM-201
140 mm

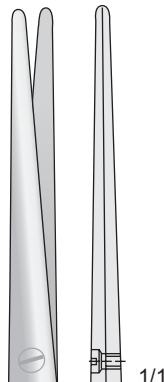

FM-203
180 mm

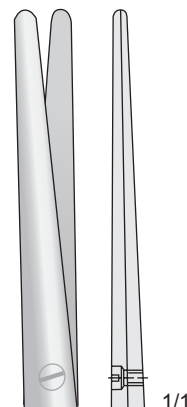

FM-205
200 mm

TC

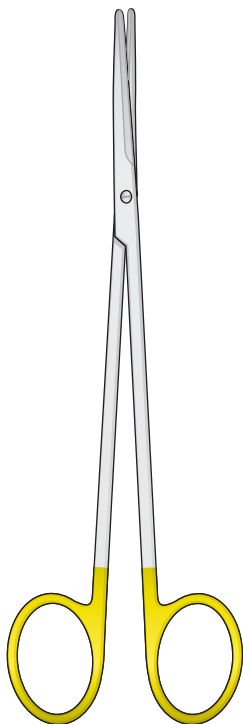

METZENBAUM-FINO
FM-207/FM-211

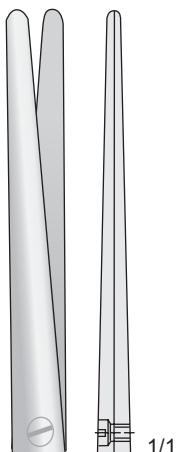

FM-207
230 mm

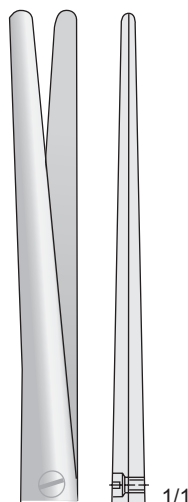

FM-209
250 mm

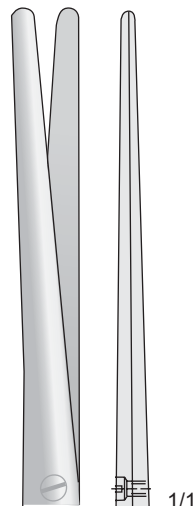

FM-211
280 mm

Mit Hartmetalleinsätzen - Tungsten-carbide scissors
Con punta al carburo di tungsteno - Tijeras de tungsteno - Avec plaquettes en carbure de tungstène

TC

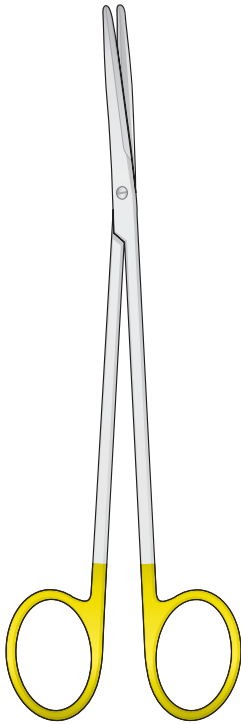

METZENBAUM-FINO
FM-202/FM-206

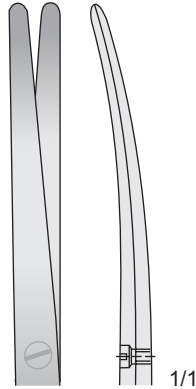

FM-202
140 mm

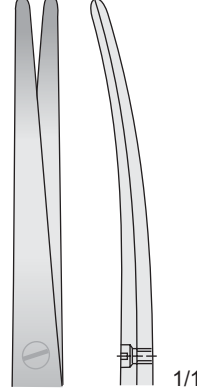

FM-204
180 mm

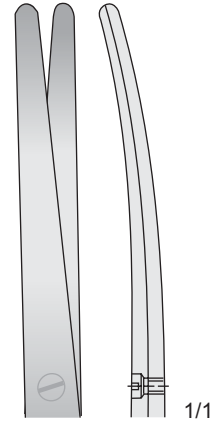

FM-206
200 mm

TC

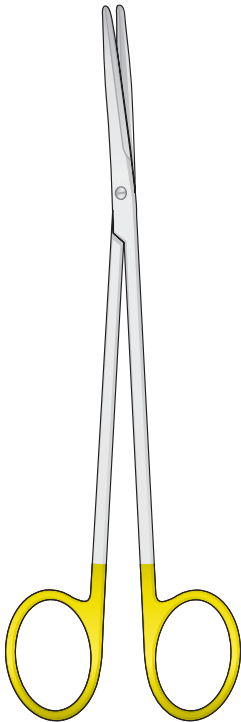

METZENBAUM-FINO
FM-208/FM-212

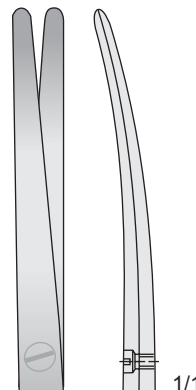

FM-208
230 mm

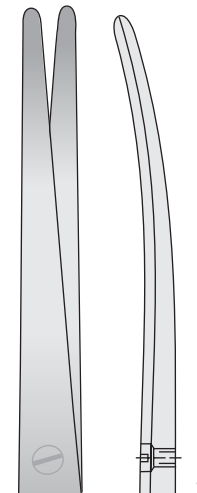

FM-210
250 mm

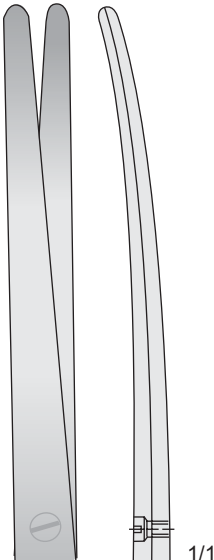

FM-212
280 mm

Mit Hartmetalleinsätzen - Tungsten-carbide scissors
Con punta al carburo di tungsteno - Tijeras de tungsteno - Avec plaquettes en carbure de tungstène

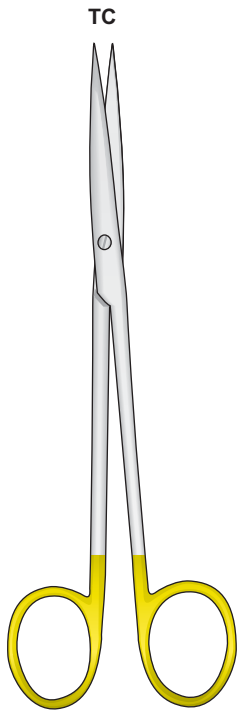

METZENBAUM-FINO
FM-96/FM-99

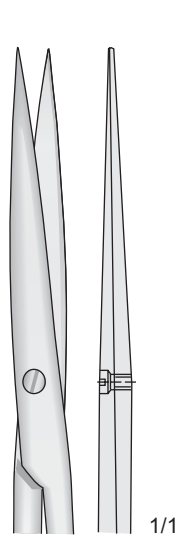

FM-96
140 mm

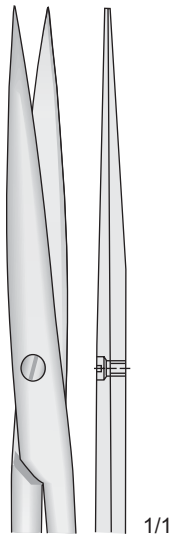

FM-97
180 mm

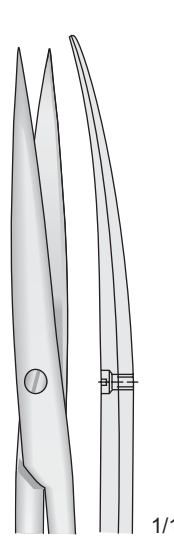

FM-98
140 mm

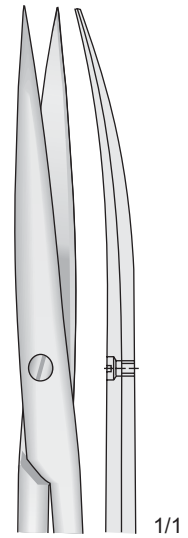

FM-99
180 mm

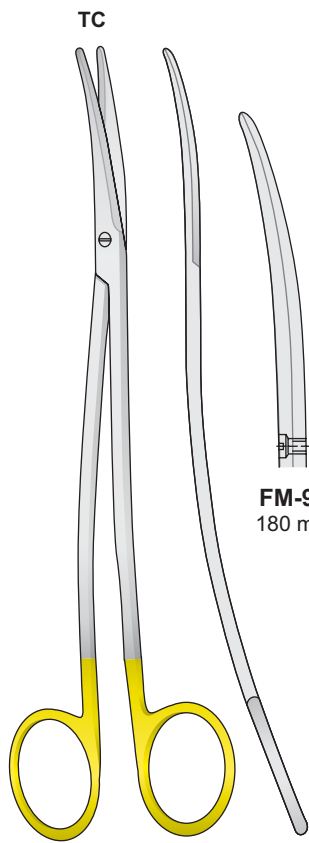

METZENBAUM-FINO
FM-90/FM-94

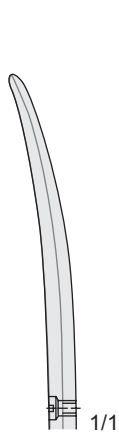

FM-90
180 mm

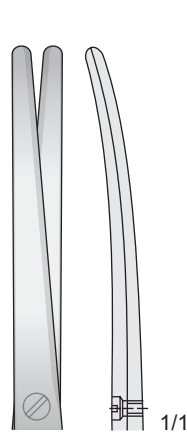

FM-92
200 mm

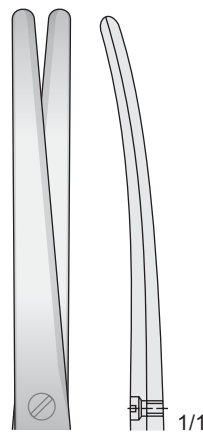

FM-94
230 mm

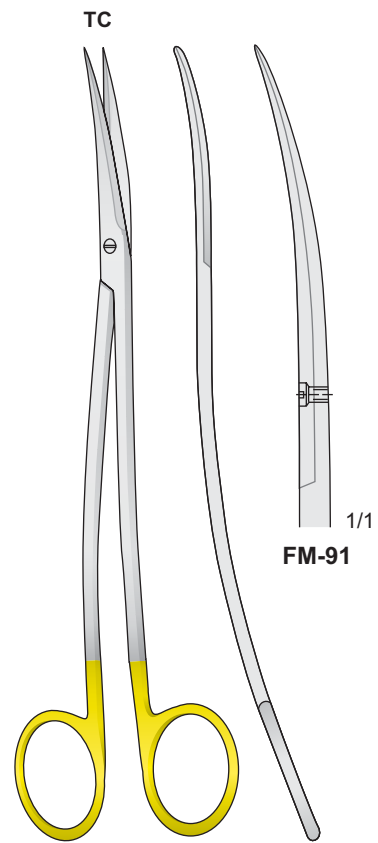

METZENBAUM-FINO
FM-91
180 mm

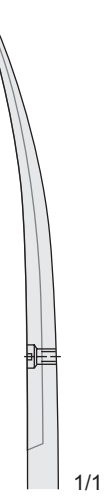

FM-91

Mit Hartmetalleinsätzen - Tungsten-carbide scissors
Con punta al carburo di tungsteno - Tijeras de tungsteno - Avec plaquettes en carbure de tungstène

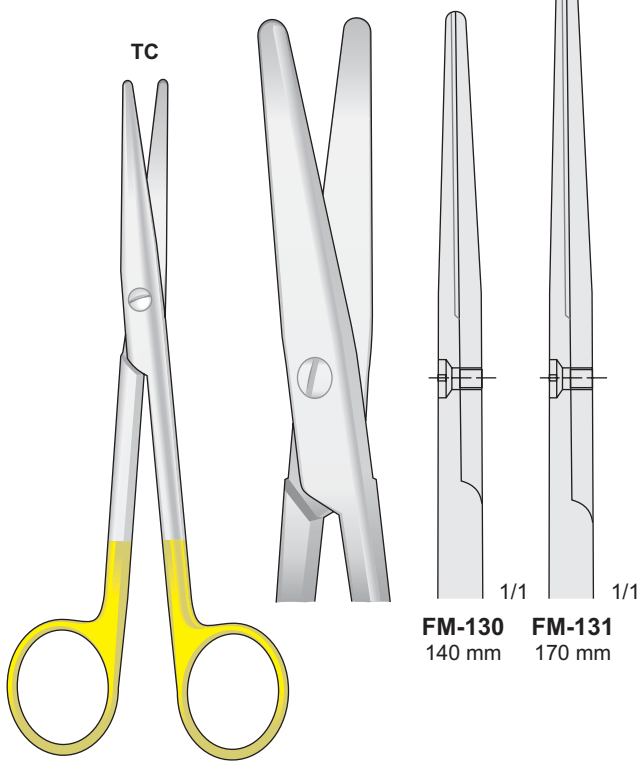

MAYO-STILLE
FM-130/FM-131

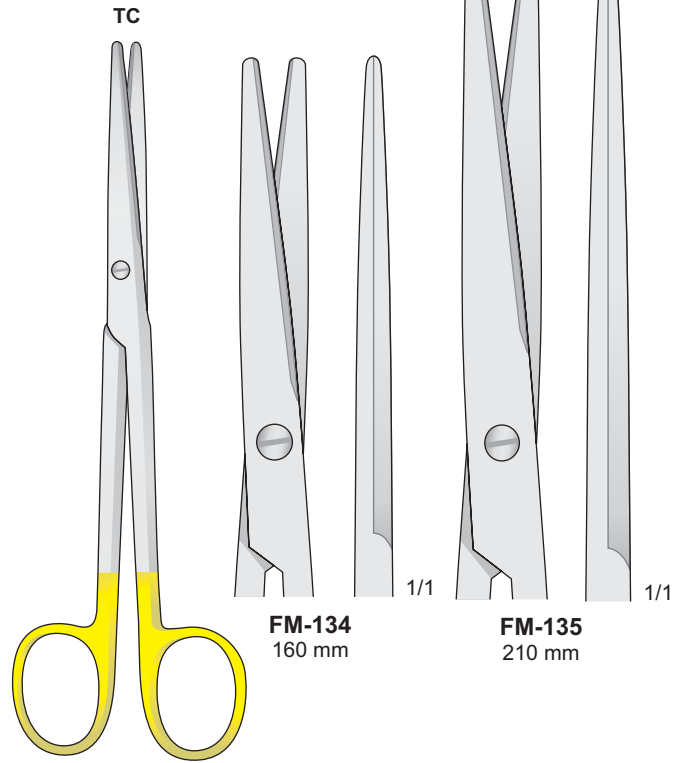

LEXER
FM-134/FM-135

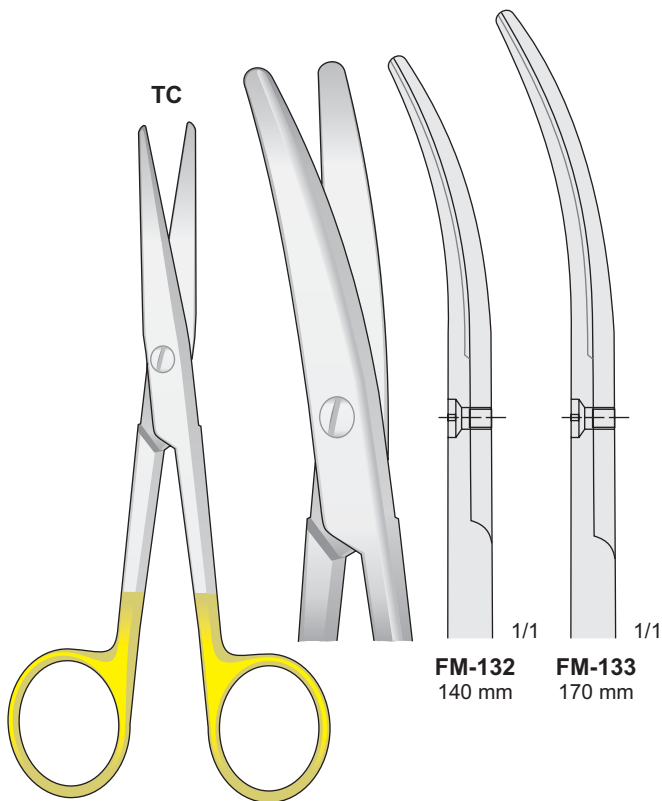

MAYO-STILLE
FM-132/FM-133

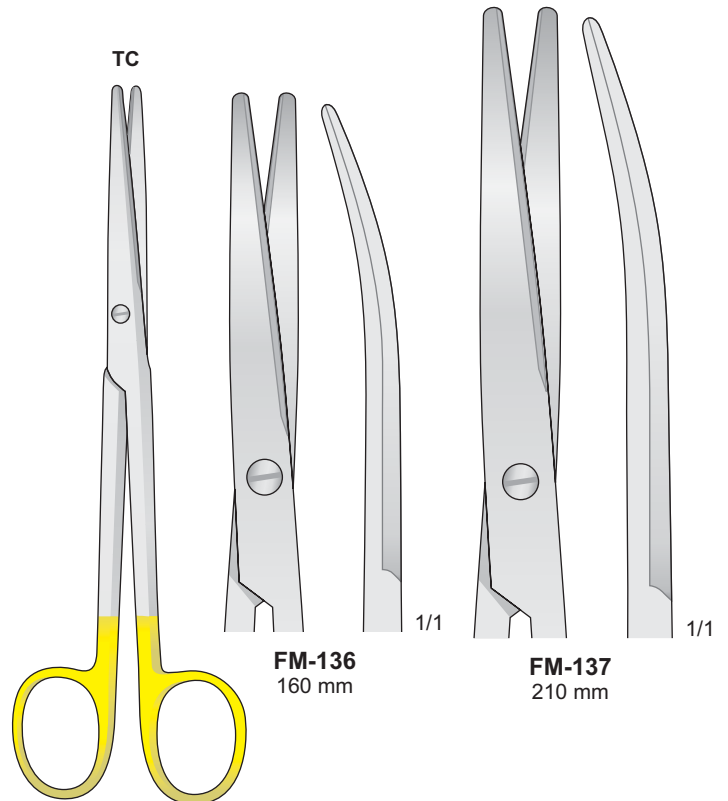

LEXER
FM-136/FM-137

Mit Hartmetalleinsätzen - Tungsten-carbide scissors
Con punta al carburo di tungsteno - Tijeras de tungsteno - Avec plaquettes en carbure de tungstène

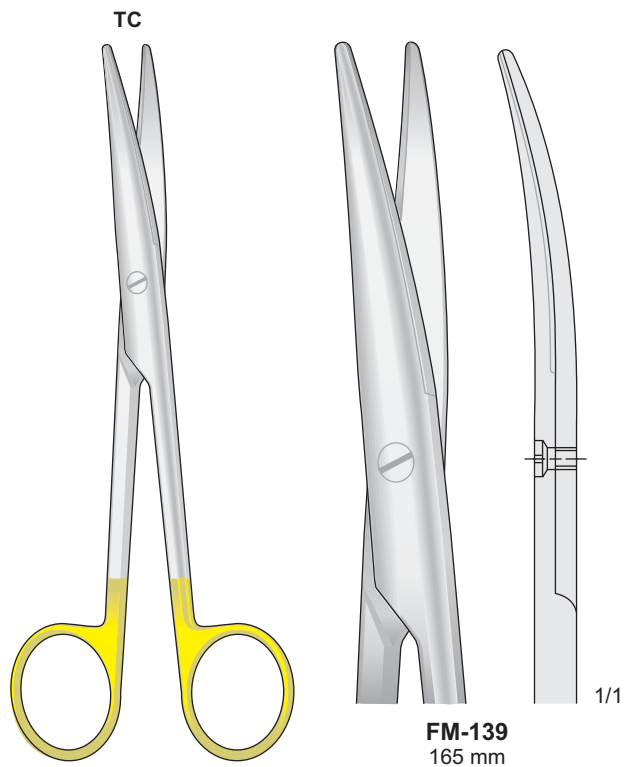

MAYO-LEXER
FM-139
165 mm

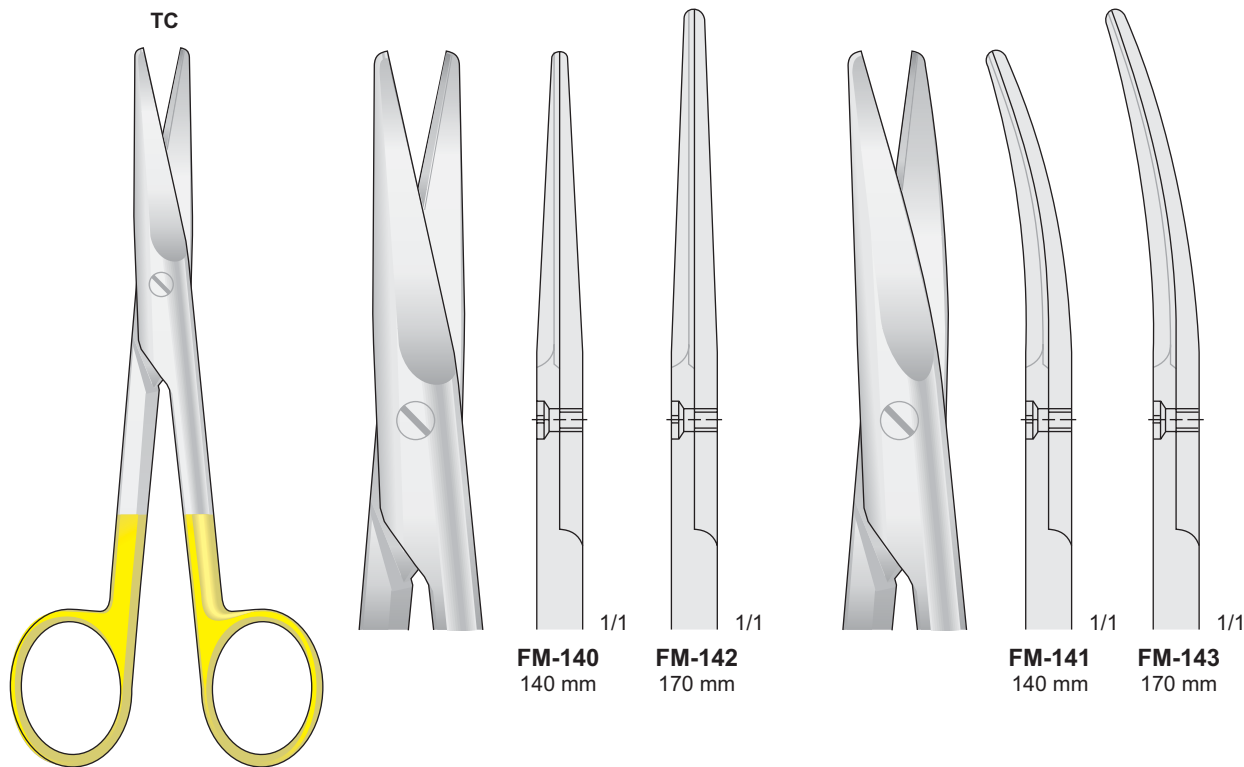

MAYO
FM-140/FM-143

Mit Hartmetalleinsätzen - Tungsten-carbide scissors
Con punta al carburo di tungsteno - Tijeras de tungsteno - Avec plaquettes en carbure de tungstène

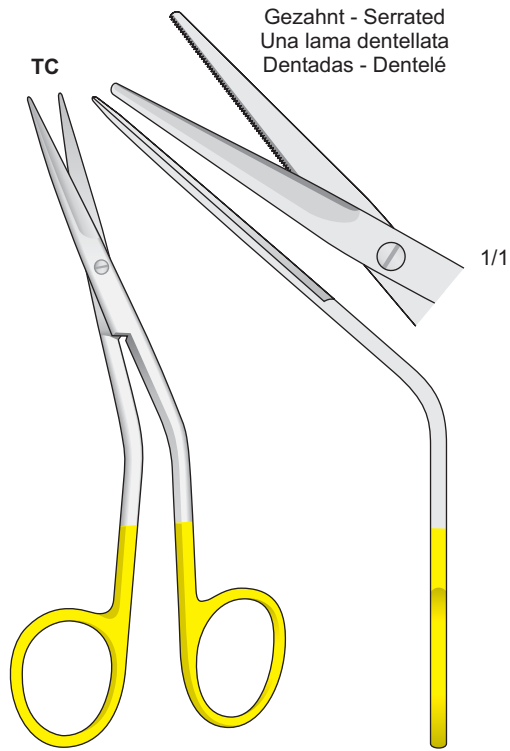

FOMON
FG-165
135 mm

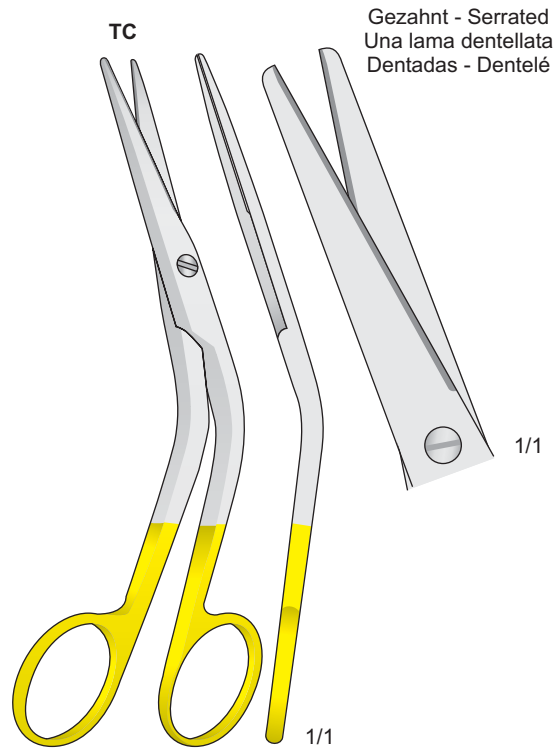

COTTLE
FG-166
160 mm

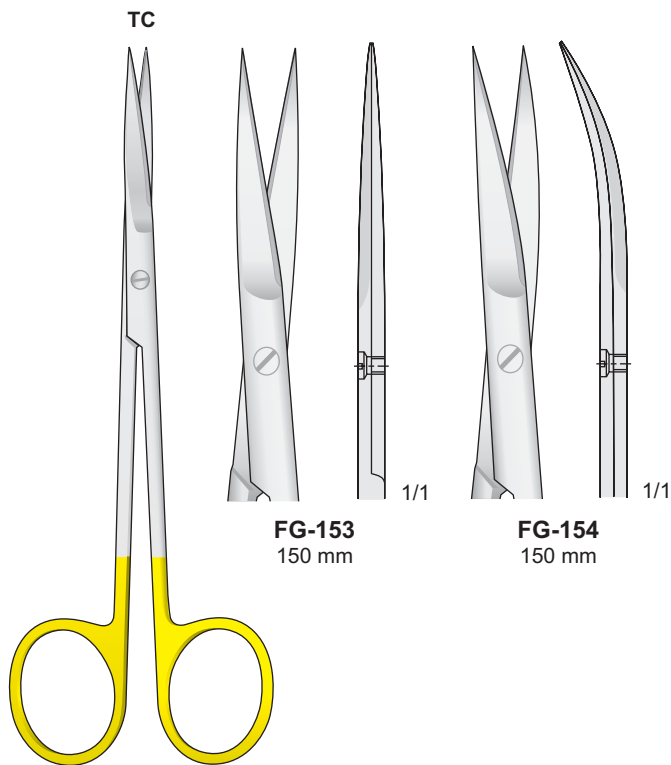

JOSEPH
FG-153/FG-154
150 mm

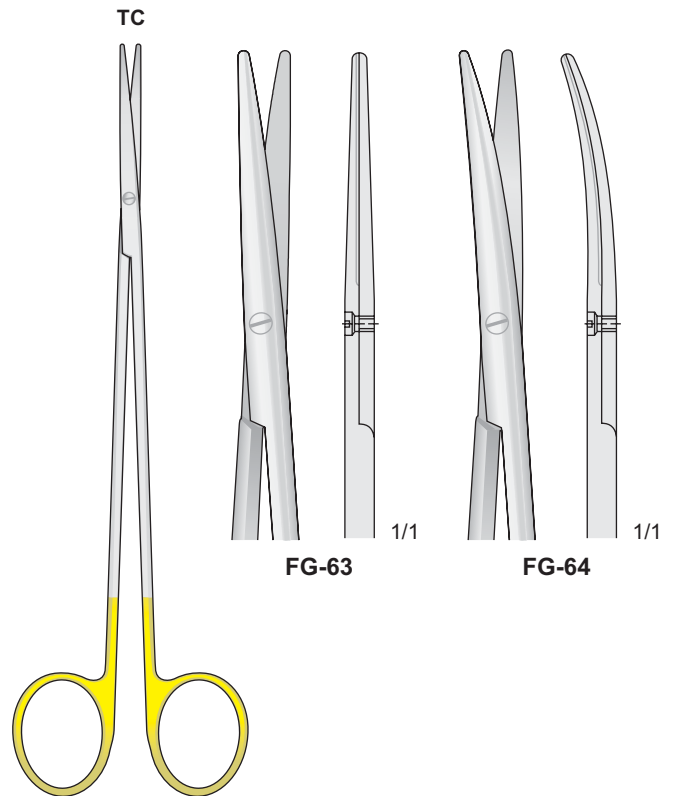

TOENNIS-ADSON
FG-63/FG-64
180 mm

Mit Hartmetalleinsätzen - Tungsten-carbide scissors
Con punta al carburo di tungsteno - Tijeras de tungsteno - Avec plaquettes en carbure de tungstène

Scheren mit Wellenschliff auf einer Schnittfläche
Scissors cut one serrated cutting edge
Forbici con taglio ondulato su una lama
Tijeras con ondas afilados
Ciseaux avec affutage spécial ont une lame dentée

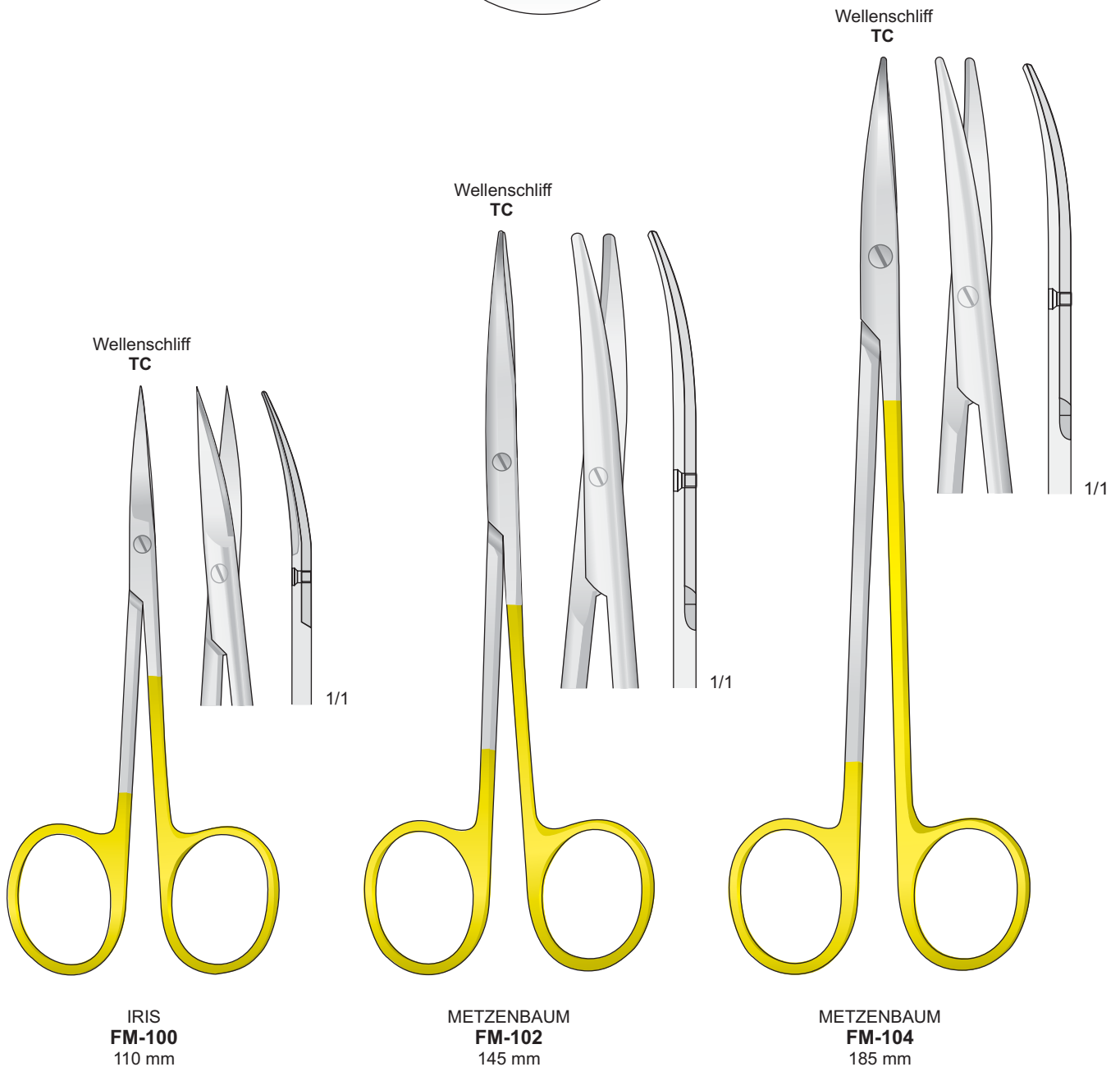
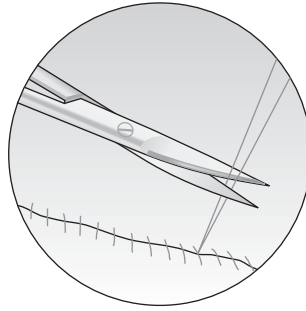

Mit Hartmetalleinsätzen - Tungsten-carbide scissors
Con punta al carburo di tungsteno - Tijeras de tungsteno - Avec plaquettes en carbure de tungstène

Mit einer Schneide gezahnt
With one blade serrated
Con una lama zigrinata
Con una hoja dentada
Avec lame dentèle

TC

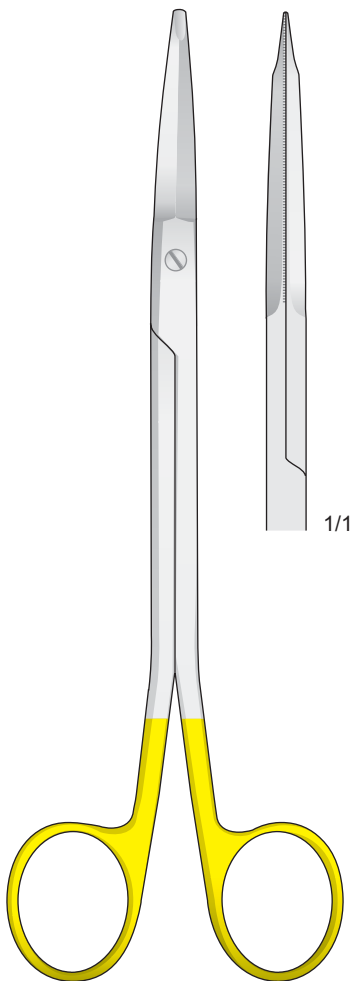

FREEMAN-GORNEY
FM-311
180 mm

Mit einer Schneide gezahnt
With one blade serrated
Con una lama zigrinata
Con una hoja dentada
Avec lame dentèle

TC

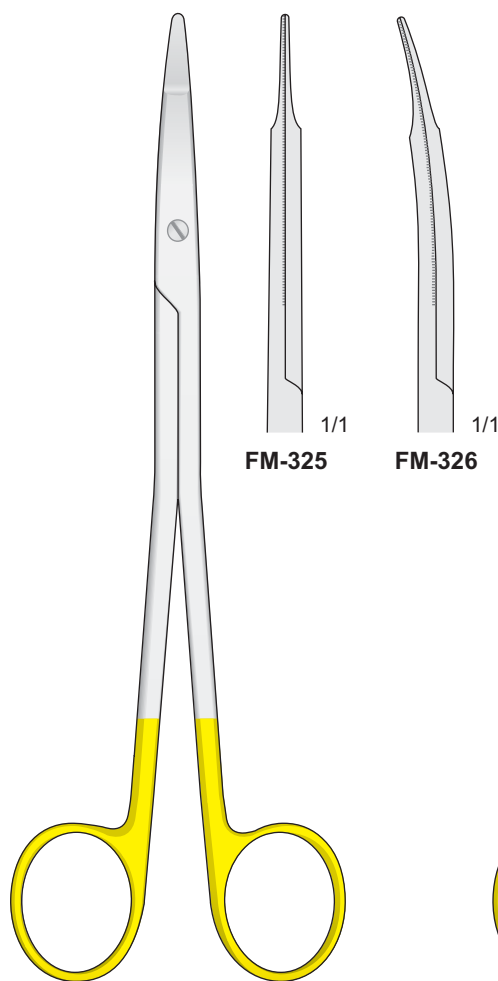

FREEMAN
FM-325/FM-326
180 mm

Mit einer Schneide gezahnt
With one blade serrated
Con una lama zigrinata
Con una hoja dentada
Avec lame dentèle

TC

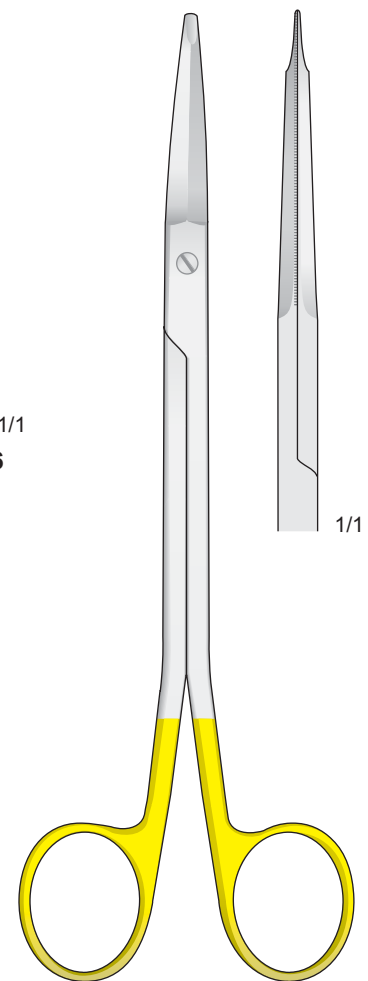

FREEMAN-KAYE
FM-334
180 mm

Mit Hartmetalleinsätzen - Tungsten-carbide scissors
Con punta al carburo di tungsteno - Tijeras de tungsteno - Avec plaquettes en carbure de tungstène

Mit einer Schneide gezahnt
With one blade serrated
Con una lama zigrinata
Con una hoja dentada
Avec lame dentèle

Mit einer Schneide gezahnt
With one blade serrated
Con una lama zigrinata
Con una hoja dentada
Avec lame dentèle

Mit einer Schneide gezahnt
With one blade serrated
Con una lama zigrinata
Con una hoja dentada
Avec lame dentèle

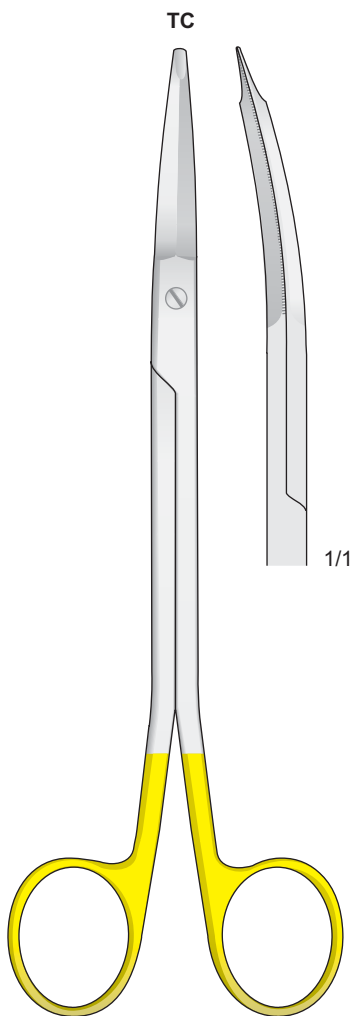

FREEMAN-KAYE
FM-335
180 mm

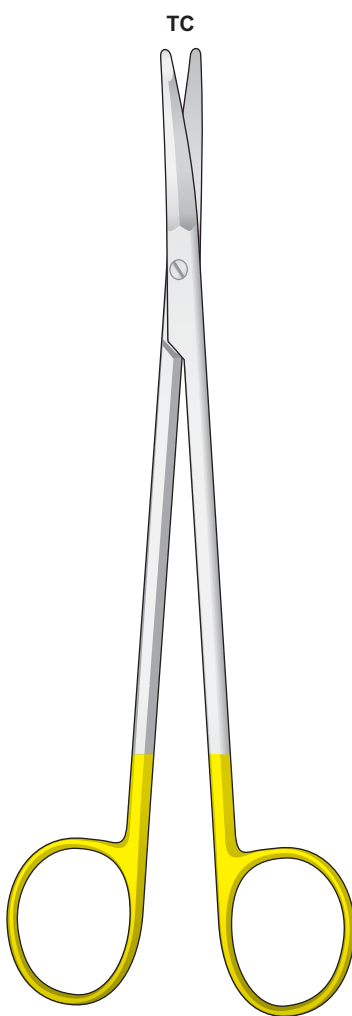

FACE LIFT
FM-338
180 mm

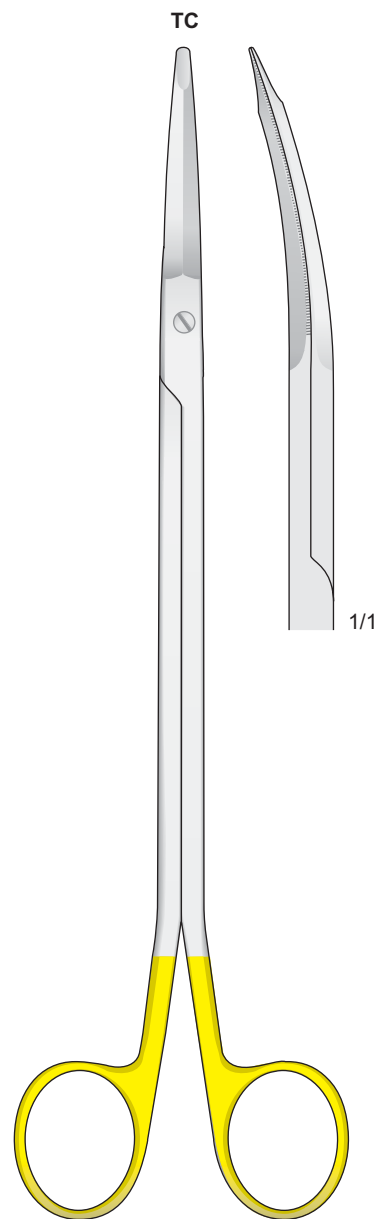

GORNEY
FM-312
230 mm

Mit Hartmetalleinsätzen - Tungsten-carbide scissors
Con punta al carburo di tungsteno - Tijeras de tungsteno - Avec plaquettes en carbure de tungstène

S-Förmig Gebogen
S-Shaped
Forma S
Informa a S
Forme S

Mit einer Schneide gezahnt
With one blade serrated
Con una lama zigrinata
Con una hoja dentada
Avec lame dentèle

Mit einer Schneide gezahnt
With one blade serrated
Con una lama zigrinata
Con una hoja dentada
Avec lame dentèle

Mit einer Schneide gezahnt
With one blade serrated
Con una lama zigrinata
Con una hoja dentada
Avec lame dentèle

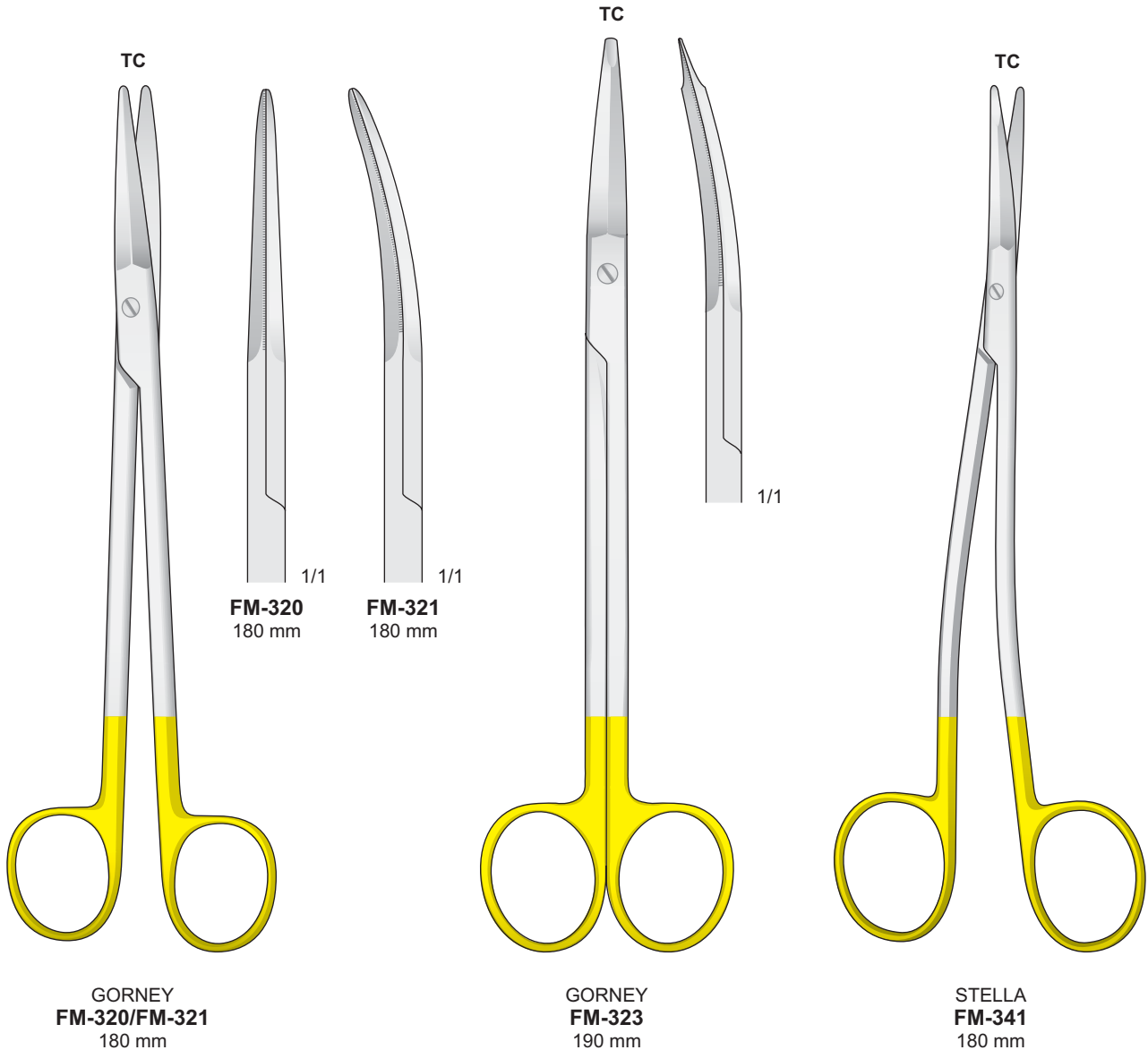

Mit Hartmetalleinsätzen - Tungsten-carbide scissors
Con punta al carburo di tungsteno - Tijeras de tungsteno - Avec plaquettes en carbure de tungstène

Mit einer Schneide gezahnt
With one blade serrated
Con una lama zigrinata
Con una hoja dentada
Avec lame dentée

TC

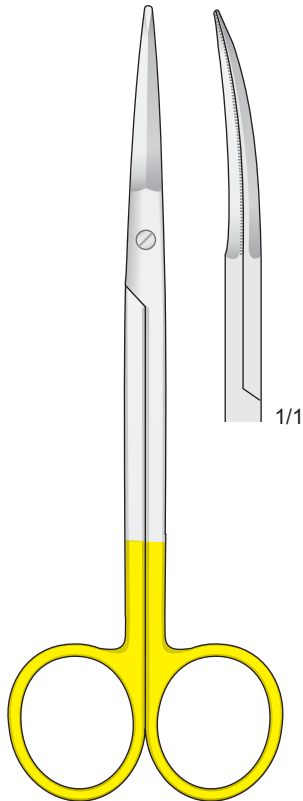

GREGORY
FM-339
140 mm

Mit einer Schneide gezahnt
With one blade serrated
Con una lama zigrinata
Con una hoja dentada
Avec lame dentée

TC

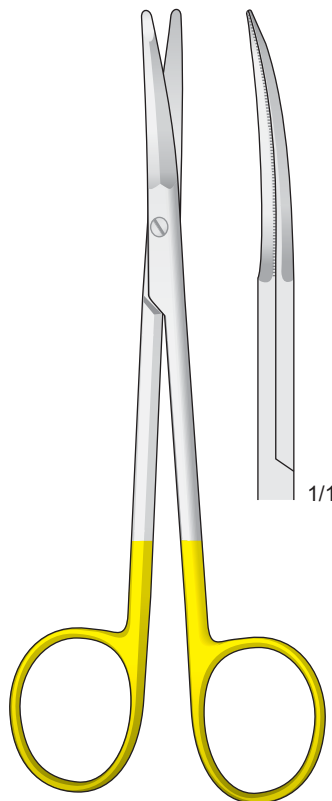

FACE LIFT
FM-340
150 mm

Mit einer Schneide gezahnt
With one blade serrated
Con una lama zigrinata
Con una hoja dentada
Avec lame dentée

TC

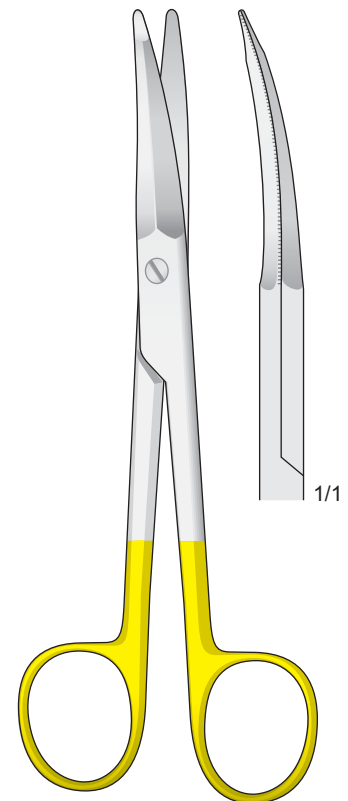

FACE LIFT
FM-342
140 mm

Mit Hartmetalleinsätzen - Tungsten-carbide scissors
Con punta al carburo di tungsteno - Tijeras de tungsteno - Avec plaquettes en carbure de tungstène

Mit einer Schneide gezahnt
With one blade serrated
Con una lama zigrinata
Con una hoja dentada
Avec lame dentèle

Mit einer Schneide gezahnt
With one blade serrated
Con una lama zigrinata
Con una hoja dentada
Avec lame dentèle

TC

TC

Mit einer Schneide gezahnt
With one blade serrated
Con una lama zigrinata
Con una hoja dentada
Avec lame dentèle

TC

Super Cut

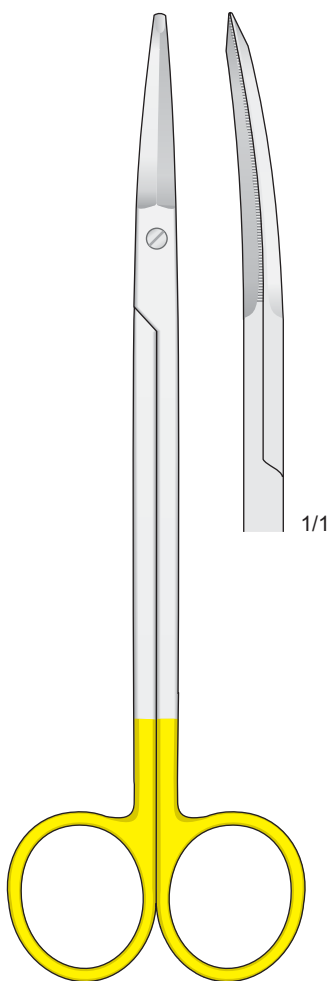

1/1

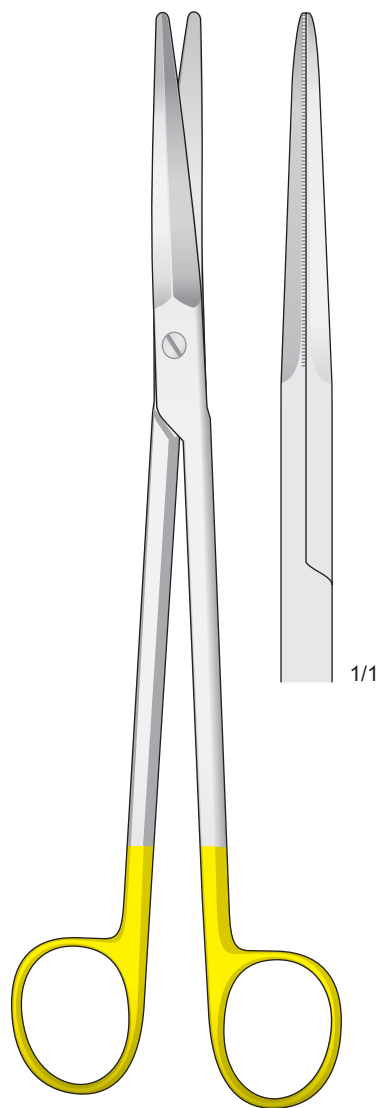

1/1

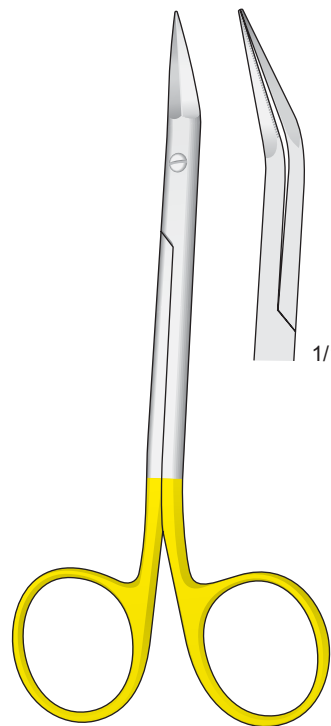

1/1

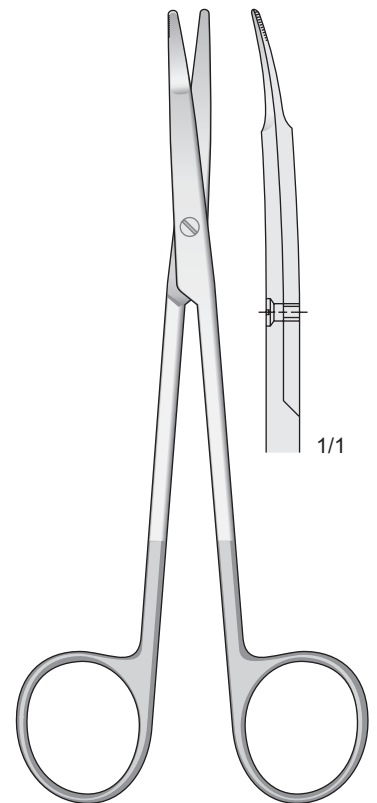

1/1

FACE-LIFT
FM-343
180 mm

GORNEY
FM-344
200 mm

GIUNTA-NASAL
FM-351
130 mm

KILNER
FM-305
150 mm

Mit Hartmetalleinsätzen - Tungsten-carbide scissors
Con punta al carburo di tungsteno - Tijeras de tungsteno - Avec plaquettes en carbure de tungstène

Mit einer Schneide gezahnt
With one blade serrated
Con una lama zigrinata
Con una hoja dentada
Avec lame dentèle

Super Cut
TC

Mit einer Schneide gezahnt
With one blade serrated
Con una lama zigrinata
Con una hoja dentada
Avec lame dentèle

Super Cut
TC

Mit einer Schneide gezahnt
With one blade serrated
Con una lama zigrinata
Con una hoja dentada
Avec lame dentèle

Super Cut
TC

Mit einer Schneide gezahnt
With one blade serrated
Con una lama zigrinata
Con una hoja dentada
Avec lame dentèle

Super Cut
TC

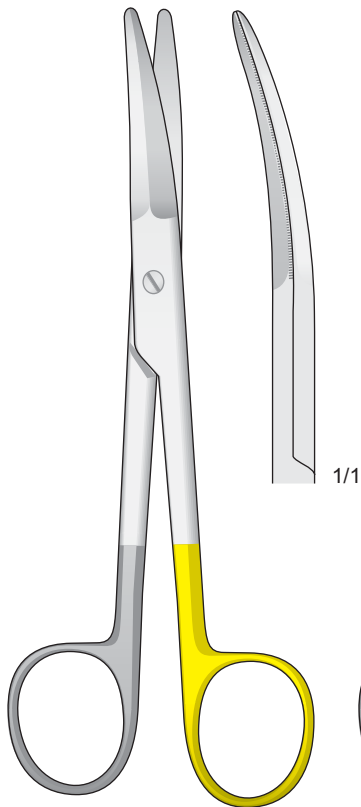

KAYE FACE-LIFT
FM-306
150 mm

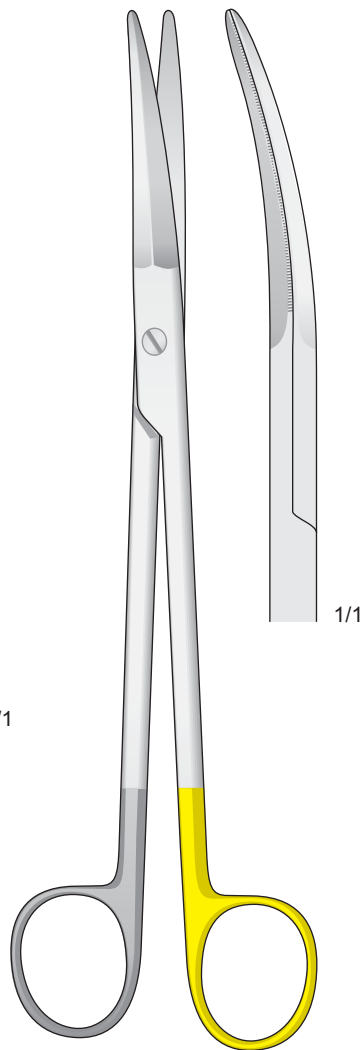

KAYE FACE-LIFT
FM-307
190 mm

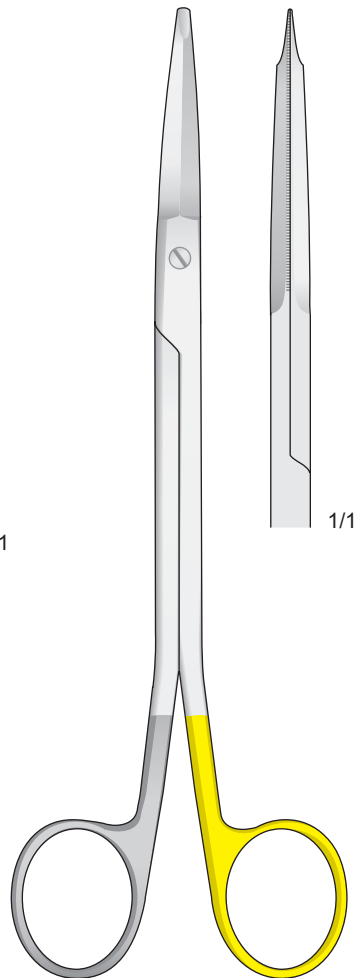

FREEMAN GORNEY
FM-310
180 mm

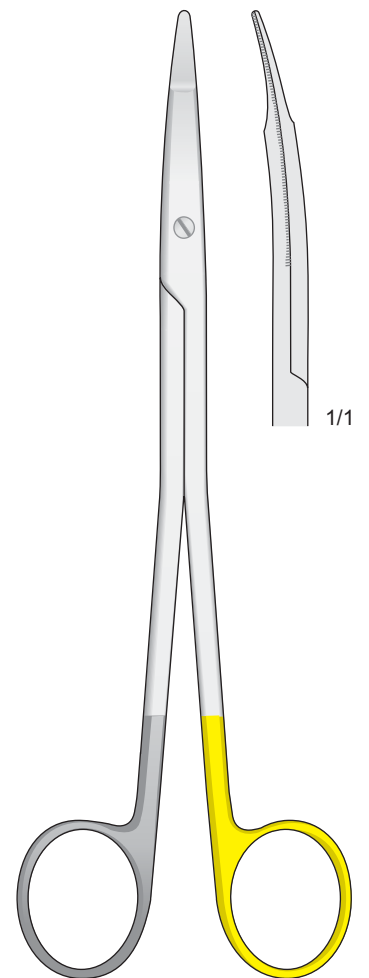

FREEMAN
FM-330
180 mm

Mit Hartmetalleinsätzen
Tungsten-carbide scissors
Con punta al carburo di tungsteno
Tijeras de tungsteno
Avec plaquettes en carbure de tungstène

Mit einer Schneide gezahnt
With one blade serrated
Con una lama zigrinata
Con una hoja dentada
Avec lame dentèle

Super Cut
TC

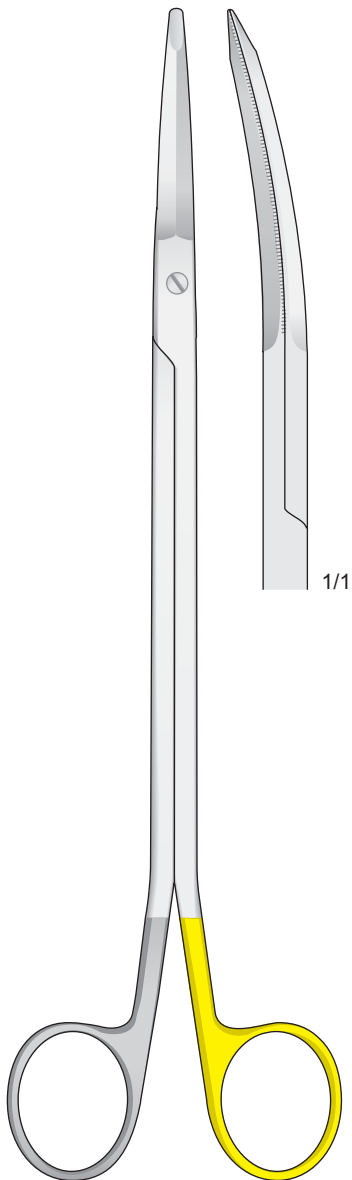

GORNEY
FM-331
230 mm

Mit einer Schneide gezahnt
With one blade serrated
Con una lama zigrinata
Con una hoja dentada
Avec lame dentèle

Super Cut

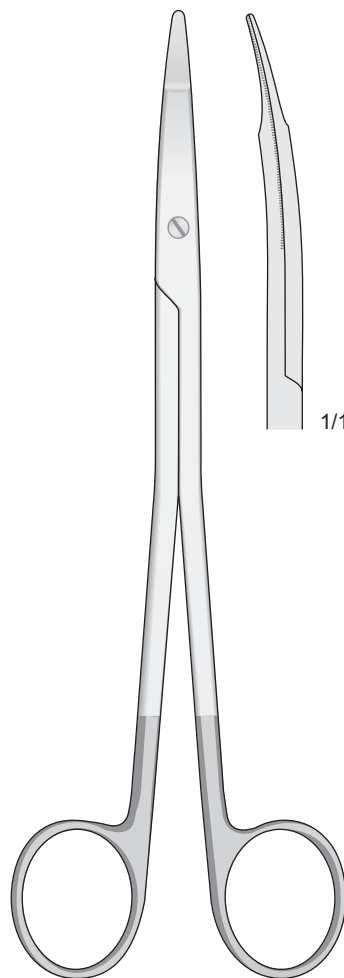

FREEMAN
FM-328
180 mm

Mit Hartmetalleinsätzen
Tungsten-carbide scissors
Con punta al carburo di tungsteno
Tijeras de tungsteno
Avec plaquettes en carbure de tungstène

Mit einer Schneide gezahnt
With one blade serrated
Con una lama zigrinata
Con una hoja dentada
Avec lame dentèle

Super Cut
TC

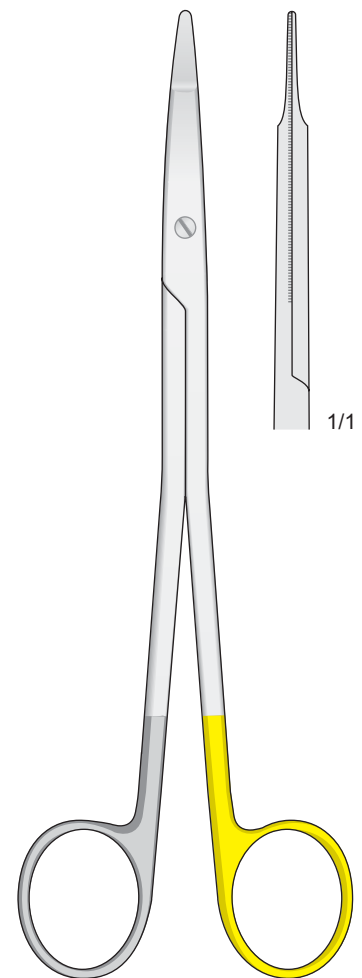

FREEMAN
FM-329
180 mm

Mit Hartmetalleinsätzen - Tungsten-carbide scissors
Con punta al carburo di tungsteno - Tijeras de tungsteno - Avec plaquettes en carbure de tungstène

Mit einer Schneide gezahnt
With one blade serrated
Con una lama zigrinata
Con una hoja dentada
Avec lame dentèle

Super Cut
TC

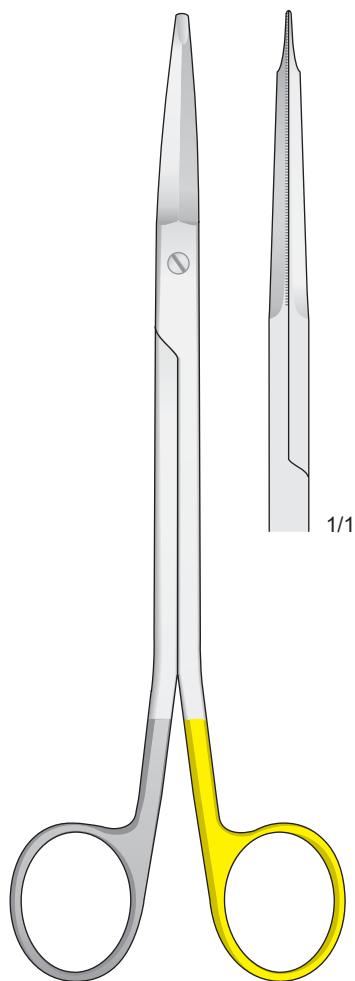

FREEMAN KAYE
FM-336
180 mm

Mit einer Schneide gezahnt
With one blade serrated
Con una lama zigrinata
Con una hoja dentada
Avec lame dentèle

Super Cut
TC

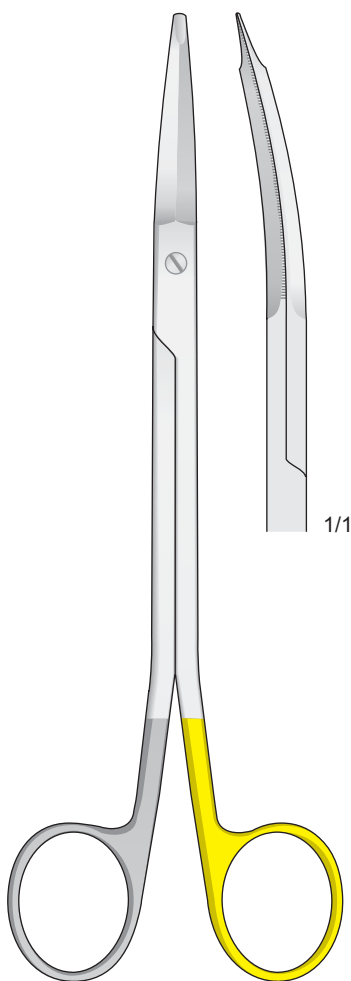

FREEMAN KAYE
FM-337
180 mm

Mit einer Schneide gezahnt
With one blade serrated
Con una lama zigrinata
Con una hoja dentada
Avec lame dentèle

Super Cut
TC

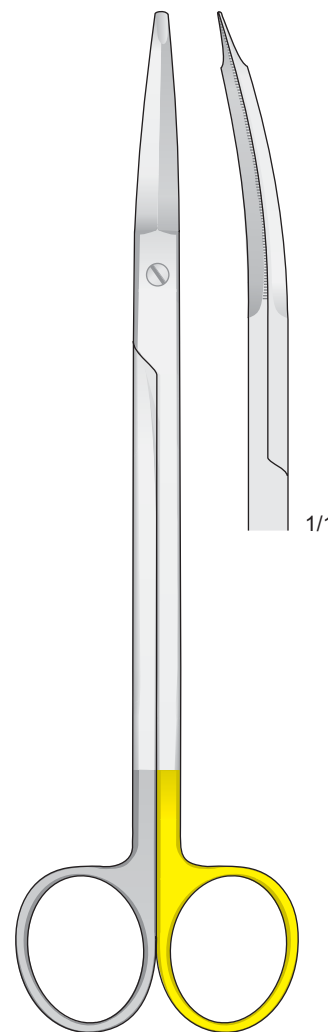

GORNEY
FM-324
190 mm

Ligaturscheren

Ligature scissors

Forbici per suture

Tijeras para ligaduras

Ciseaux à ligatures

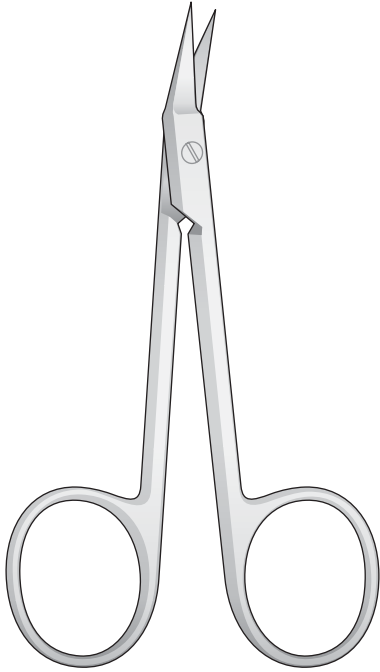

**O'BRIEN
FG-151**
95 mm

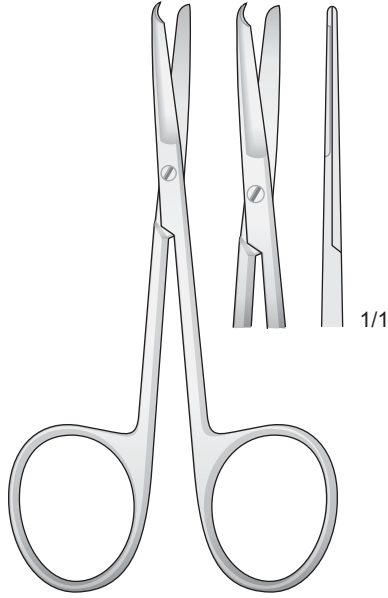

**SPENCER
SC-9**
90 mm

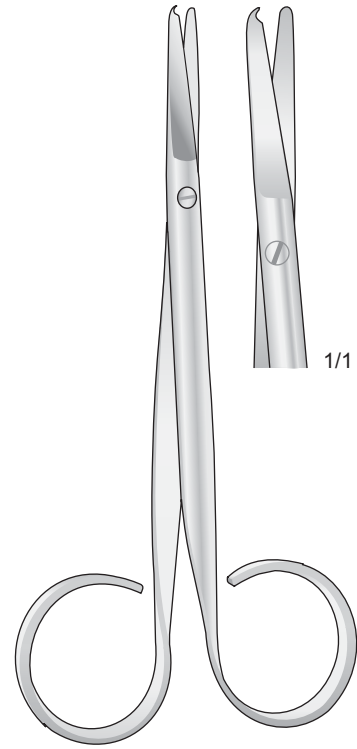

**SPENCER
SC-1**
110 mm

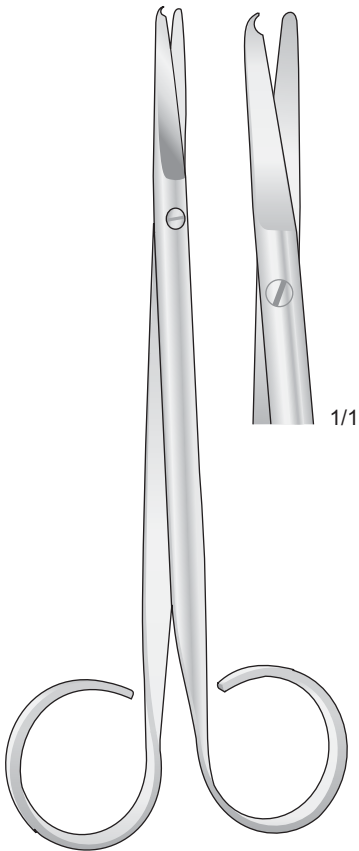

**SPENCER
SC-2**
145 mm

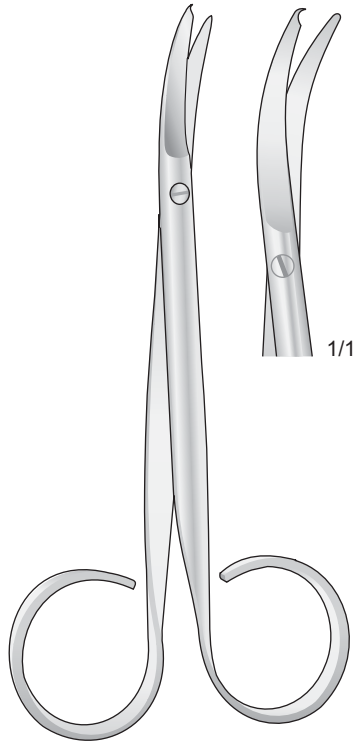

**SPENCER
SC-5**
110 mm

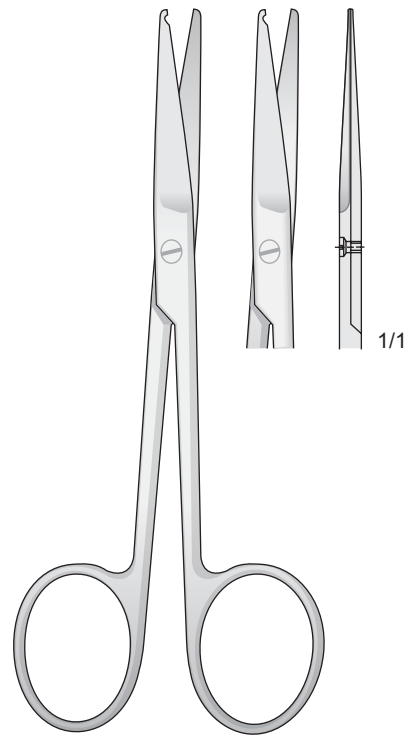

SC-12
115 mm

Nagelscheren

Nail Scissors

Forbici per unghie

Tijeras para hojas

Ciseaux pour les ongles

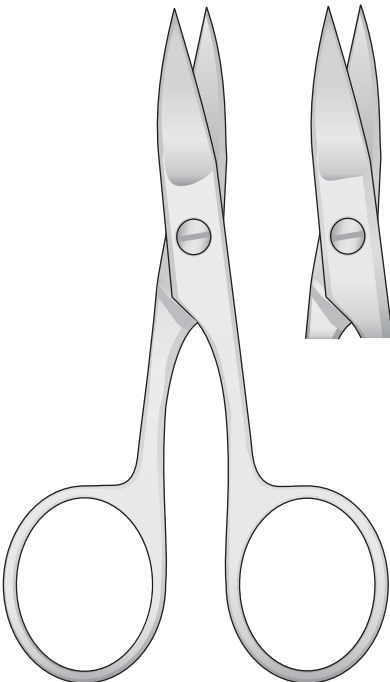

GS-23/GS-26

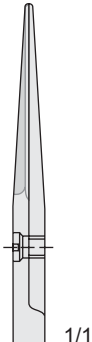

GS-23
90 mm

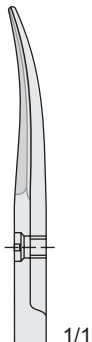

GS-24
90 mm

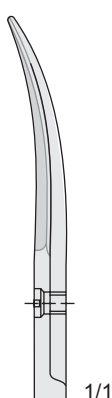

GS-25
100 mm

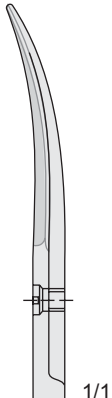

GS-26
110 mm

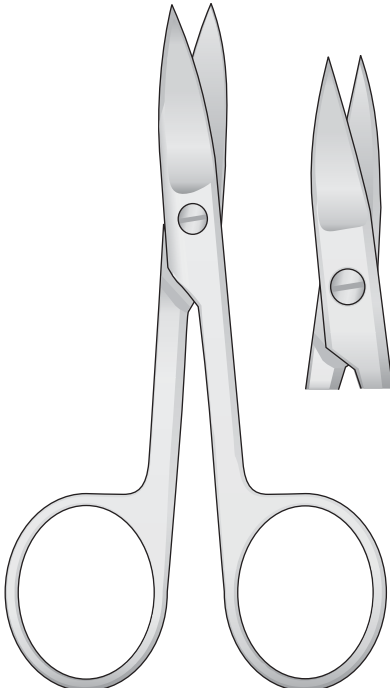

GS-27/GS-29

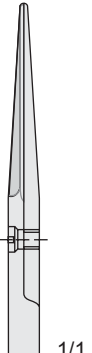

GS-27
95 mm

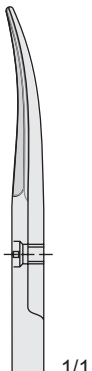

GS-28
95 mm

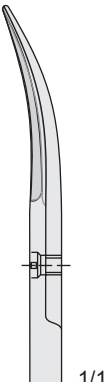

GS-29
105 mm

3

Pinzetten
Tissue Forceps
Pinzette
Pinzas
Pinces

Mikro Pinzetten

Delicate forceps

Micro pinzette

Pinzas finos

Micro pincas

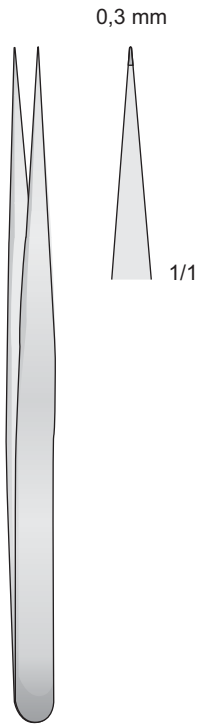

BD-235
120 mm

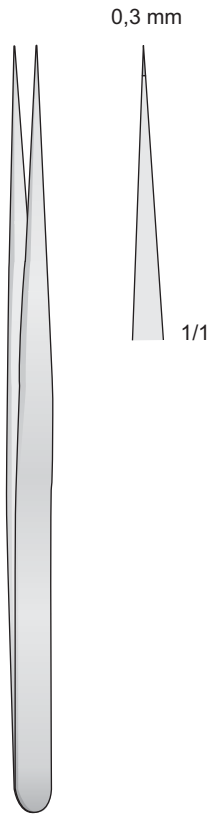

VISE
BD-236
135 mm

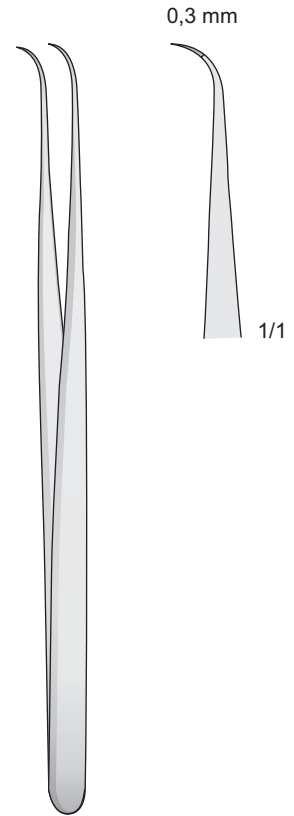

VISE
BD-237
135 mm

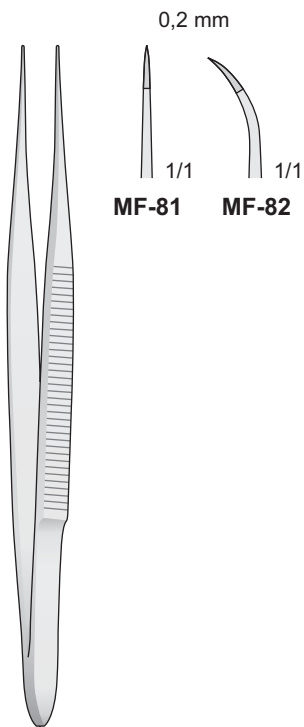

MF-81/MF-82
125 mm

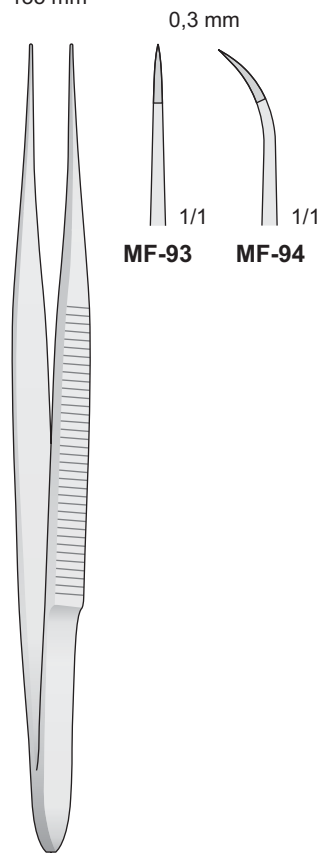

MF-93/MF-94
150 mm

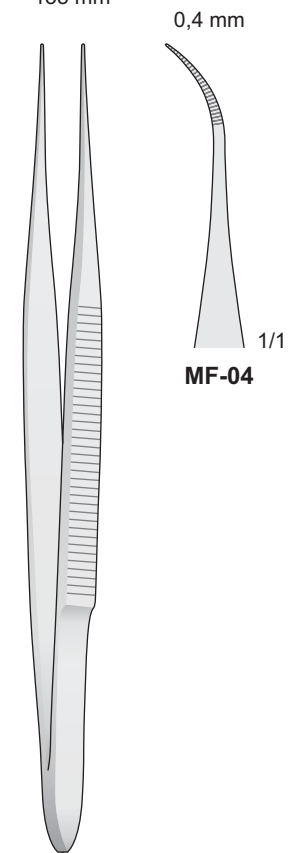

MF-04
150 mm

Mikro Pinzetten

Delicate forceps

Micro pinzette

Pinzas finos

Micro pinces

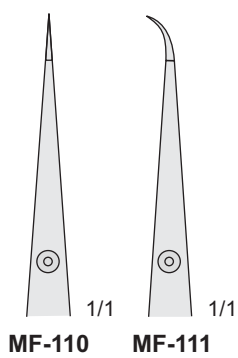
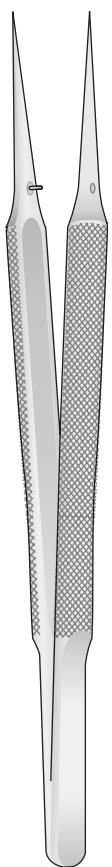

MF-110/MF-111
120 mm

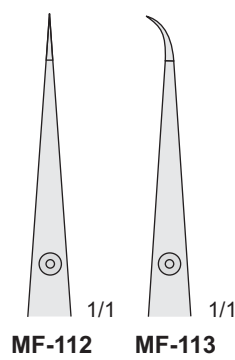
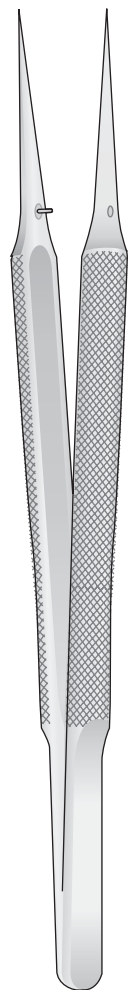

MF-112/MF-113
150 mm

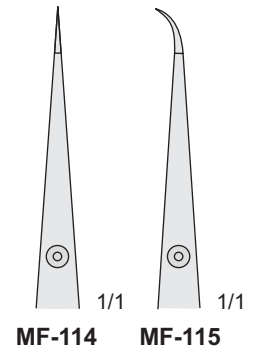
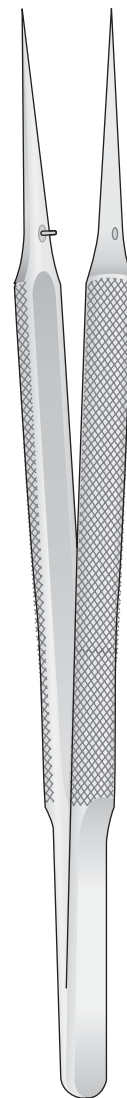

MF-114/MF-115
180 mm

Mikro Pinzetten

Delicate forceps

Micro pinzette

Pinzas finos

Micro pincers

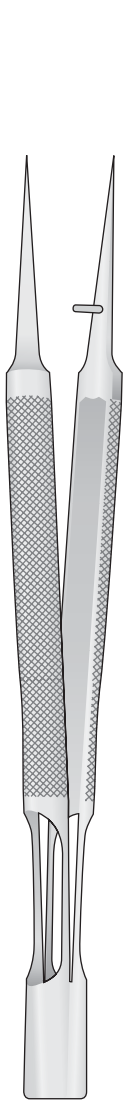
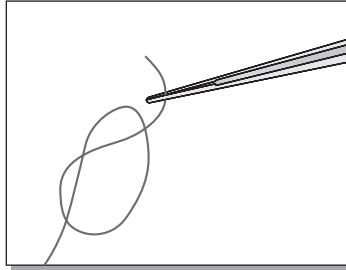

**BROCK
FD-201**
130 mm

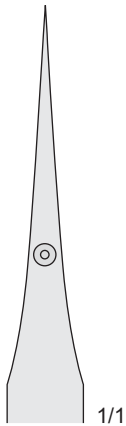

1/1

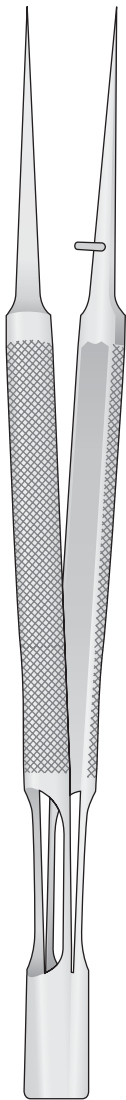

**BROCK
FD-202**
150 mm

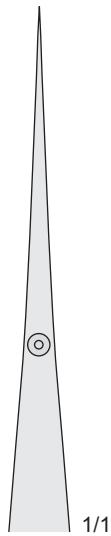

1/1

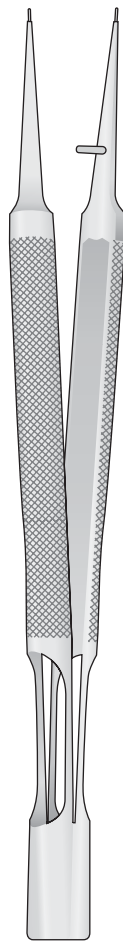

**BROCK
FD-203**
130 mm

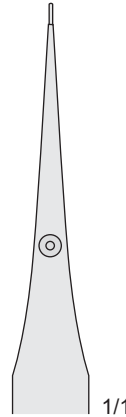

1/1

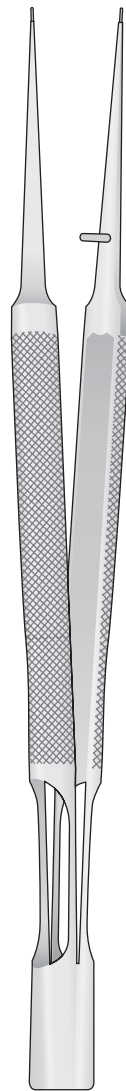

**BROCK
FD-204**
150 mm

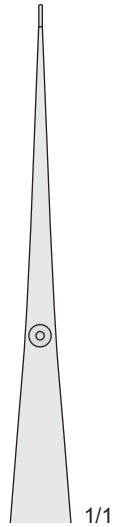

1/1

Titan - Titanium - Titanio - Titane

Mikro-Ringpinzette Ø 8 mm

Glatt - Smooth
Liscia - Lisa
Lisses

Gerieft - Serrated
Zigrinata - Estriadas
Stries

1 x 0,5 mm

1 x 0,5 mm

1/1

1/1

MF-142T
150 mm

MF-342T
150 mm

1 x 0,5 mm

1 x 0,5 mm

1/1

1/1

MF-143T
180 mm

MF-343T
180 mm

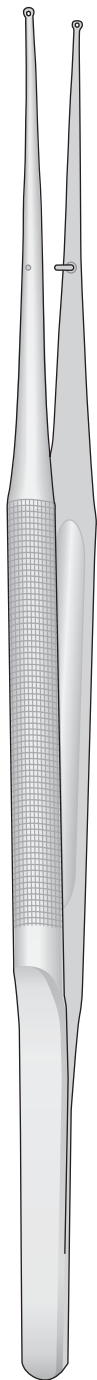

Ø 1 mm



MF-124 - 150 mm
MF-125 - 180 mm
MF-126 - 210 mm
MF-148 - 230 mm

Ø 2 mm



MF-127 - 150 mm
MF-128 - 180 mm
MF-129 - 210 mm
MF-149 - 230 mm

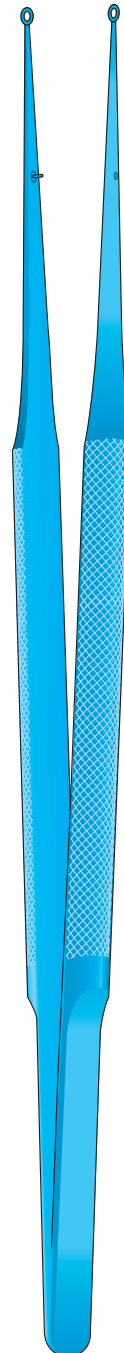

MF-124/MF-149

MF-142T/MF-343T

Titan - Titanium - Titanio - Titane

Mikro-Atrauma-Pinzette Ø 8 mm

Mikro-Knüpfpinzette Ø 8 mm

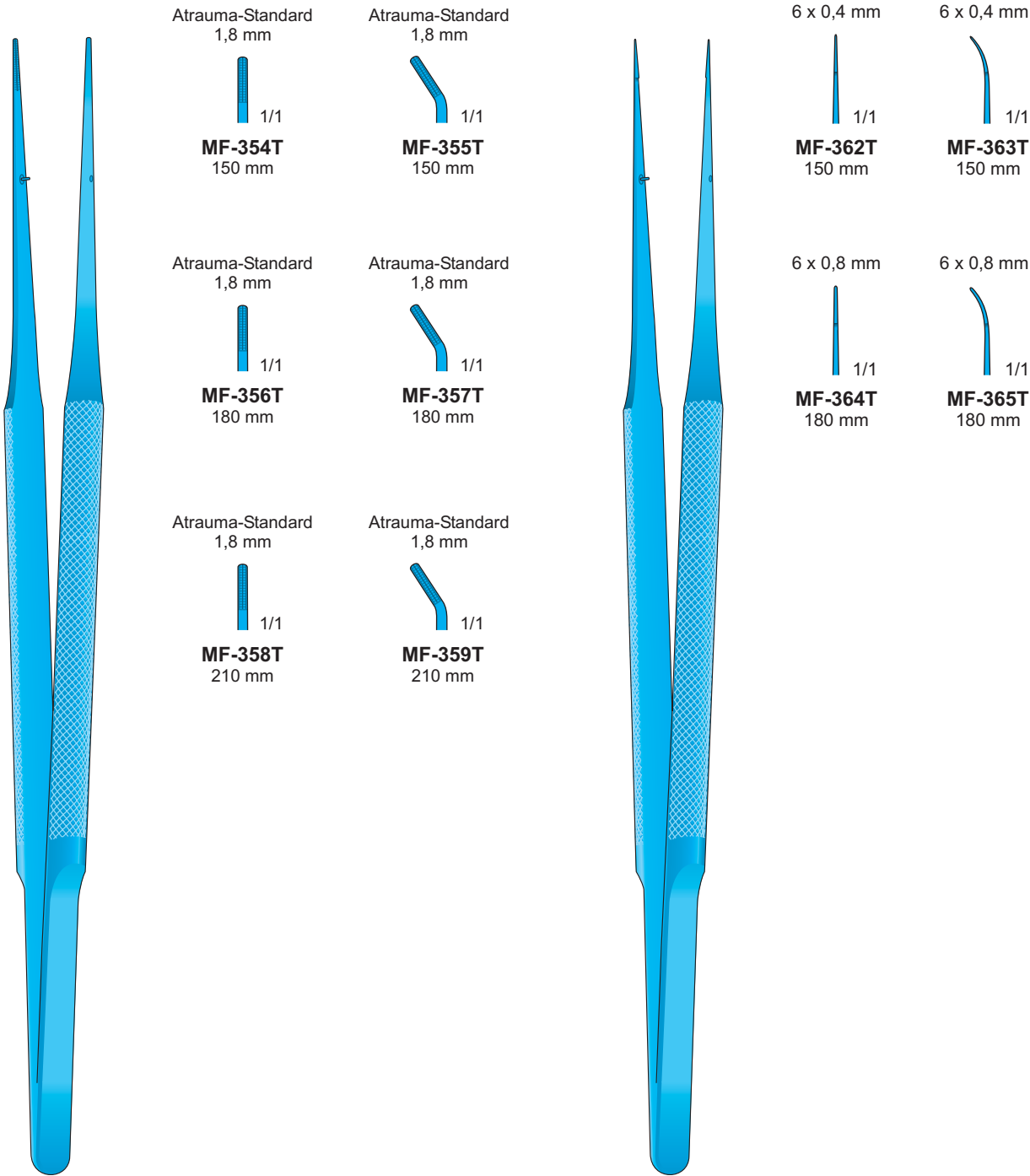

Atrauma-Standard
1,8 mm

Atrauma-Standard
1,8 mm

6 x 0,4 mm

6 x 0,4 mm

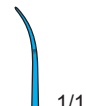
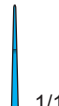

MF-354T
150 mm

MF-355T
150 mm

MF-362T
150 mm

MF-363T
150 mm

Atrauma-Standard
1,8 mm

Atrauma-Standard
1,8 mm

6 x 0,8 mm

6 x 0,8 mm

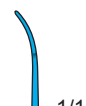
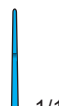

MF-356T
180 mm

MF-357T
180 mm

MF-364T
180 mm

MF-365T
180 mm

Atrauma-Standard
1,8 mm

Atrauma-Standard
1,8 mm



MF-358T
210 mm

MF-359T
210 mm

MF-354T/MF-359T

MF-362T/MF-365T

Mikro Pinzetten

Delicate forceps

Micro pinzette

Pinzas finos

Micro pinces

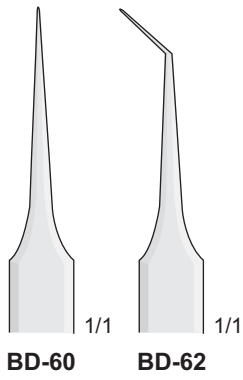
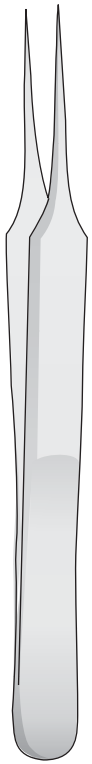

BD-60

BD-62

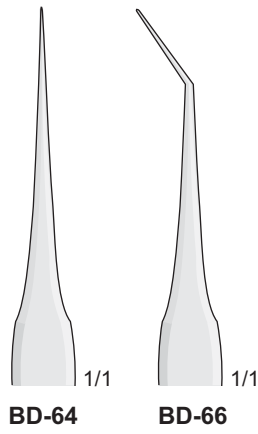
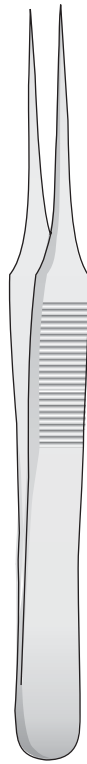

BD-64

BD-66

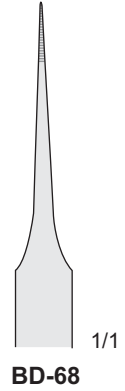

BD-68

BD-60/BD-62
110 mm

BD-64/BD-66
110 mm

BD-68
90 mm

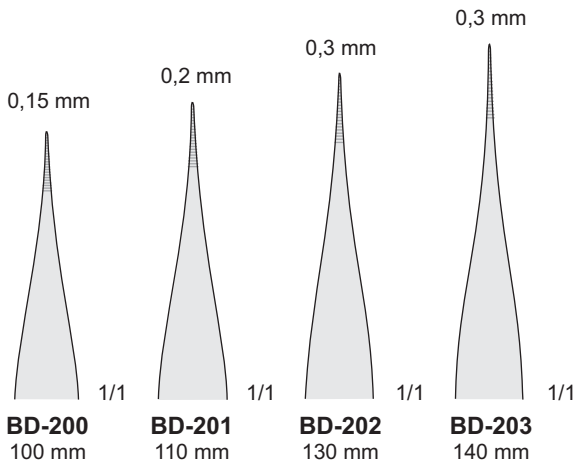
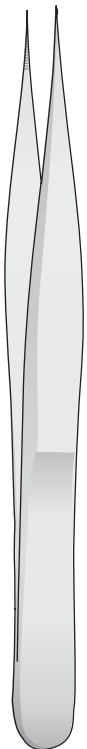

BD-200
100 mm

BD-201
110 mm

BD-202
130 mm

BD-203
140 mm

BD-200/BD-203



BD-205
115 mm

BD-206
115 mm

Feine Pinzetten

Delicate forceps

Pinzette delicate

Pinzas delicadas

Pincas d elicates

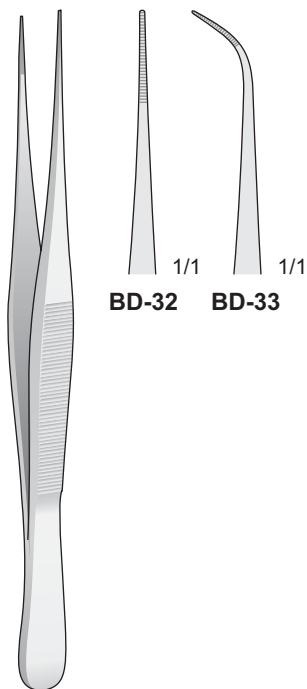

BD-32 **BD-33**

BD-32/BD-33
100 mm

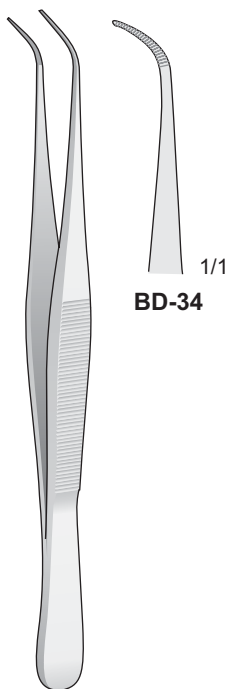

BD-34

BD-34
100 mm

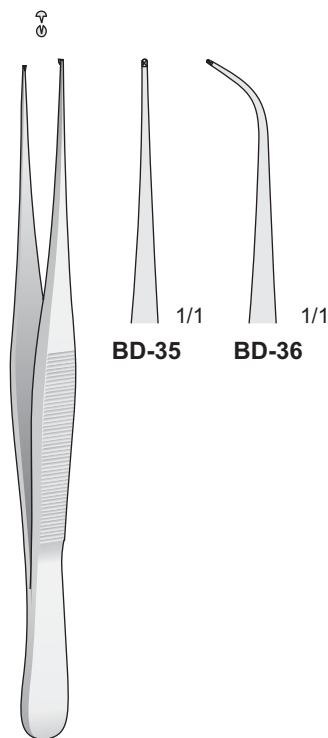

BD-35 **BD-36**

BD-35/BD-36
100 mm

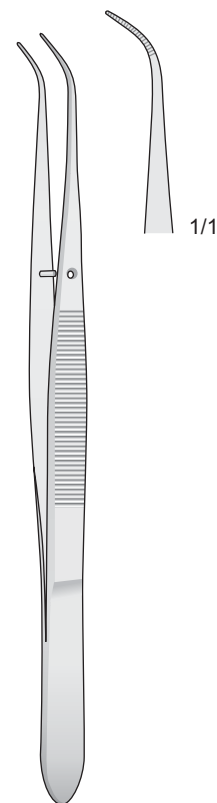

PERRY
BD-05
125 mm

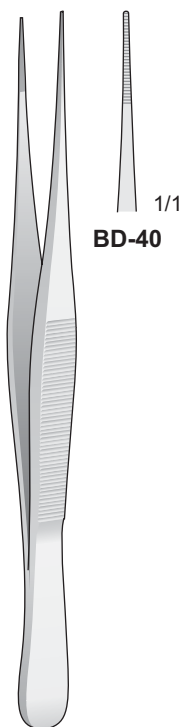

BD-40

BD-40
110 mm

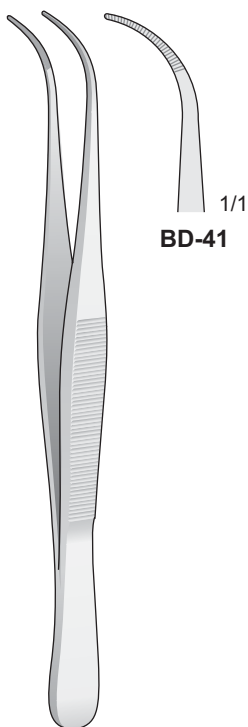

BD-41

BD-41
110 mm

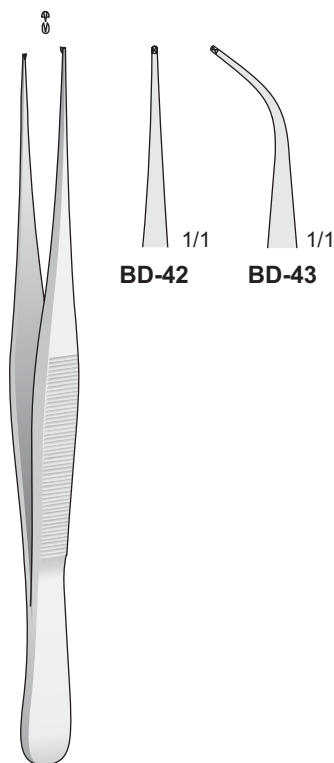

BD-42 **BD-43**

BD-42/BD-43
110 mm

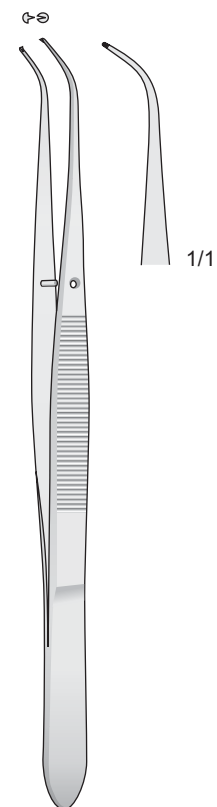

PERRY
BD-06
125 mm

Chirurgische Pinzetten

Tissue forceps

Pinzette chirurgiche

Pinzas quirúrgicas

Pinces chirurgicales

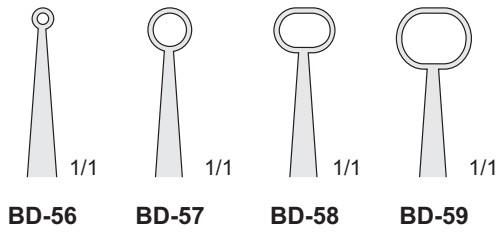
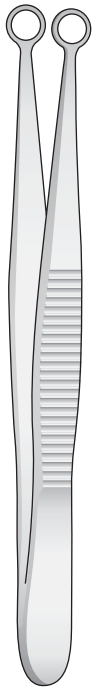

BD-56/BD-59
100 mm



1x2 denti
0,2 mm
1/1
BD-238
95 mm

BD-238
95 mm

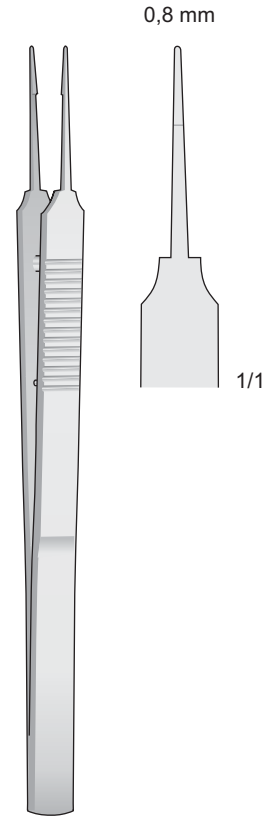

**AUSTIN
BD-239**
140 mm

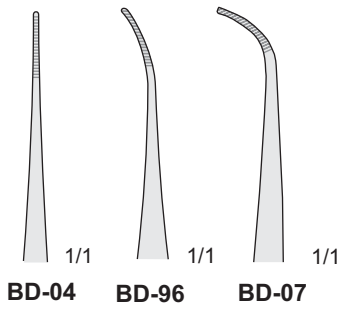
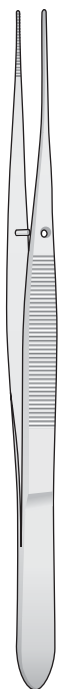

**GRAEFE
BD-04/BD-96**
100 mm

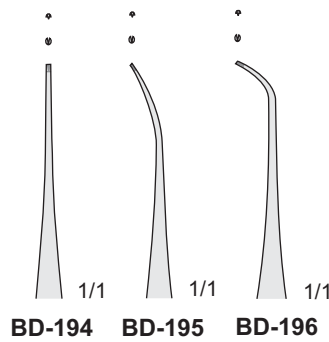

**GRAEFE
BD-194/BD-196**
100 mm

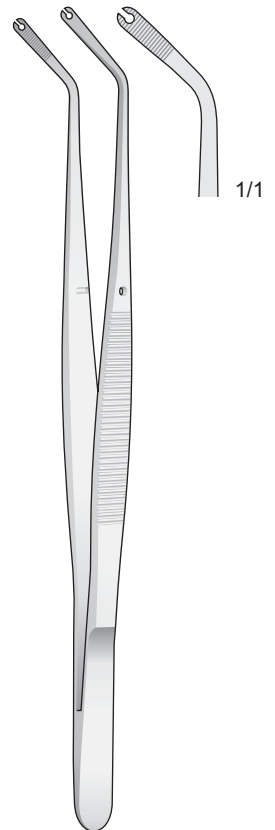

**CORN
DA-07**
150 mm

Chirurgische Pinzetten

Tissue forceps

Pinzette chirurgiche

Pinzas quirúrgicas

Pinces chirurgicales

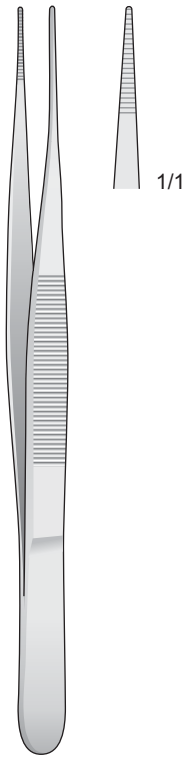

**SEMKEN
BD-145**
130 mm

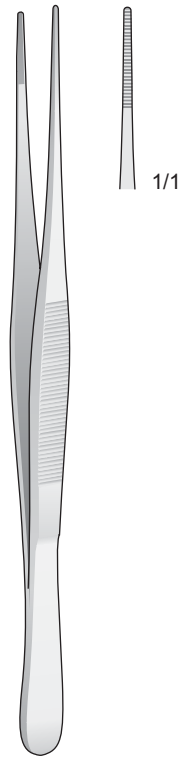

**SEMKEN
BD-44**
130 mm

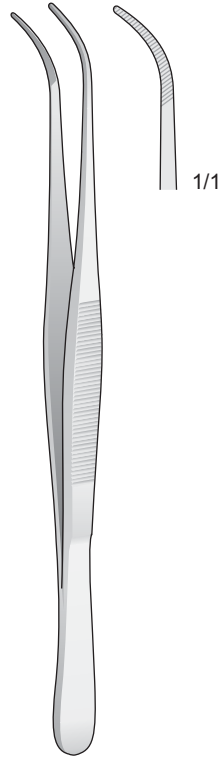

**SEMKEN
BD-45**
130 mm

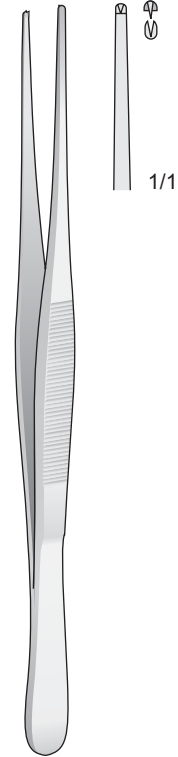

**SEMKEN
BD-46**
130 mm

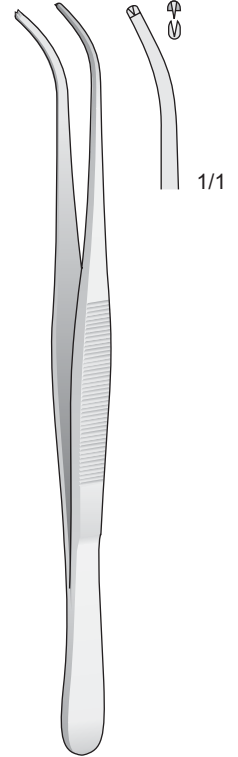

**SEMKEN
BD-47**
130 mm

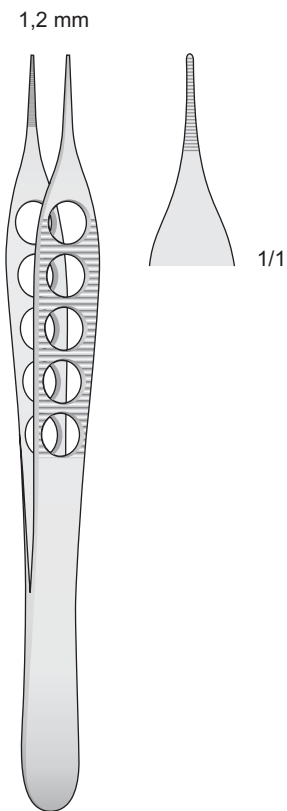

**ADSON
BD-207**
120 mm

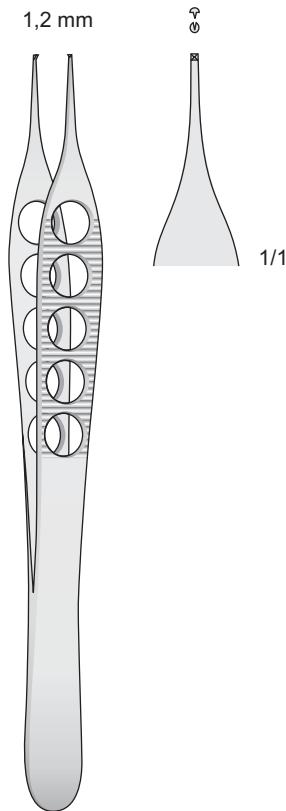

**ADSON
BD-208**
120 mm

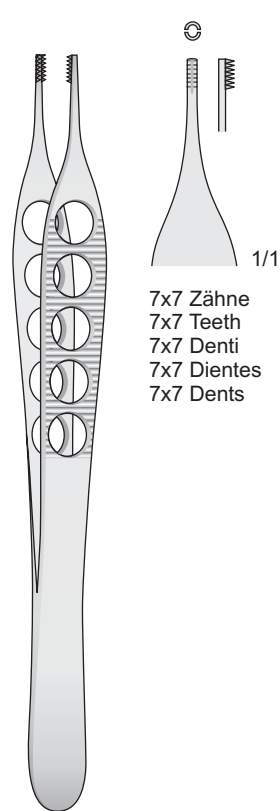

**ADSON-BROWN
BD-209**
120 mm

7x7 Zähne
7x7 Teeth
7x7 Denti
7x7 Dientes
7x7 Dents

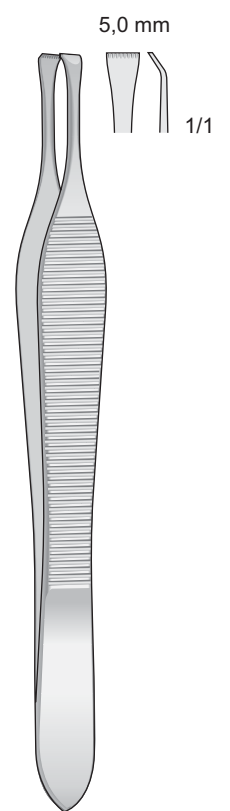

**BEASLEY-BABCOCK
BD-51**
120 mm

Chirurgische Pinzetten

Tissue forceps

Pinzette chirurgiche

Pinzas quirúrgicas

Pinces chirurgicales

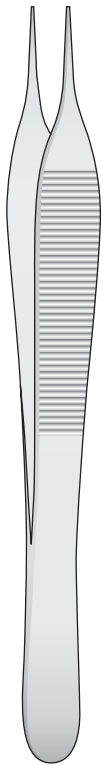

ADSON
BD-30/BD-73

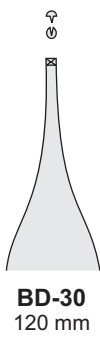

BD-30
120 mm

1/1

Mikro - Micro

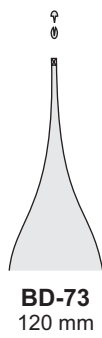

BD-73
120 mm

1/1

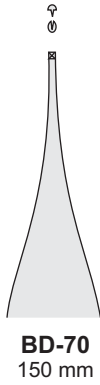

BD-70
150 mm

1/1

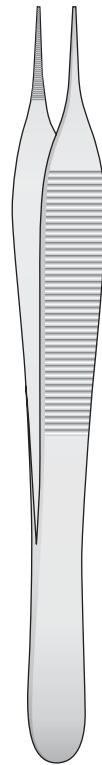

ADSON
BD-31/BD-72



BD-31
120 mm

1/1

Mikro - Micro



BD-71
120 mm

1/1

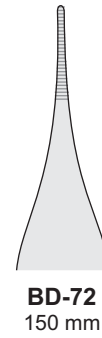

BD-72
150 mm

1/1

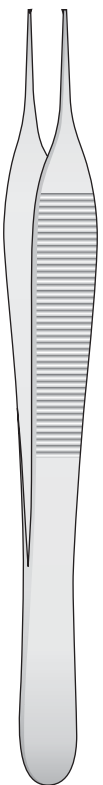

ADSON
BD-177/BD-178
150 mm

Mikro - Micro

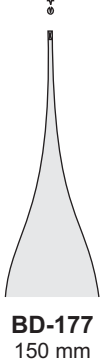

BD-177
150 mm

1/1



BD-178
150 mm

1/1

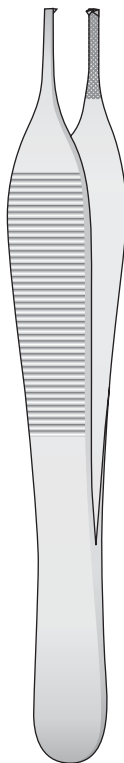

ADSON
BD-90
120 mm

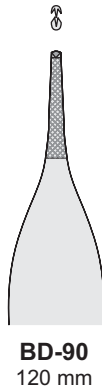

BD-90
120 mm

1/1



ADSON-BROWN
BD-92/BD-141
120 mm

6x6 Zähne
6x6 Teeth
6x6 Denti
6x6 Dientes
6x6 Dents



BD-92
120 mm

1/1

9x9 Zähne
9x9 Teeth
9x9 Denti
9x9 Dientes
9x9 Dents



BD-141
120 mm

1/1

6x6 Zähne
6x6 Teeth
6x6 Denti
6x6 Dientes
6x6 Dents



BD-93
120 mm

1/1

Anatomische Pinzetten

Dressing forceps

Pinzette anatomiche

Pinzas anatómicas

Pinces anatómicas

Standard

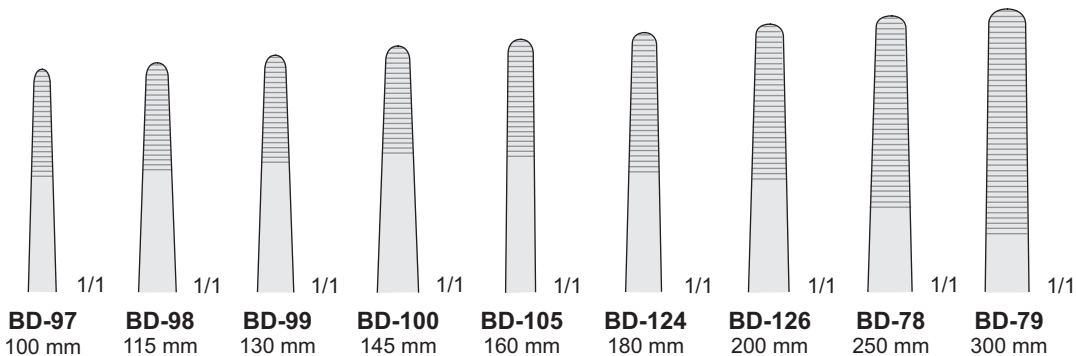

BD-78/BD-126



Mod. Fine

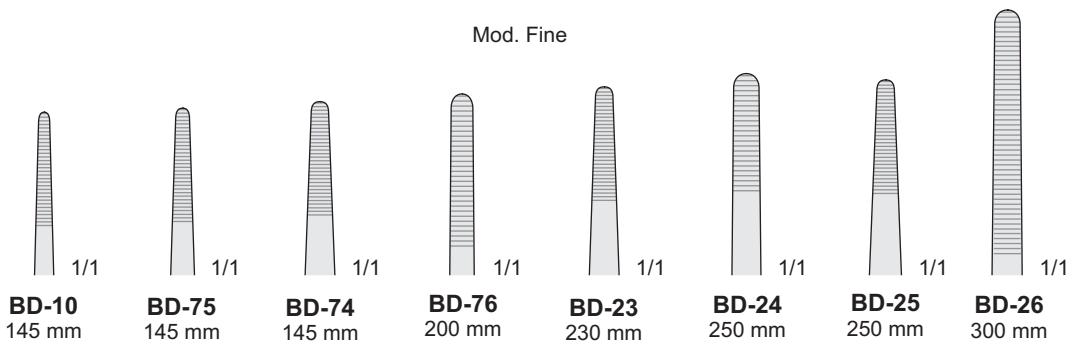

BD-10/BD-76

Anatomische Pinzetten

Dressing forceps

Pinzette anatomiche

Pinzas anatómicas

Pincas anatomiques

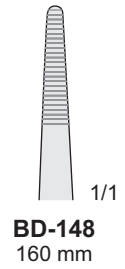
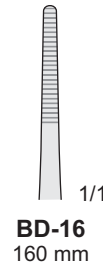
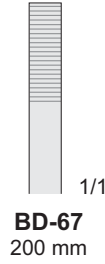
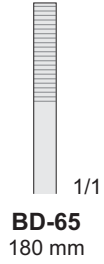
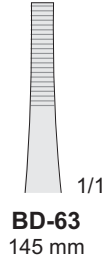
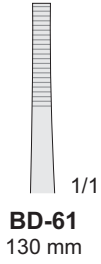

STILLE
BD-61/BD-67

BD-16/BD-148
160 mm

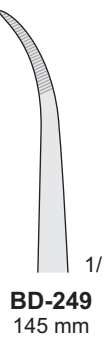
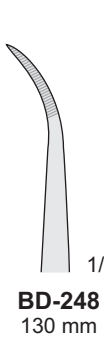
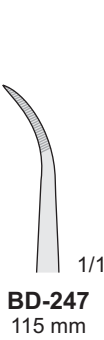
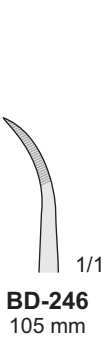
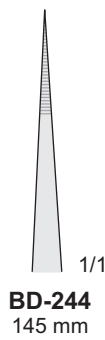
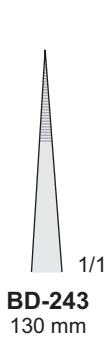
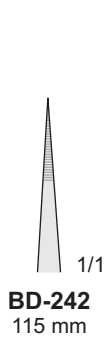

BD-240/BD-249

Chirurgische Pinzetten

Tissue forceps

Pinzette chirurgiche

Pinzas quirúrgicas

Pinces chirurgicales



1x2 Zähne
1x2 Teeth
1x2 Denti
1x2 Dientes
1x2 Dents

Standard

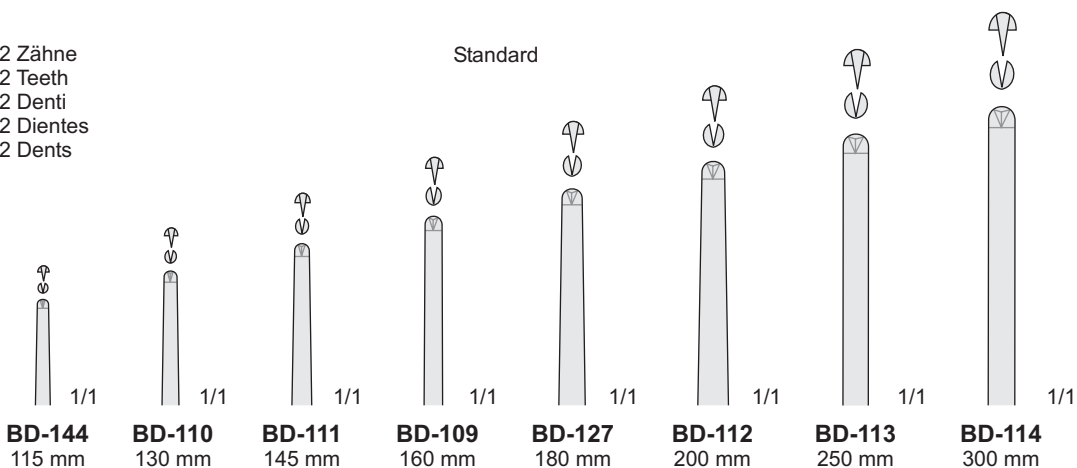

BD-109/BD-144



1x2 Zähne
1x2 Teeth
1x2 Denti
1x2 Dientes
1x2 Dents

Schmal - Narrow - Strette - Estrechas - Étroites

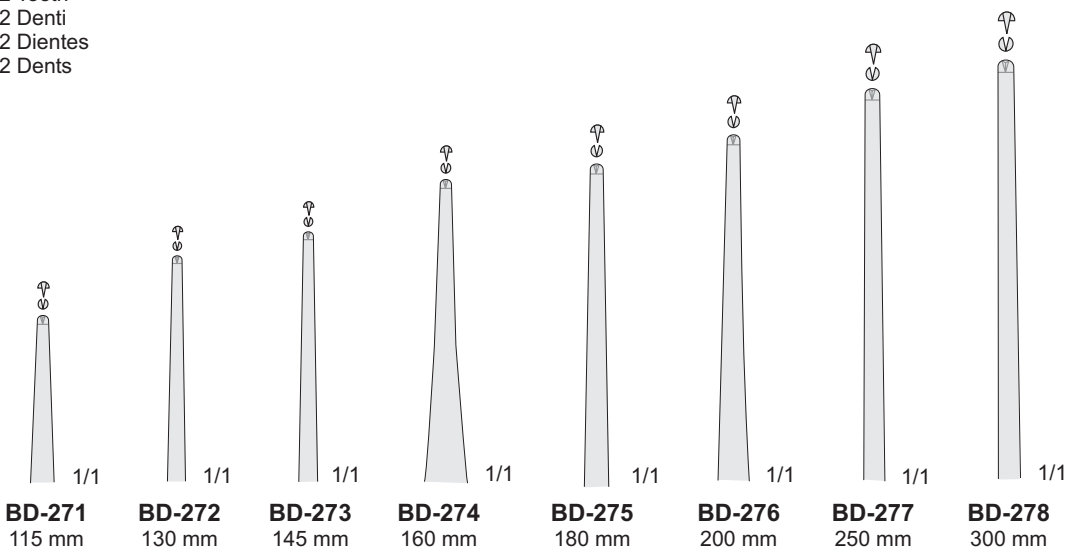

BD-271/BD-278

Chirurgische Pinzetten

Tissue forceps

Pinzette chirurgiche

Pinzas quirúrgicas

Pinces chirurgicales

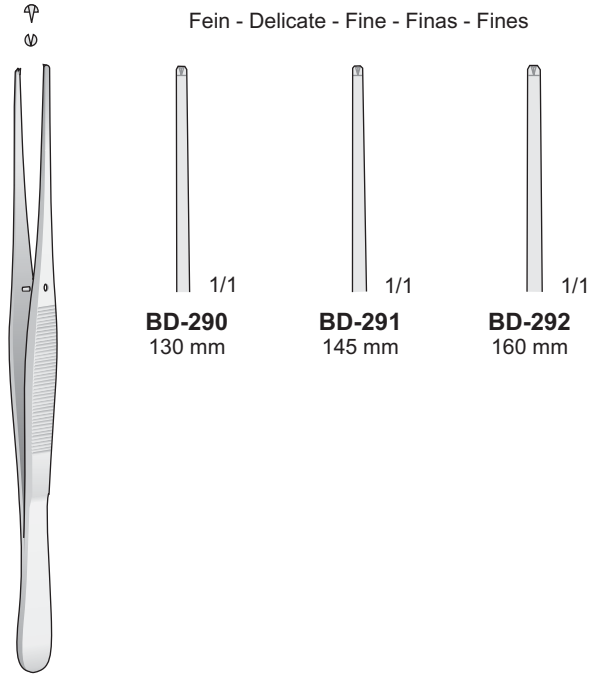
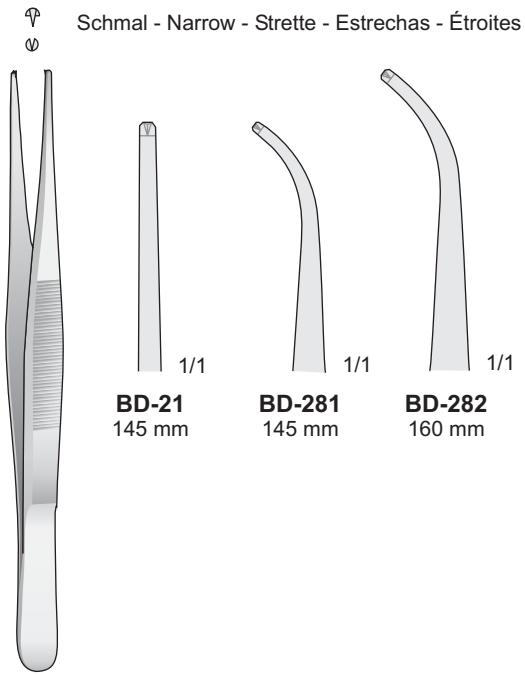

BD-21/BD-282

1 x 2 Zähne
1 x 2 Teeth
1 x 2 Denti
1 x 2 Dientes
1 x 2 Dents

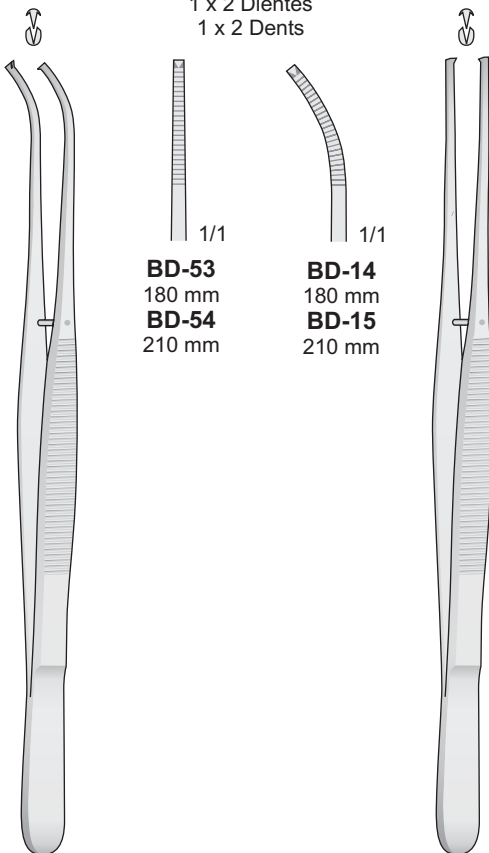

POTTS-SMITH
BD-14/BD-54

BD-290/BD-292

1 x 2 Zähne
1 x 2 Teeth
1 x 2 Denti
1 x 2 Dientes
1 x 2 Dents

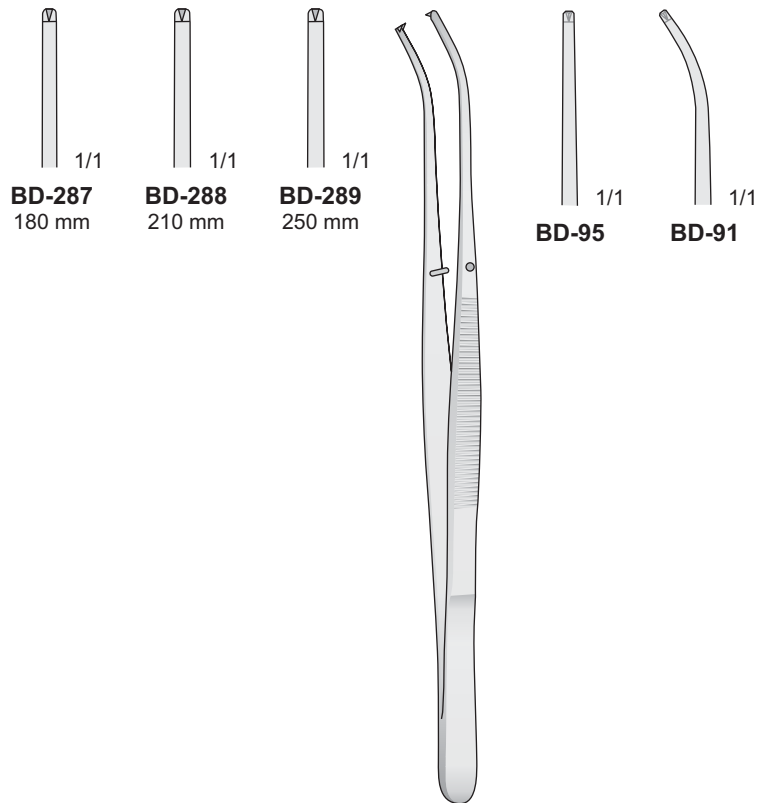

SEMKEN
BD-91/BD-95
150 mm

Chirurgische Pinzetten

Tissue forceps

Pinzette chirurgiche

Pinzas quirúrgicas

Pinces chirurgicales

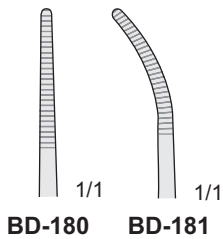

CUSHING
BD-180/BD-181
175 mm

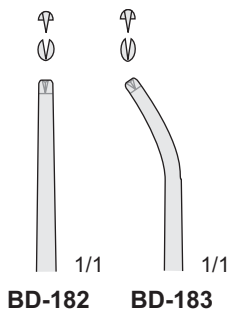

CUSHING
BD-182/BD-183
175 mm

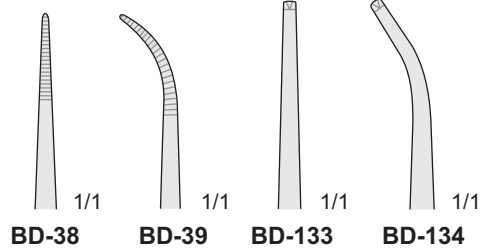

BD-38/BD-134
200 mm

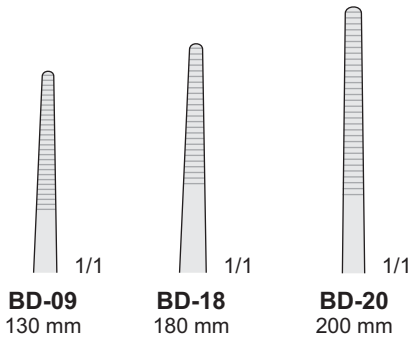

BD-09/BD-20

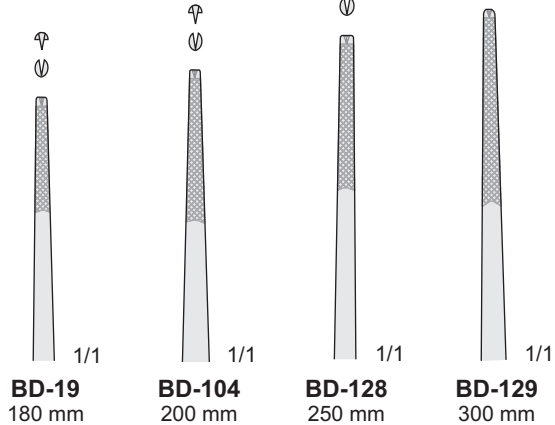

BD-19/BD-129

Chirurgische Pinzetten

Tissue forceps

Pinzette chirurgiche

Pinzas quirúrgicas

Pinces chirurgicales



2 x 3 Zähne - 2 x 3 Teeth - 2 x 3 Denti
2 x 3 Dientes - 2 x 3 Dents



1/1

BD-106
115 mm



1/1

BD-138
145 mm



1/1

BD-107
160 mm



1/1

BD-139
180 mm



1/1

BD-108
200 mm

BD-106/BD-139



3 x 4 Zähne - 3 x 4 Teeth - 3 x 4 Denti
3 x 4 Dientes - 3 x 4 Dents



1/1

BD-115
145 mm



1/1

BD-119
160 mm



1/1

BD-116
200 mm



1/1

BD-117
250 mm



4 x 5 Zähne
4 x 5 Teeth
4 x 5 Denti
4 x 5 Dientes
4 x 5 Dents



1/1

BD-118
145 mm



1/1

BD-149
160 mm



BD-115/BD-119

BD-118/BD-149

Chirurgische Pinzetten

Tissue forceps

Pinzette chirurgiche

Pinzas quirúrgicas

Pinces quirúrgicas



GERALD
MF-101
180 mm

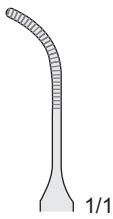

GERALD
MF-102
180 mm

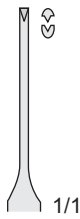

GERALD
MF-103
180 mm

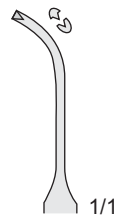

GERALD
MF-104
180 mm

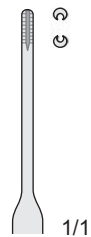

GERALD-BROWN
MF-105
180 mm

Atraumatische Pinzetten

Atraumatic Forceps

Pinzette atraumatiche

Pinzas Atraumáticas

Pinces Atraumatiques

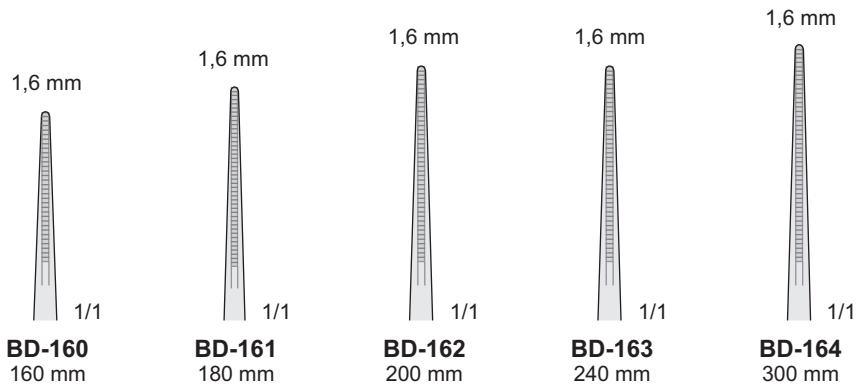

Atraumatische Pinzetten
Atraumatic Forceps
Pinzette atraumatiche
Pinzas atraumáticas
Pinces atraumatiques

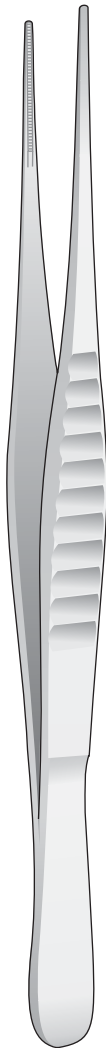

DE BAKEY
BD-80/BD-164

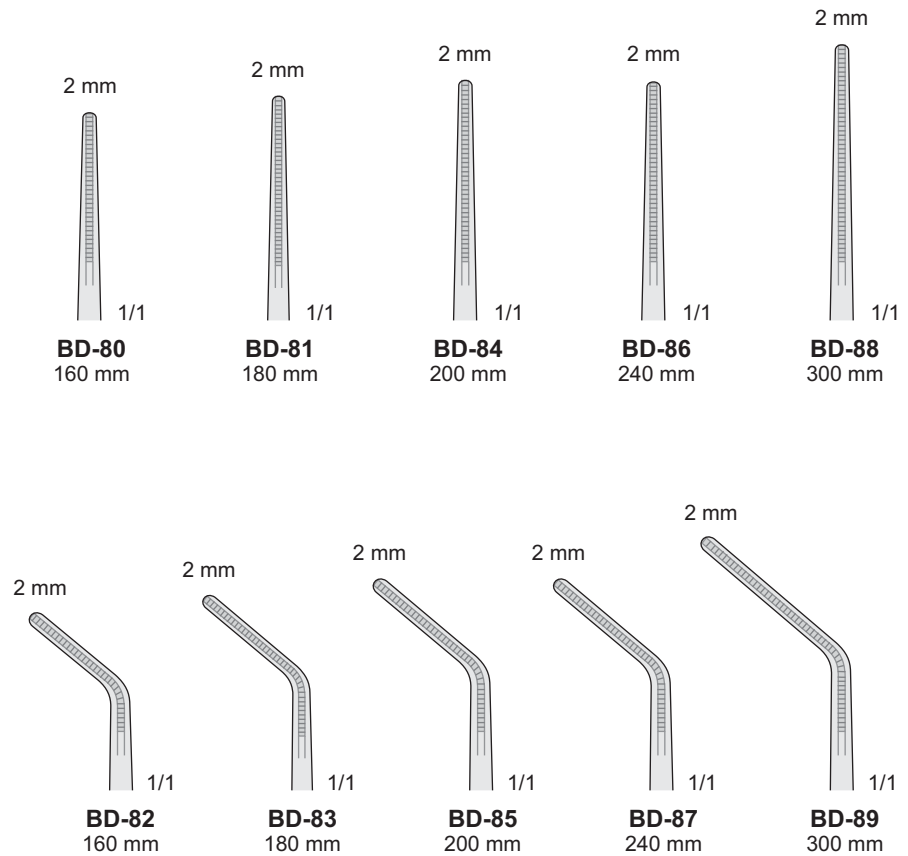

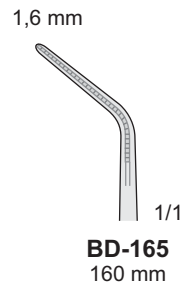

Atraumatische Pinzetten
Atraumatic Forceps
Pinzette atraumatiche
Pinzas atraumáticas
Pinces atraumatiques

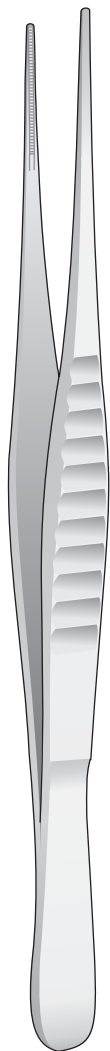

DE BAKEY
BD-165/BD-173

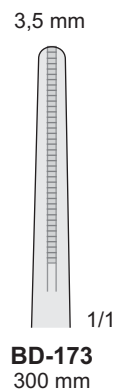
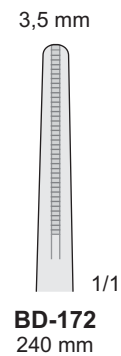
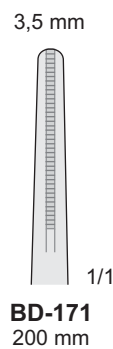
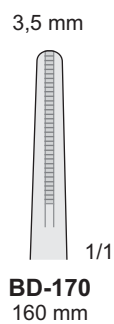
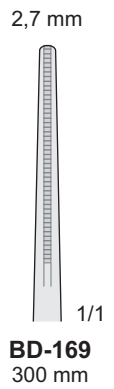
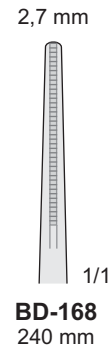
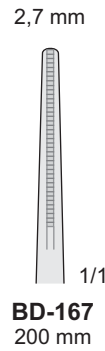
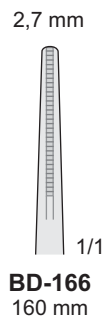

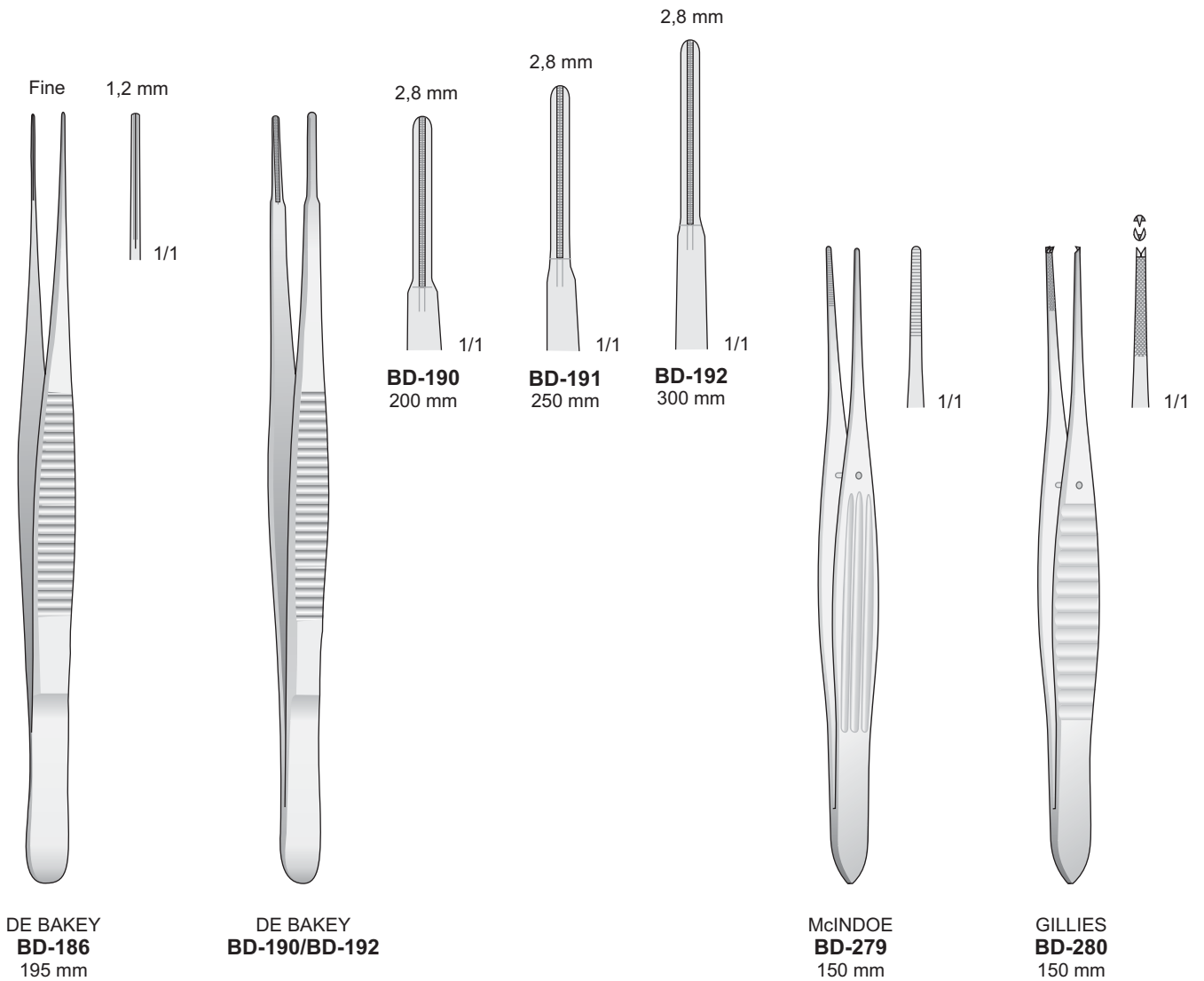

Mikro Pinzetten

Delicate forceps

Micro pinzette

Pinzas finos

Micro pinces

Fixier und Fasspinzetten - Fixation and Grasping forceps
Pinze da Fissazione - Pinzas de fijación y de aprehensión
Pinces pour saisir les tissus

Columella-Klemmen - Columella forceps
Pinzetta-Columella con stop - Pinzas para Columella
Pinces pour Columelle



5 mm

1/1
BD-333

10 mm

1/1
BD-334

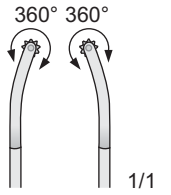

**GRAEFE
BD-135**
110 mm

**GRAEFE
BD-136**
110 mm

**GREEN
BD-333/BD-334**
100 mm

**COTTLE
BD-140**
100 mm

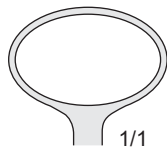
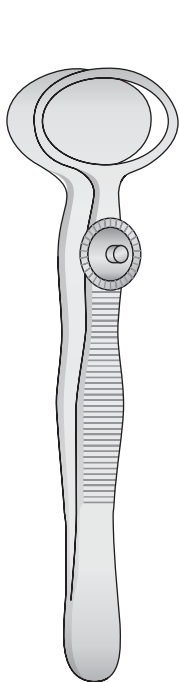
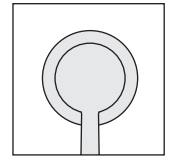
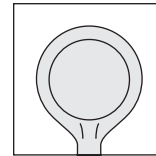
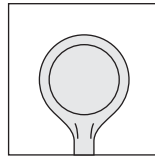

1/1
BD-130
20 mm

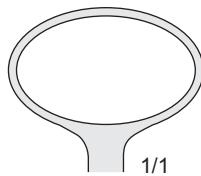

1/1
BD-131
26 mm

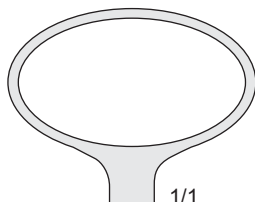

1/1
BD-132
31 mm

**DESMARRES
BD-130/BD-132**
90 mm

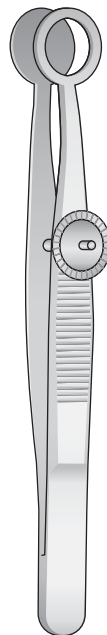

**LAMBERT
BD-260**
90 mm



**HUNT
BD-261**
95 mm



**AYERS
BD-263**
90 mm

Chirurgische Pinzetten

Tissue forceps

Pinzette chirurgiche

Pinzas quirúrgicas

Pinces chirurgicales

Dressing Forceps
criss-cross serrated tips

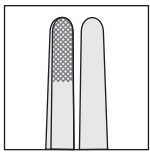

BISHOP-HARMON
MF-175
85 mm

Tissue Forceps
1x2 Teeth

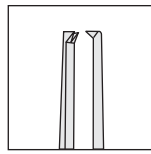

BISHOP-HARMON
MF-176 0,3 mm
MF-177 0,6 mm
85 mm

Iris Forceps
serrated jaws

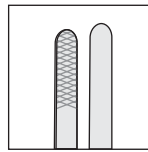

GRAEFE
MF-178 Straight
MF-179 Curved
65 mm

Iris Forceps
1x2 Teeth

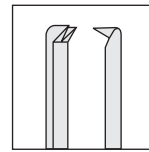

GRAEFE
MF-180 Straight
MF-181 Curved
65 mm

Micro Iris Forceps
straight, ultra fine shanks
with 1x2 teeth, 0,12 mm

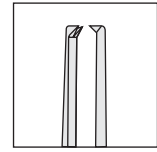

BONN
MF-182 75 mm

Ultra fine 5 mm
Straight

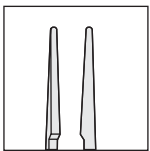

MF-150
100 mm

Suturing Forceps
1x2 teeth of 0,12 mm set at 90°,
extra delicate platform

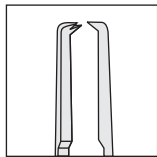

TENNANT
MF-230
100 mm

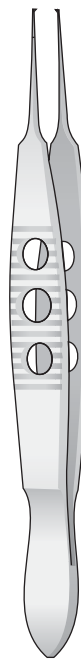
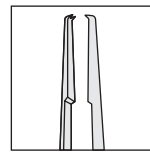

MC PHERSON
MF-235
105 mm

1x2 curved teeth

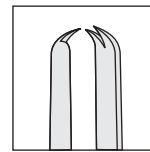

KUHNT
BD-255
110 mm

1x2 angular teeth

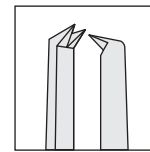

ELSCHNIG
BD-256 0,6 mm
105 mm

Chirurgische Pinzetten

Tissue forceps

Pinzette chirurgiche

Pinzas quirúrgicas

Pinces chirurgicales

Mit Hartmetalleinsätzen - Tungsten-carbide forceps
Con punta al carburo di tungsteno - Pinzas con tungsteno
Avec plaquettes en carbure de tungstène

Pinzette mit Häkchen
Suturing Forceps
Pinzette per suture

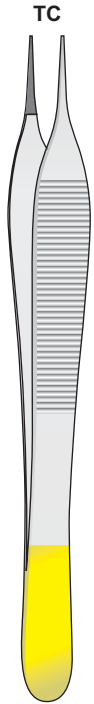

ADSON
BD-230/BD-231

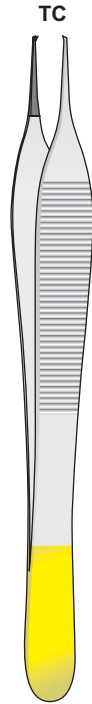
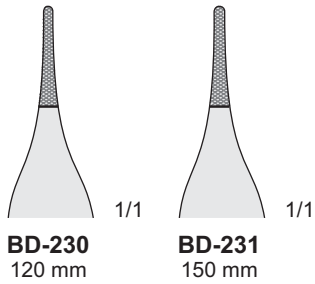

ADSON
BD-250/BD-251

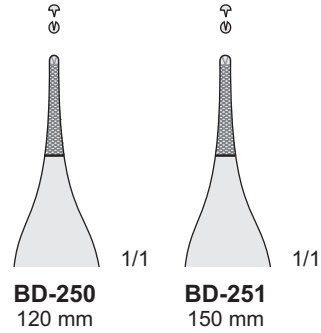

ADSON
BD-300
125 mm



BD-210/BD-215

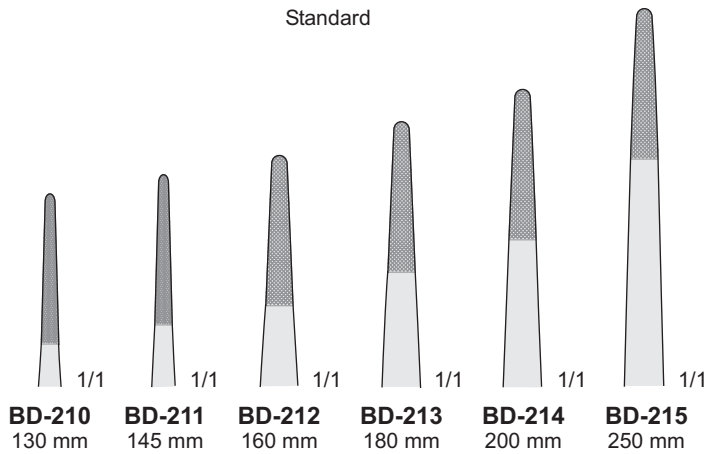

SEMKEN
BD-216/BD-217

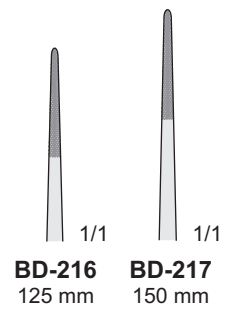

Chirurgische Pinzetten

Tissue forceps

Pinzette chirurgiche

Pinzas quirúrgicas

Pinces chirurgicales



WANGENSTEEN
BD-232/BD-234

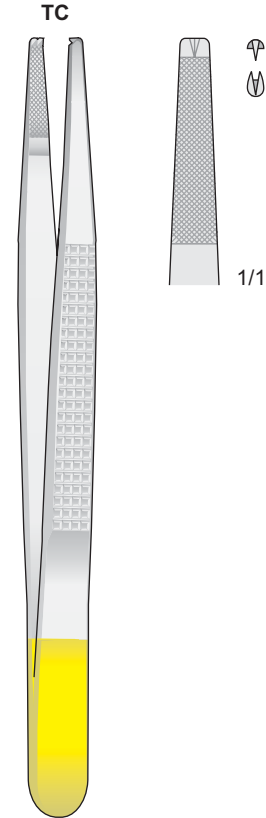
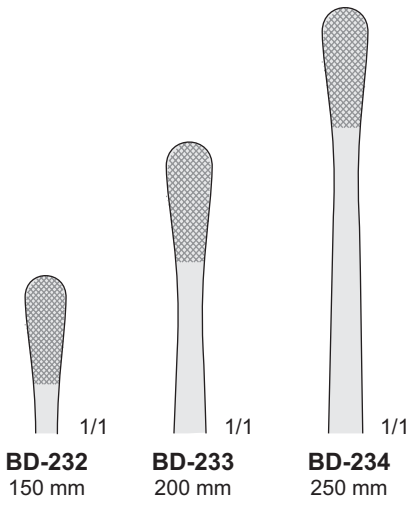

BONNEY
BD-252
180 mm



CUSHING
BD-226/BD-227
175 mm

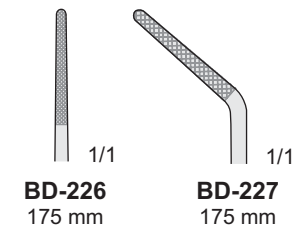

Mit Dissektor-Ende
With Dissector End
Con dissettore
Con cabo disecador
Avec bout disecteur



POTTS-SMITH
BD-218/BD-220

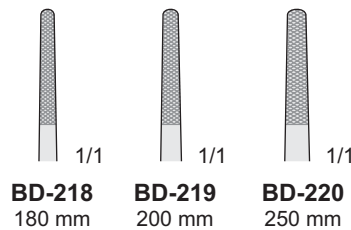

Mit Dissektor-Ende
With Dissector End
Con dissettore
Con cabo disecador
Avec bout disecteur

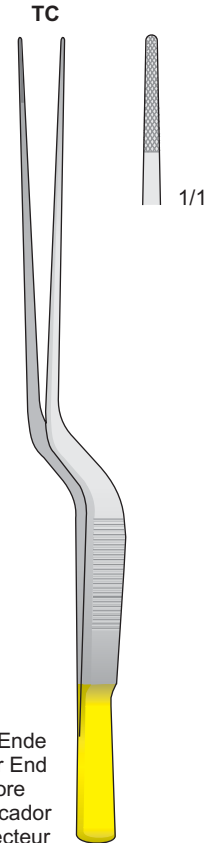

TAYLOR
BD-228
185 mm

Mit Dissektor-Ende
With Dissector End
Con dissettore
Con cabo disecador
Avec bout disecteur

Chirurgische Pinzetten

Tissue forceps

Pinzette chirurgiche

Pinzas quirúrgicas

Pinces chirurgicales

Mit Hartmetalleinsätzen - Tungsten-carbide forceps
Con punta al carburo di tungsteno - Pinzas con tungsteno
Avec plaquettes en carbure de tungstène

TC

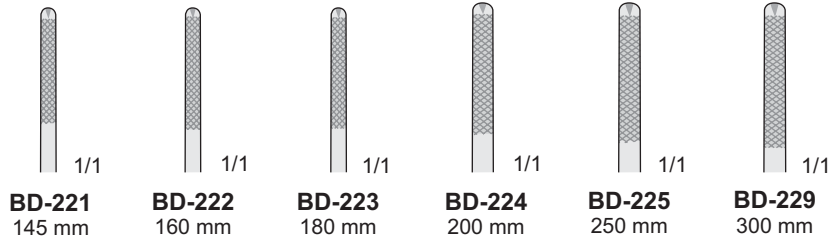

BD-221/BD-229

Titan - Titanium - Titanio - Titane

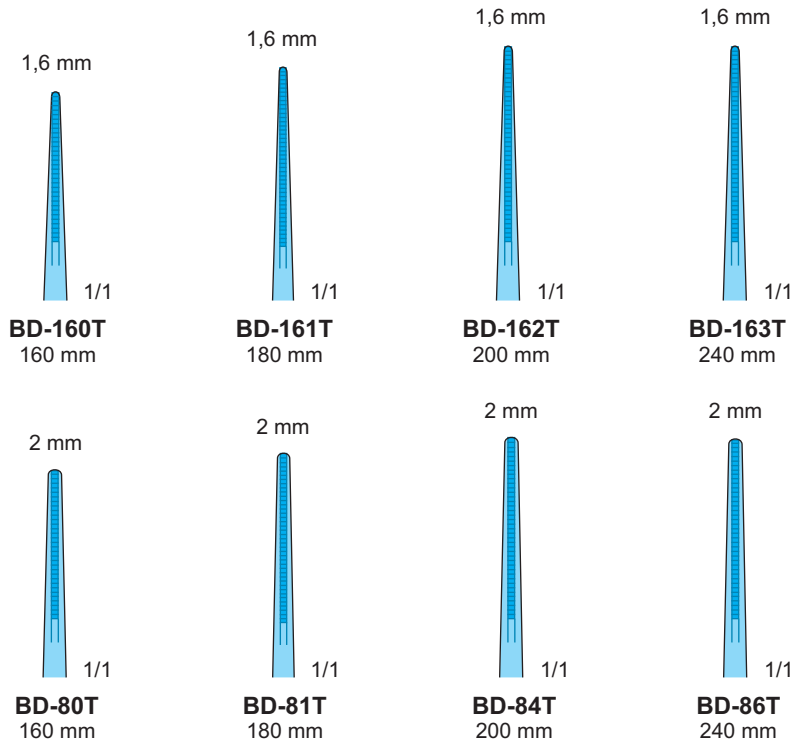

DE BAKEY
BD-80T/BD-163T

Chirurgische Pinzetten

Tissue forceps

Pinzette chirurgiche

Pinzas quirúrgicas

Pinces chirurgicales

Titan - Titanium - Titanio - Titane

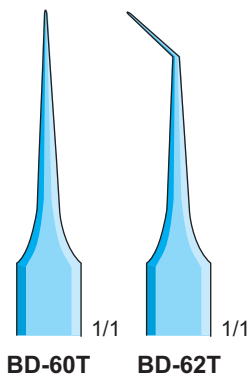
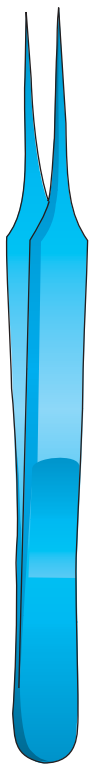

BD-60T/BD-62T
110 mm

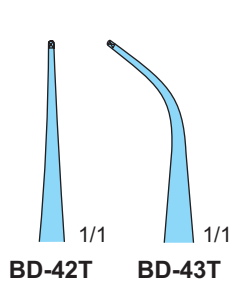

BD-42T/BD-43T
110 mm

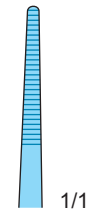

BD-09T
130 mm

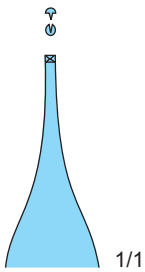
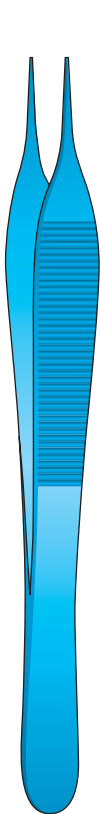

**ADSON
BD-30T**
120 mm

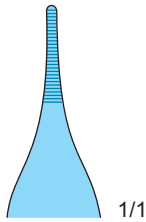
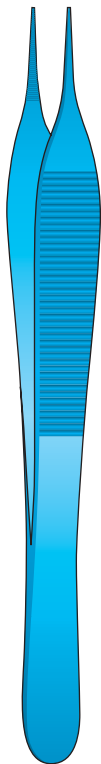

**ADSON
BD-31T**
120 mm

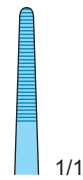

BD-75T
145 mm

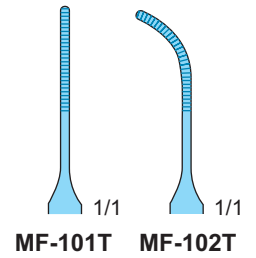

**GERALD
MF-101T/MF-102T**
180 mm

Ohr Pinzetten

Ear forceps

Pinzette auricolari

Pinzas auriculares

Pinces auriculaires

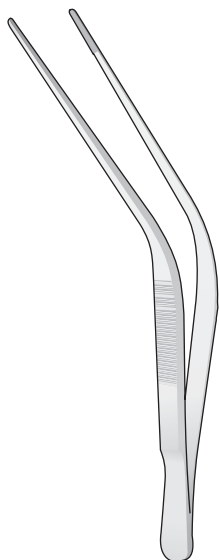

TROELTSCH
BD-22
110 mm



TROELTSCH
BD-146
110 mm

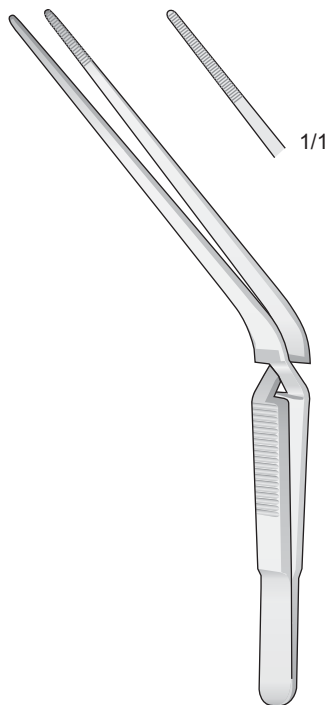

TROELTSCH
BD-179
130 mm



LUCAE
BD-147
140 mm

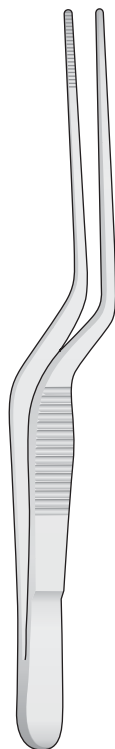

LUCAE
BD-101
140 mm

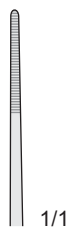

JANSEN
BD-102
160 mm

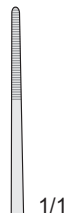

GRÜNWARD
BD-193
200 mm

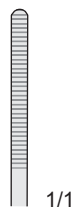

Cilienpinzetten

Cilia forceps

Pinzette Depilatorie

Pinzas depilatorias

Pinces à épiler les cils

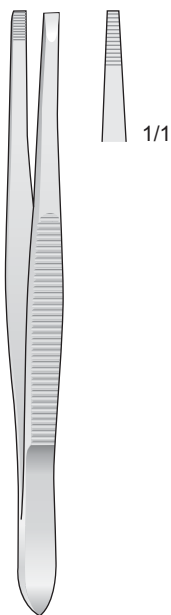

ES-45
90 mm

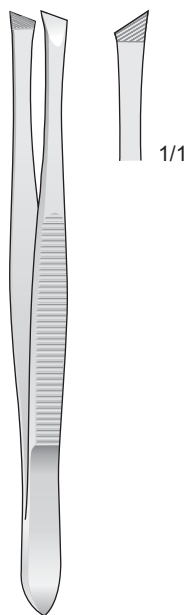

ES-46
90 mm

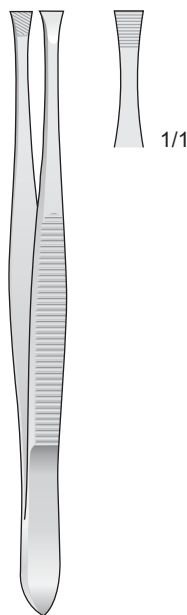

LITTAUER
ES-64
85 mm

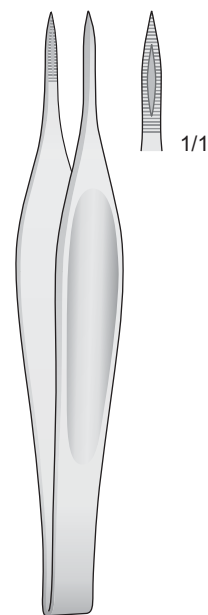

FEICHENFELD
BD-122
90 mm

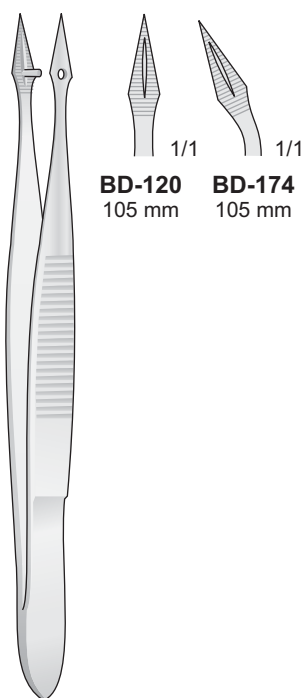
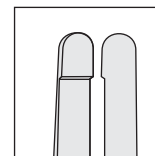
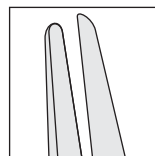
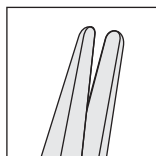

HUNTER
BD-120/BD-174

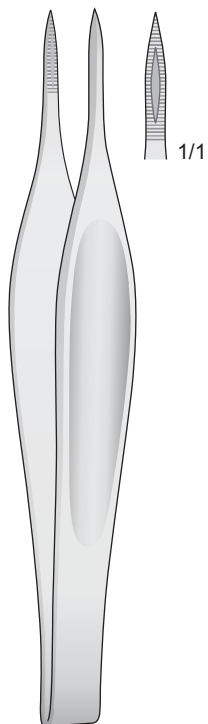

FEICHENFELD
BD-123
115 mm

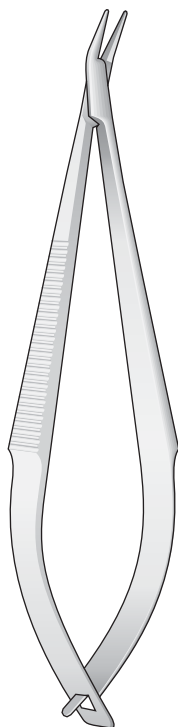

BEAUPRE
FD-117
110 mm

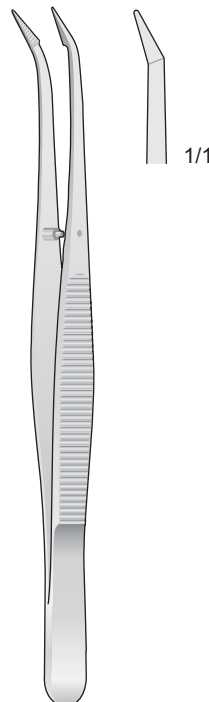

BARRAQUER
ES-65
105 mm

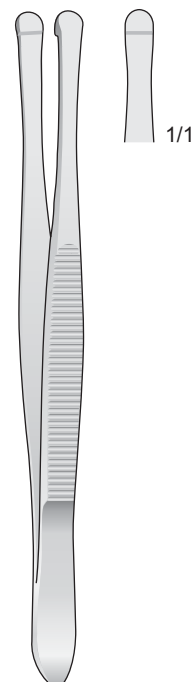

BEER
ES-48
90 mm

Demarcator

Face-Lift Klemmen
Face-Lift Forceps
Pinze per Face-Lift
Pinzas para Face-Lift
Pincas pour Face-Lift

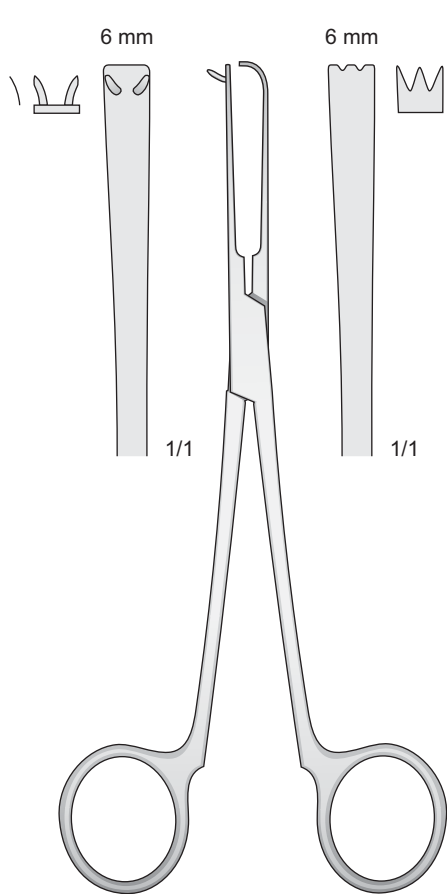

PITANGUI
ES-200
165 mm

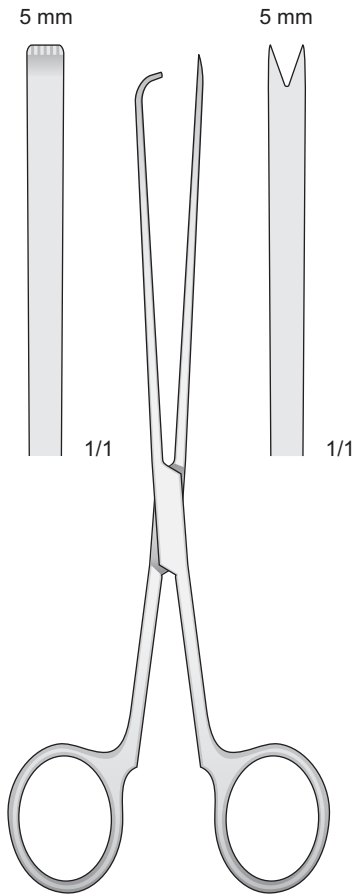

ES-201
165 mm

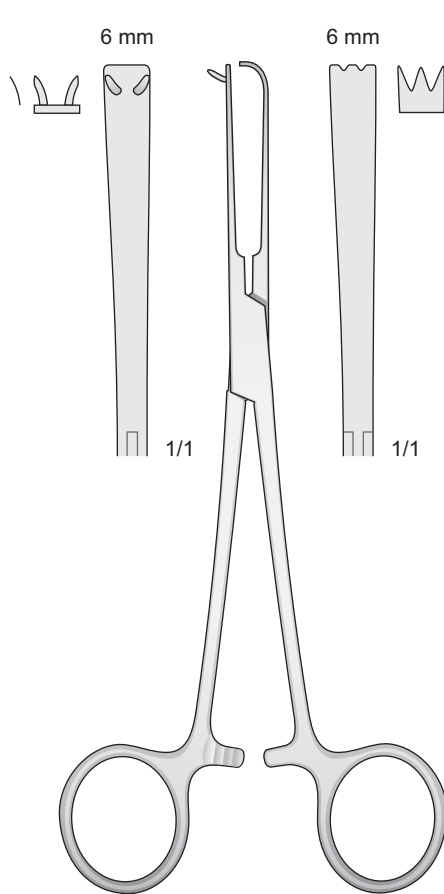

ES-202
165 mm

Gewebe und organ
Fasszangen

Gum and tissue
forceps

Pinze per afferrare
i tessuti

Pinzas para coger las
encias

Pincers pour saisir les
tissue

4 x 5 Zähne
4 x 5 Teeth
4 x 5 Denti
4 x 5 Dientes
4 x 5 Dents

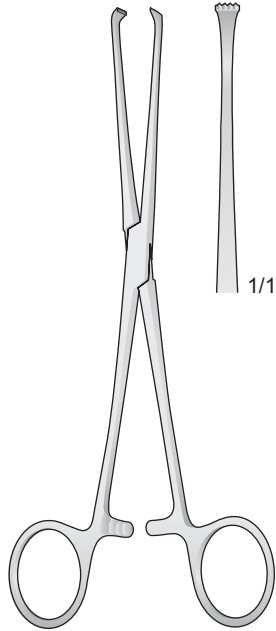

BABY-ALLIS
P-100
130 mm

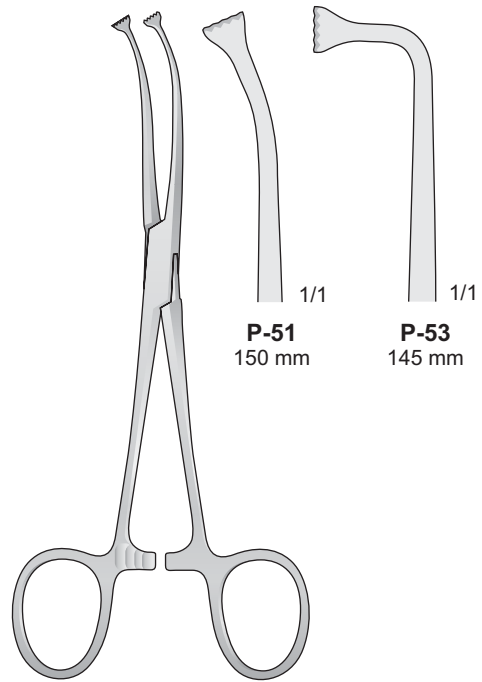

ALLIS
P-51/P-53

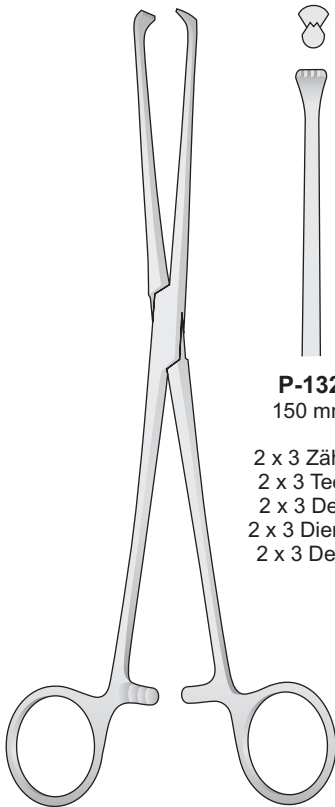

ALLIS
P-50/P-134

1/1	1/1	1/1	1/1	1/1	1/1	1/1
P-132 150 mm	P-133 150 mm	P-134 150 mm	P-50 160 mm	P-115 200 mm	P-119 220 mm	P-118 250 mm
2 x 3 Zähne 2 x 3 Teeth 2 x 3 Denti 2 x 3 Dientes 2 x 3 Dents	3 x 4 Zähne 3 x 4 Teeth 3 x 4 Denti 3 x 4 Dientes 3 x 4 Dents	4 x 5 Zähne 4 x 5 Teeth 4 x 5 Denti 4 x 5 Dientes 4 x 5 Dents	5 x 6 Zähne 5 x 6 Teeth 5 x 6 Denti 5 x 6 Dientes 5 x 6 Dents	5 x 6 Zähne 5 x 6 Teeth 5 x 6 Denti 5 x 6 Dientes 5 x 6 Dents	5 x 6 Zähne 5 x 6 Teeth 5 x 6 Denti 5 x 6 Dientes 5 x 6 Dents	5 x 6 Zähne 5 x 6 Teeth 5 x 6 Denti 5 x 6 Dientes 5 x 6 Dents

Fine-Arterienklemmen

Fine
Artery forceps

Pinze emostatiche
delicate

Pinzas hemostáticas
fino

Delicate
Pincas hémostatiques

Kopfhautklemme
Scalp Haemostatic forceps
Pinza emostatica per il cuoio capelluto
Pinza hemostáticas para pericraneo

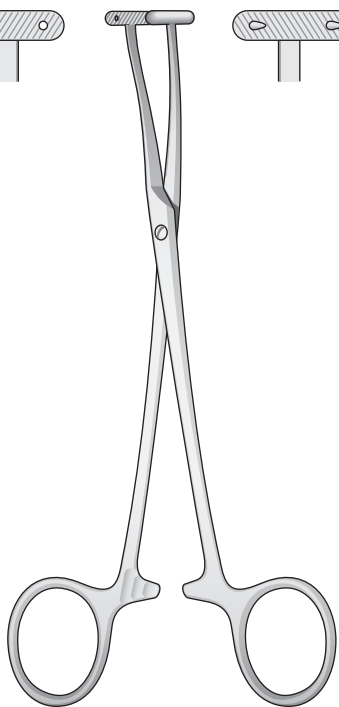

DE MARTEL
FB-120
180 mm

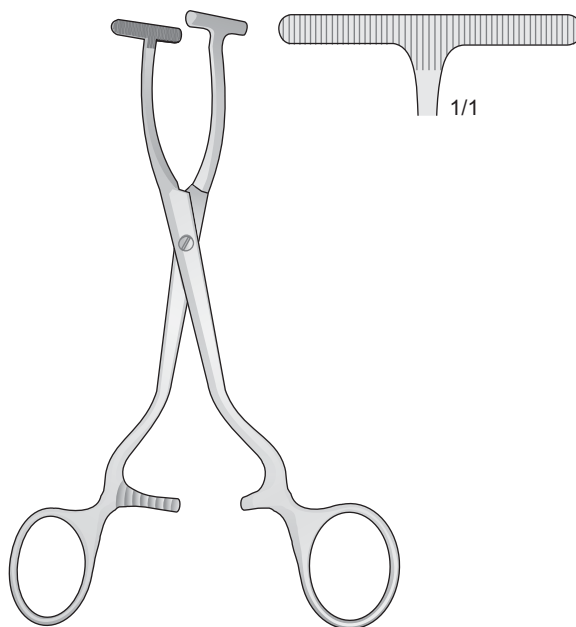

P-207
150 mm

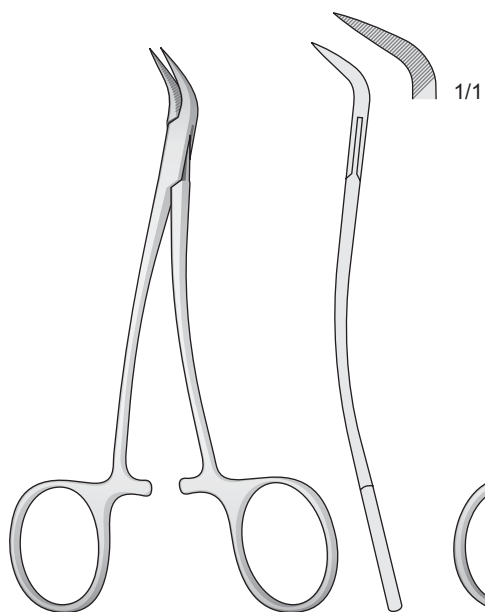

PEET
DR-40
120 mm

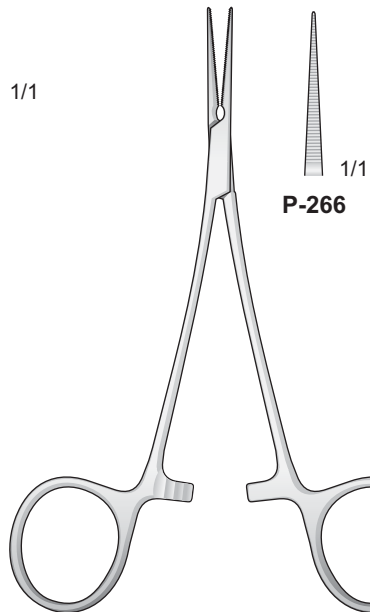

JACOBSON-MICRO
P-266
130 mm

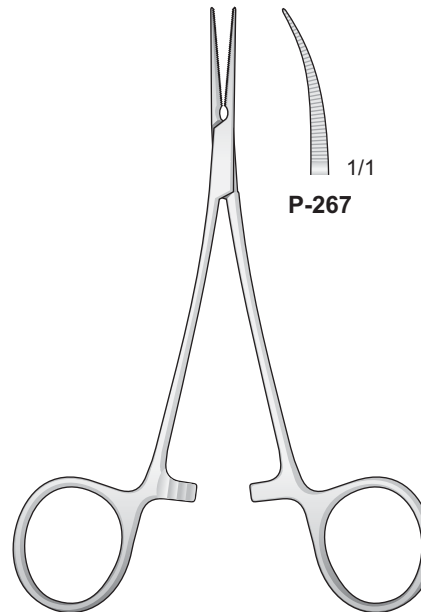

JACOBSON-MICRO
P-267
130 mm

Tuchklemmen

Towel clamps

Fissateli

Pinzas de campo

Pinces pour fixer les
compresses

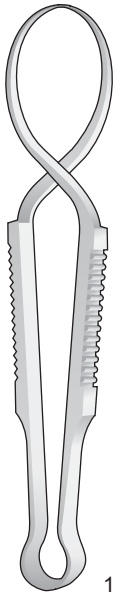

1/1

SCHAEDEL
BF-38
85 mm

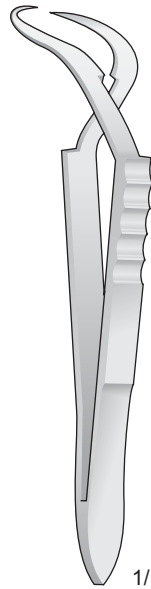

1/1

JONES
BF-48
90 mm

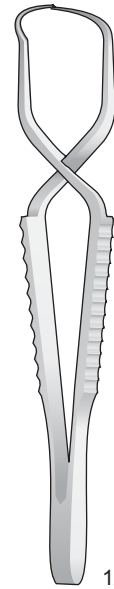

1/1

FAURE
BF-40
85 mm

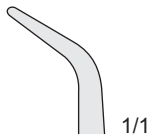

1/1

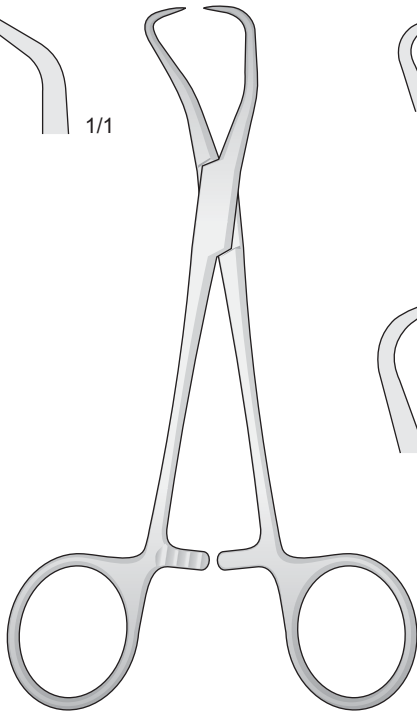

BACKHAUS
BF-41/BF-46

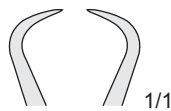

1/1

BF-42
90 mm

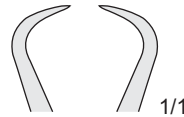

1/1

BF-41
100 mm

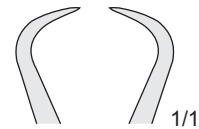

1/1

BF-44
110 mm

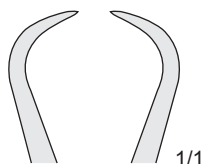

1/1

BF-46
130 mm

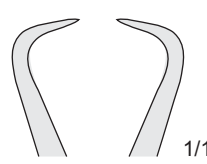

1/1

BF-43
135 mm

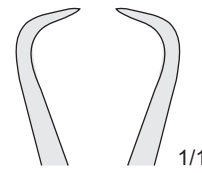

1/1

BF-45
140 mm

Tuchklemmen

Towel clamps

Fissateli

Pinzas de campo

Pinces pour fixer les compresses

Für Papiertücher
For paper cloths
Per teli di carta
Para paños
Pour Champs en papier

Für Papiertücher
For paper cloths
Per teli di carta
Para paños
Pour Champs en papier

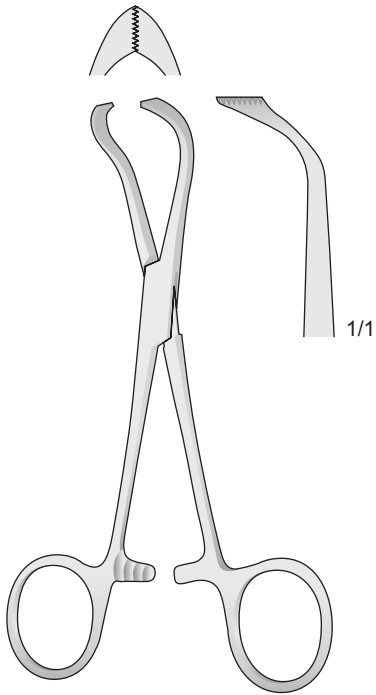

LORNA
BF-50
100 mm

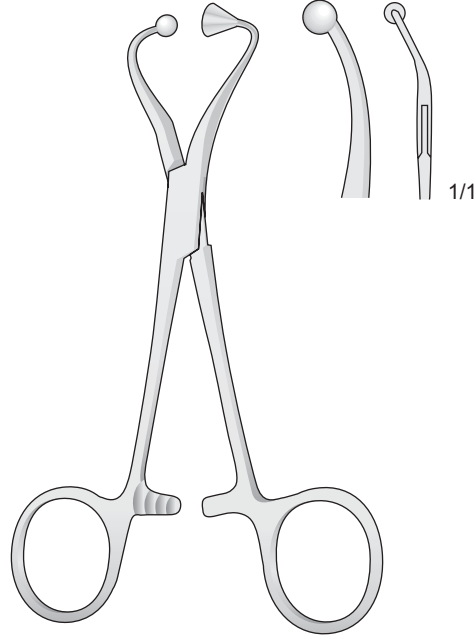

BF-74
115 mm

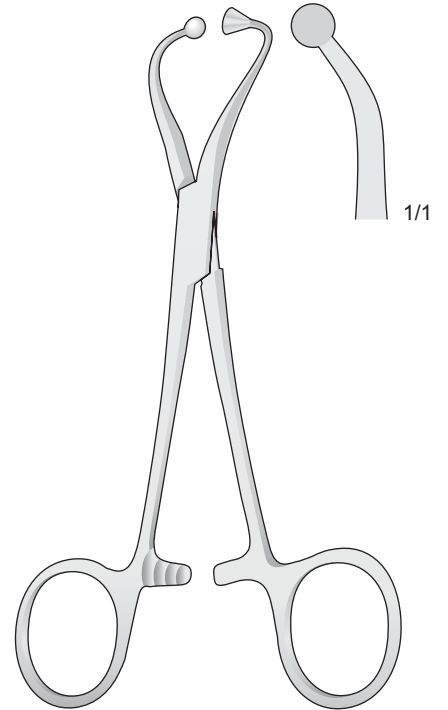

BF-75
140 mm

Für Papiertücher - For paper cloths
Per teli di carta - Para paños
Pour Champs en papier

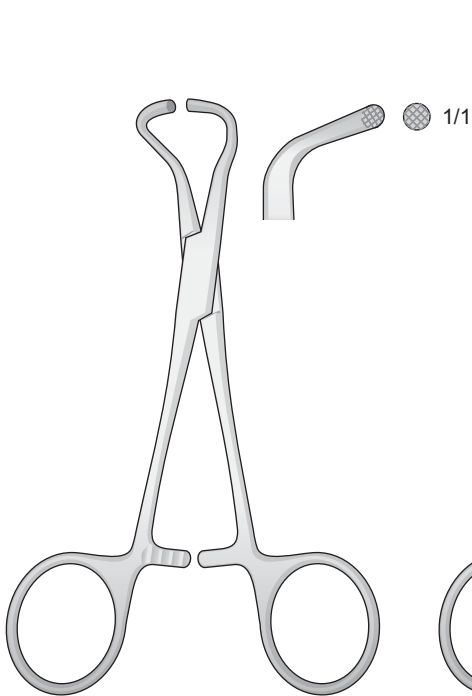

BF-76
100 mm

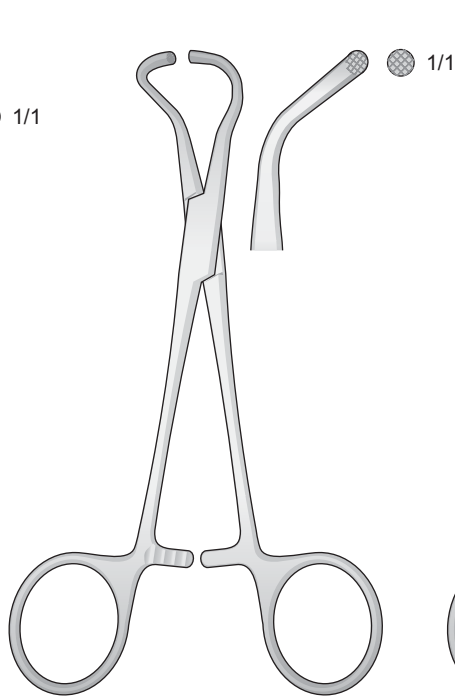

BF-77
125 mm

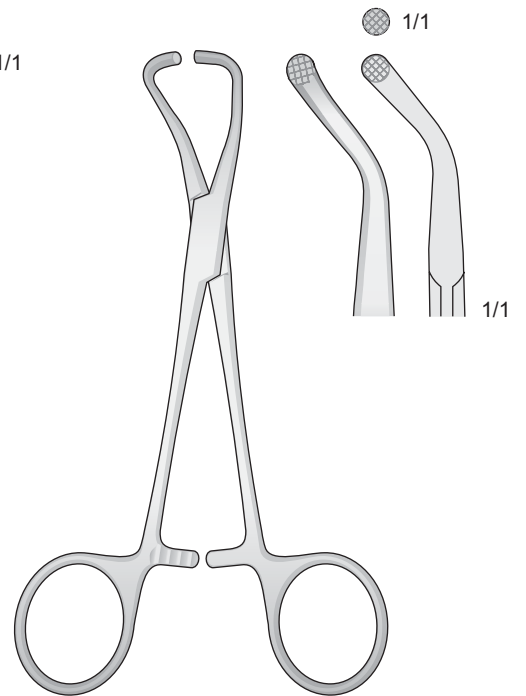

BF-52
130 mm

Arterienklemmen

Hemostatic forceps

Pinze emostatiche

Pinces hémostatiques

Pinces hémostatiques

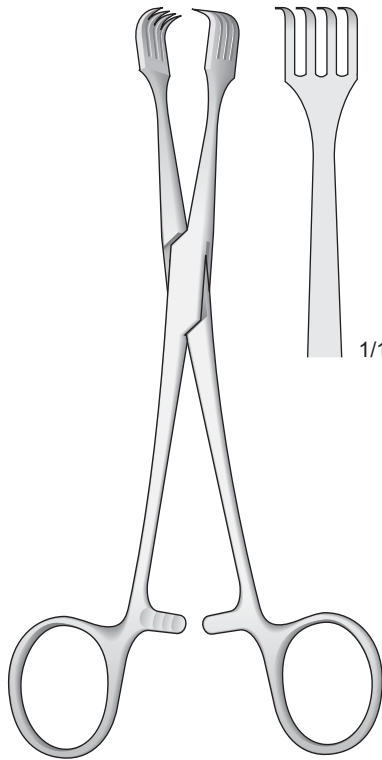

BRAUN
BF-58
155 mm

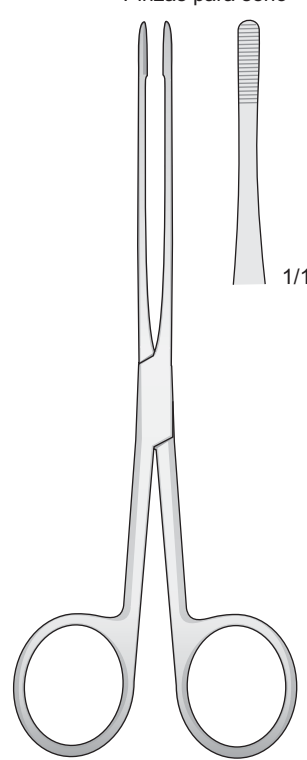

LISTER
BF-20
150 mm

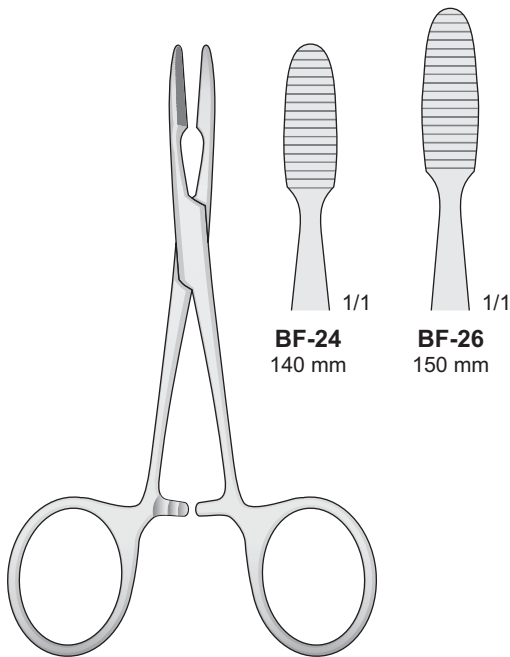

PEAN-MURPHY
BF-24/BF-26

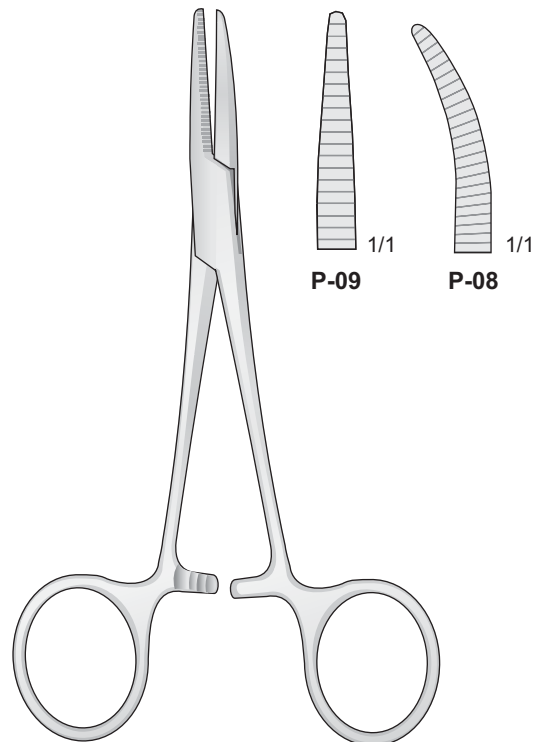

JONES
P-09/P-08
150 mm

Schwamm und
Tamponzangen

Sponge and dressing
forceps

Pinze per tamponi

Pinces à tampons

Pinces à tampons

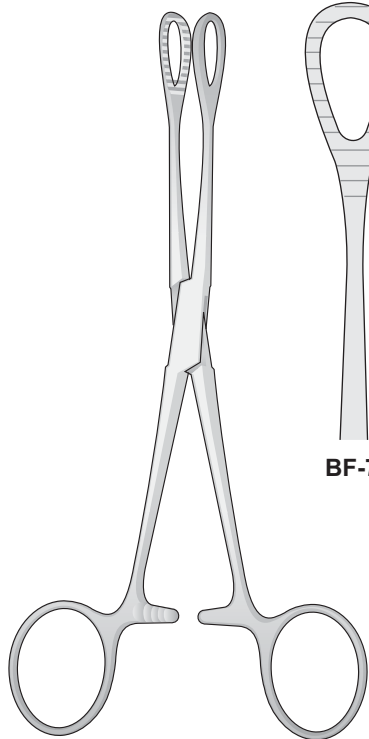

FOERSTER-BALLENGER
BF-78/BF-79
180 mm

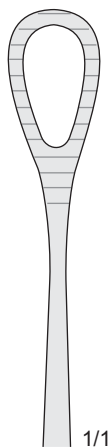

BF-78



BF-79

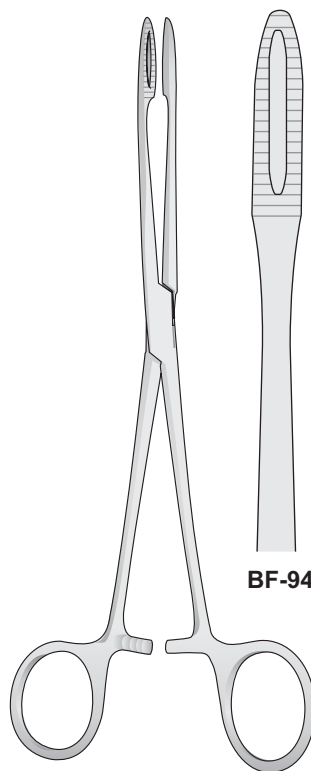

GROSS
BF-94/BF-95
200 mm

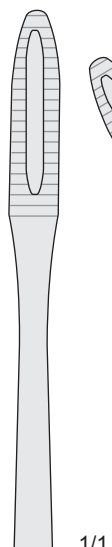

BF-94



BF-95

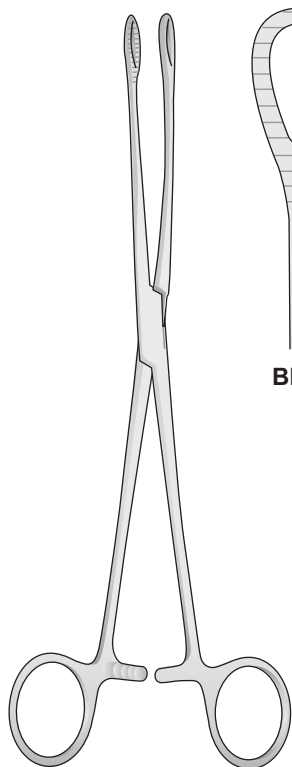

FOERSTER-BALLENGER
BF-11/BF-13
240 mm

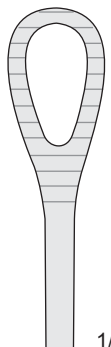

BF-11



BF-13

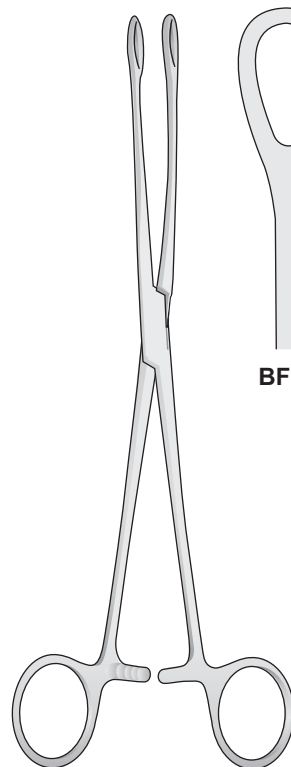

FOERSTER-BALLENGER
BF-14/BF-15
240 mm

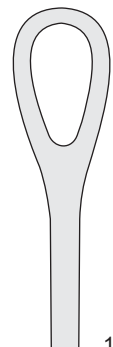

BF-14



BF-15

Schwamm und
Tamponzangen

Sponge and dressing
forceps

Pinze per tamponi

Pinces à tampons

Pinces à tampons

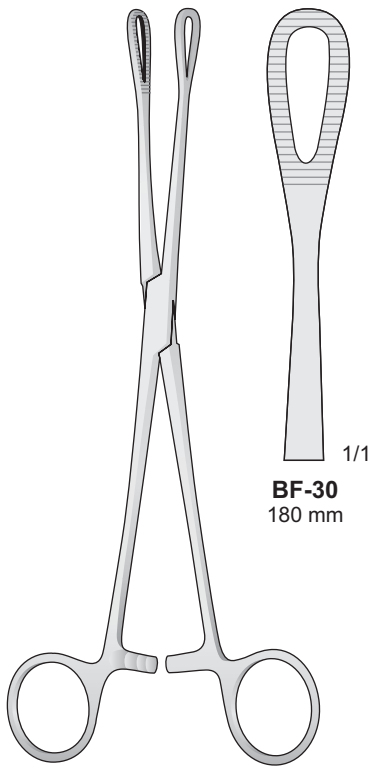

BF-30
180 mm

RAMPLEY
BF-30/BF-31

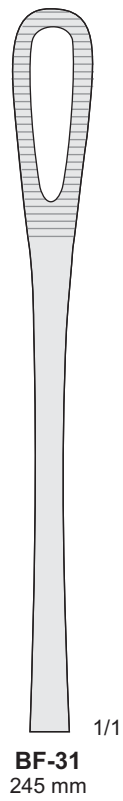

BF-31
245 mm

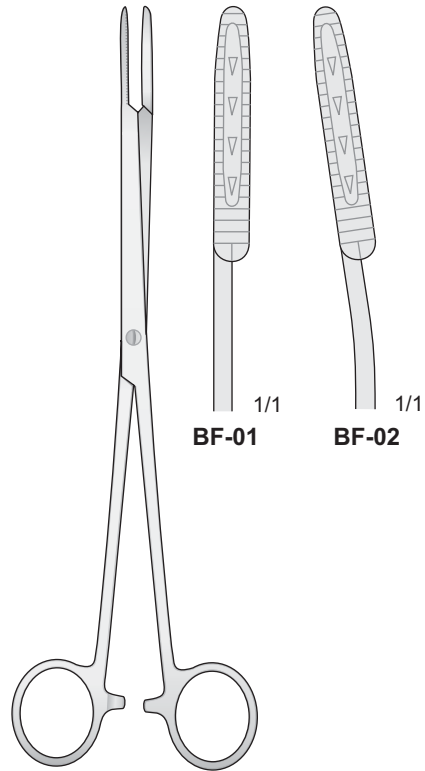

BF-01

BF-02

MAIER
BF-01/BF-02
245 mm

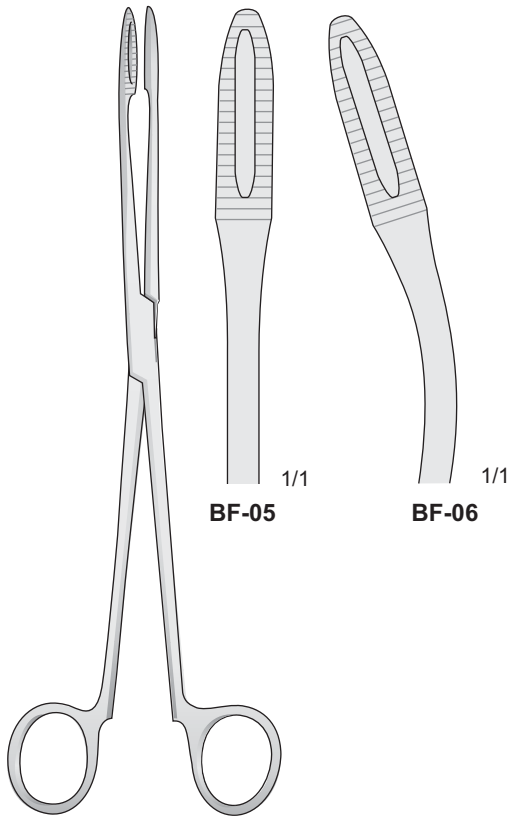

BF-05

BF-06

MAIER
BF-05/BF-06
265 mm

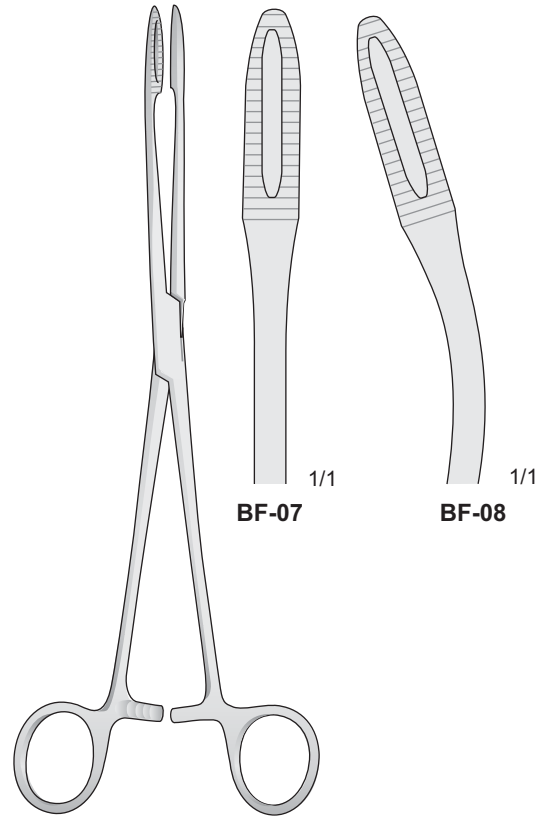

BF-07

BF-08

MAIER
BF-07/BF-08
265 mm

Fine-Arterienklemmen

Fine
Artery forceps

Pinze emostatiche
delicate

Pinzas hemostáticas
fino

Delicate
Pincas hémostáticas

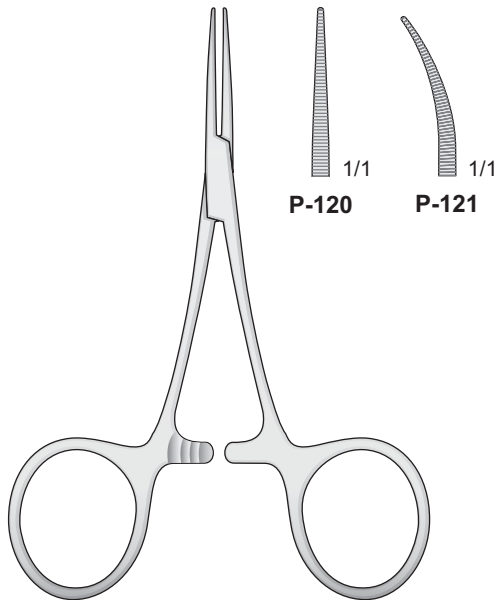

HARTMANN-BABY-MOSQUITO
P-120/P-121
95 mm

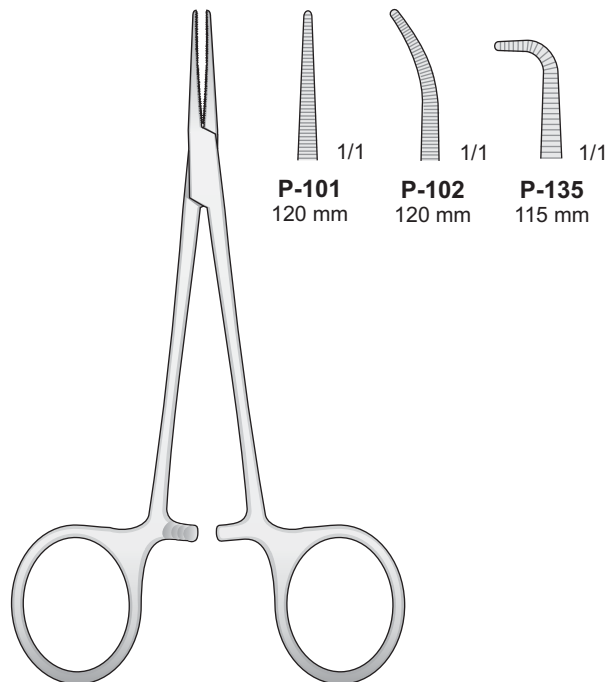

MICRO-HALSTED
P-101/P-135

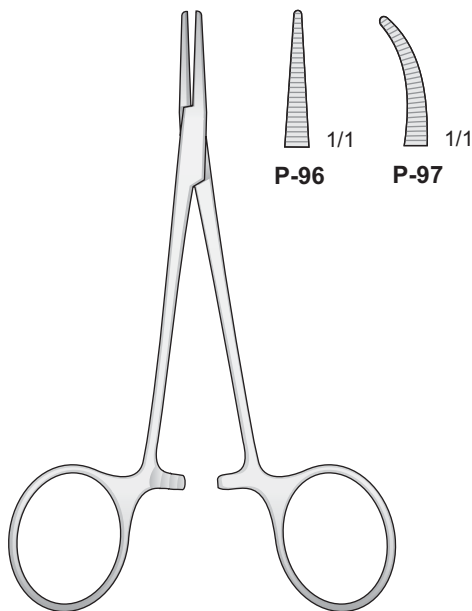

HALSTED-MOSQUITO
P-96/P-97
120 mm

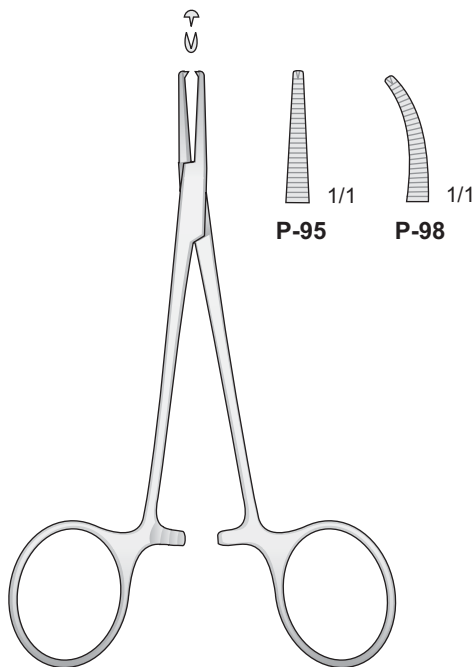

HALSTED-MOSQUITO
P-95/P-98
120 mm

Fine-Arterienklemmen

Fine
Artery forceps

Pinze emostatiche
delicate

Pinzas hemostáticas
fino

Delicate
Pincés hémostáticos

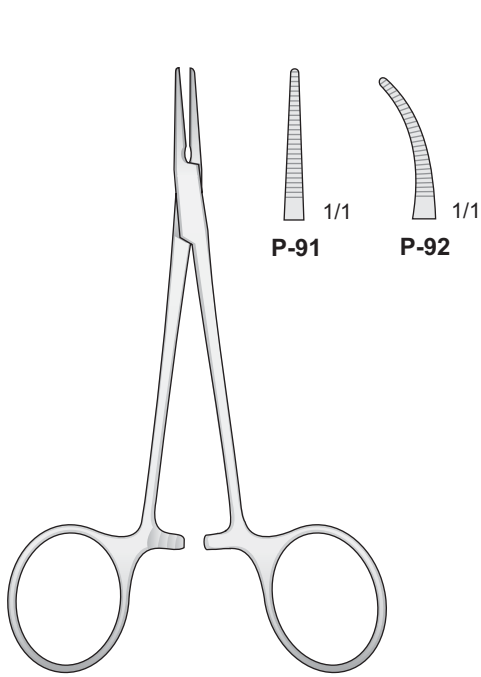

HALSTED
P-91/P-92
125 mm

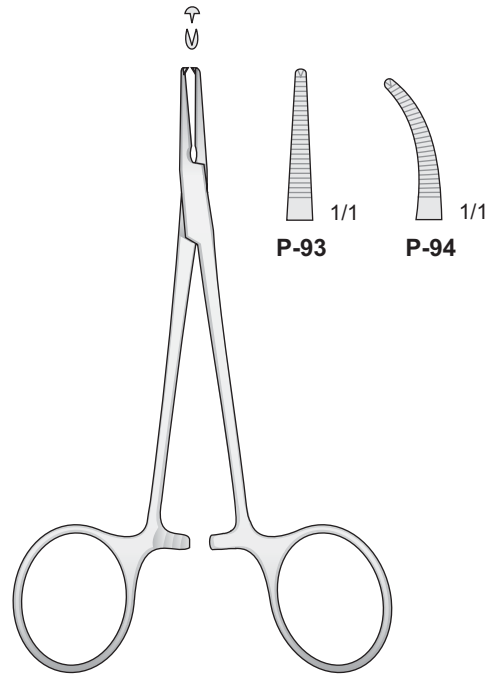

HALSTED
P-93/P-94
125 mm

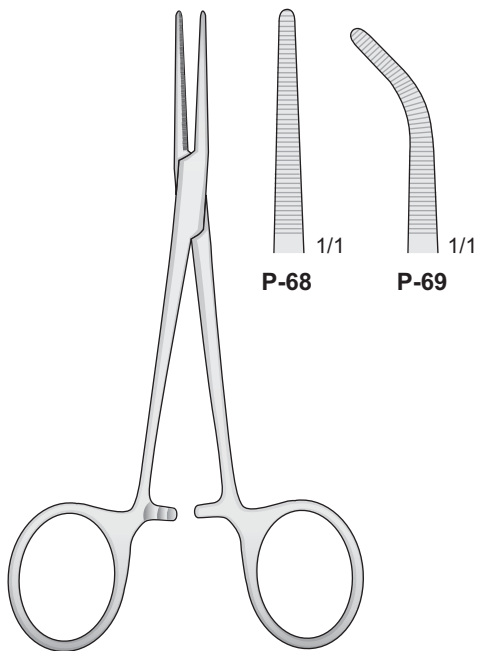

GIDEF
P-68/P-69
140 mm

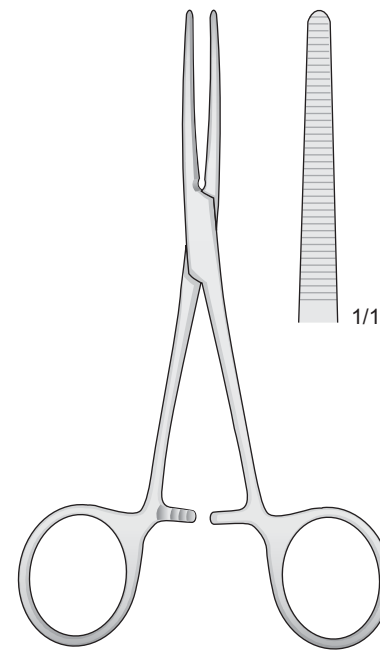

PEAN
P-17
140 mm

Arterienklemmen

Hemostatic forceps

Pinze emostatiche

Pinzas hemostáticas

Pinces hémostatiques

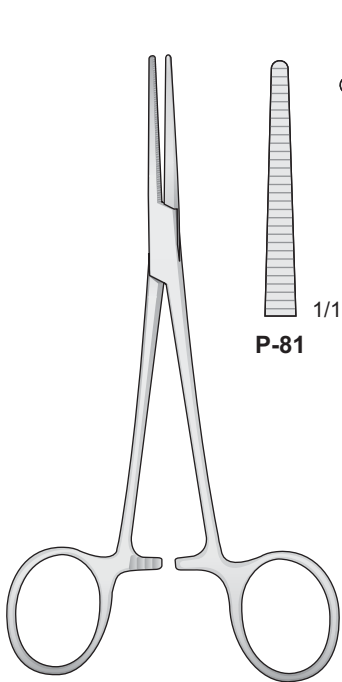

CRILE
P-81/P-82
140 mm

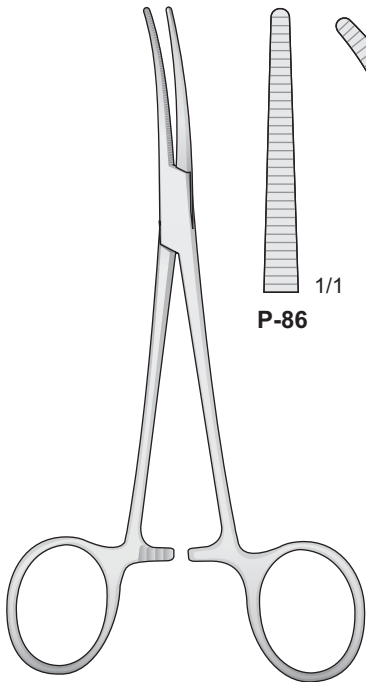

CRILE
P-86/P-87
160 mm

Seitwärts gebogen
Curved to side
Curve sul lato
Curvas laterales
Courbes latérales

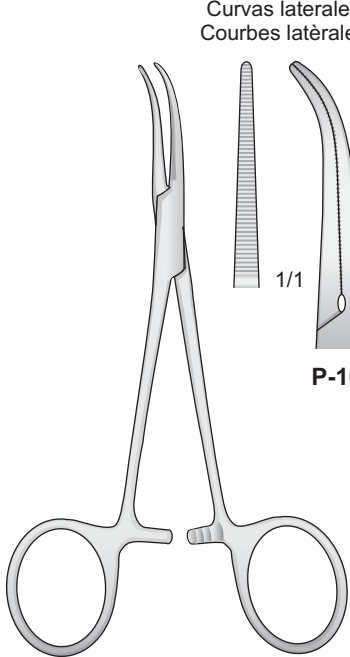

DANDY
P-16/P-122
140 mm

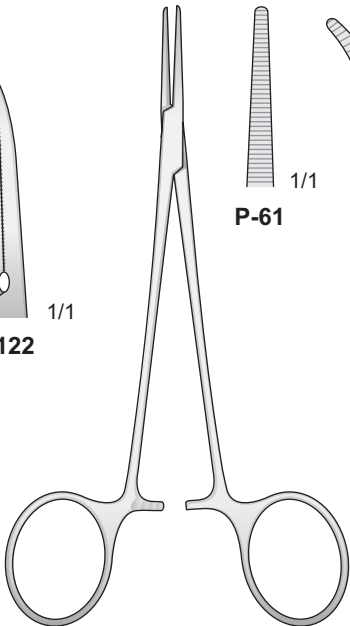
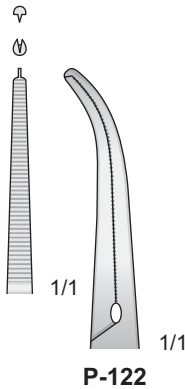

LERICHE
P-61/P-62
150 mm

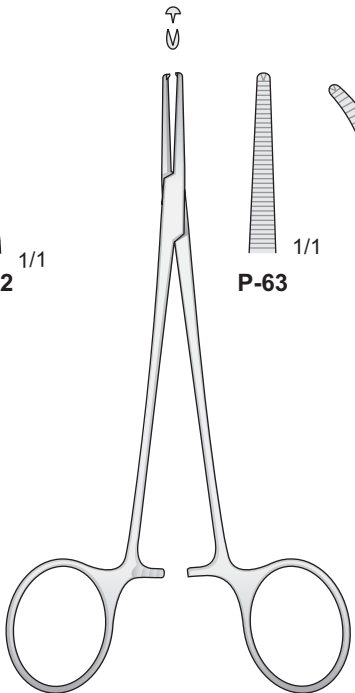
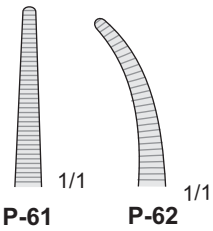

LERICHE
P-63/P-64
150 mm

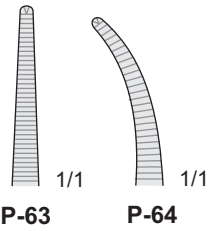

Arterienklemmen

Hemostatic forceps

Pinze emostatiche

Pinzas hemostáticas

Pinces hémostatiques

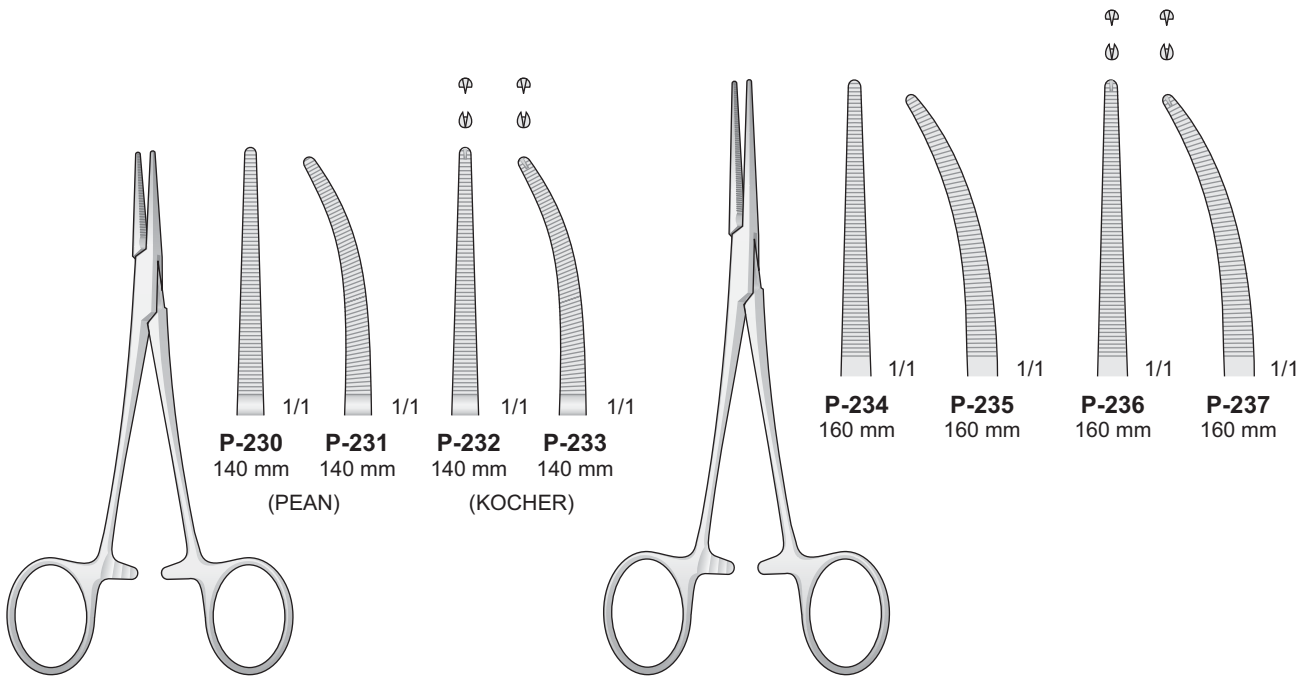

BABY-CRILE
P-230/P-233
140 mm

CRILE
P-234/P-237
160 mm

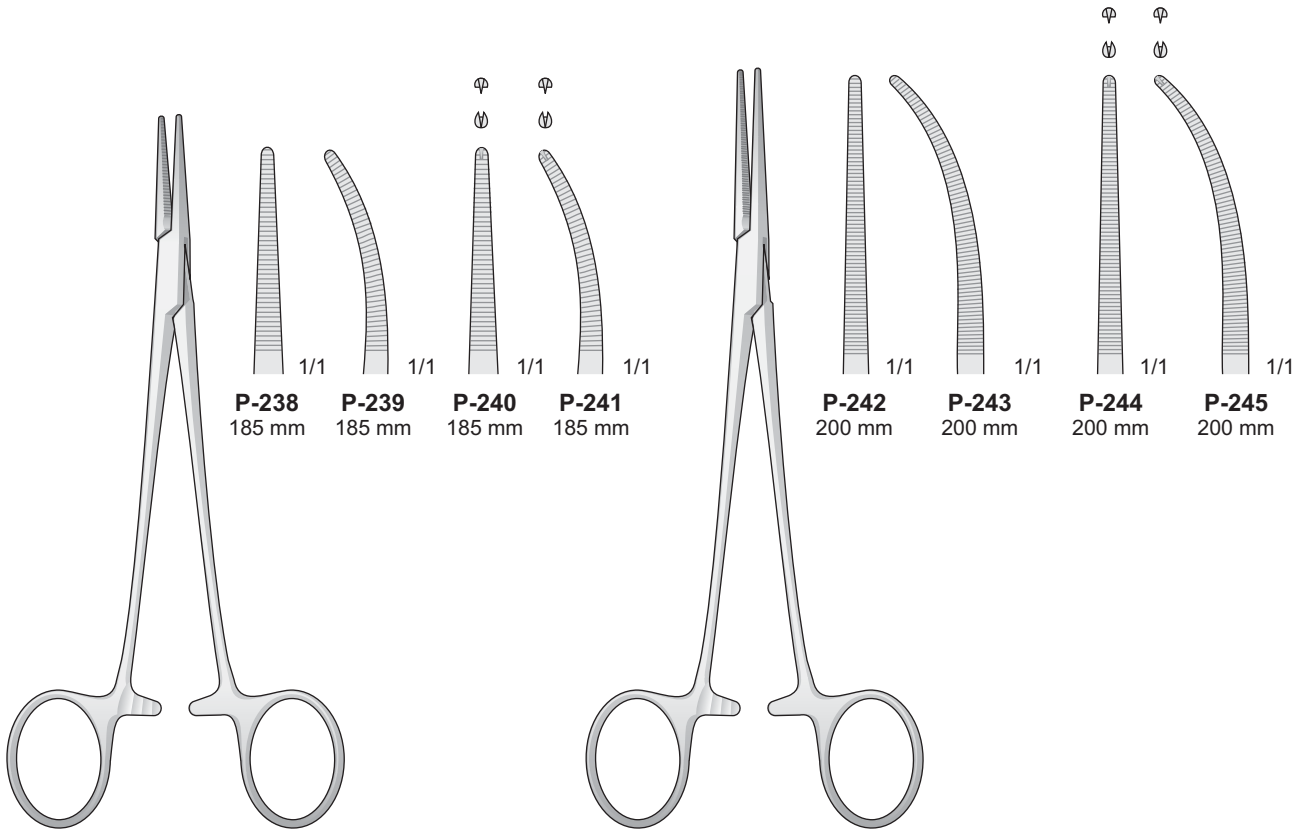

HALSTED
P-238/P-241
185 mm

HALSTED-MOSQUITO
P-242/P-245
200 mm

Arterienklemmen

Hemostatic forceps

Pinze emostatiche

Pinzas hemostáticas

Pinces hémostatiques

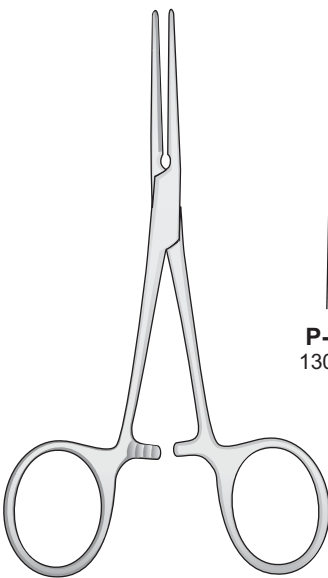

PEAN
P-250/P-255

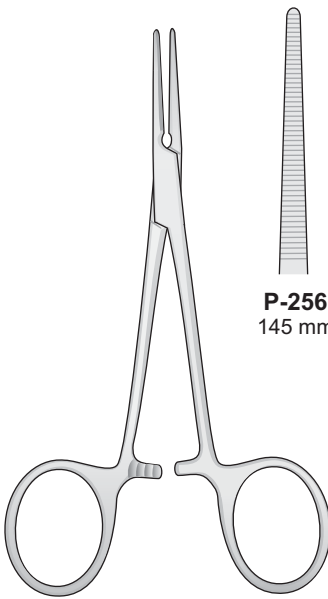
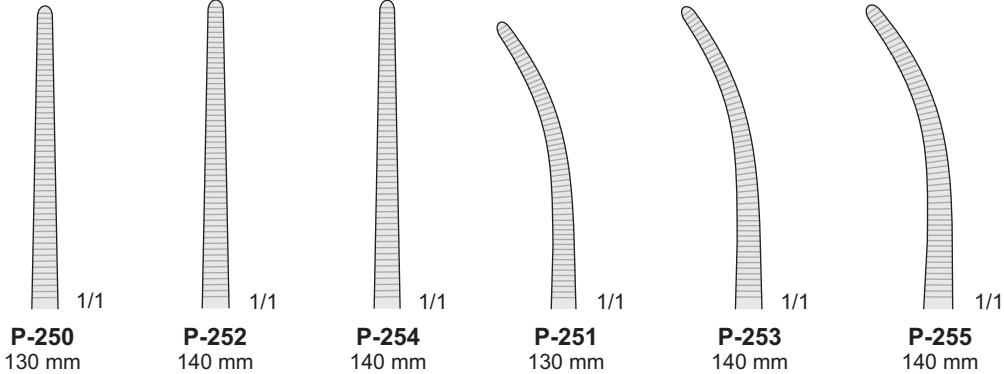

PEAN
P-256/P-259

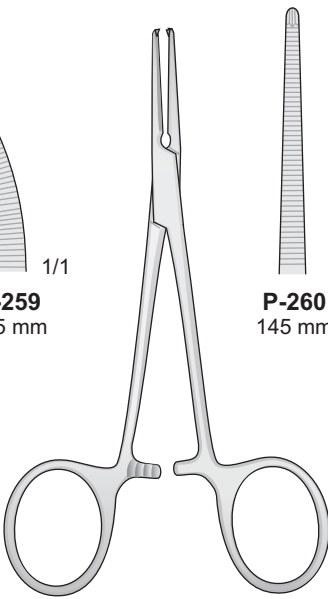
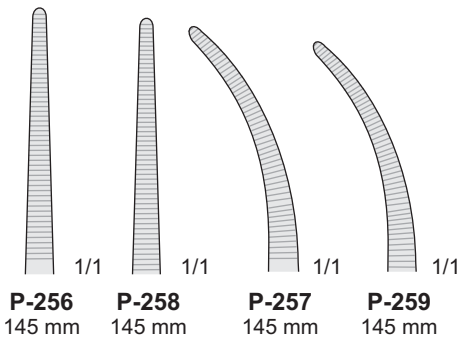

KOCHER
P-260/P-263

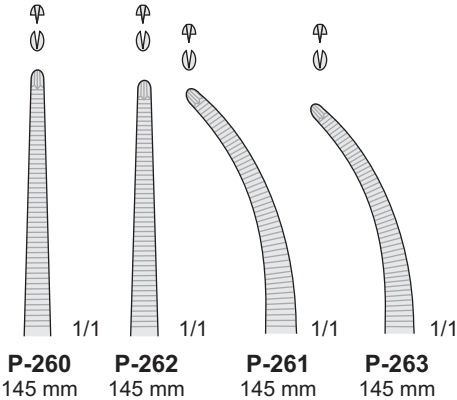

Arterienklemmen

Hemostatic forceps

Pinze emostatiche

Pinzas hemostáticas

Pinces hémostatiques

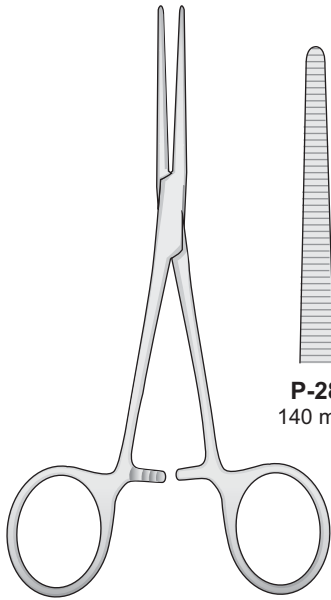

ROCHESTER-PEAN
P-18/P-29

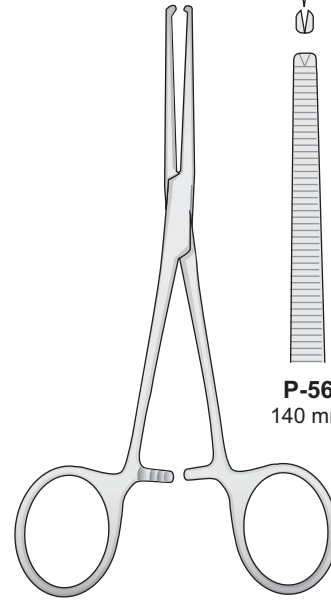
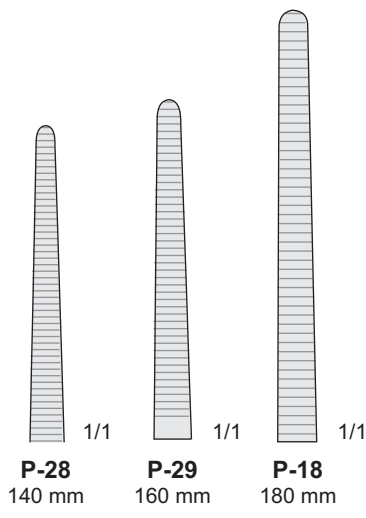

KOCHER-OCHSNER
P-56/P-221

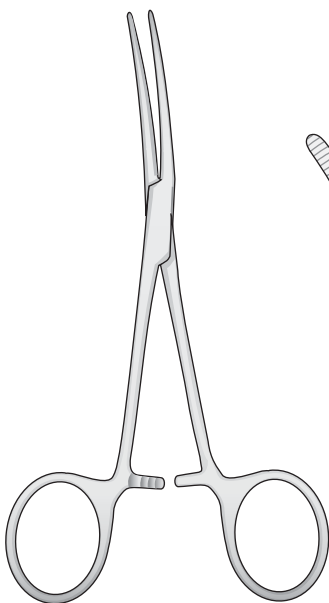
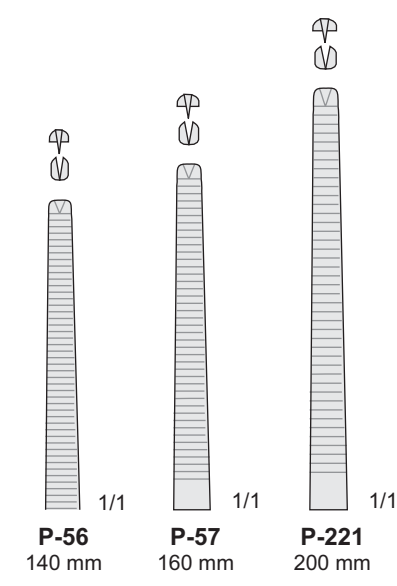

ROCHESTER-PEAN
P-19/P-39

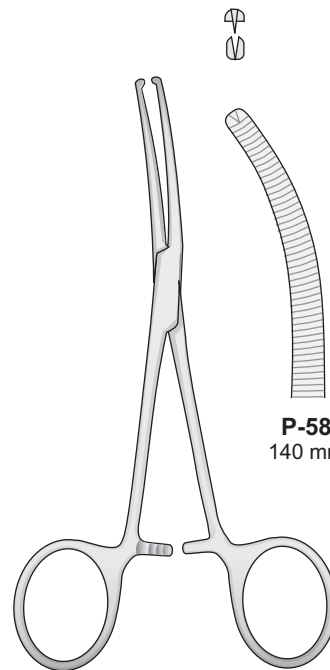
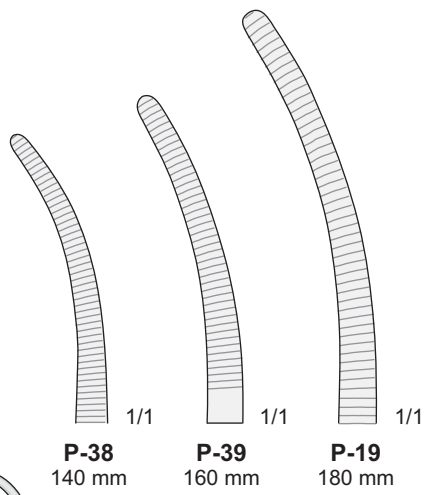

KOCHER-OCHSNER
P-58/P-59

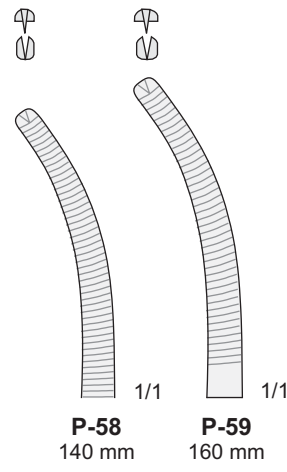

Arterienklemmen

Hemostatic forceps

Pinze emostatiche

Pinzas hemostáticas

Pinces hémostatiques

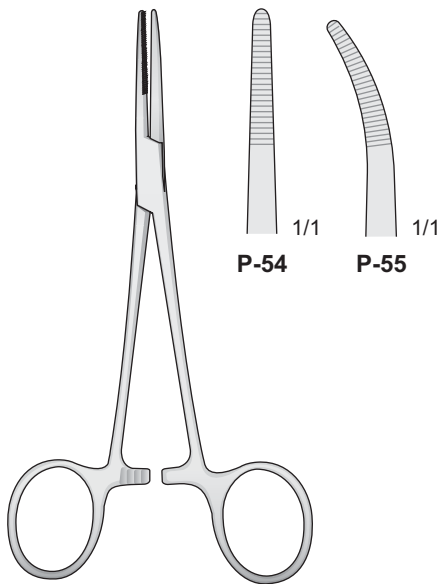

KELLY
P-54/P-55
140 mm

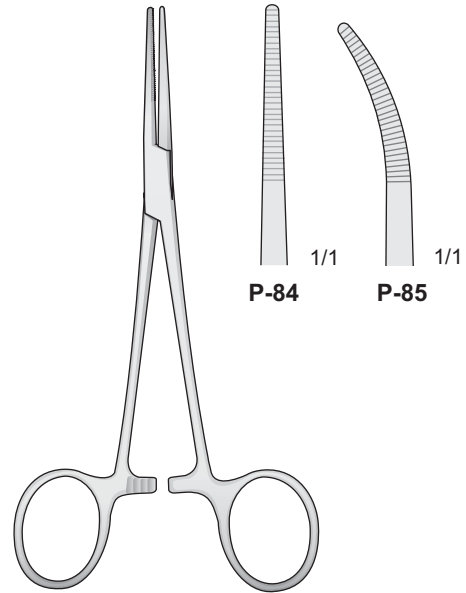

KELLY
P-84/P-85
140 mm

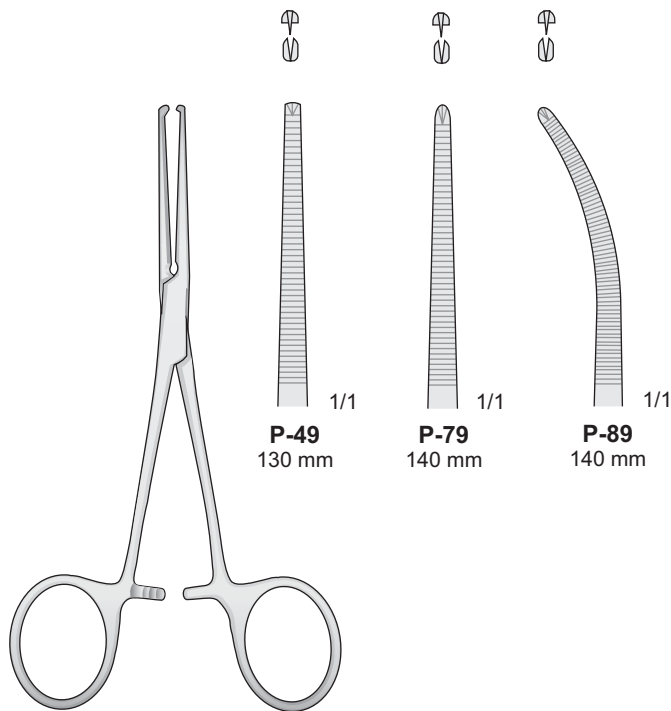

KOCHER
P-49/P-89

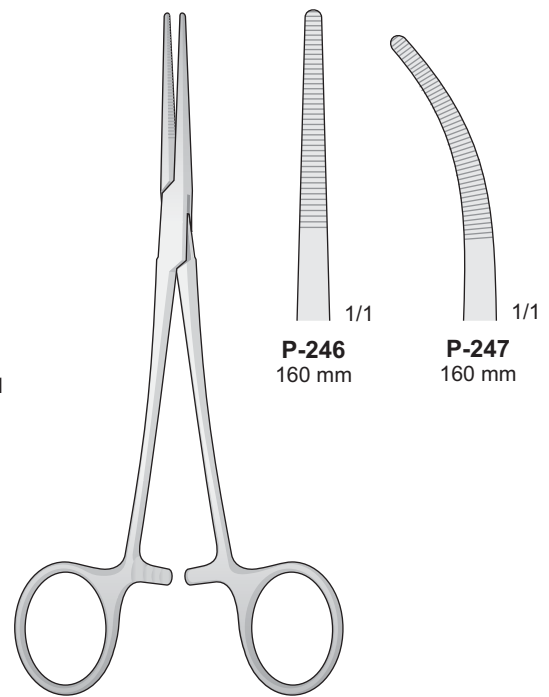

RANKIN
P-246/P-247

Arterienklemmen

Hemostatic forceps

Pinze emostatiche

Pinzas hemostáticas

Pinces hémostatiques

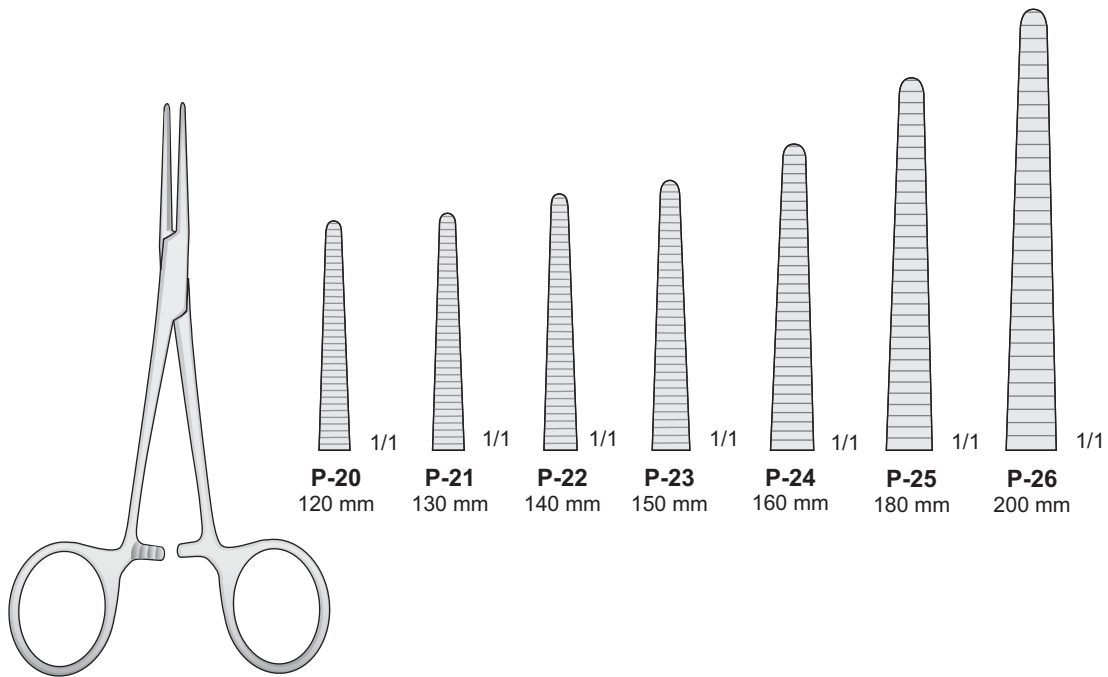

PEAN
P-20/P-26

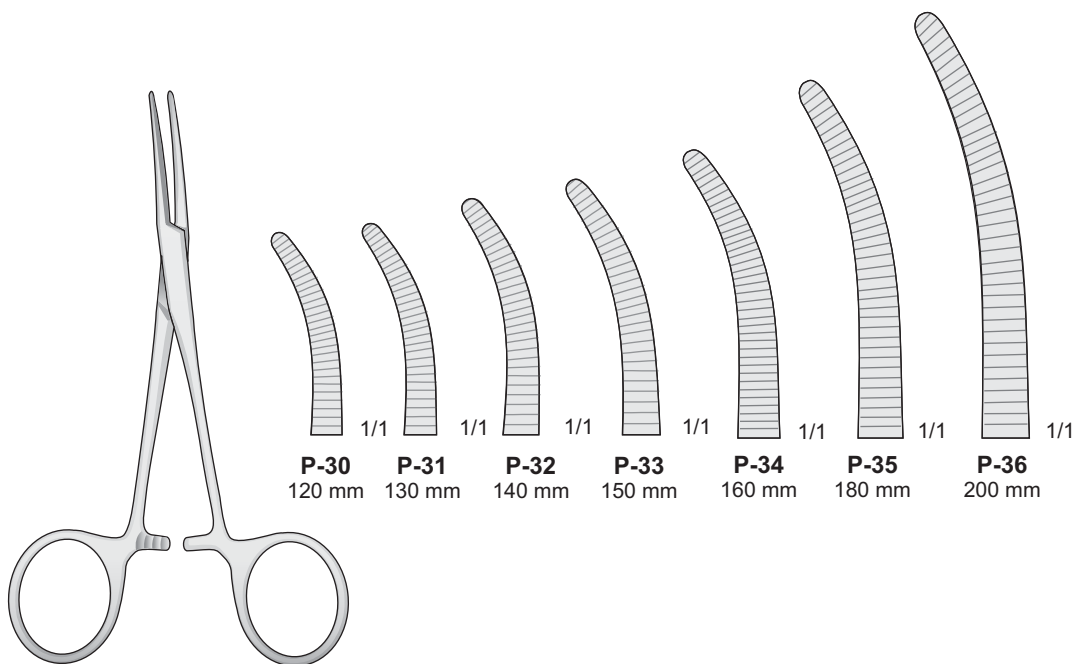

PEAN
P-30/P-36

Arterienklemmen

Hemostatic forceps

Pinze emostatiche

Pinzas hemostáticas

Pinces hémostatiques

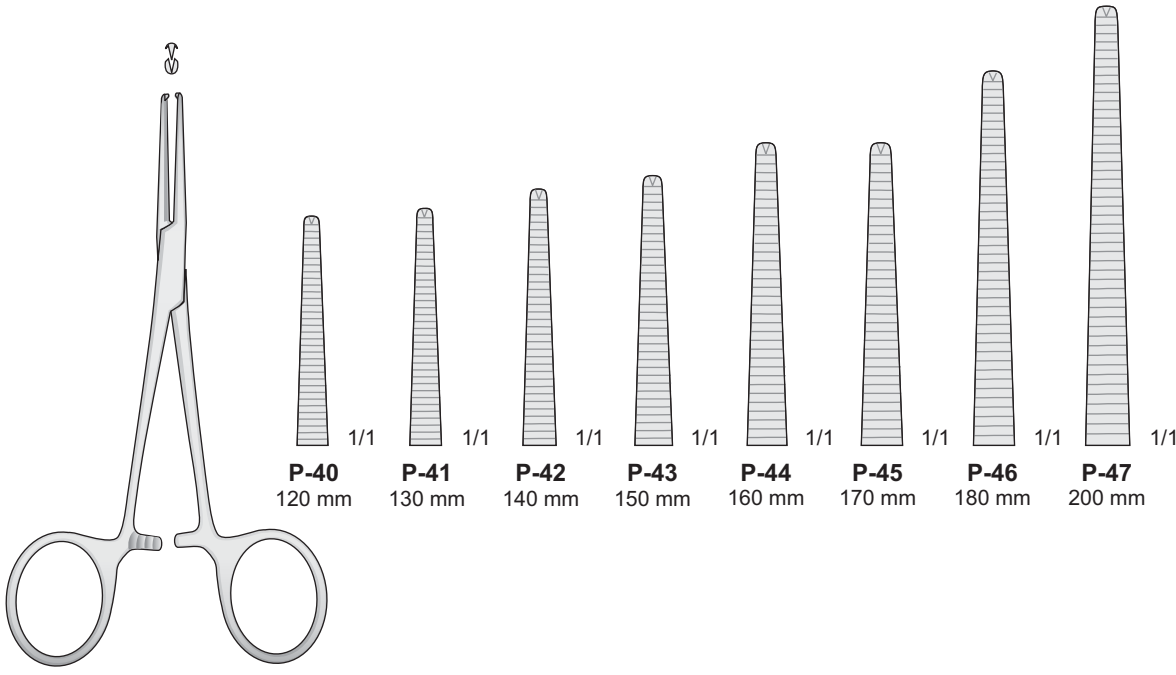

KOCHER
P-40/P-47

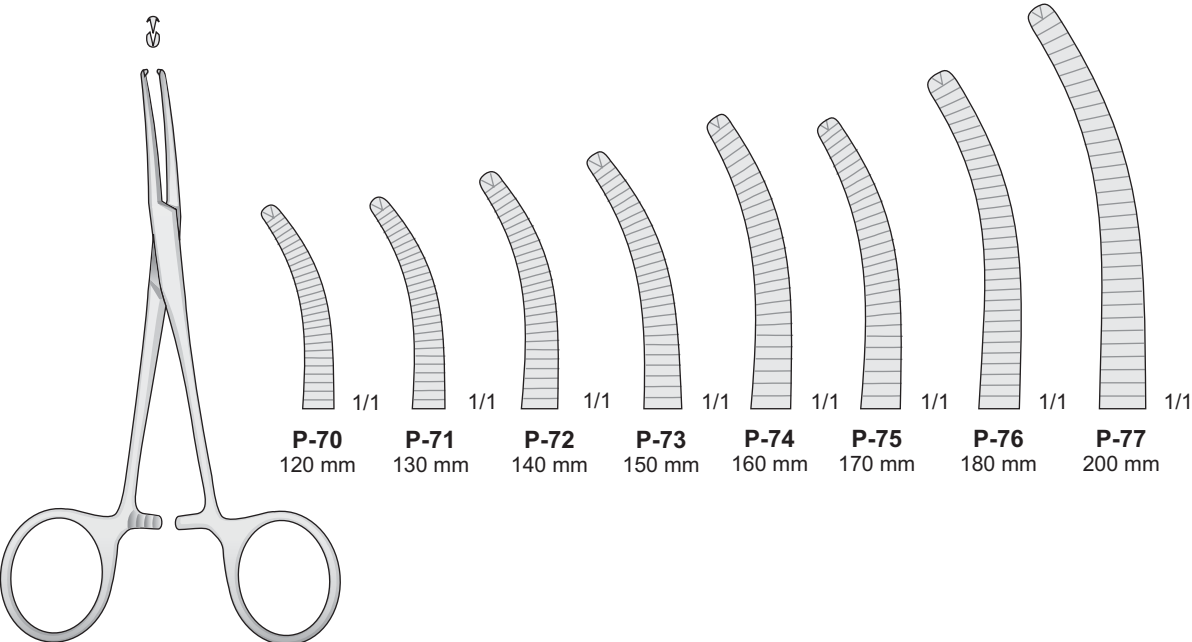

KOCHER
P-70/P-77

Arterienklemmen

Hemostatic forceps

Pinze emostatiche

Pinzas hemostáticas

Pinces hémostatiques

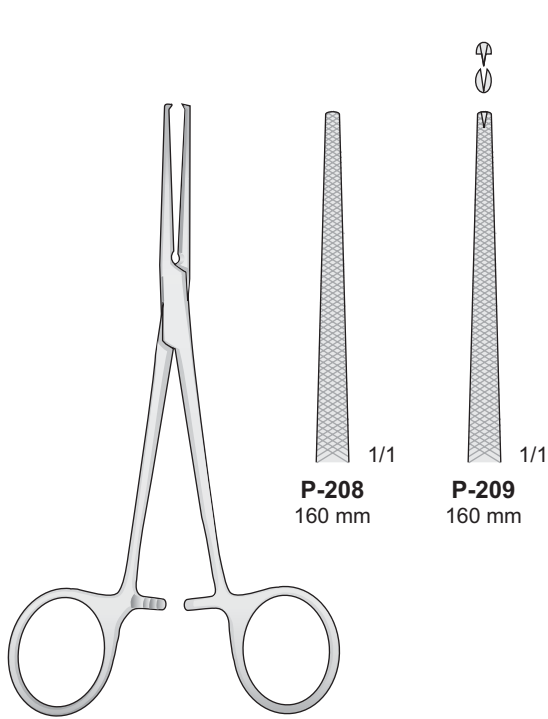

DIXON-LOVELACE
P-208/P-209

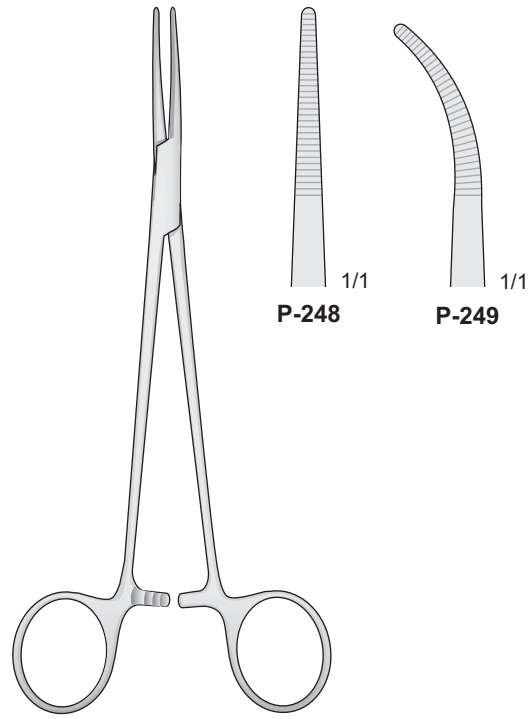

BIRKETT
P-248/P-249
180 mm

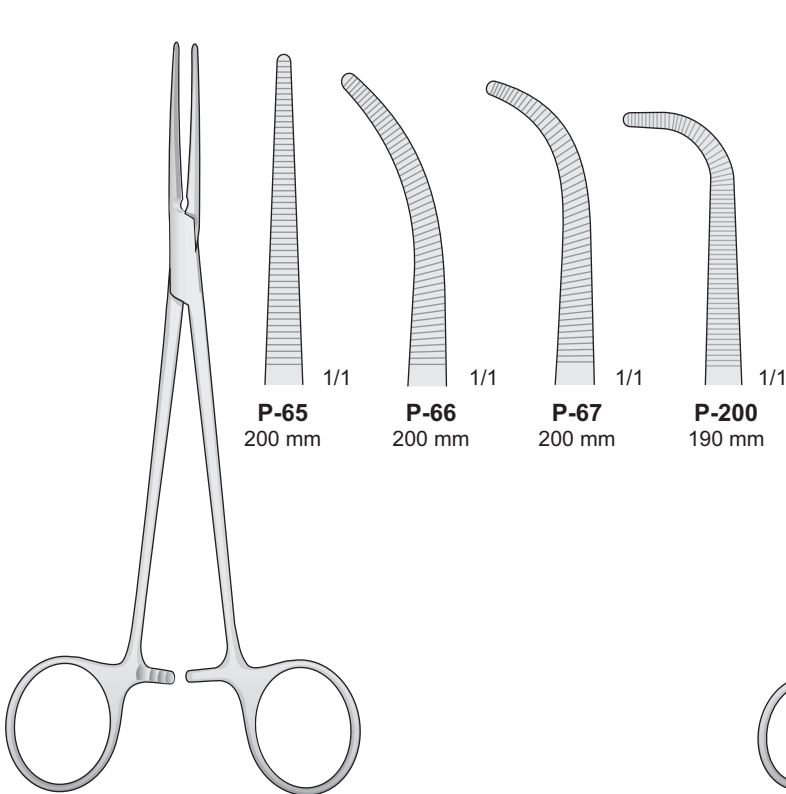

HEISS
P-65/P-200

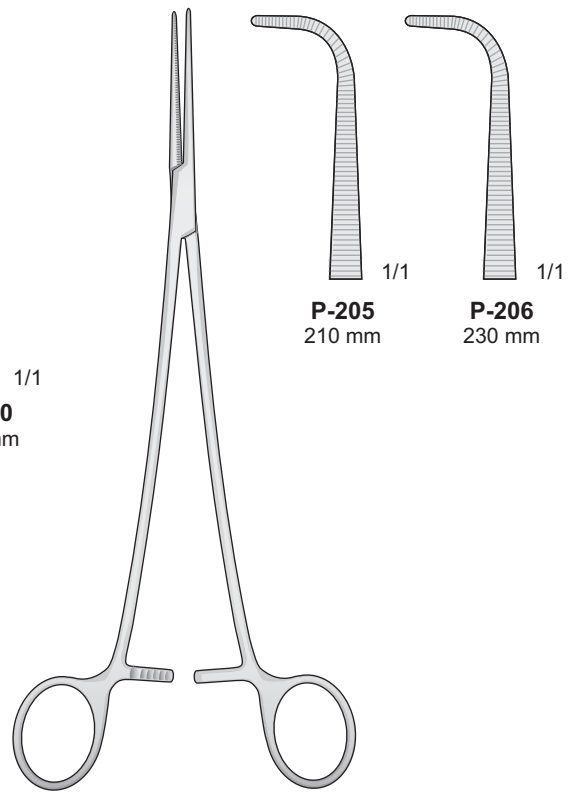

BENGOLEA
P-205/P-206

Arterienklemmen
Präparier und
Ligaturklemmen

Artery forceps
for preparation
and ligature

Pinze emostatiche
per preparazioni
e legature

Pinzas hemostáticas
Preparacion
y para ligaduras

Pinces hemostáticas
à disséquer
et à ligatures

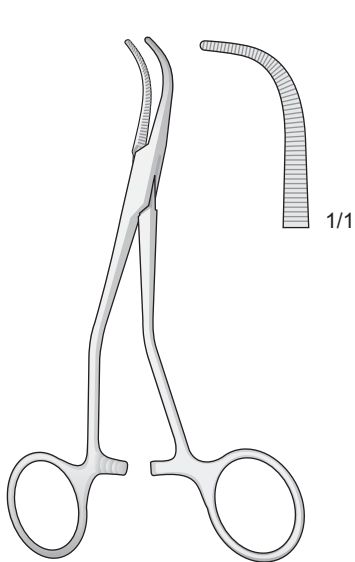

P-15
130 mm

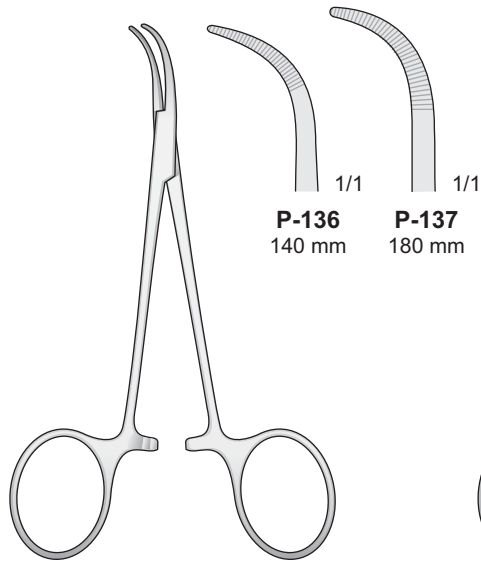

BABY-MIXTER
P-136/P-137

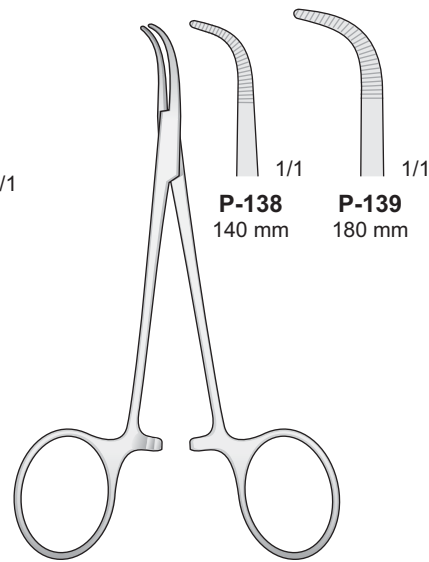

BABY-ADSON
P-138/P-139

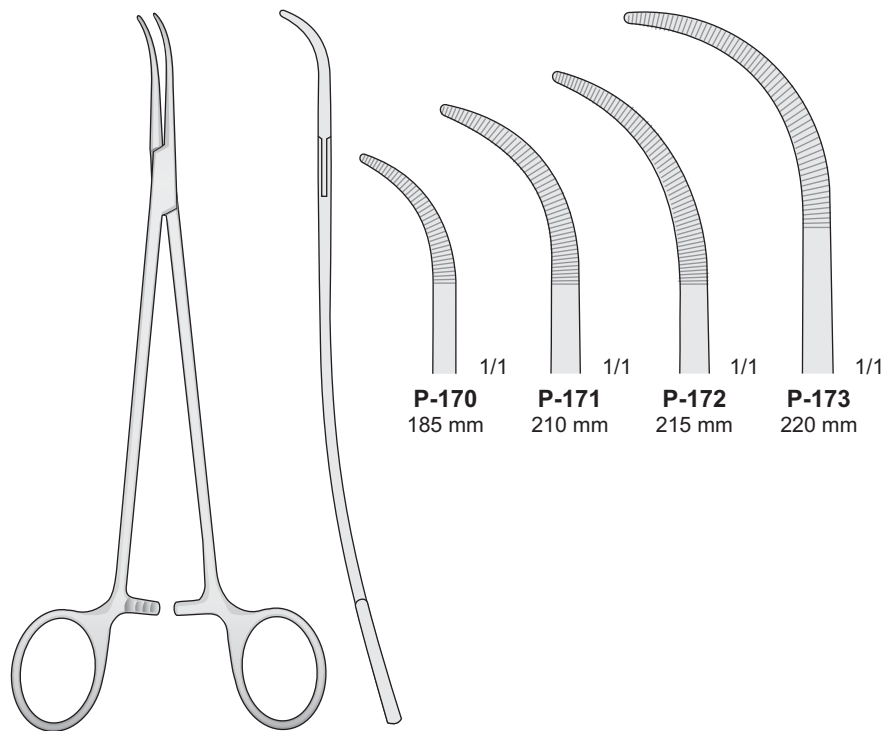

P-170/P-172

Arterienklemmen
Präparier und
Ligaturklemmen

Artery forceps
for preparation
and ligature

Pinze emostatiche
per preparazioni
e legature

Pinzas hemostáticas
Preparacion
y para ligaduras

Pinces hemostáticas
à disséquer
et à ligatures

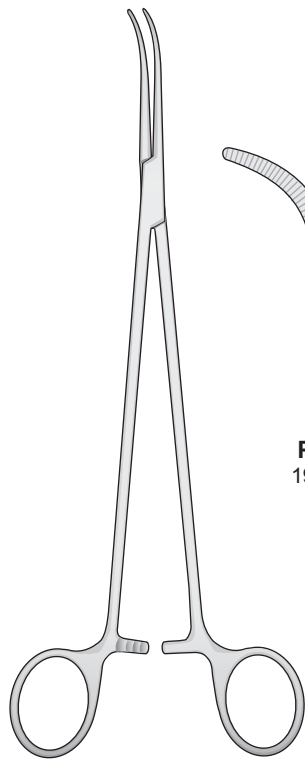

OVERHOLT-GEISSENDORFER
P-142/P-148

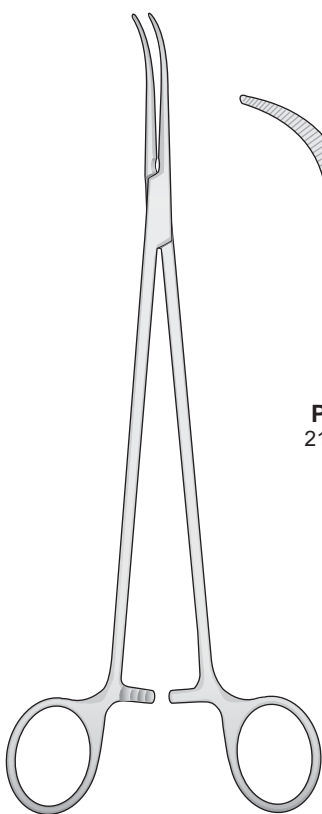
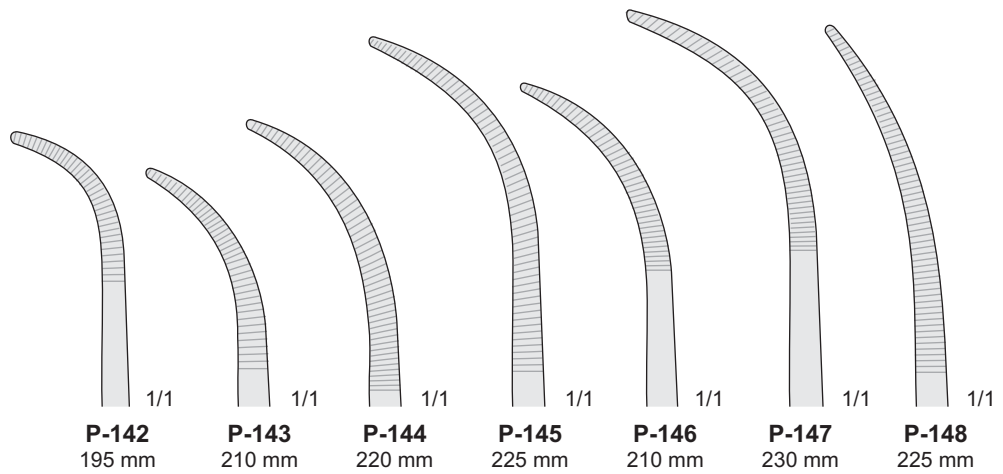

OVERHOLT
P-160/P-166

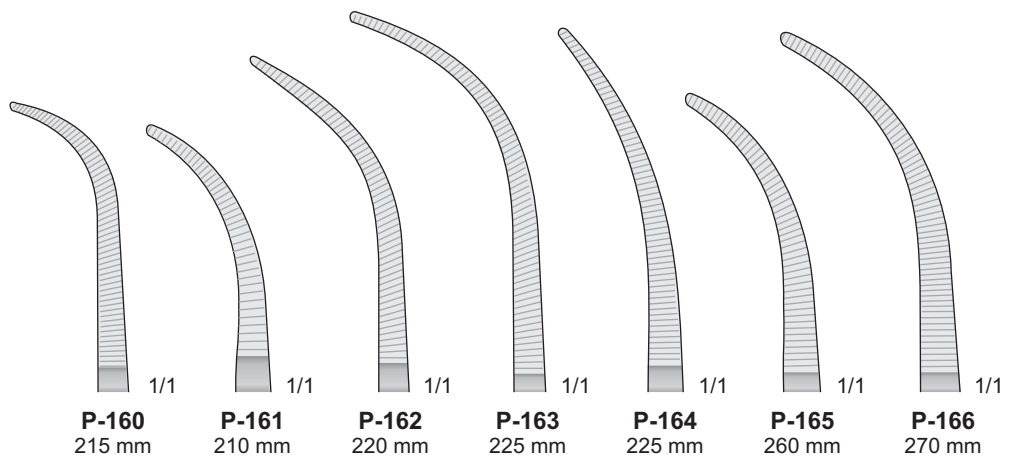

Arterienklemmen
Präparier und
Ligaturklemmen

Artery forceps
for preparation
and ligature

Pinze emostatiche
per preparazioni
e legature

Pinzas hemostáticas
Preparacion
y para ligaduras

Pinces hemostáticas
à disséquer
et à ligatures

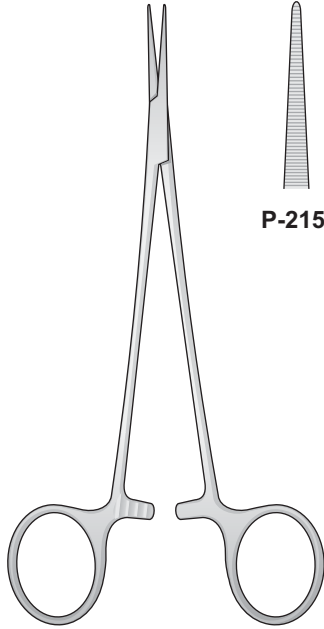

P-215/P-217
160 mm

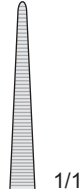

P-215

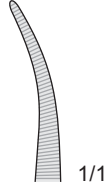

P-216

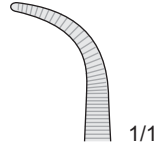

P-217

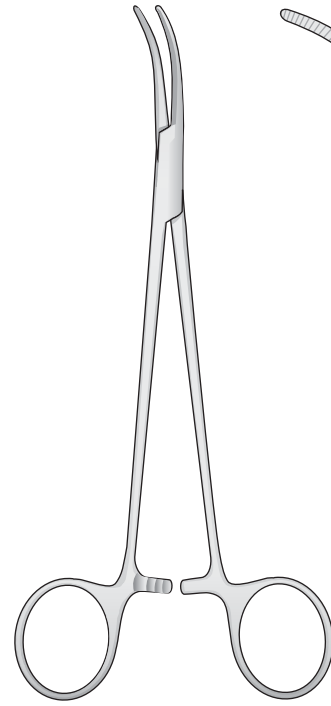

ROCHESTER-PEAN
P-210
180 mm

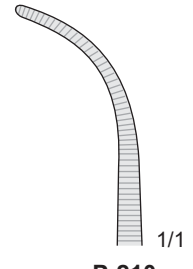

P-210

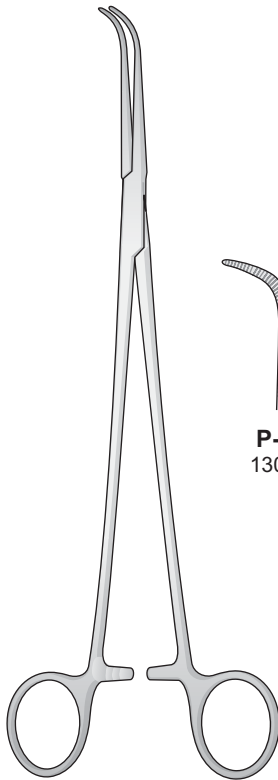

GEMINI
P-191/P-196

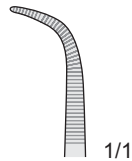

P-191
130 mm

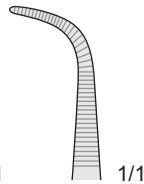

P-192
160 mm

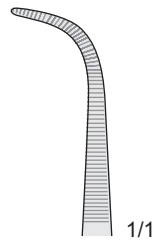

P-193
180 mm

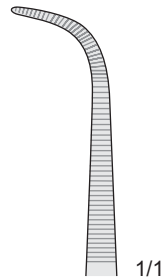

P-194
200 mm

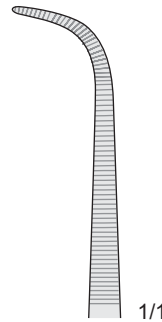

P-195
230 mm

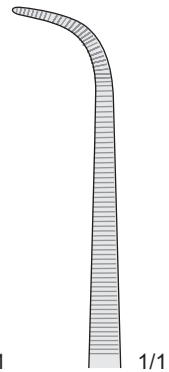

P-196
250 mm

**Isoliert - Insulated - Isolate - Aislante - Isolant
Monopolar - Monopolari**

mit sterilisierfähiger Kunststoff-Isolierbeschichtung - with autoclavable plastic coated insulated handles
con rivestimento isolante in plastica sterilizzabile - con recubrimiento aislante de materia plástica esterilizable
à enduit plastique isolant, stérilisable

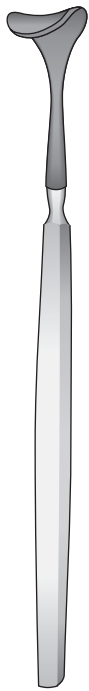

DESMARRES
BT-490/BT-493
140 mm

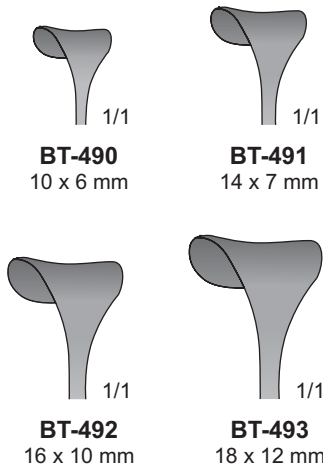

Anatomische Pinzetten, Chirurgische Pinzetten
Dressing Forceps, Tissue Forceps
Pinzette anatomiche e chirurgiche
Pinzas anatómicas, Pinzas quirúrgicas
Pincas anatomiques, Pincas chirurgicales

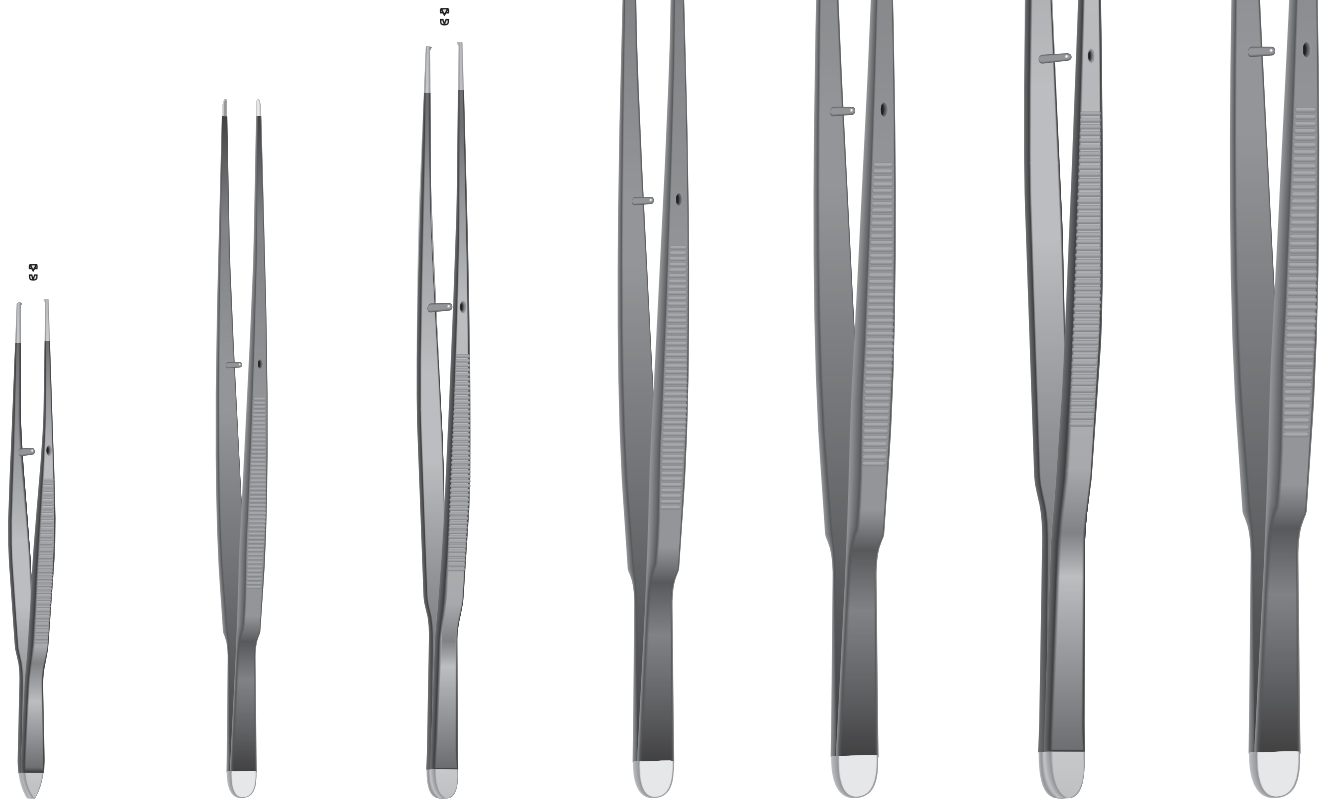

BD-194IS
100 mm

BD-10IS
145 mm

BD-273IS
155 mm

BD-20IS
200 mm

BD-23IS
230 mm

BD-277IS
250 mm

BD-24IS
250 mm

5

Nadelhalter
Needle holders
Port'aghi
Portaagujas
Porte aiguilles

Mikro Nadelhalter

Micro Needle Holders

Micro port'aghi

Micro portaagujas

Micro porte aiguilles

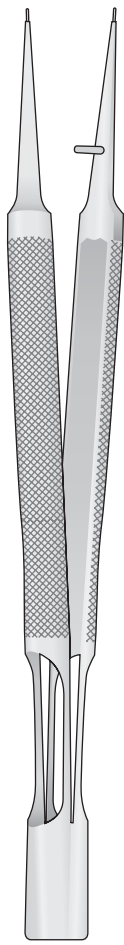
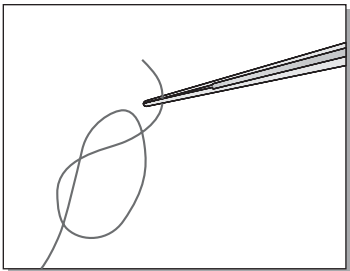

**BROCK
FD-203**
130 mm

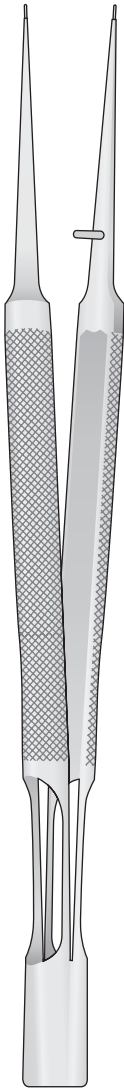
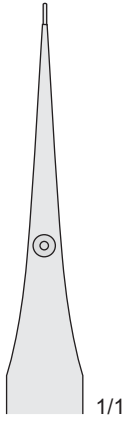

**BROCK
FD-204**
150 mm

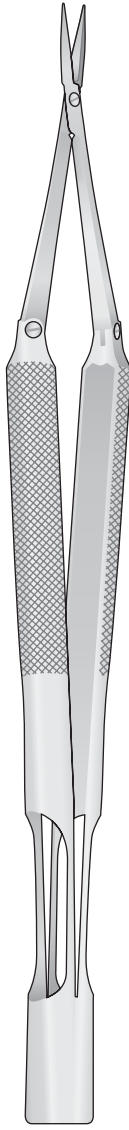
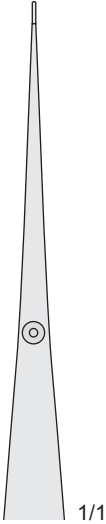

**BROCK
FD-211**
150 mm

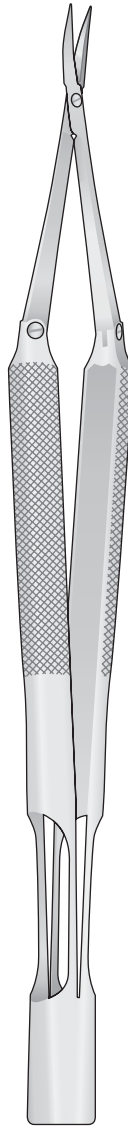
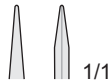

**BROCK
FD-213**
150 mm



Mikro Nadelhalter

Micro Needle Holders

Micro port'aghi

Micro portaagujas

Micro porte aiguilles

Glattes Maul
Smooth jaws
Con morso liscio
Mandibula lisa
A' mors lisses

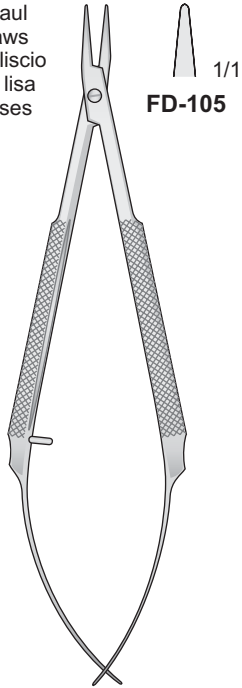

FD-105



FD-106

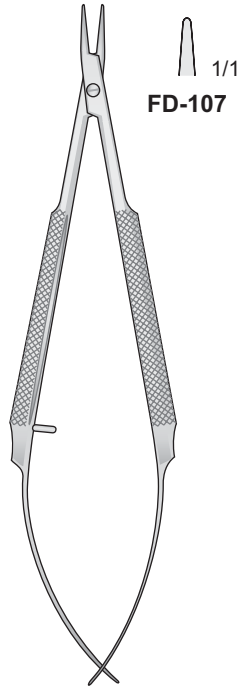

FD-107



FD-108

FD-105/FD-106
110 mm

FD-107/FD-108
110 mm

Glattes Maul
Smooth jaws
Con morso liscio
Mandibula lisa
A' mors lisses

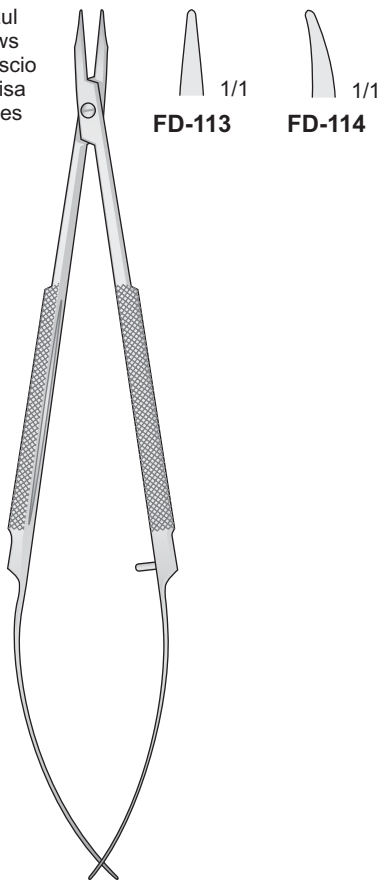

FD-113

FD-114

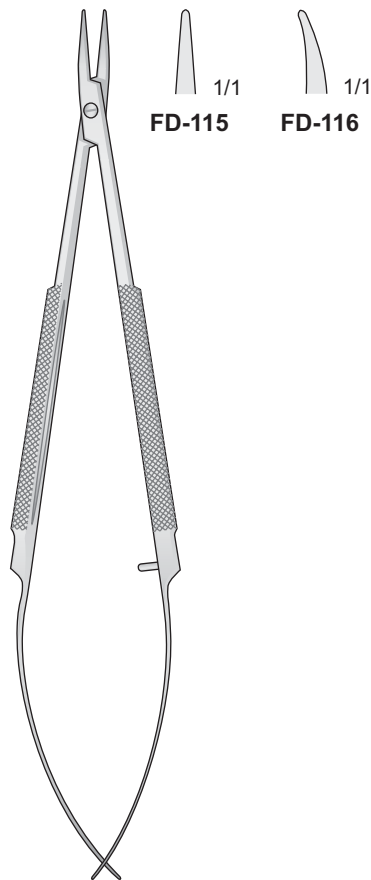

FD-115

FD-116

FD-113/FD-114
150 mm

FD-115/FD-116
150 mm

Feingerieftes Maul
Fine serrated jaws
Con morso zigrinato fine
Bocas estriadas finas
Mors stries fins

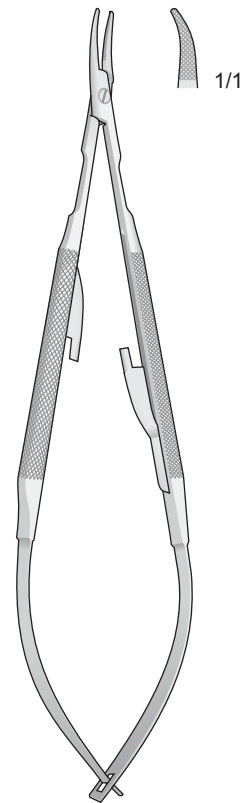

BARRAQUER
FD-24
135 mm

Glattes Maul - Smooth jaws
Con morso liscio - Mandibula lisa
A' mors lisses

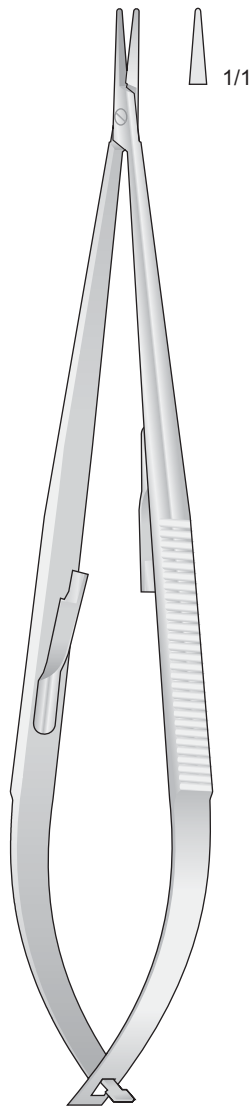

JACOBSON
FD-63
180 mm

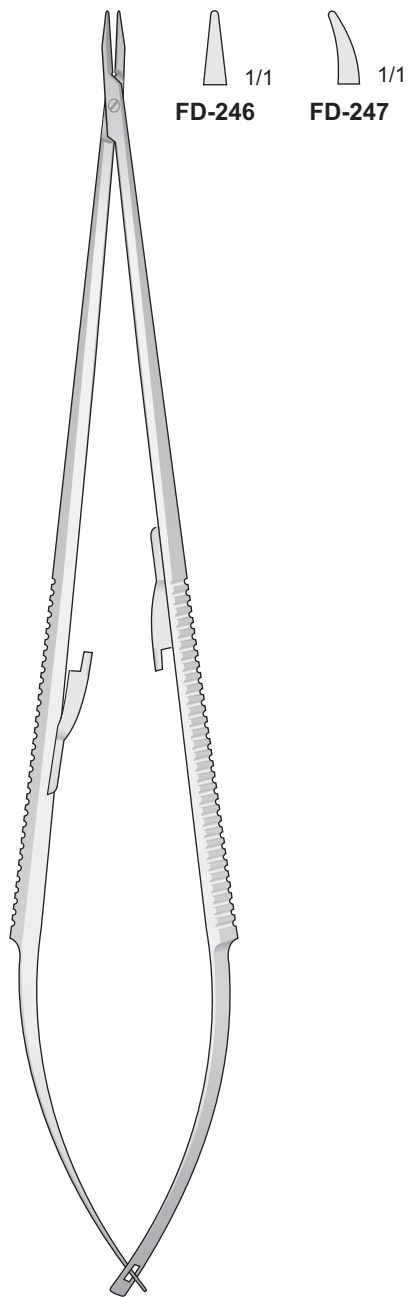

FD-246/FD-247
225 mm

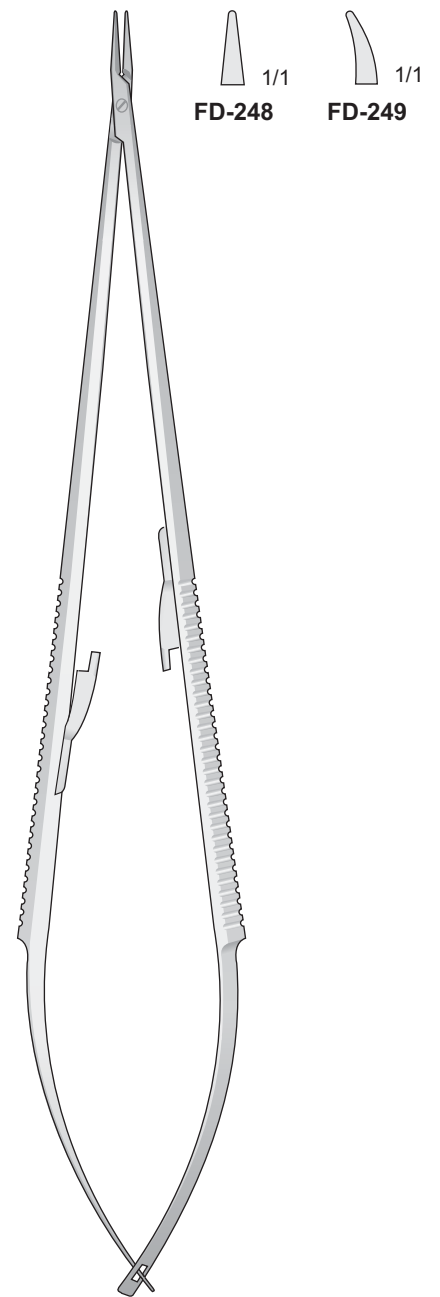

FD-248/FD-249
225 mm

Mikro Nadelhalter

Micro Needle Holders

Micro port'aghi

Micro portaagujas

Micro porte aiguilles

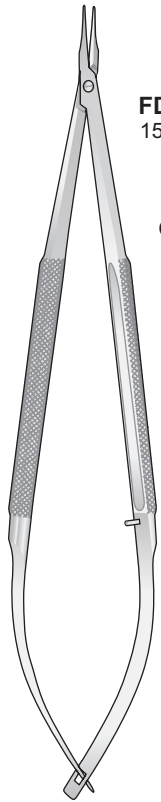

1/1
FD-152
150 mm

1/1
FD-153
150 mm

Glattes Maul
Smooth jaws
Con morso liscio
Mandibula lisa
A' mors lisses

BARRAQUER
FD-152/FD-153
150 mm

Glattes Maul
Smooth jaws
Con morso liscio
Mandibula lisa
A' mors lisses

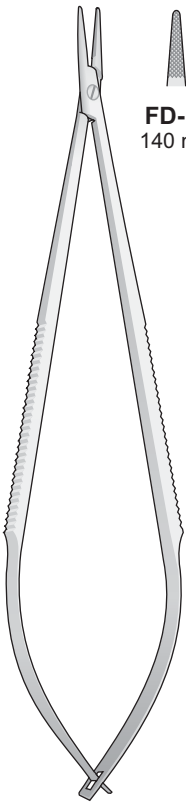

1/1
FD-14
140 mm

1/1
FD-16
140 mm

FD-14/FD-16
140 mm

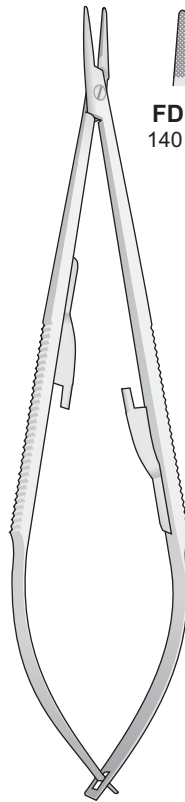

1/1
FD-18
140 mm

1/1
FD-20
140 mm

CASTROVIEJO
FD-18/FD-20
140 mm

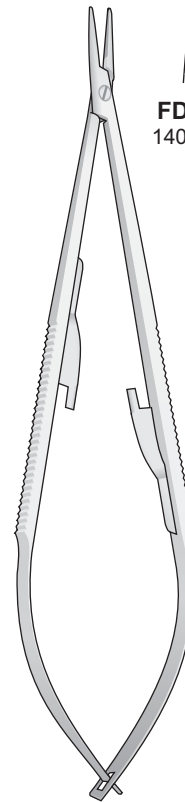

1/1
FD-17
140 mm

1/1
FD-19
140 mm

CASTROVIEJO
FD-17/FD-19
140 mm

Nadelhalter mit Hartmetalleinlagen
Needle Holders with tungsten-carbide inserts
Portaghi con inserti al tungsteno
Portaagujas con plaquitas de carburo de tungsteno
Porte aiguilles avec plaquettes en carbure de tungstène

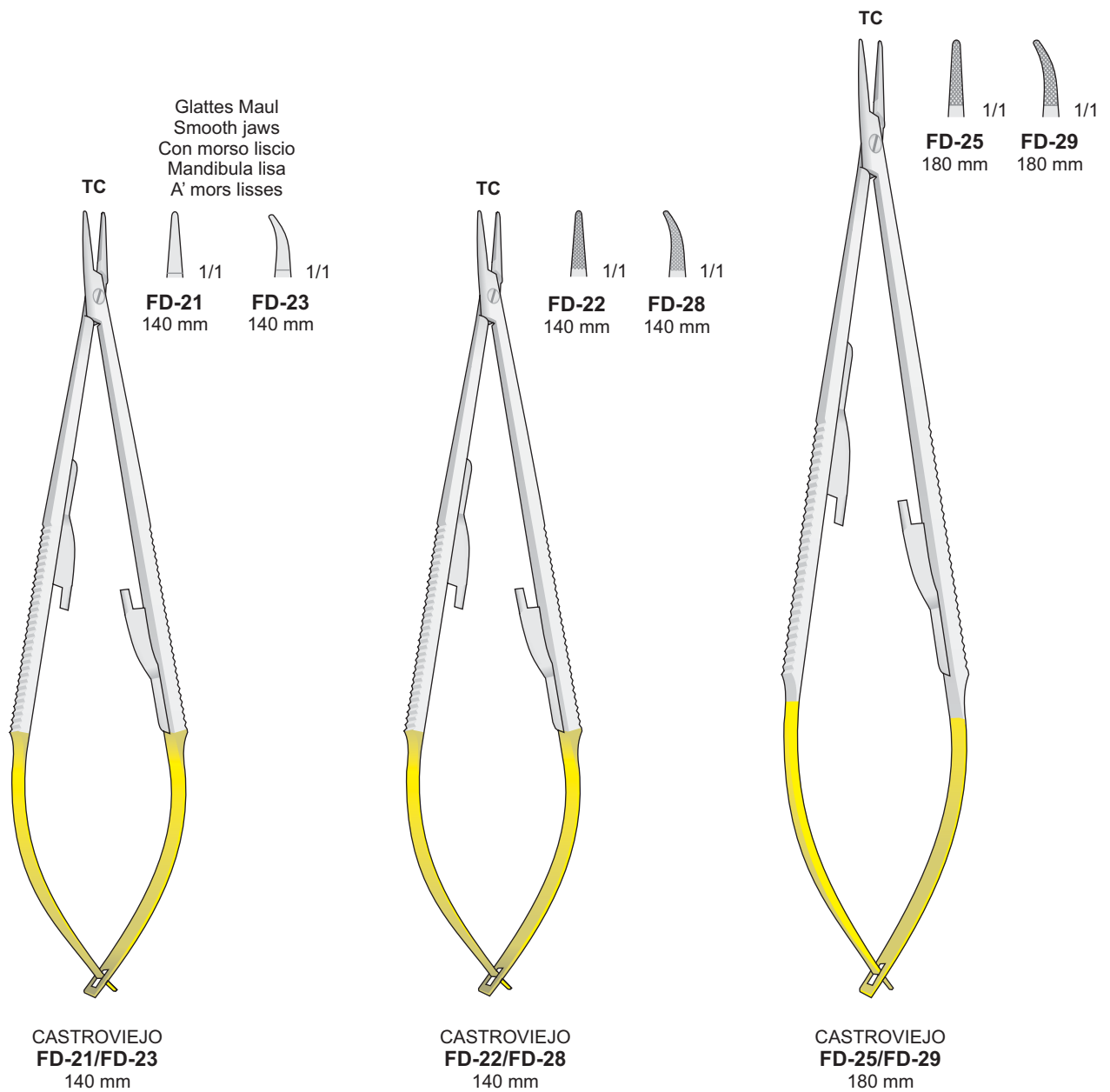

Nadelhalter mit Hartmetalleinlagen
Needle Holders with tungsten-carbide inserts
Portaghi con inserti al tungsteno
Portaagujas con plaquetas de carburo de tungsteno
Porte aiguilles avec plaquettes en carbure de tungstène

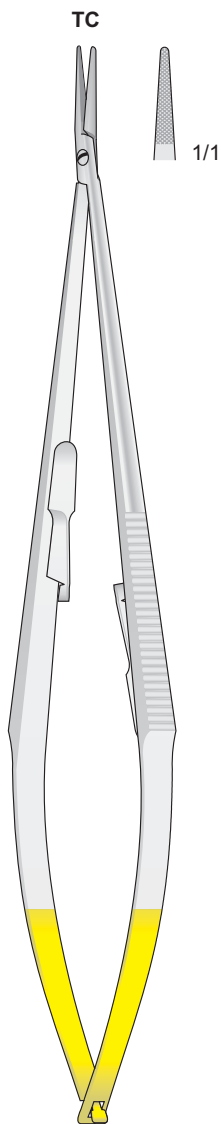

CASTROVIEJO
FD-27
215 mm

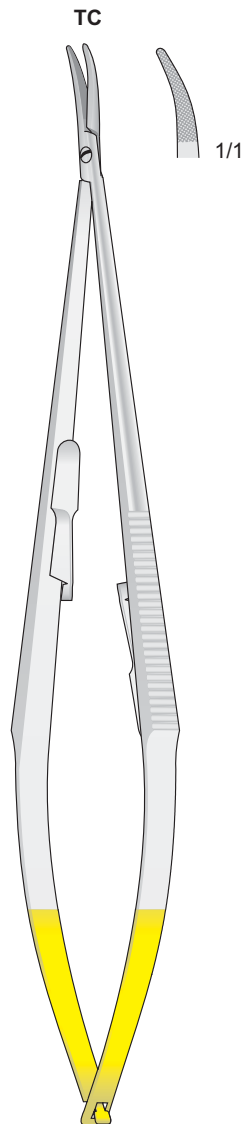

CASTROVIEJO
FD-128
215 mm

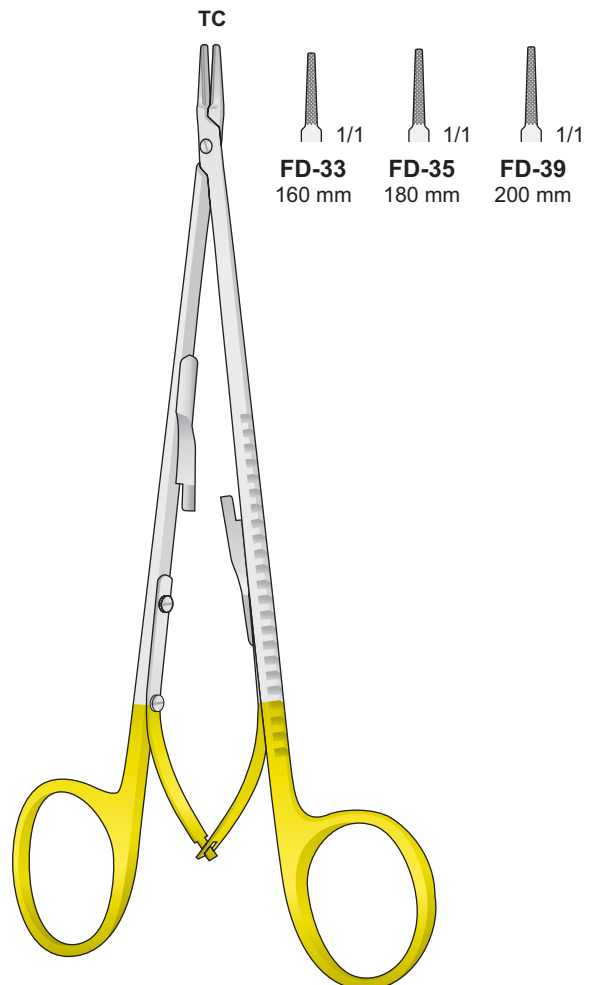

DIETRICH
FD-33/FD-39

Nadelhalter

Needle Holders

Port'aghi

Portaagujas

Porte aiguilles

Glattes Maul
With smooth jaws
Con morso liscio
Con mandibula lisa
Avec mors lisses

Glattes Maul
With smooth jaws
Con morso liscio
Con mandibula lisa
Avec mors lisses

Nadelhalter mit Hartmetalleinlagen
Needle Holders with tungsten-carbide inserts
Portaghi con inserti al tungsteno
Portaagujas con plaquetas de carburo de tungsteno
Porte aiguilles avec plaquettes en carbure de tungstène

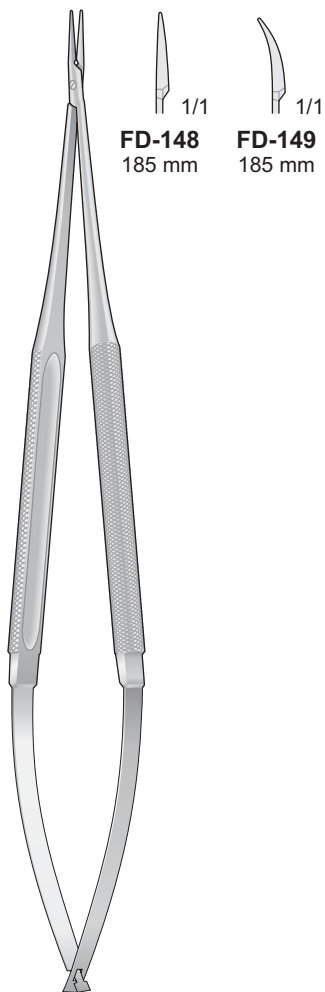

FD-148
185 mm

FD-149
185 mm

FD-148/FD-149
185 mm

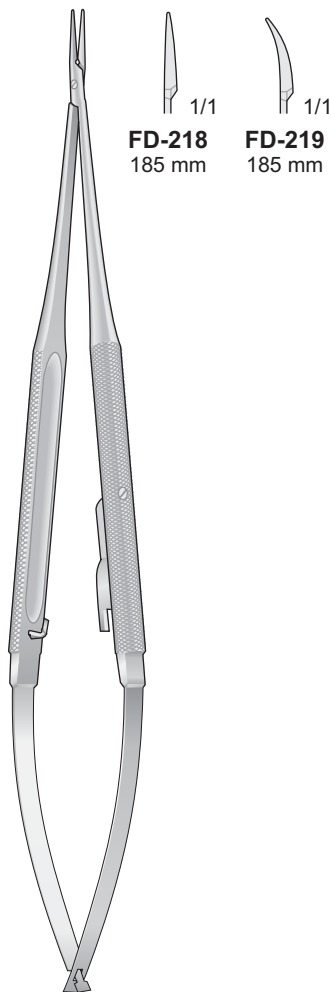

FD-218
185 mm

FD-219
185 mm

FD-218/FD-219
185 mm

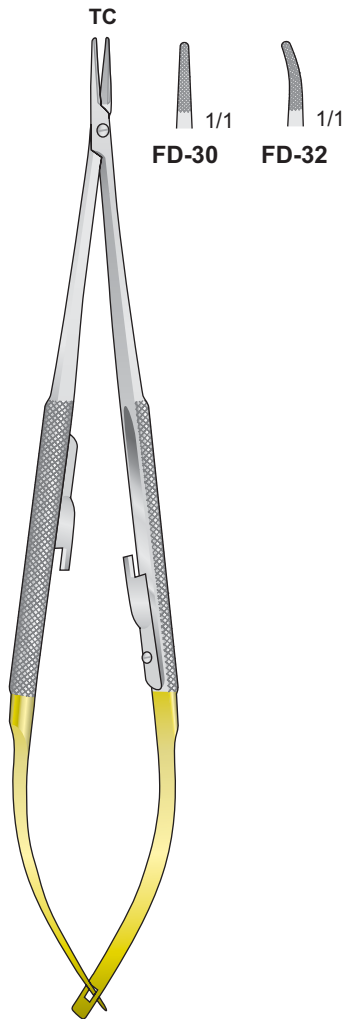

FD-30

FD-32

JACOBSON
FD-30/FD-32
180 mm

Nadelhalter mit Hartmetalleinlagen
Needle Holders with tungsten-carbide inserts
Portaghi con inserti al tungsteno
Portaagujas con plaquitas de carburo de tungsteno
Porte aiguilles avec plaquettes en carbure de tungstène

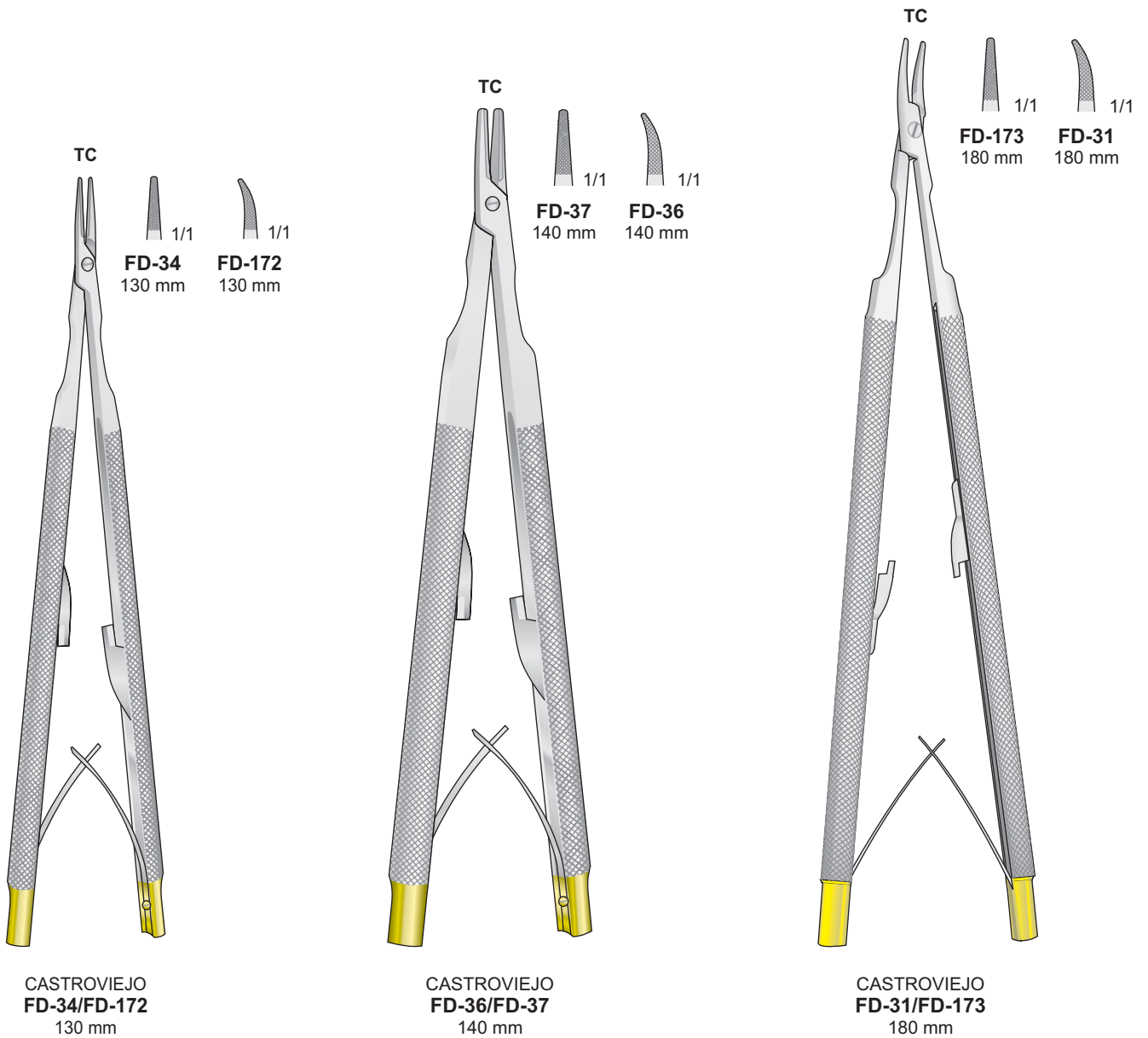

Nadelhalter

Needle Holders

Port'aghi

Portaagujas

Porte aiguilles

Glattes Maul
With smooth jaws
Con morso liscio
Con mandibula lisa
Avec mors lisses

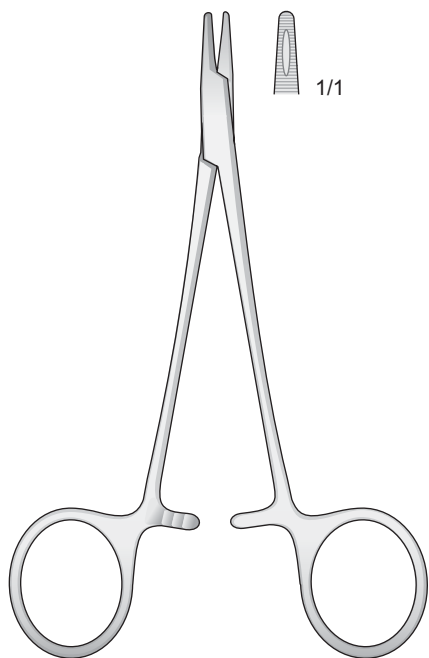

DERF
PH-39
125 mm

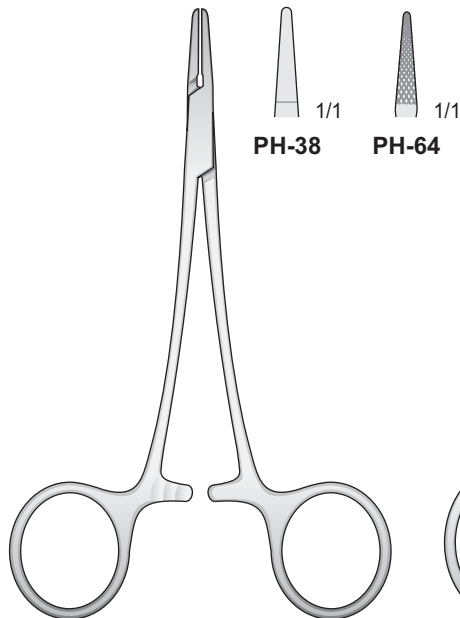

PH-38/PH-64
120 mm

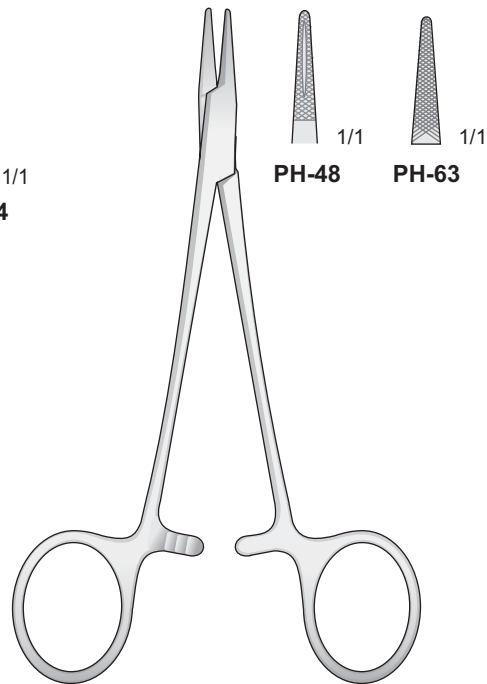

HALSEY
PH-48/PH-63
130 mm

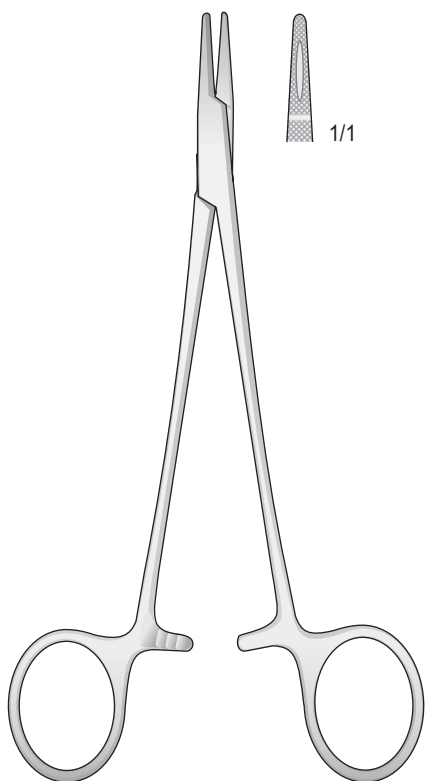

CRILE-WOOD
PH-61
150 mm

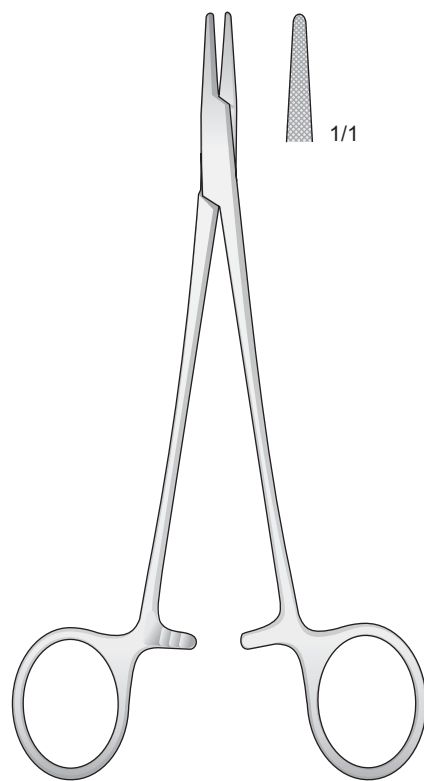

CRILE-MURRAY
PH-62
150 mm

Nadelhalter

Needle Holders

Port'aghi

Portaagujas

Porte aiguilles

Schlankes Modell - Delicate pattern - Modello fine
Modelo delegado - Modèle fin

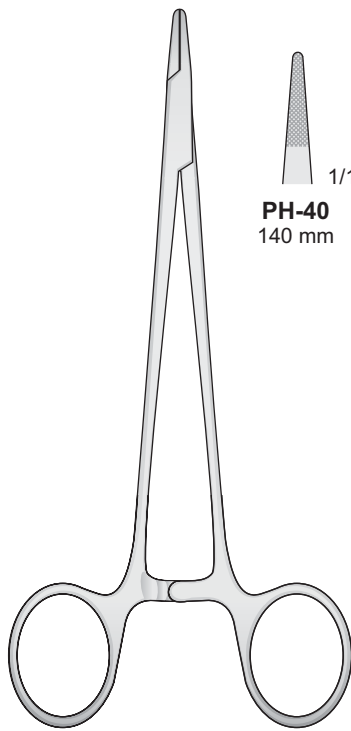

MAYO-HEGAR
PH-40/PH-45

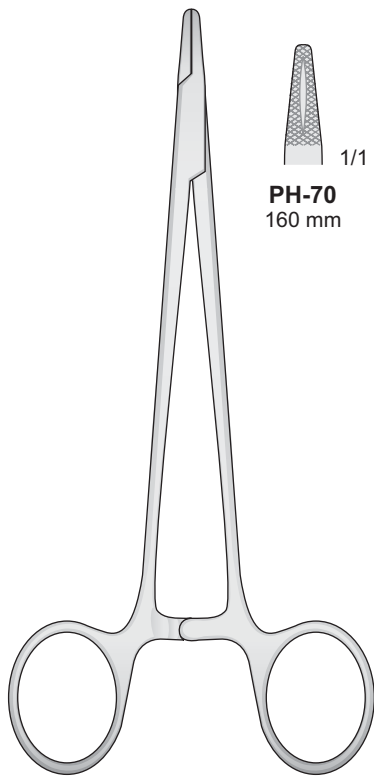
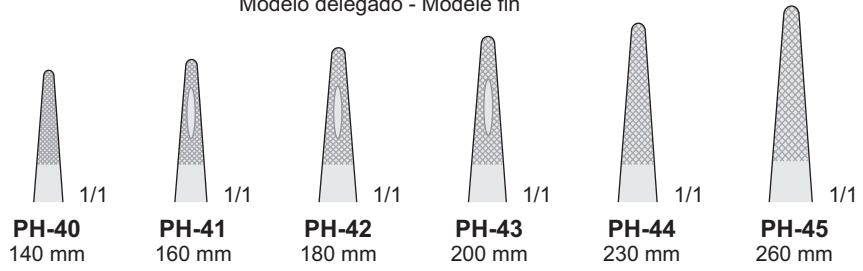

HEGAR
PH-70/PH-78

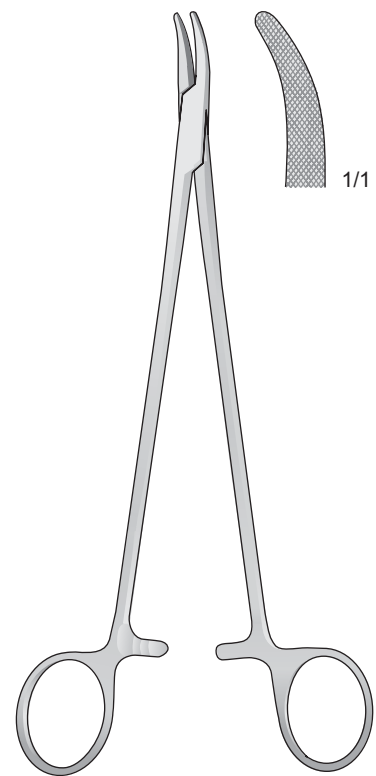
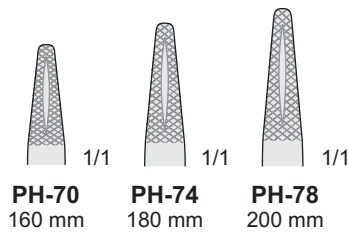

HEANEY (HEGAR)
PH-52
200 mm

Nadelhalter

Needle Holders

Port'aghi

Portaagujas

Porte aiguilles

Nadelhalter mit Schere - Needle holders with scissors
Port'aghi con forbici - Portaagujas con tijeras
Porte aiguilles avec ciseaux

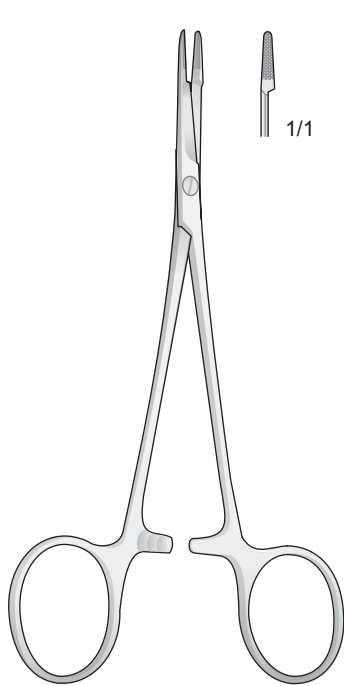

MINI-OLSEN-HEGAR
BM-61
120 mm

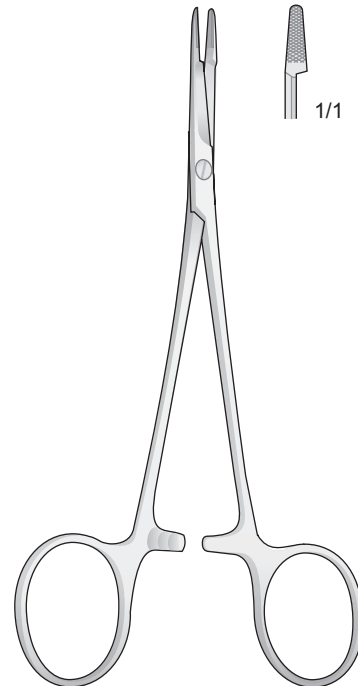

OLSEN-HEGAR
BM-62
140 mm

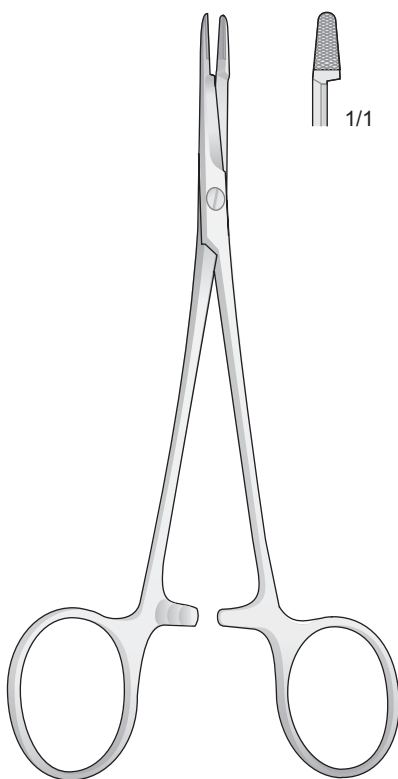

OLSEN-HEGAR
BM-63
170 mm

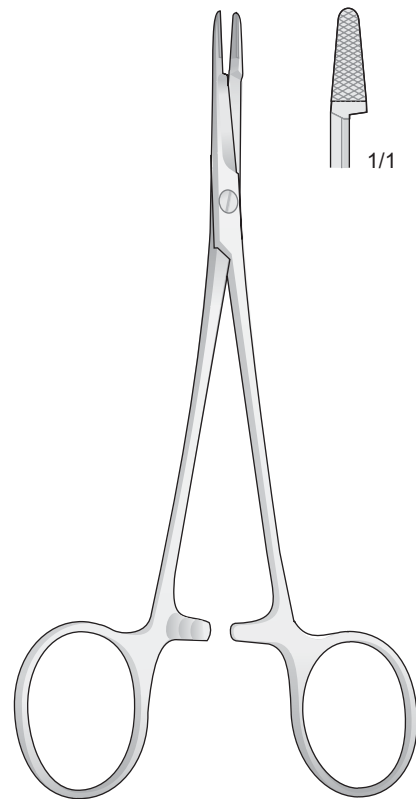

OLSEN-HEGAR
BM-64
190 mm

Nadelhalter mit Schere

Needle holders with
scissors

Port'aghi con forbici

Portaagujas con tijeras

Porte aiguilles avec
ciseaux

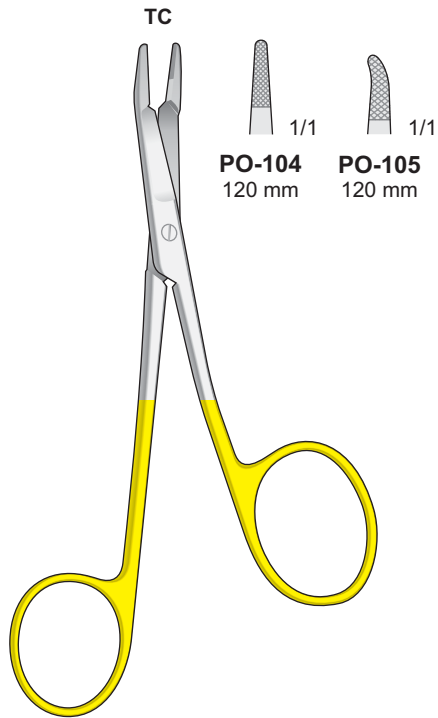

FOSTER-GILLIES
PO-104/PO-105
120 mm

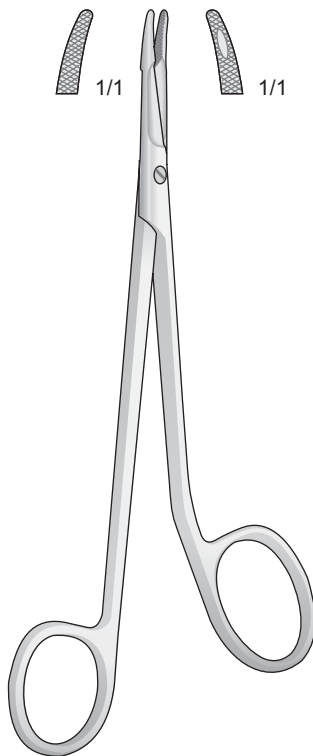

MINI-GILLIES
PO-59
145 mm

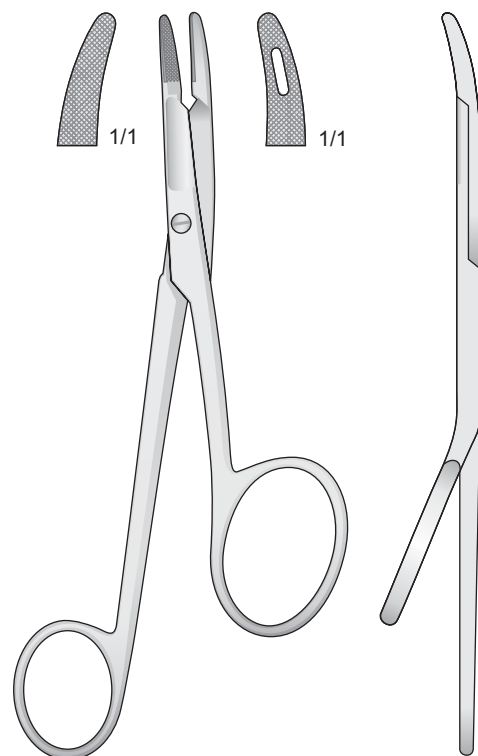

GILLIES
PO-89
160 mm

Nadelhalter

Needle Holders

Port'aghi

Portaagujas

Porte aiguilles

Nadelhalter mit Hartmetalleinlagen - Needle Holders with tungsten-carbide inserts
Portaghi con inserti al tungsteno - Portaagujas con plaquitas de carburo de tungsteno
Porte aiguilles avec plaquettes en carbure de tungstène

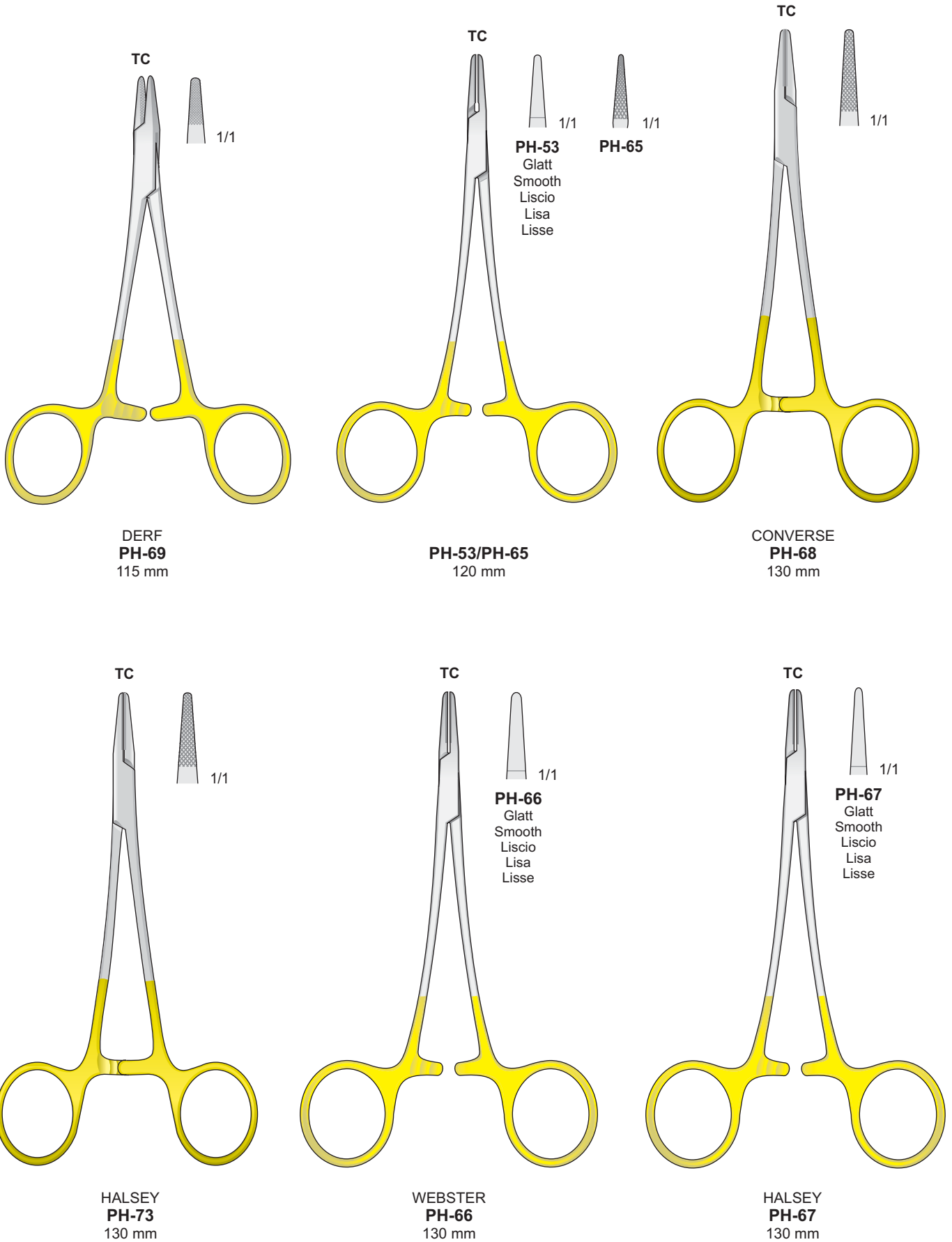

Nadelhalter

Needle Holders

Port'aghi

Portaagujas

Porte aiguilles

Nadelhalter mit Hartmetalleinlagen - Needle Holders with tungsten-carbide inserts
Portaghi con inserti al tungsteno - Portaagujas con plaquitas de carburo de tungsteno
Porte aiguilles avec plaquettes en carbure de tungstène

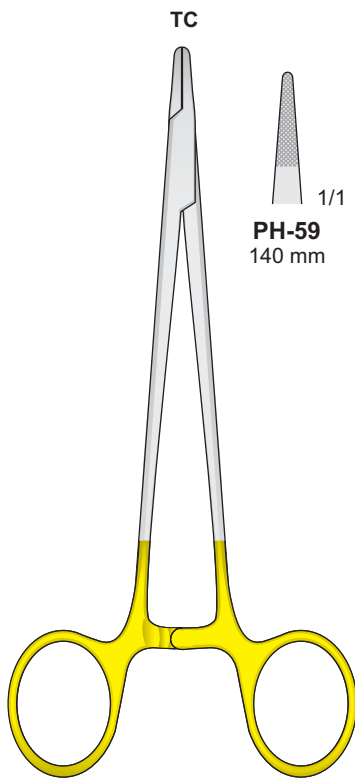

HEGAR
PH-59/PH-76

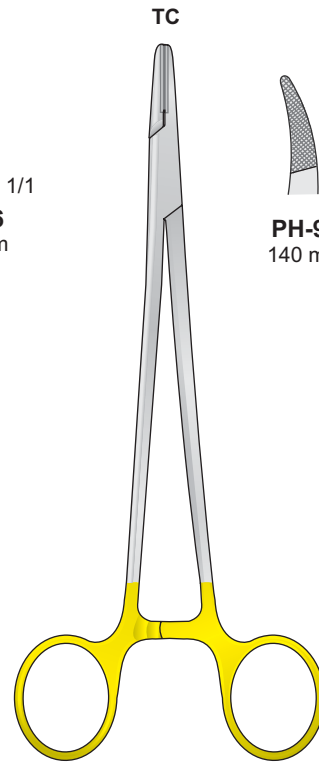
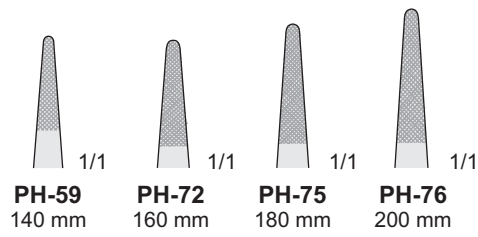

MAYO-HEGAR-HEANEY
PH-95/PH-97

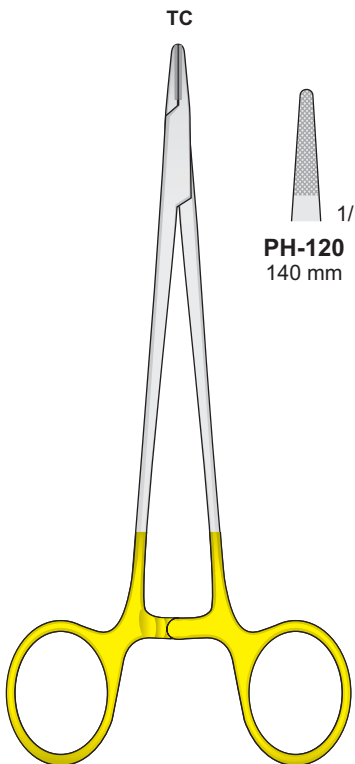
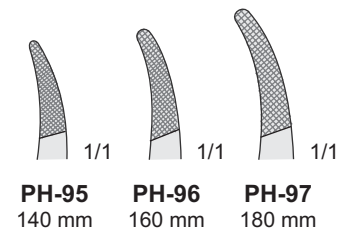

MAYO-HEGAR
PH-120/PH-125

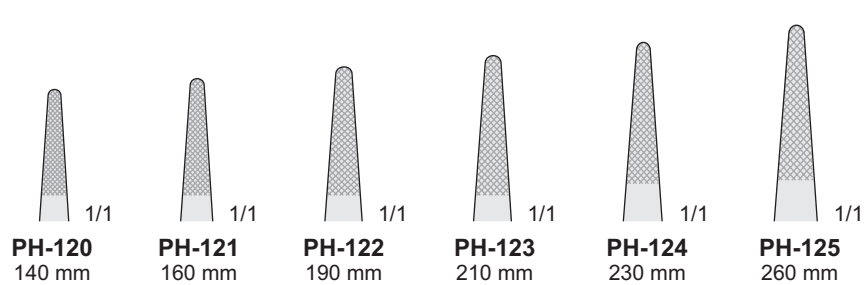

Nadelhalter

Needle Holders

Port'aghi

Portaagujas

Porte aiguilles

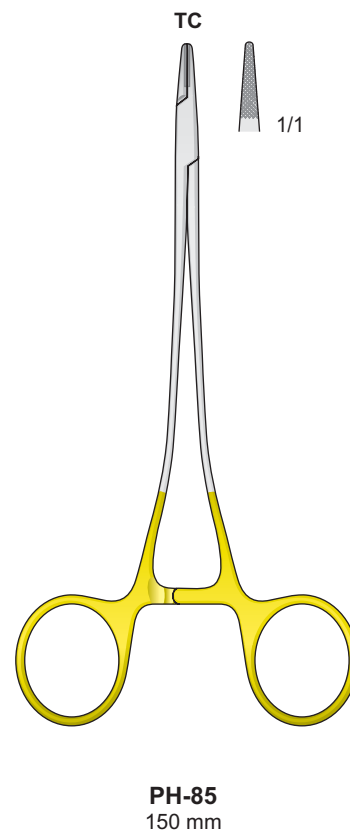
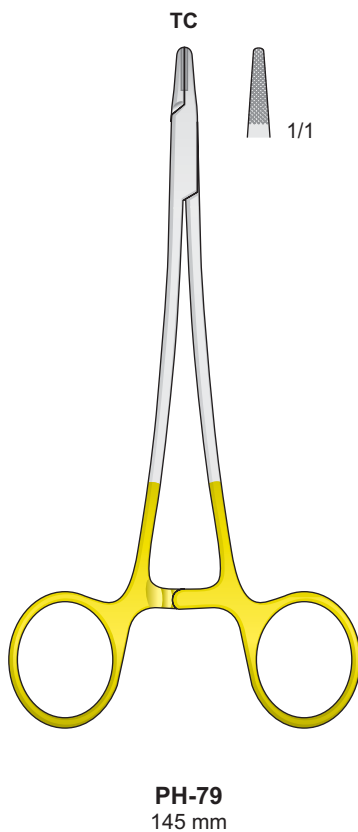
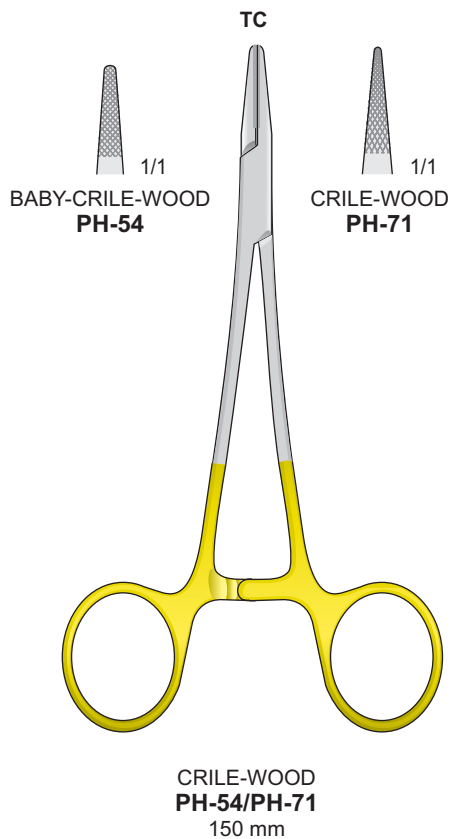
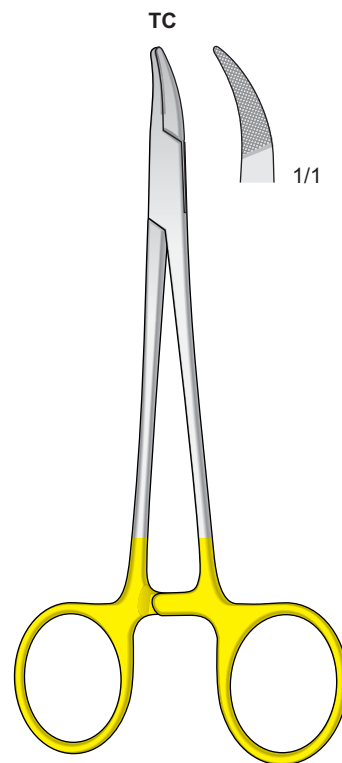
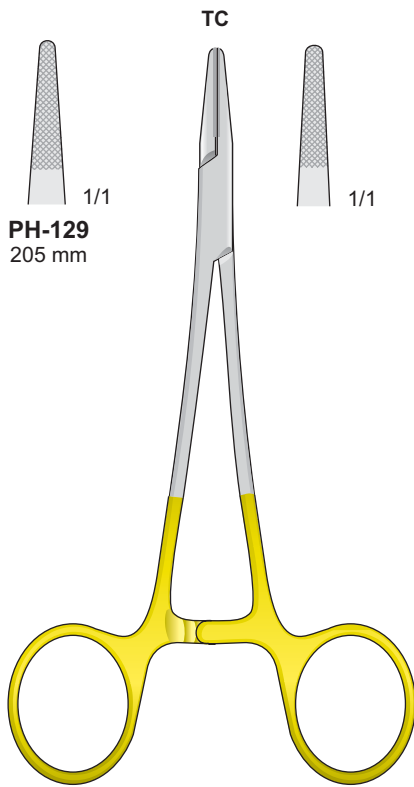
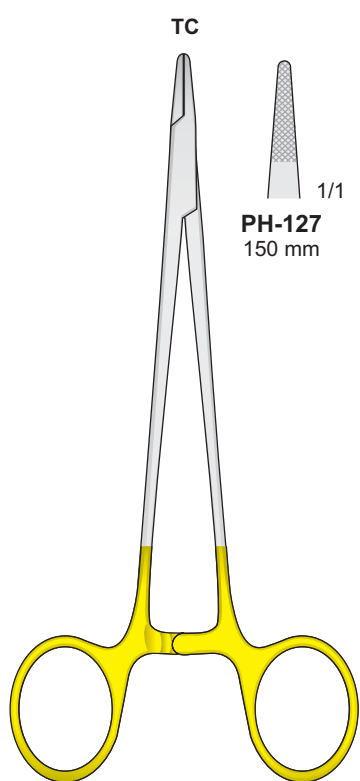

Nadelhalter mit Schere

Needle holders with
scissors

Port'aghi con forbici

Portaagujas con tijeras

Porte aiguilles avec
ciseaux

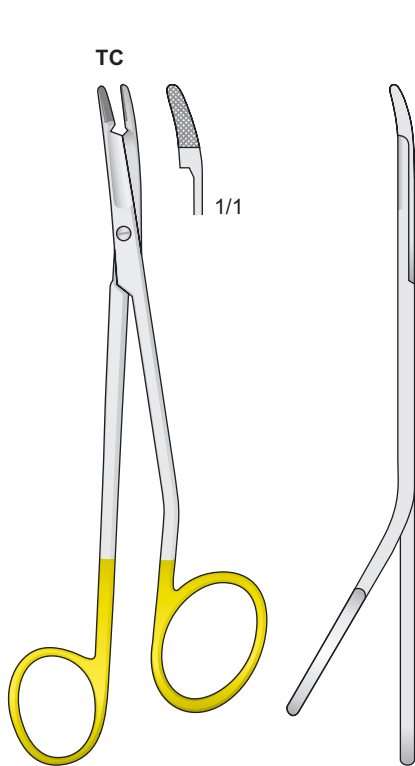

MINI-GILLIES
PO-99
145 mm

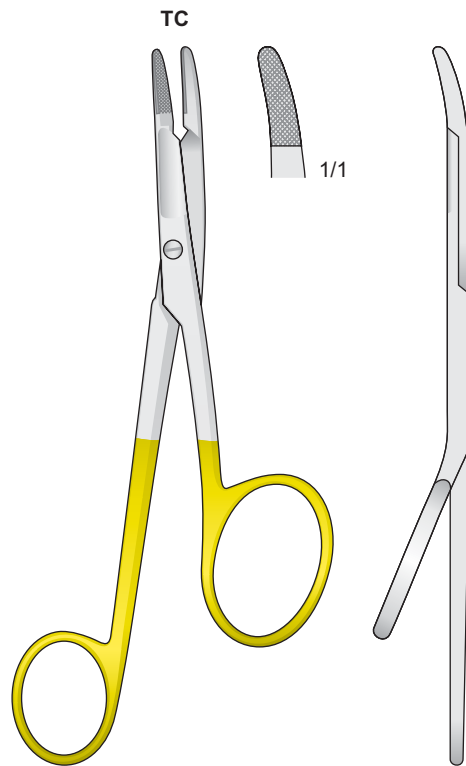

GILLIES
PO-97
160 mm

Für Linkshänder - Left Handed
Per mancini - Pour gauche - Para zurdos

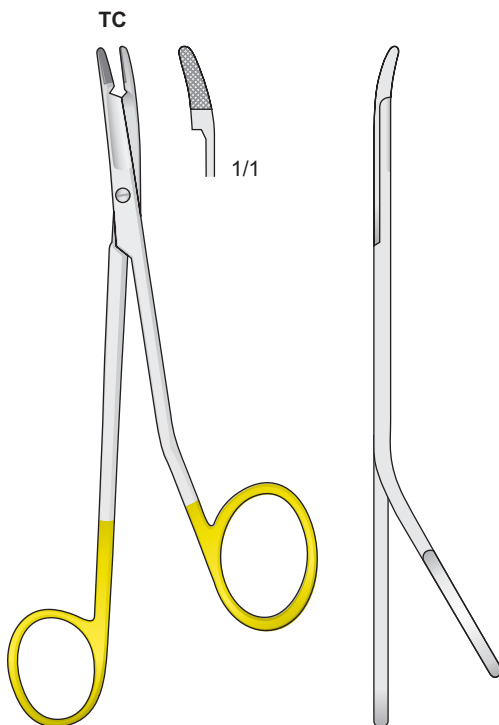

MINI-GILLIES
PO-99L
145 mm

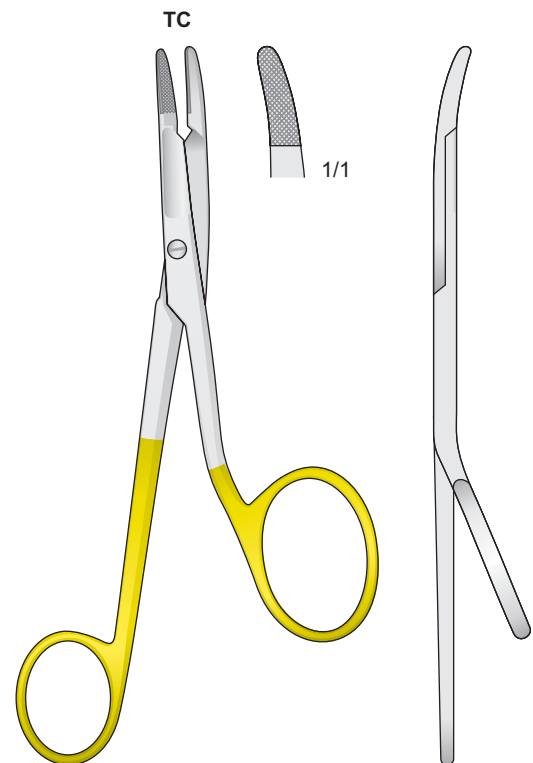

GILLIES
PO-97L
160 mm

Nadelhalter

Needle Holders

Port'aghi

Portaagujas

Porte aiguilles

Nadelhalter mit Hartmetalleinlagen - Needle Holders with tungsten-carbide inserts
Portaghi con inserti al tungsteno - Portaagujas con plaquitas de carburo de tungsteno
Porte aiguilles avec plaquettes en carbure de tungstène

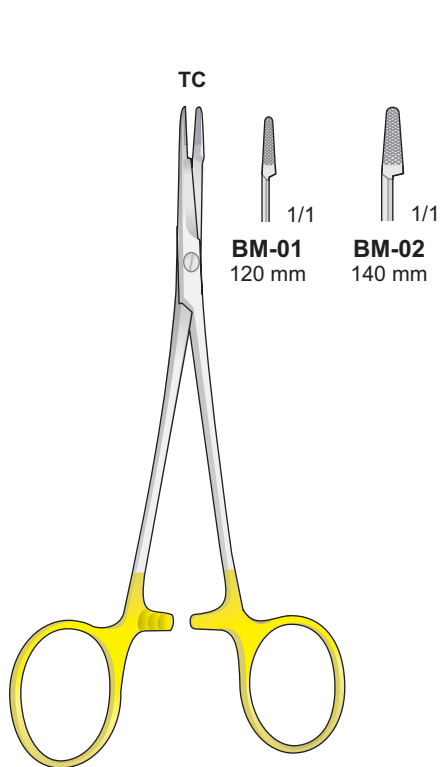

OLSEN-HEGAR
BM-01/BM-02

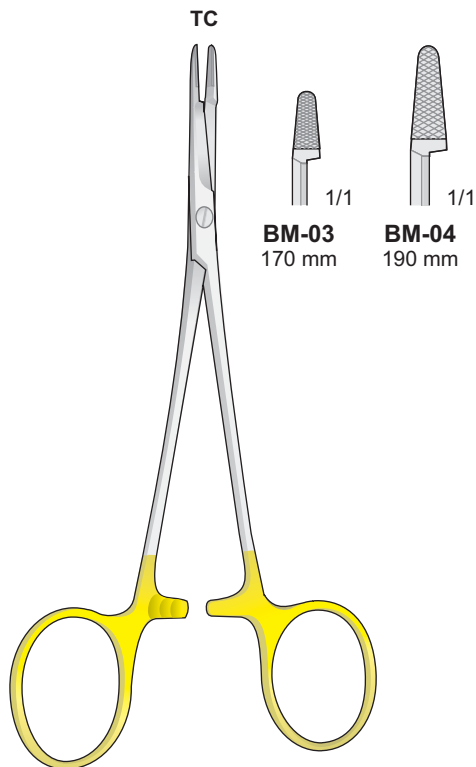

OLSEN-HEGAR
BM-03/BM-04

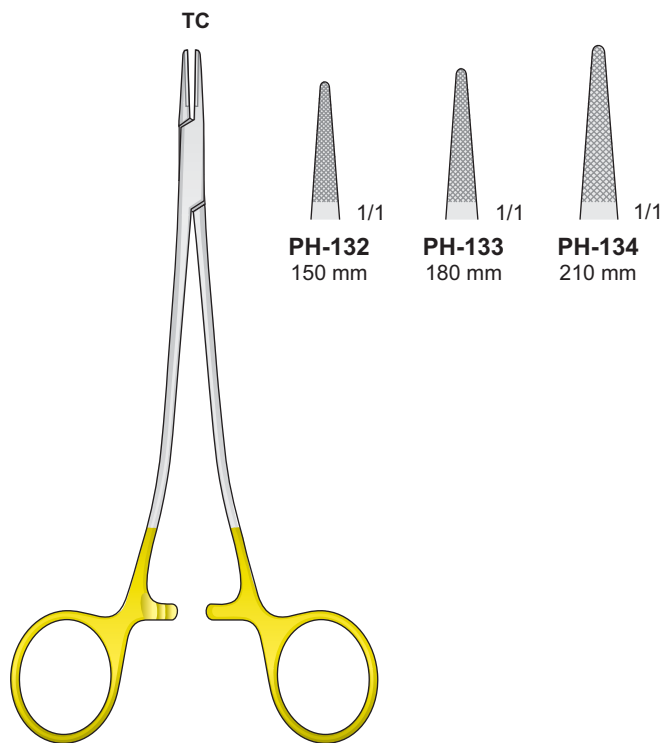

SAROT
PH-132/PH-134

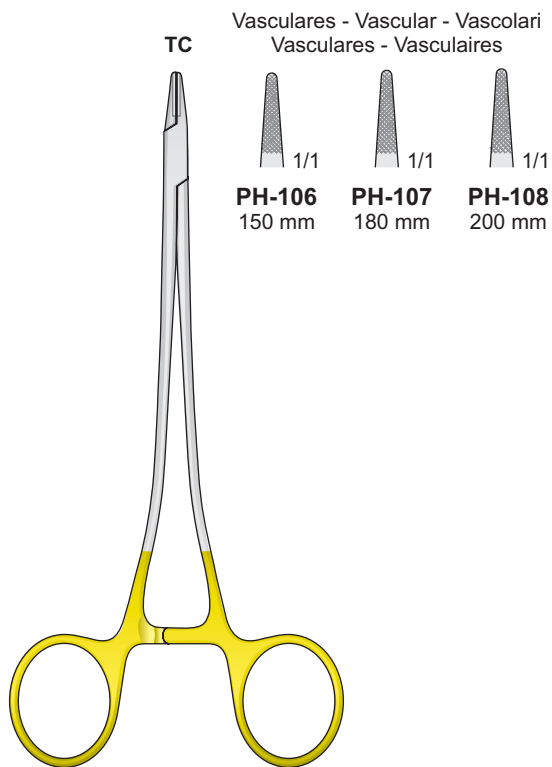

SWEDESH MOD.
PH-106/PH-108

Nadelhalter

Needle Holders

Port'aghi

Portaagujas

Porte aiguilles

Nadelhalter mit Hartmetalleinlagen - Needle Holders with tungsten-carbide inserts
Portaghi con inserti al tungsteno - Portaagujas con plaquitas de carburo de tungsteno
Porte aiguilles avec plaquettes en carbure de tungstène

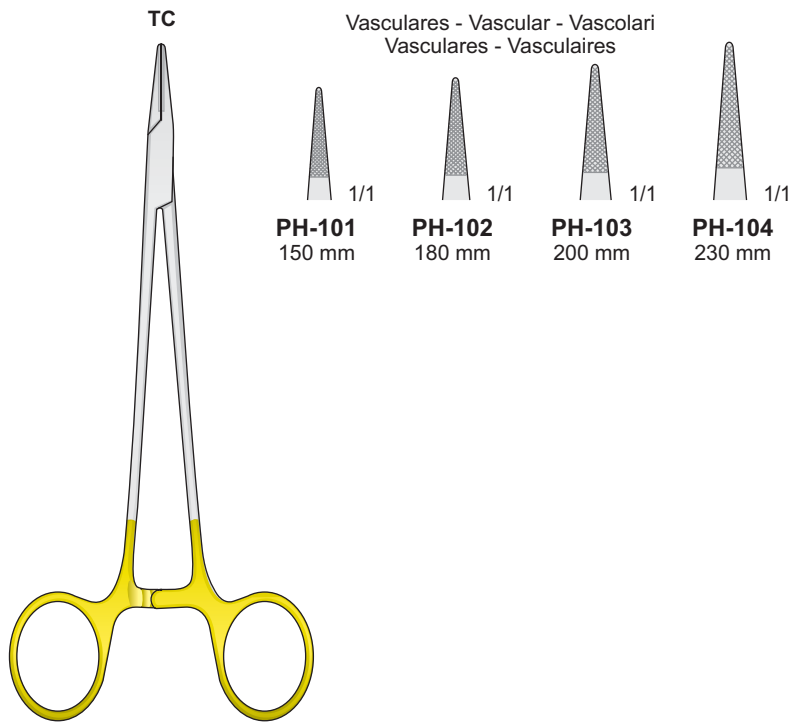

MICRO-VASCULAR
PH-101/PH-104

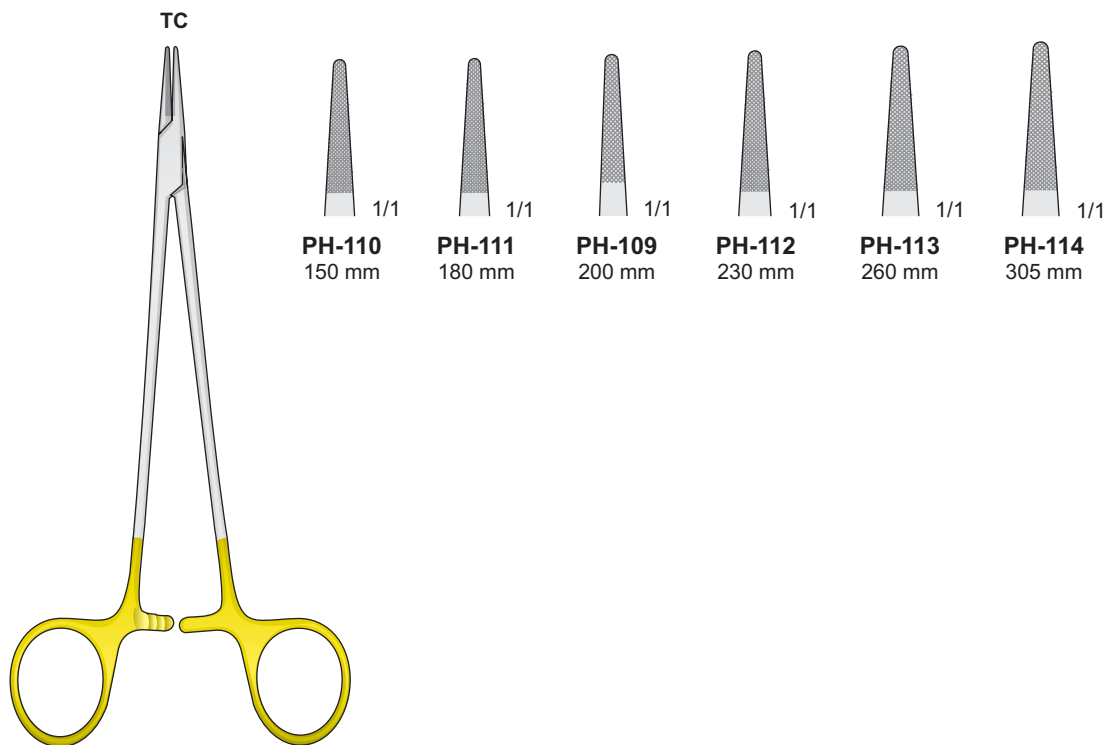

DE BAKEY
PH-109/PH-114

Nadelhalter

Needle Holders

Port'aghi

Portaagujas

Porte aiguilles

Nadelhalter mit Hartmetalleinlagen - Needle Holders with tungsten-carbide inserts
Portaghi con inserti al tungsteno - Portaagujas con plaquitas de carburo de tungsteno
Porte aiguilles avec plaquettes en carbure de tungstène

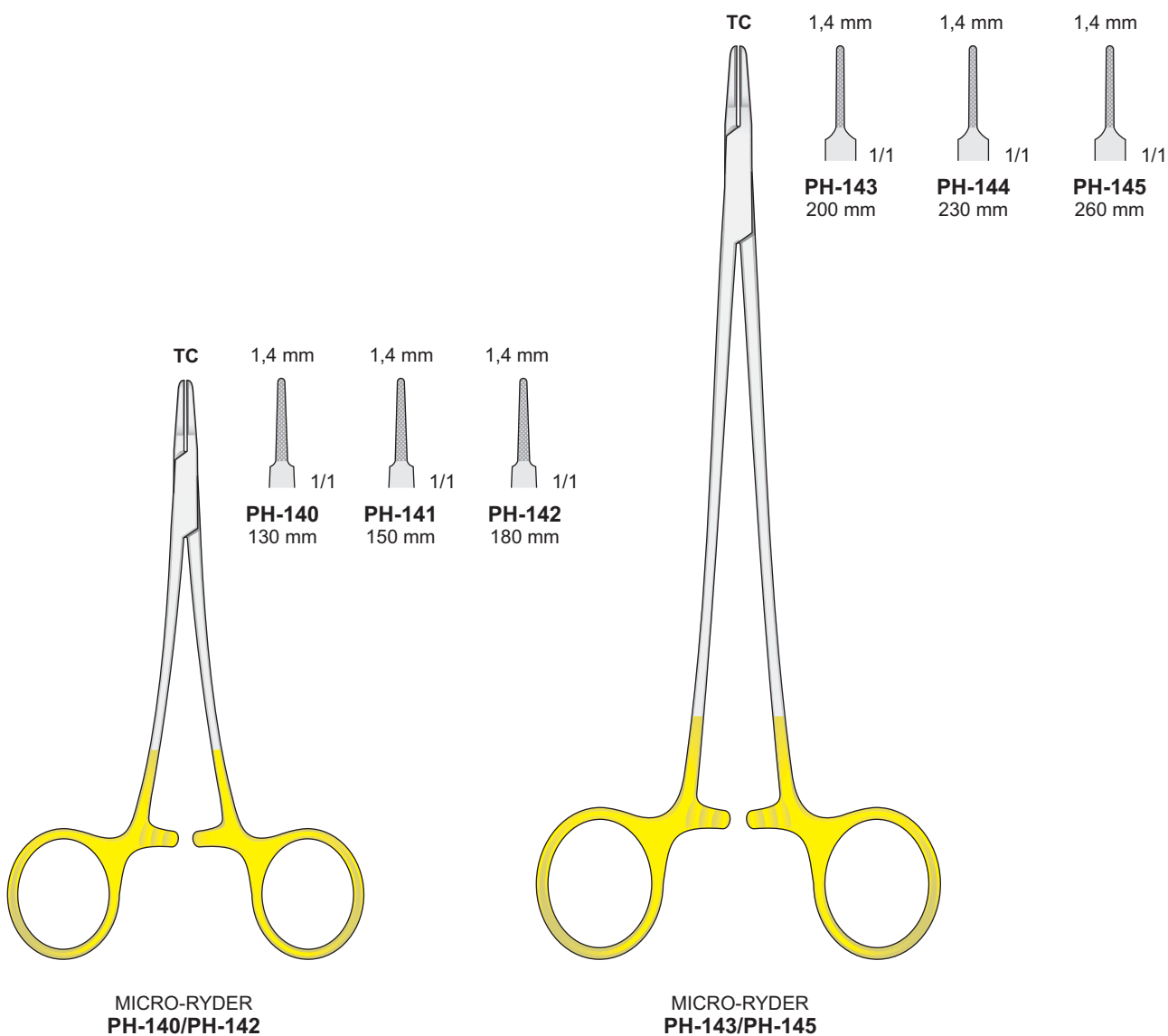

Nadelhalter

Needle Holders

Port'aghi

Portaagujas

Porte aiguilles

Nadelhalter mit Hartmetalleinlagen - Needle Holders with tungsten-carbide inserts
Portaghi con inserti al tungsteno - Portaagujas con plaquitas de carburo de tungsteno
Porte aiguilles avec plaquettes en carbure de tungstène

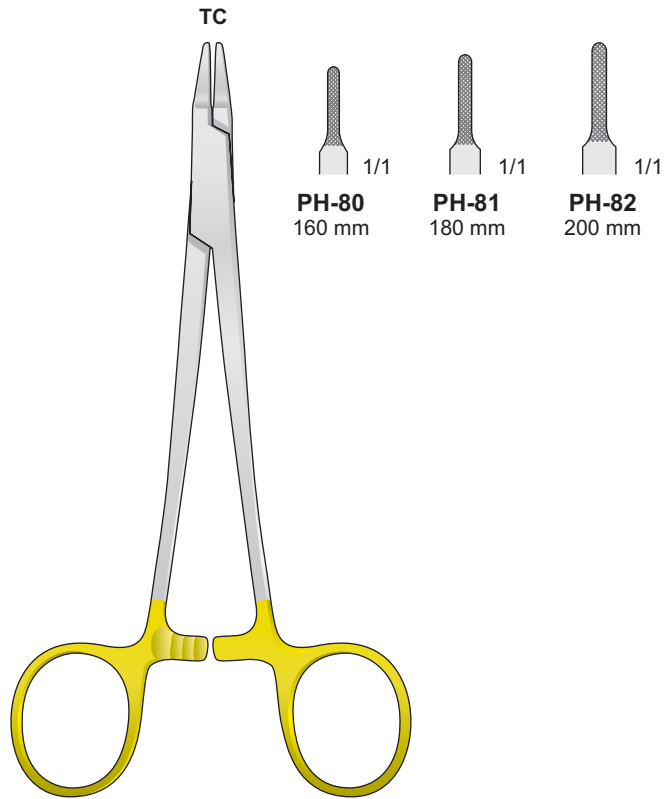

RYDER
PH-80/PH-82

Ein Ring Abgewinkelt
One ring angled
Un anello angolato
Un anneau décalé

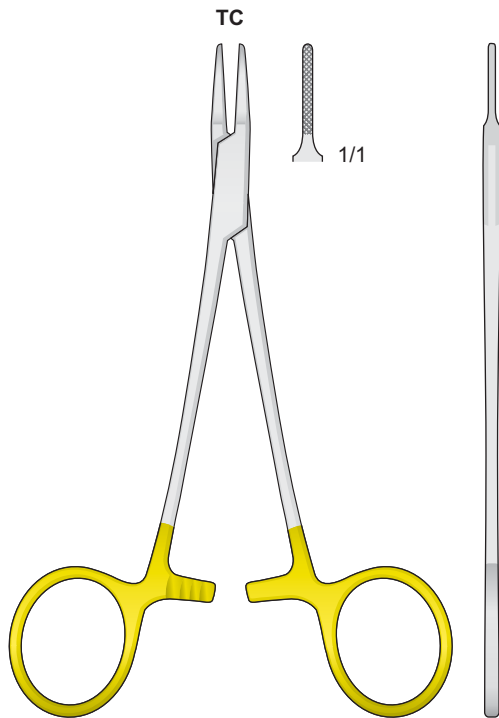

MICRO-RYDER
PH-83
140 mm

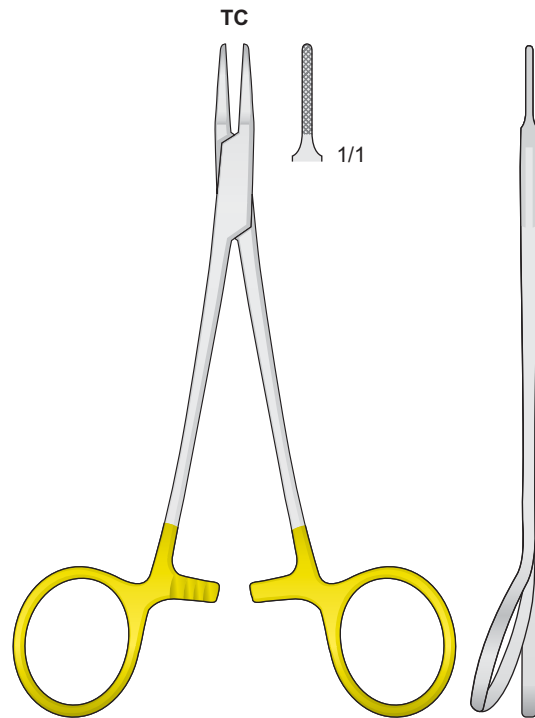

PH-84
140 mm

Nadelhalter

Needle Holders

Port'aghi

Portaagujas

Porte aiguilles

Nadelhalter mit Hartmetalleinlagen - Needle Holders with tungsten-carbide inserts
Portaghi con inserti al tungsteno - Portaagujas con plaquitas de carburo de tungsteno
Porte aiguilles avec plaquettes en carbure de tungstène

Ein Ring abgewinkelt
One ring angled
Un anello angolato
Un anneau décalé

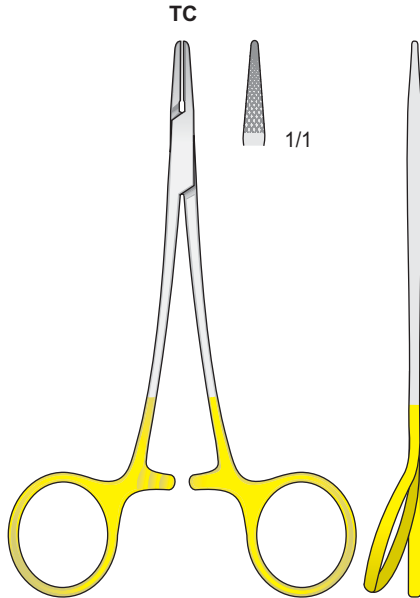

PH-99
120 mm

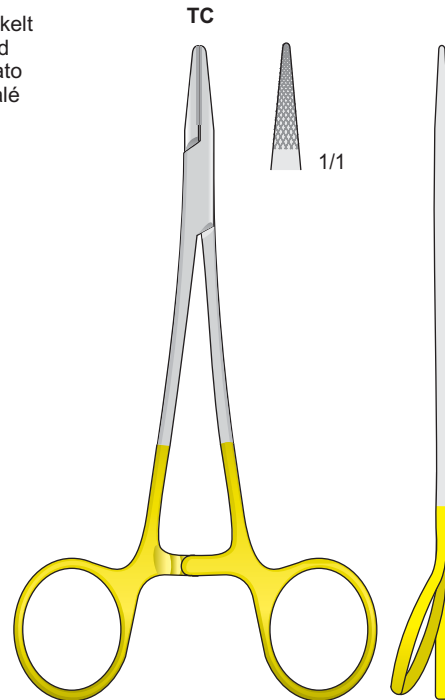

CRILE-WOOD
PH-100
150 mm

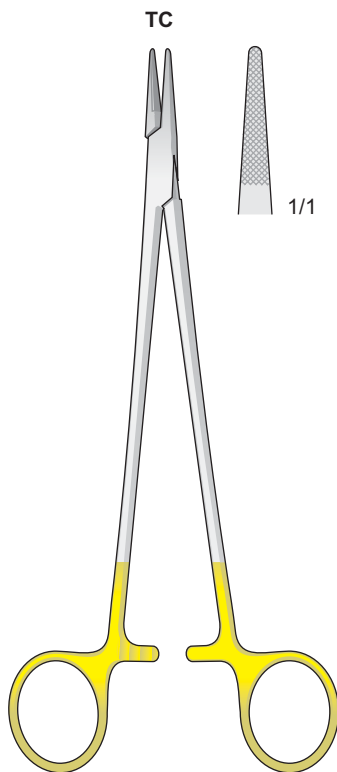

HEGAR-MAYO-SEELEY
PH-130
200 mm

Nadelhalter, Draht-Zangen - Needle holder, wire forceps
Port'aghi per fili d'acciaio - Porta agujas, pinzas para hilos
Porte-aiguilles, pinces à saisir

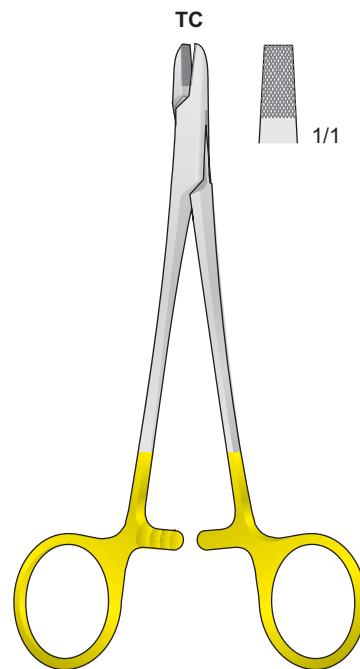

PH-58
150 mm

Nadelhalter

Needle Holders

Port'aghi

Portaagujas

Porte aiguilles

Nadelhalter mit Hartmetalleinlagen - Needle Holders with tungsten-carbide inserts
Port'aghi con inserti al tungsteno - Portaagujas con plaquitas de carburo de tungsteno
Porte aiguilles avec plaquettes en carbure de tungstène

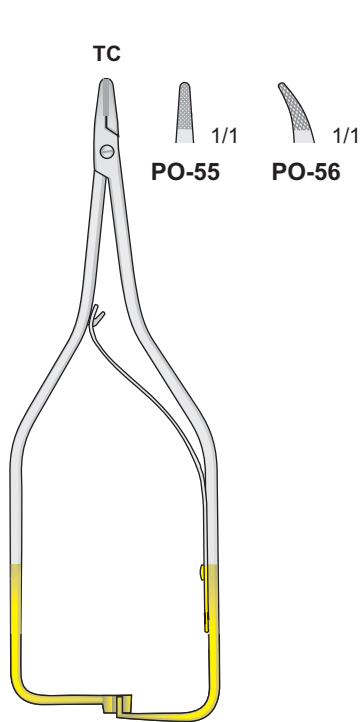

BOYNTON
PO-55/PO-56
120 mm

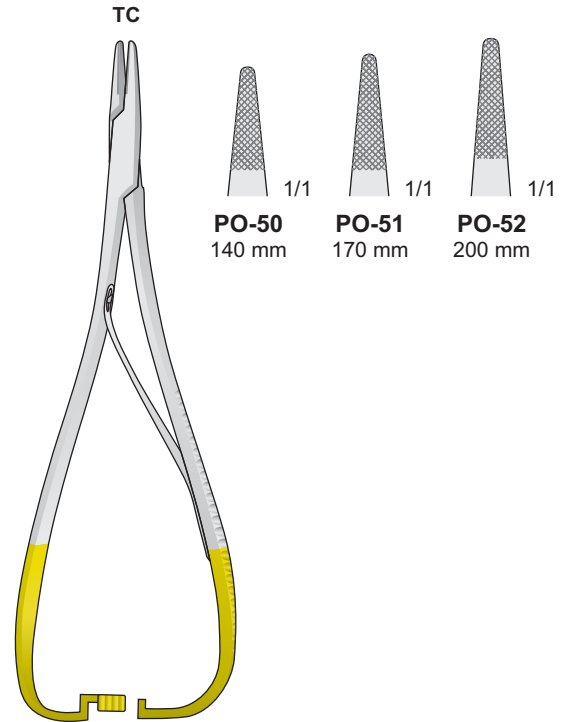

MATHIEU
PO-50/PO-52

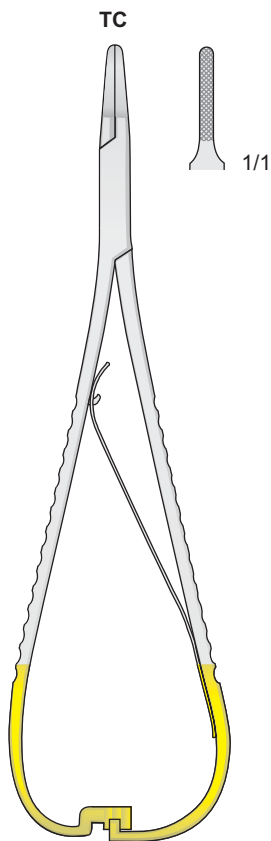

LICHTENBERG
PO-86
175 mm

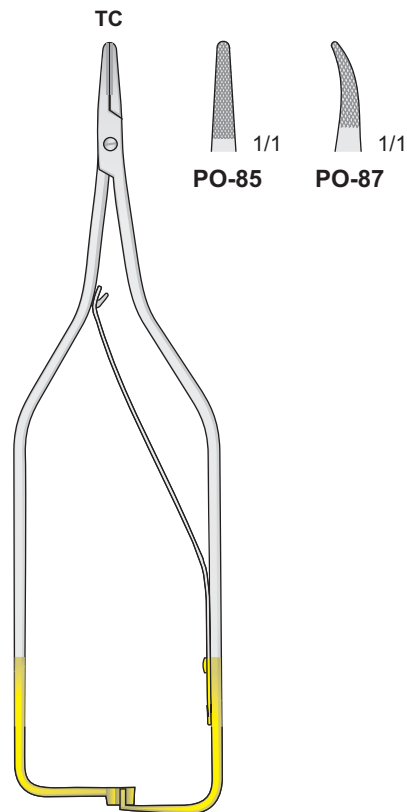

ARRUGA
PO-85/PO-87
160 mm

Gefäßclips

Vessel Clips

Clamps vascolari

Clamps vasculaires

Clamps vasculares

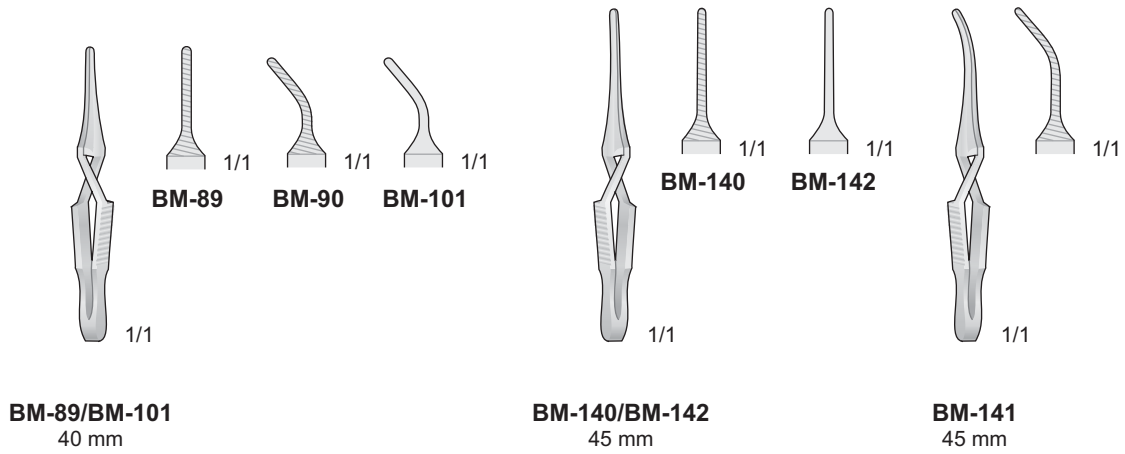
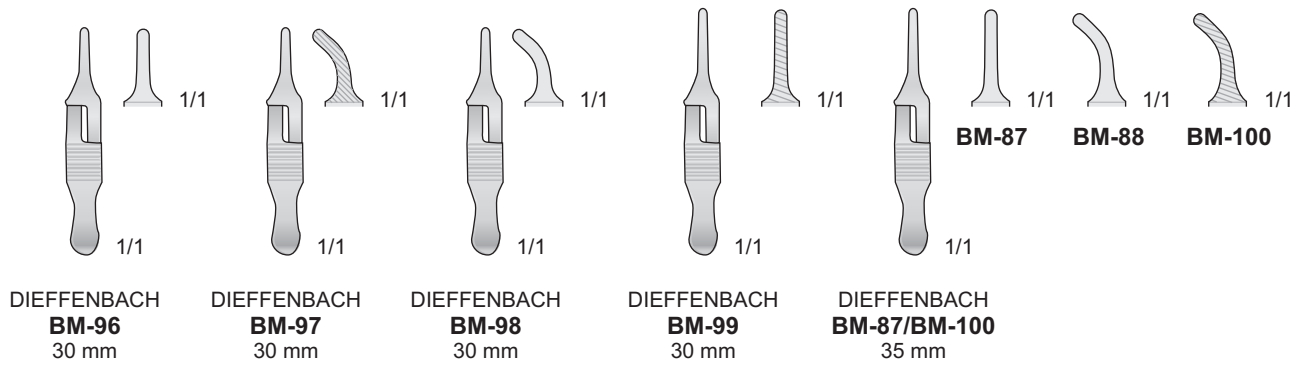

BIEMER
FD-500/FD-502

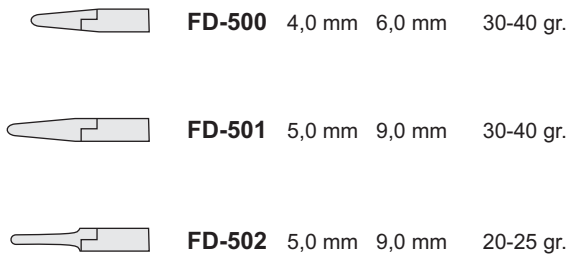

MEDHORN
FD-503/FD-506

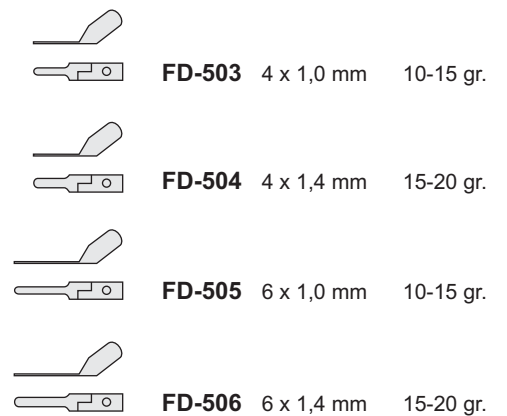

Gefäßklemmen Acland

Vascular Clamps Acland

Clamps Acland
Vascolari

Clamps vasculaires
Acland

Clamps vasculares
Acland

8 mm



Ø Gefäß / Vessel
0,4 - 1,0 mm

Einzelklemmen
Single Clamp



Vene - Vein
Arterie - Artery
FE-21
FE-22

Einzelklemmen
Single Clamp



FE-27
FE-28

Approximator
Approximator



FE-37
FE-38

Approximator
Approximator



FE-43
FE-44

Doppelklemmen
Double Clamp



FE-49
FE-50

11 mm

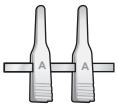

Ø Gefäß / Vessel
0,6 - 1,5 mm



Vene - Vein
Arterie - Artery
FE-23
FE-24



FE-29
FE-30

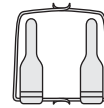

FE-39
FE-40

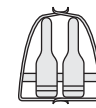

FE-45
FE-46

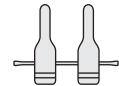

FE-51
FE-52

17 mm

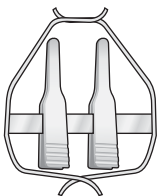

Ø Gefäß / Vessel
1,0 - 2,25 mm



Vene - Vein
Arterie - Artery
FE-25
FE-26



FE-31
FE-32

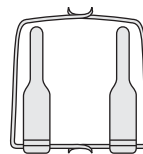

FE-41
FE-42

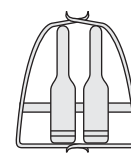

FE-47
FE-48

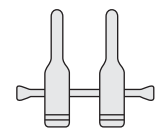

FE-53
FE-54

25 mm



Ø Gefäß / Vessel
1,5 - 3,5 mm



Vene - Vein
Arterie - Artery
FE-33
FE-34

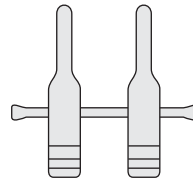

FE-55
FE-56

Klemmen-Anlegepinzette
Clamp Applying Forceps



36 mm



Ø Gefäß / Vessel
2,0 - 5,0 mm



Vene - Vein
Arterie - Artery
FE-35
FE-36

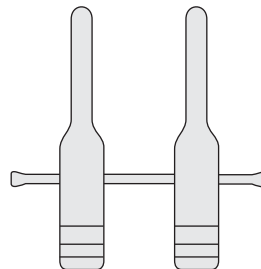

FE-57
FE-58

FE-59 mit Schloß, with lock
FE-60 ohne Schloß, without lock
140 mm

Approximatoren

Approximators

Approssimatori

Approximateurs

Approximateurs

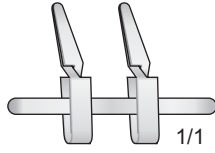

BIEMER-MÜLLER
FD-507/FD-511

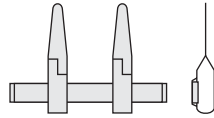

FD-507 5,0 mm 9,0 mm 25-30 gr.

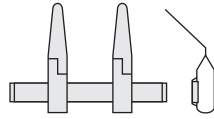

FD-508 5,0 mm 9,0 mm 25-30 gr.

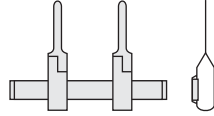

FD-509 5,0 mm 9,0 mm 25-30 gr.

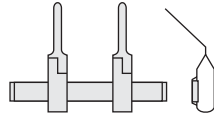

FD-510 5,0 mm 9,0 mm 25-30 gr.

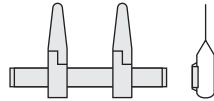

FD-511 3,5 mm 4,5 mm 25-30 gr.

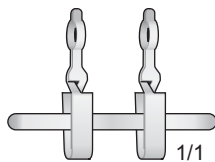

MÜLLER
FD-512/FD-515

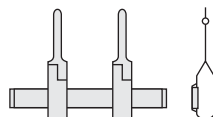

FD-512 Ø 1,0 mm 25-30 gr.

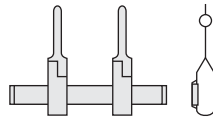

FD-513 Ø 2,0 mm 25-30 gr.

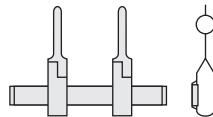

FD-514 Ø 3,0 mm 25-30 gr.

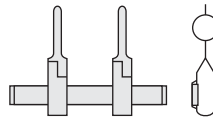

FD-515 Ø 4,0 mm 25-30 gr.

Schlüssel
Key - Chiave
Llave - Clef

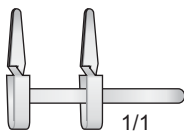

BIEMER
FD-517

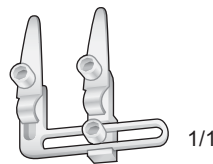

FD-518

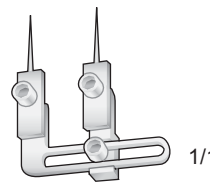

BIEMER
FD-519

FD-517

Approximator allein
Approximator only

FD-518

Approximator mit Schlüssel
Approximator with key

FD-519

Approximator mit Schlüssel
Approximator with key

FD-520

1 Paar Ersatznadeln
1 Pair of spare needles

Mikro Ohrzängchen

Micro Ear forceps

Micro Pinze auricolari

Pinzas auriculares finas

Micro Pincers
auriculaires

Mikro-Löffelzängchen
Micro cup shaped forceps
Micro pinza a cucchiaio
Micro pinza con boca
en forma de cucharilla
Pince à cuillère

0,9 x 1,0 mm



DB-86

Mikro-Scheren
Micro scissors
Micro forbici
Micro Tijeras
Micro Ciseaux



**BELLUCCI
DB-106**

1,0 mm



**WULLSTEIN
DB-91**



DB-93

0,9 x 1,1 mm



DB-205

4,0 x 0,5 mm



Maulteille Gerieft
Serrated Jaws
Morsi zigrinati
Boca estriada
Mors striés

DB-215

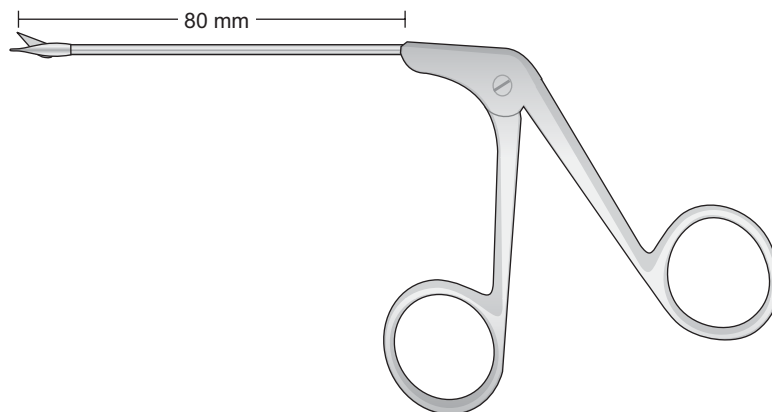

DB-86/DB-215
80 mm

Unterbindungsnadeln

Ligature needles

Aghi per legature

Agujas para ligaduras

Aiguilles à ligatures

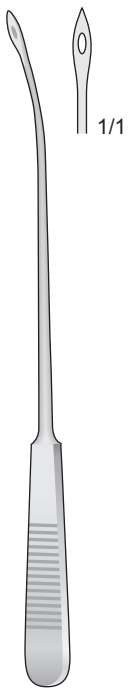

OBWEGESER
DO-30
140 mm

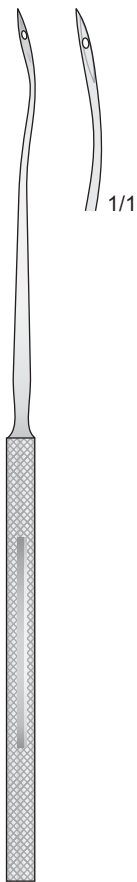

YANKAUER
BM-151
170 mm

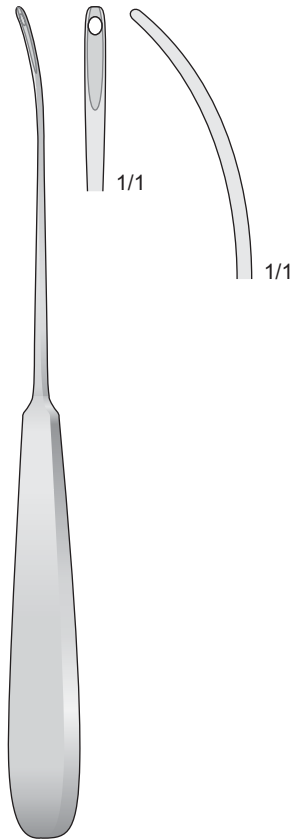

BM-28
200 mm

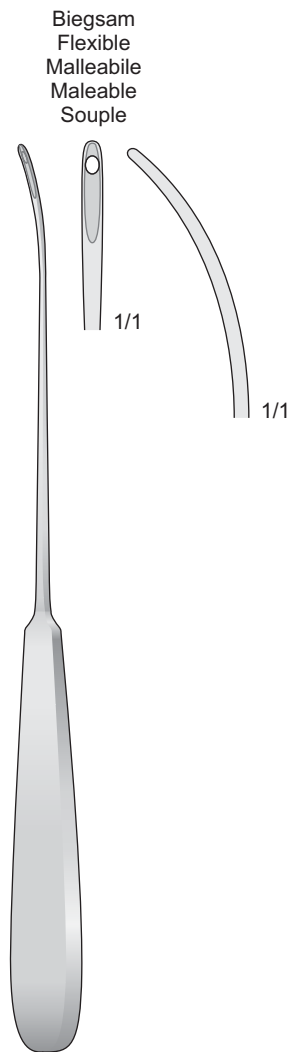

BM-74
230 mm

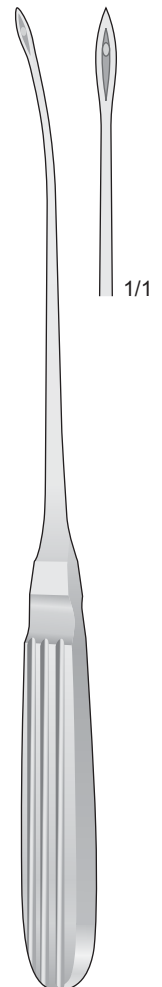

OBWEGESER
DO-31
230 mm

Sonden

Probes

Sonde bottonute

Estiletos

Sondes

Ø 1 mm



Ø 1,5 mm



Ø 2 mm



Ø 2 mm



Ø 1,5 mm

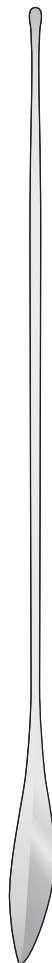

Ø 1,0 mm



Aus Silber
Sterling Silver
In argento
De plata en argent



PF-20 145 mm	PF-32 130 mm	PF-27 145 mm	PF-36 130 mm
PF-21 160 mm	PF-22 145 mm	PF-23 160 mm	PF-15 145 mm
	PF-25 160 mm	PF-28 200 mm	PF-29 160 mm
	PF-26 200 mm	PF-44 250 mm	PF-38 200 mm

PF-7
145 mm

STACKE
PF-14
110 mm

BOWMANN
PF-30 00/0 **PF-34** 5/6
PF-31 1/2 **PF-35** 7/8
PF-33 3/4 **PF-37** 6/7

Watteträger

Cotton applicators

Porta cotone

Portaalgodòn

Porte cotons

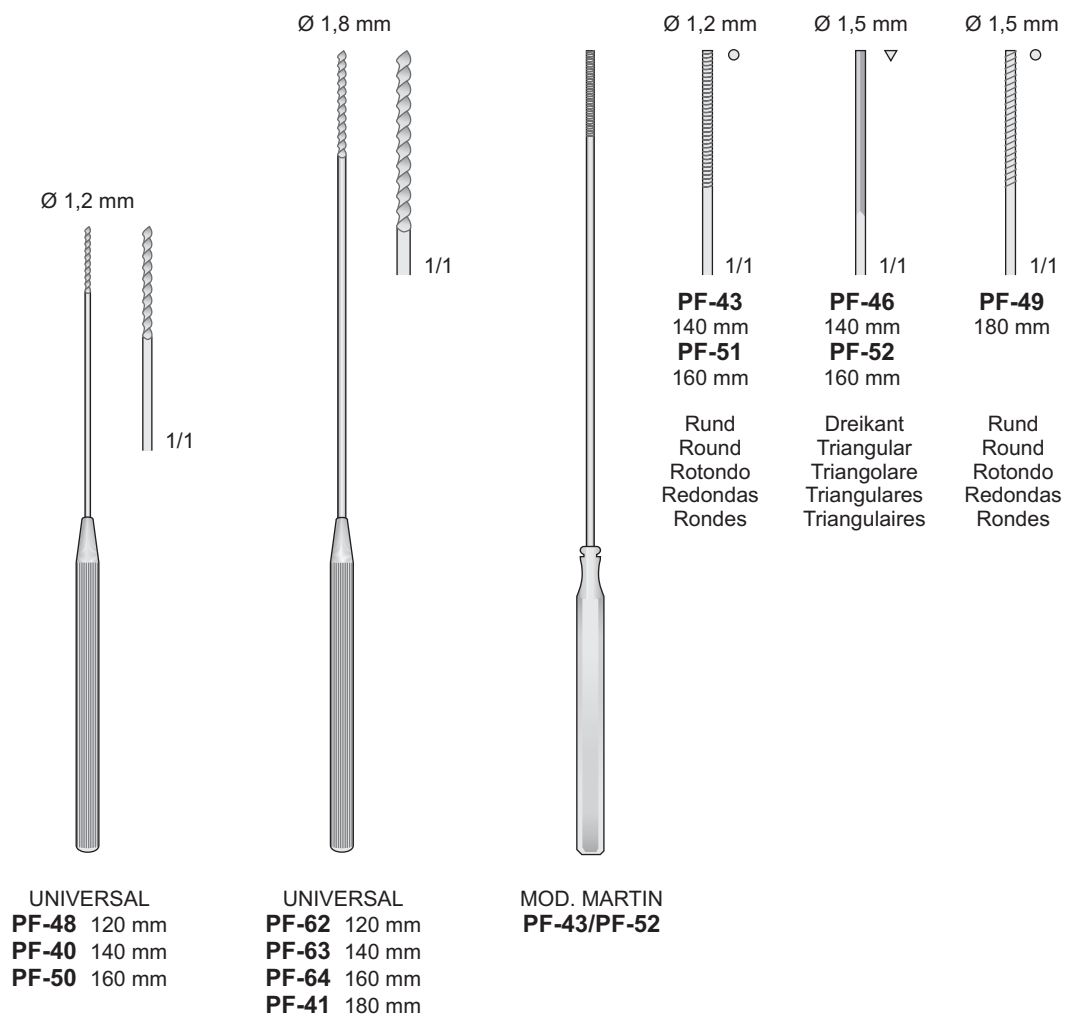

Mundsperrer

Mouth gags

Apribocca

Abrebocas

Ecarteur buccal

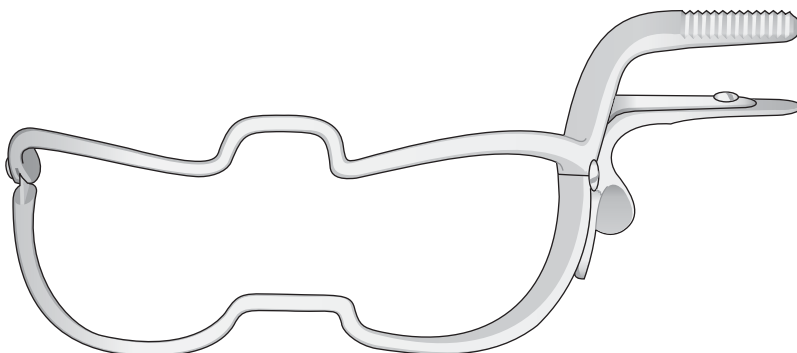

WHITEHEAD-JENNINGS

- OM-136** 90 mm
- OM-137** 110 mm
- OM-138** 130 mm
- OM-139** 150 mm

KILNER-DOUGHTY

OM-160

Komplett mit 3 Zungenspatel
Complete with 3 tongue depressors
Completo con 3 abbassalingua
Completo con 3 abaja lengua
Complet avec 3 abaisse-langues

Sperrer allein
Gag only
Apribocca solo
Apre-boca suelto
Manche et cadreseuls

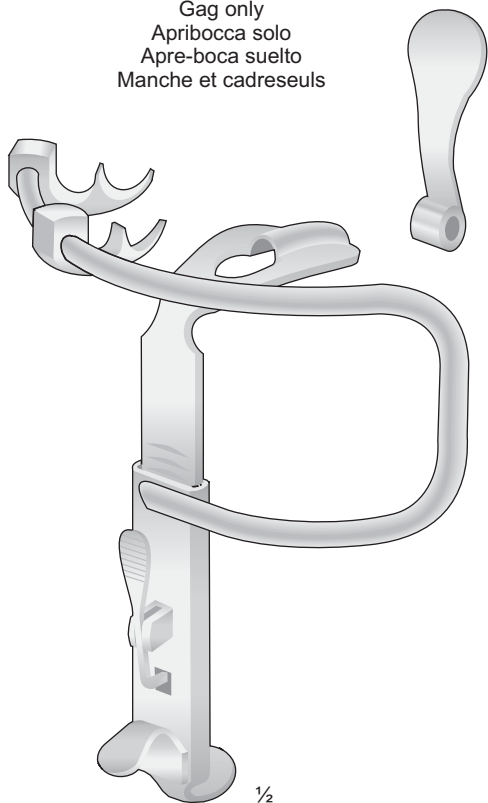

KILNER-DOUGHTY
OM-161

Fig. 1

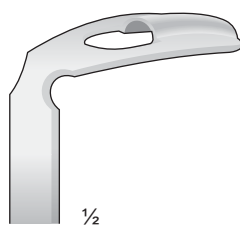

OM-162
28 x 65 mm

Fig. 2

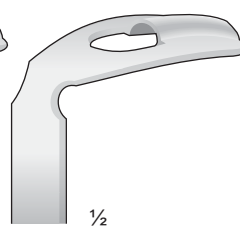

OM-163
32 x 75 mm

Fig. 3

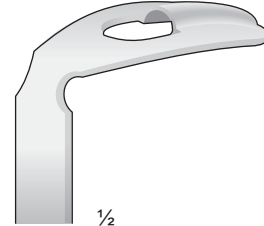

OM-164
37 x 80 mm

Mundsperrer

Mouth gags

Apribocca

Abrebocas

Ecarteur buccal

Sperrer allein
Gag only
Apribocca solo
Apre-boca suelto
Manche et cadreseuls

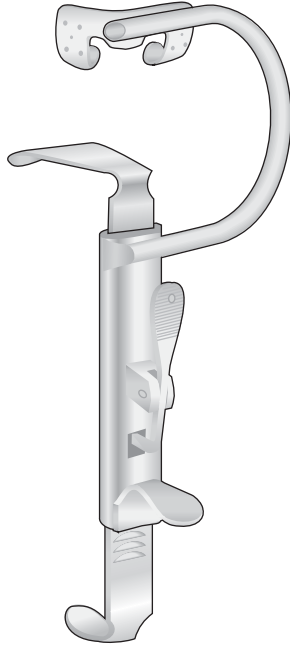

DAVIS-BOYLE
OM-141

DAVIS-BOYLE
OM-140
Komplett mit 5 Zungenspatel
Complete with 5 tongue depressors
Completo con 5 abbassalingua
Completo con 5 abaja lengua
Complet avec 5 abaisse-langues

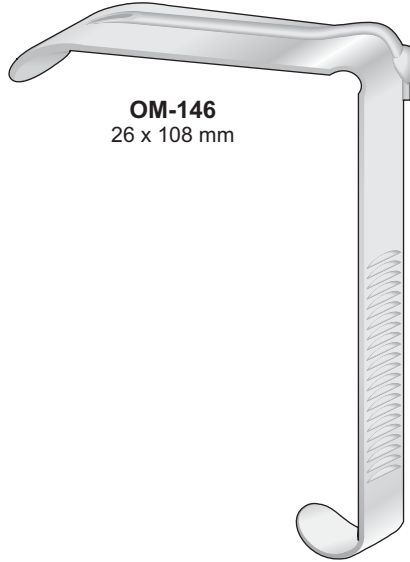

OM-146
26 x 108 mm



OM-145
25 x 93 mm



OM-144
24 x 80 mm



OM-143
23 x 65 mm

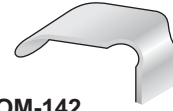

OM-142
21 x 30 mm

Mc-IVOR
OM-170
Komplett mit 3 Zungenspatel
Complete with 3 tongue depressors
Completo di 3 abbassalingua
Completo con 3 abaja lengua
Complet avec 3 abaisse-langues

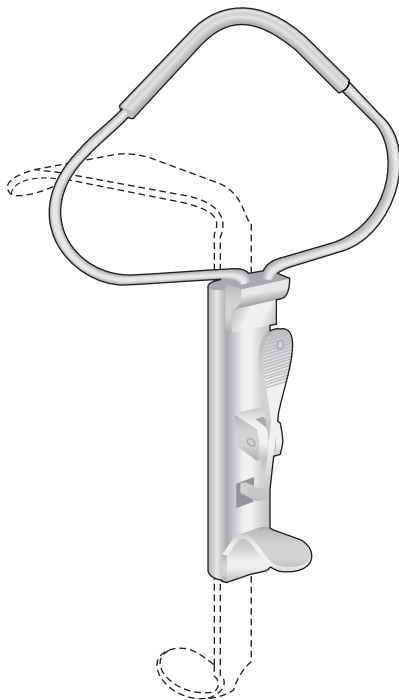

Mc-IVOR
OM-171



OM-174
26 x 100 mm

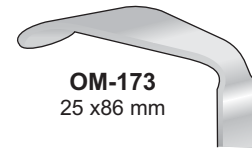

OM-173
25 x 86 mm

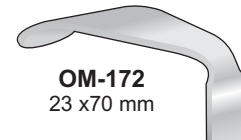

OM-172
23 x 70 mm

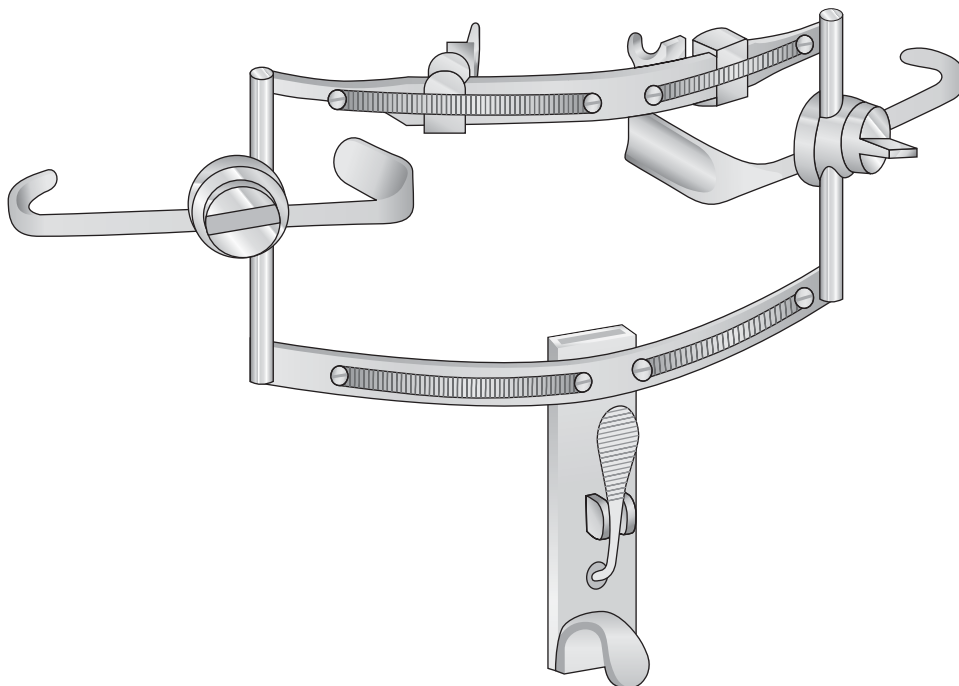

DINGMANN
OM-111

Zungenspatel
Tongue depressor
Abbassalingua
Bajalengua
Abaisse langue

Fig. 1

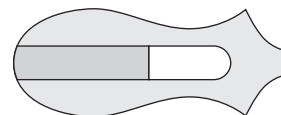

OM-112
65 x 25 mm

Fig. 2

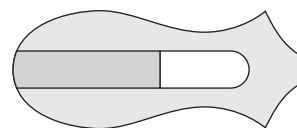

OM-113
70 x 29 mm

Fig. 3

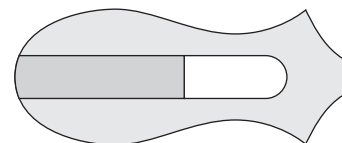

OM-114
80 x 32 mm

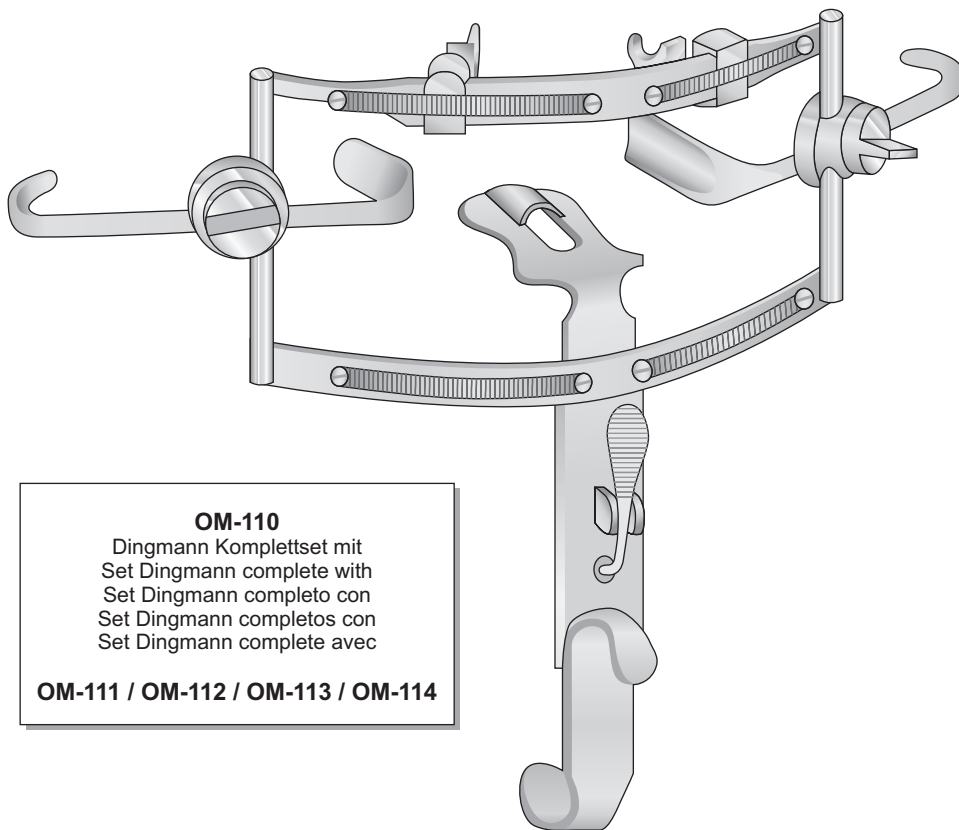

OM-110
Dingmann Komplettsset mit
Set Dingmann complete with
Set Dingmann completo con
Set Dingmann completos con
Set Dingmann complete avec
OM-111 / OM-112 / OM-113 / OM-114

DINGMANN
OM-110
Set completo

Wundhaken

Retractors

Divaricatori

Separadores

Ecarteurs

OM-85
Komplettset mit 3 Spatel
Set complete with 3 spatulas
Set completo con 3 spatole
Set completos con 3 espátulas
Set complete avec 3 spatules
OM-80 + OM-81 + OM-82

Biegsam - Malleable
Malleabile - Maleable - Souple



OM-101 30 mm
OM-102 40 mm
OM-103 50 mm
330 mm

Biegsam - Malleable
Malleabile - Maleable - Souple



40 mm
50 mm
HABERER
OM-104
300 mm

Biegsam - Malleable
Malleabile - Maleable - Souple



17 mm
25 mm
TUFFIER
OM-99
200 mm

Rostfrei - Stainless Steel - Acciaio - Acero - Acer
Biegsam - Malleable - Malleabili - Maleables - Souples



18 mm
22 mm
OM-80
200 mm



14 mm
16 mm
OM-81
200 mm

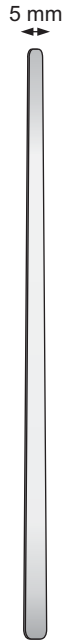

5 mm
8 mm
OM-82
240 mm

Rostfrei - Stainless Steel - Acciaio - Acero - Acer
Biegsam - Malleable - Malleabili - Maleables - Souples



18 mm
22 mm
OM-87
200 mm

Schwarz Verchromt
Black anodized
Cromato nero
Cromado en negro
Chromé noir

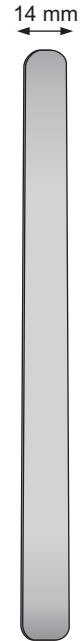

14 mm
16 mm
OM-88
200 mm

Zungendrucker

Tongue depressor

Abbassalingua

Bejalenguas

Abaisse-langues

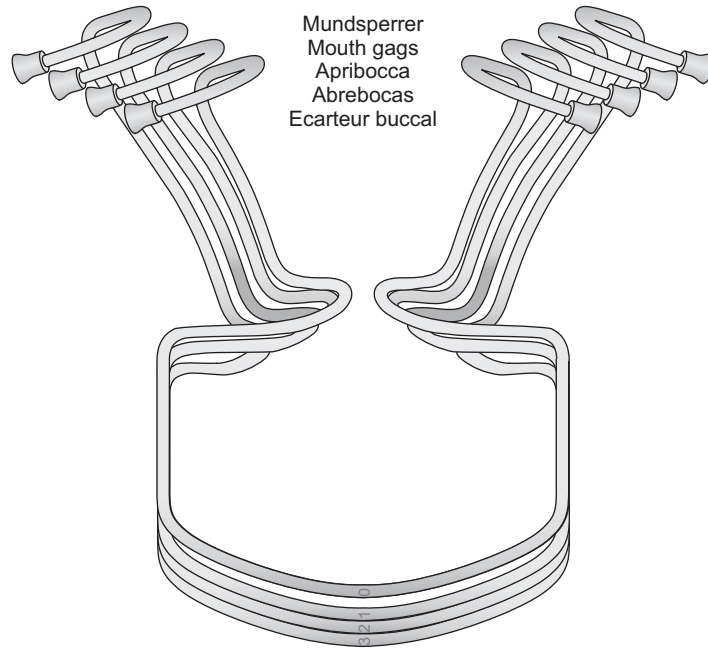

Mundsperrer
Mouth gags
Apribocca
Abrebocas
Ecarteur buccal

ORINGER

- OM-74** Fig. 0 100 x 95 mm Per bambini
- OM-75** Fig. 1 115 x 105 mm Per adulti
- OM-76** Fig. 2 115 x 110 mm Per adulti
- OM-77** Fig. 3 125 x 115 mm Per adulti

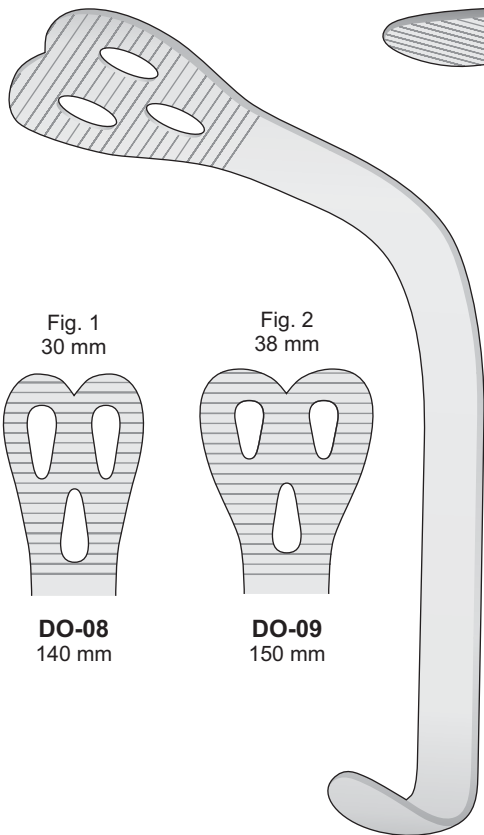
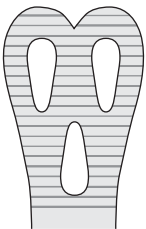
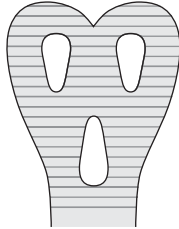

Fig. 1
30 mm



DO-08
140 mm

Fig. 2
38 mm



DO-09
150 mm

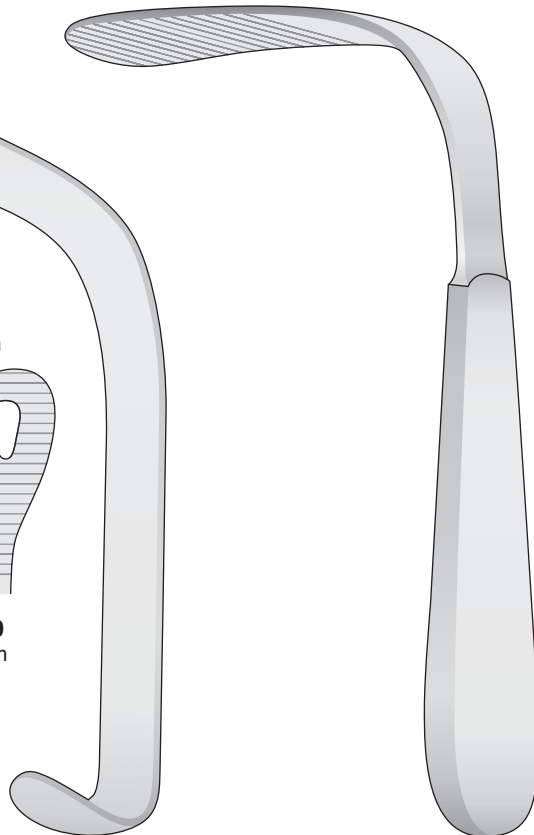

WIEDER
DO-08/DO-09

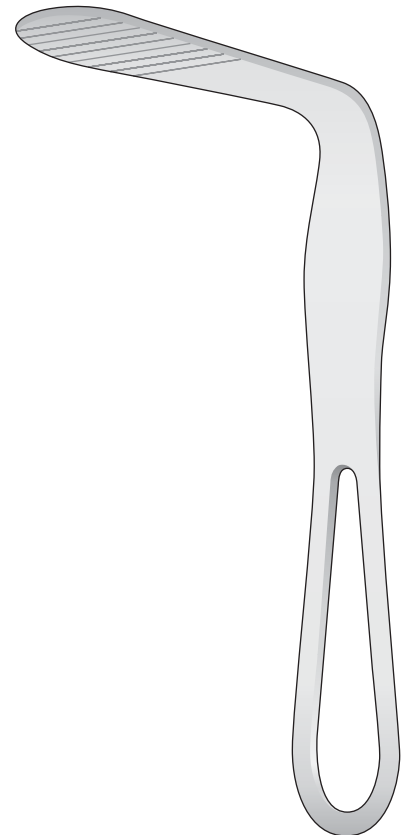

TOBOLD
OM-08
145 mm

HARTMANN
OM-06
150 mm

Wundhaken

Retractors

Divaricatori

Separadores

Ecarteurs

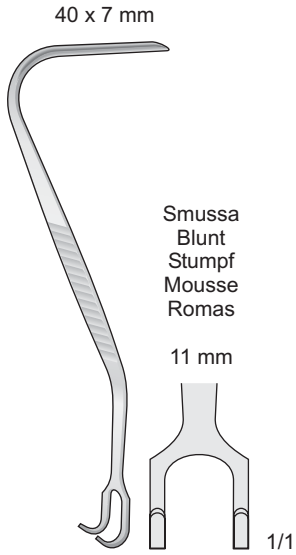

AUFRICHT
BT-381
135 mm

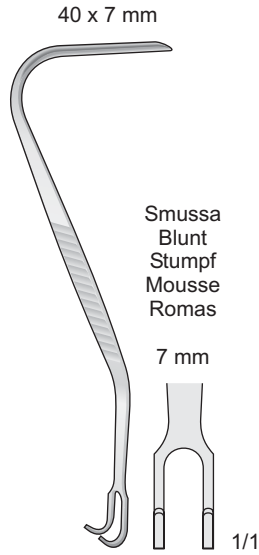

AUFRICHT-WALTER
BT-387
135 mm

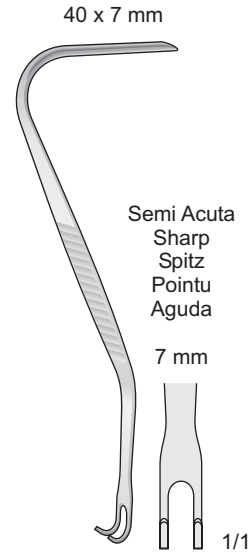

AUFRICHT-WALTER
BT-388
135 mm

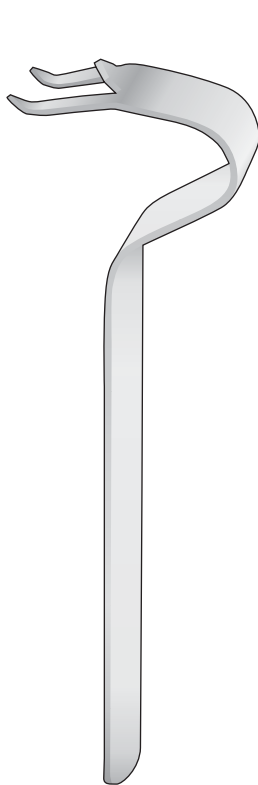

OBWEGESER
DO-40
155 mm

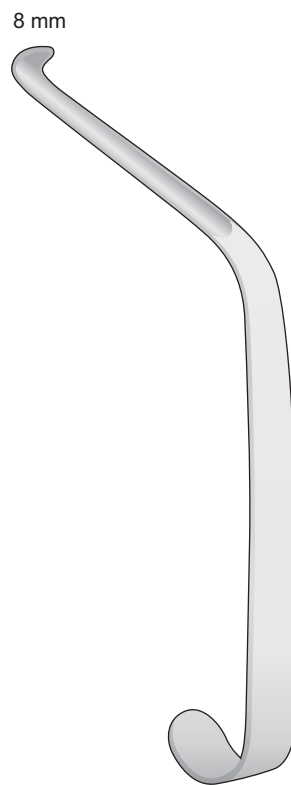

OBWEGESER
DO-41
165 mm

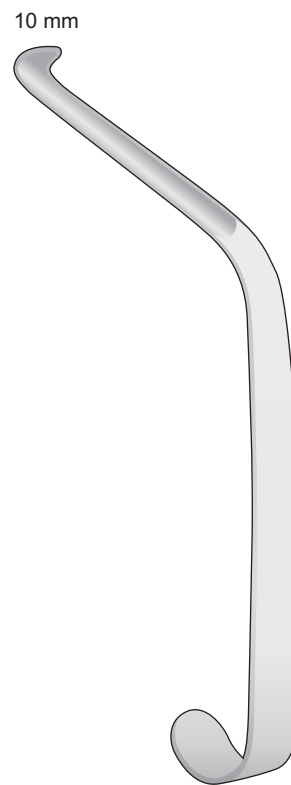

OBWEGESER
DO-142
165 mm

Wundhaken

Retractors

Divaricatori

Separadores

Ecarteurs

Posteriore
Posterior

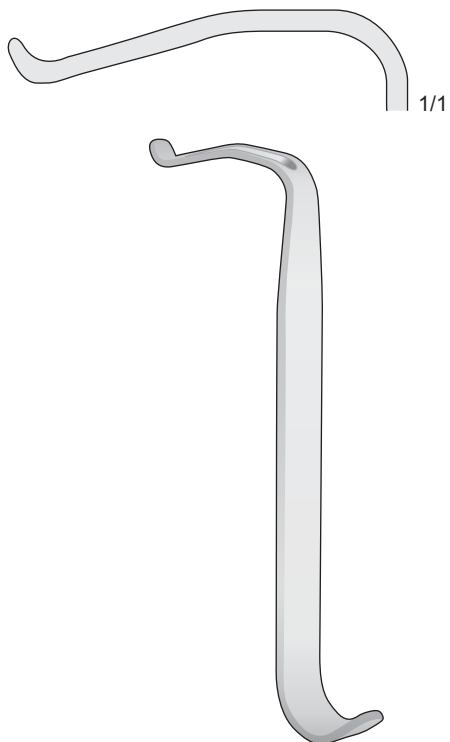

DUNN-DAUTREY
DO-94 6,5 x 50 mm
140 mm

Anterior
Anteriore

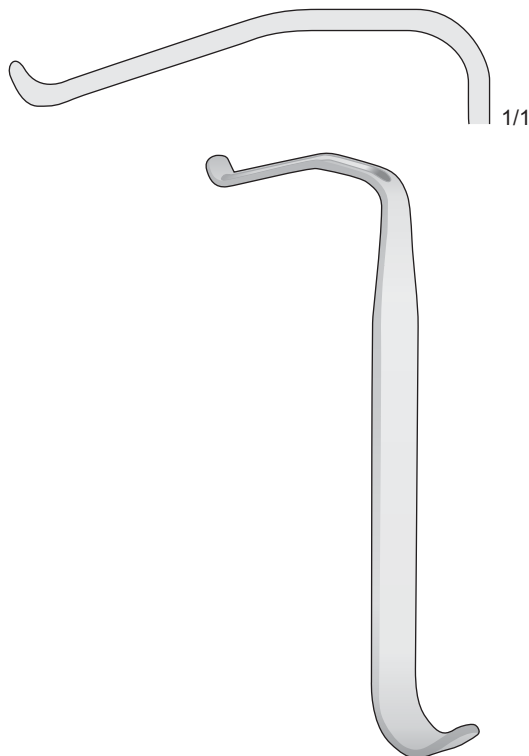

DUNN-DAUTREY
DO-95 6,5 x 60 mm
140 mm

Superior
Superiore

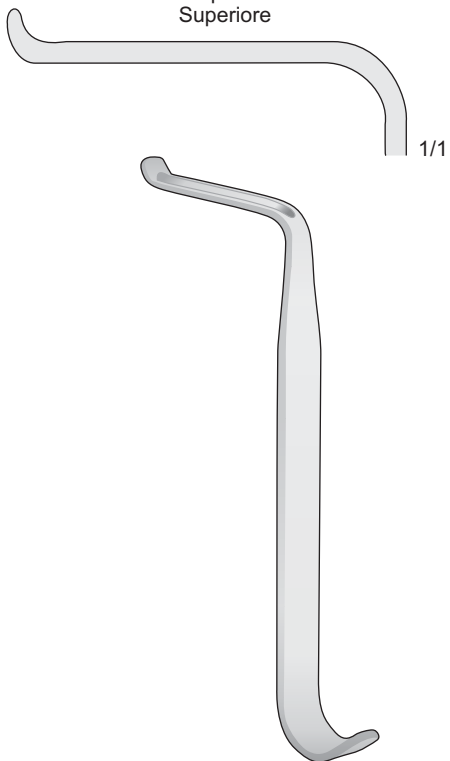

DUNN-DAUTREY
DO-96 8 x 50 mm
140 mm

Superior
Superiore

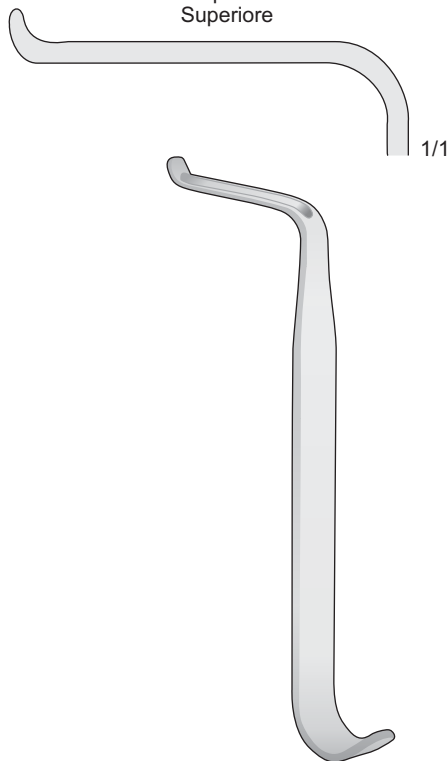

DUNN-DAUTREY
DO-97 6,5 x 50 mm
140 mm

Wundhaken

Retractors

Divaricatori

Separadores

Ecarteurs

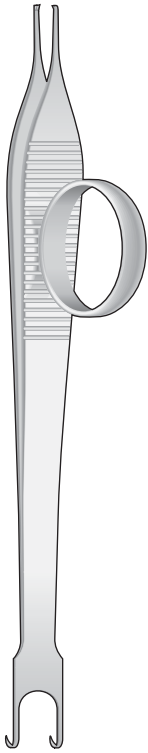

MILLARD
BD-342/BD-343
150 mm

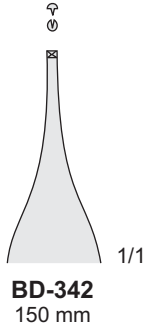

BD-342
150 mm

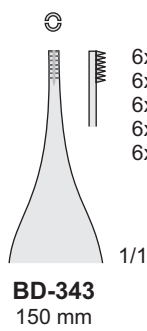

BD-343
150 mm

6x6 Zähne
6x6 Teeth
6x6 Denti
6x6 Dientes
6x6 Dents

Fingerring Häkchen
Finger ring Retractor
Uncino nasale a forma di anello
Ganchito en forma de anillo
Crochet nasal en forme de bague

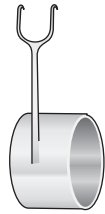

COTTLE
DO-259

Knorpelquetsche
Cartilage crusher
Strumento per cartilagine
Machacadora
Pincas-Gouge à cartilage

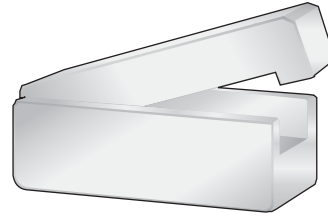

COTTLE
DO-264

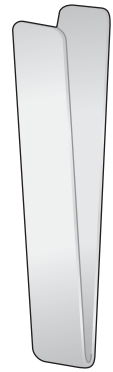

Nasenflügelhäkchen
Alar Retractor
Uncino per alette nasali
Ganchos para las alas de la nariz
Crochet pour les ailes du nez

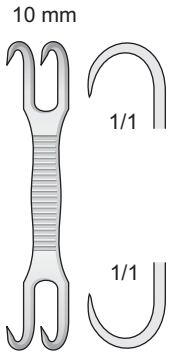

BT-226
63 mm

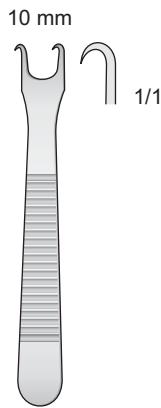

KILNER
BT-273
80 mm

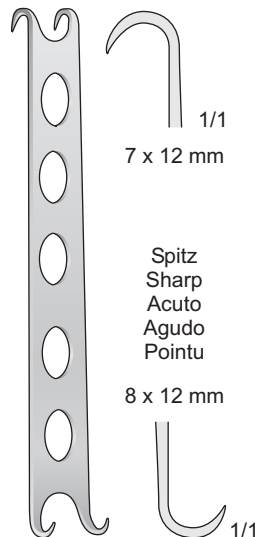

CONVERSE
BT-22
120 mm

Spitz
Sharp
Acuto
Agudo
Pointu

7 x 12 mm

Spitz
Sharp
Acuto
Agudo
Pointu

8 x 12 mm



COTTLE
BT-196
160 mm



COTTLE
BT-197/BT-199
150 mm

Fig. 1 1/1
Fig. 2 1/1
Fig. 3 1/1
BT-197 BT-198 BT-199

Mikro Wundhaken

Micro Retractors

Micro divaricatori

Micro Separadores

Micro Ecarteurs

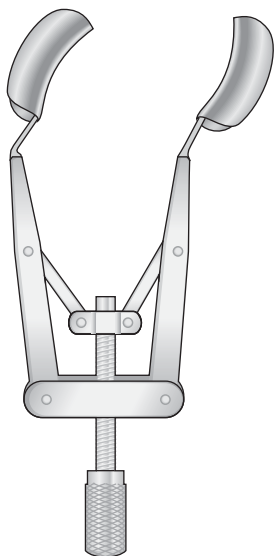

KERSHNER
NK-420

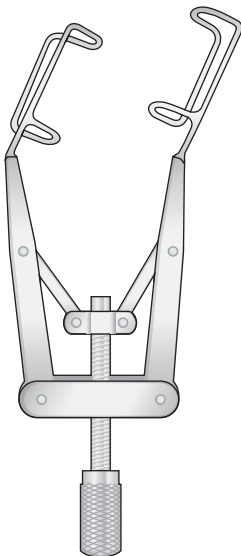

KERSHNER
NK-421

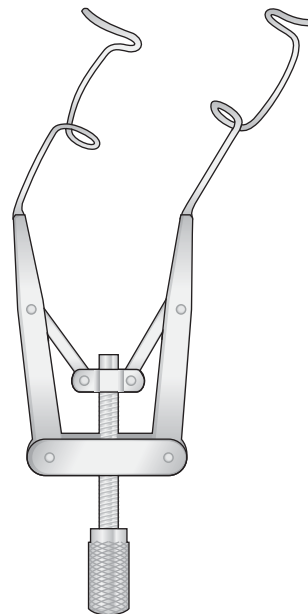

LIEBERMANN-TENNANT
NK-422

Uncini cutanei - Cutaneous hook - Hauthäkchen - Erignes cutanées - Ganchos cutâneos

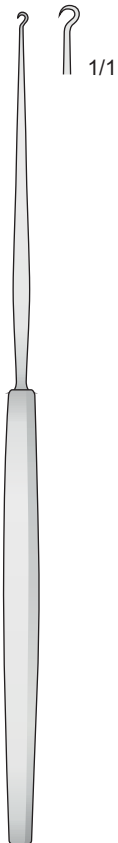

GILLIES
BT-15
180 mm

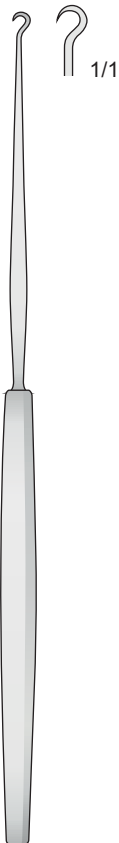

GILLIES
BT-16
180 mm

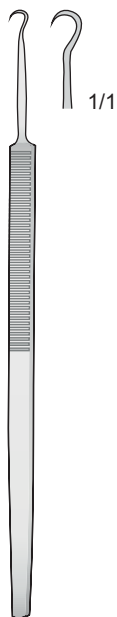

BT-207
120 mm

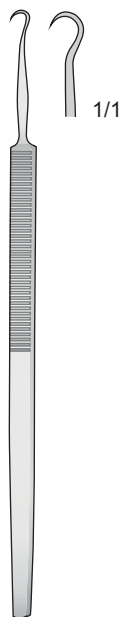

BT-208
120 mm

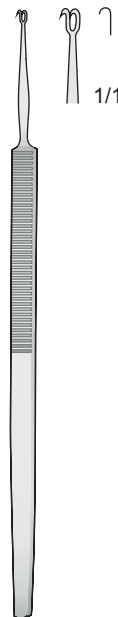

GUTHRIE
BT-203
120 mm

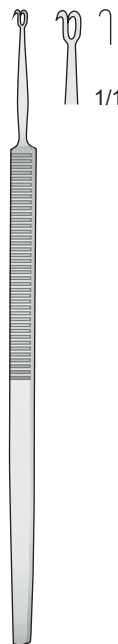

GUTHRIE
BT-204
130 mm

Wundhaken

Retractors

Divaricatori

Separadores

Ecarteurs

Sperrelevatoren - Eye specula - Blefarostati
Blefarostatos - Blèpharostats

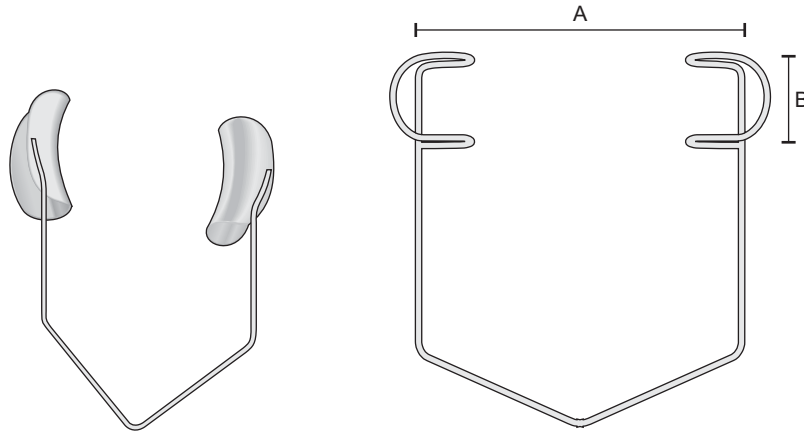

BARRAQUER
NK-83

	A	B
NK-80	27 mm	5 mm
NK-82	34 mm	9 mm
NK-84	42 mm	12 mm
NK-86	42 mm	14 mm

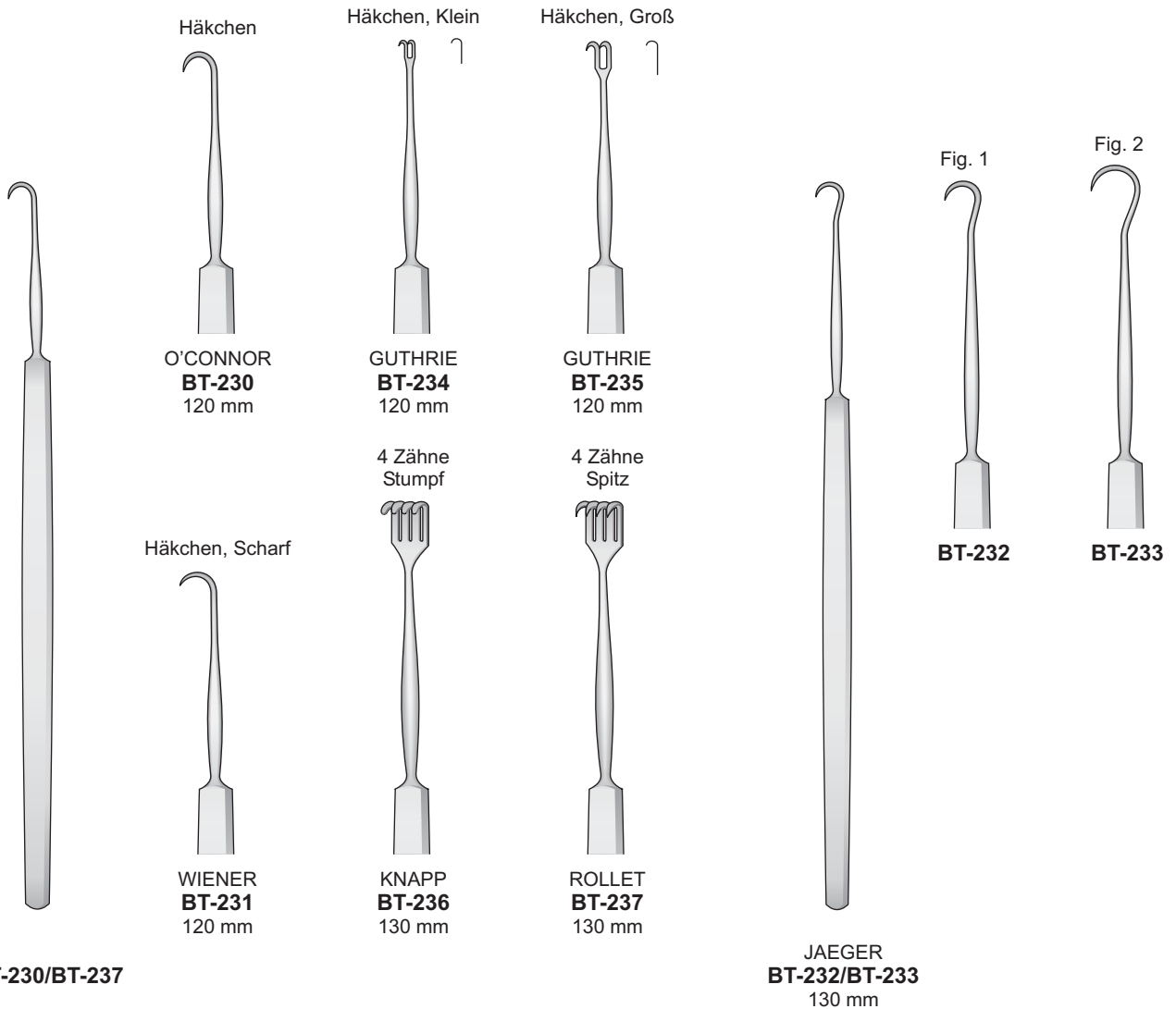

BT-230/BT-237

JAEGER
BT-232/BT-233
130 mm

Wundhaken

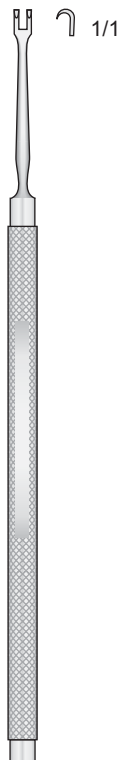

**KIRBY
BT-243**
130 mm

Retractors

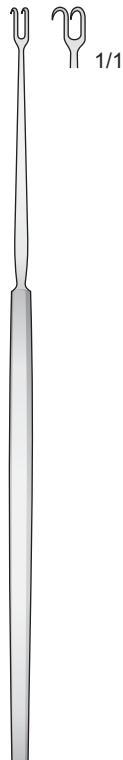

**FREER
BT-200**
150 mm

Divaricatori

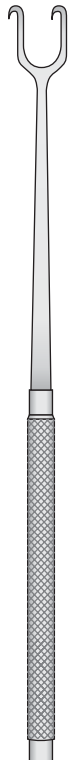

**JOSEPH
BT-210/BT-214**
160 mm

Separadores

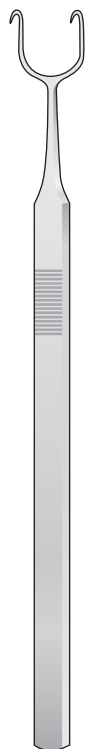
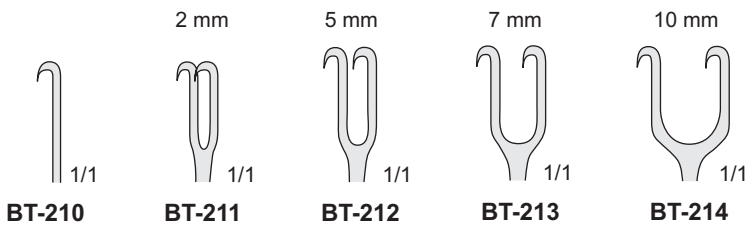

**COTTLE
BT-215/BT-217**
150 mm

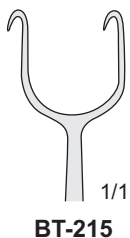

BT-215

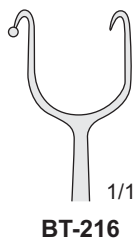

BT-216

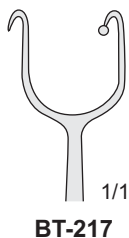

BT-217

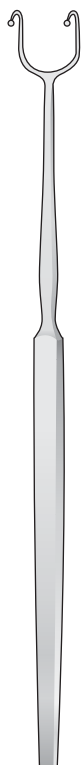

**FOMON
BT-218**
160 mm

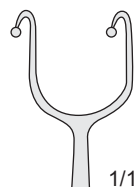

1/1



**COTTLE-NEIVERT
BT-57**
200 mm

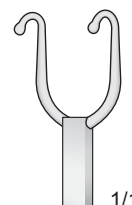

1/1

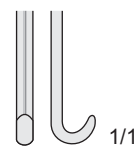

1/1

Wundhaken

Retractors

Divaricatori

Separadores

Ecarteurs

2 Zähne



3 Zähne



Häkchen



AXENFELD
BT-238 Scharf
BT-239 Stumpf

AXENFELD
BT-240 Scharf
BT-241 Stumpf

PAUL
BT-242

Feine Wundhaken flexibel-spitz - Delicate retractors flexible-sharp
Divaricatori delicati flessibili-acuti - Separadores finos flexibles-agudas

Feine Wundhaken flexibel-stumpf - Delicate retractors flexible-blunt
Divaricatori delicati flessibili-smussi - Separadores finos flexibles-romas

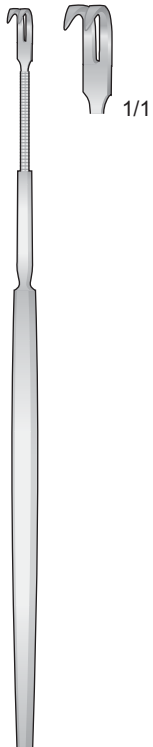

BT-50
150 mm

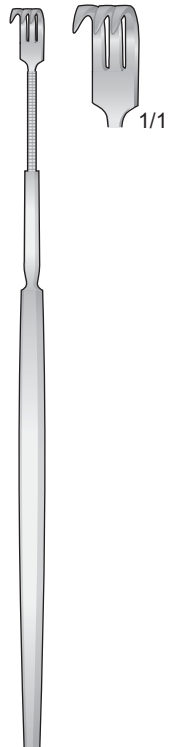

BT-51
150 mm

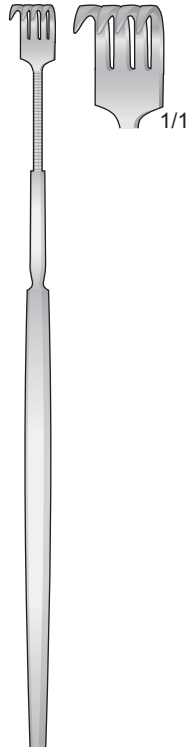

BT-52
150 mm

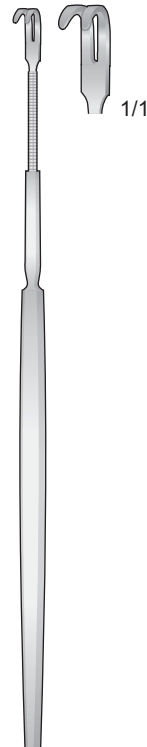

BT-54
150 mm

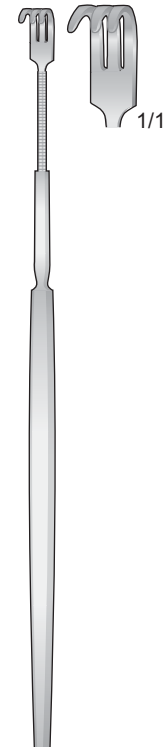

BT-55
150 mm

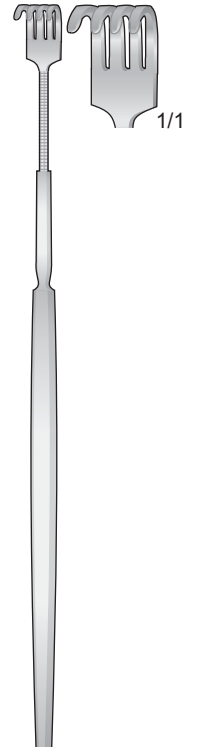

BT-56
150 mm

Wundhaken

Retractors

Divaricatori

Separadores

Ecarteurs

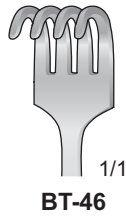
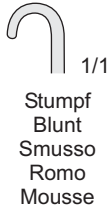
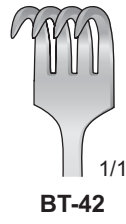
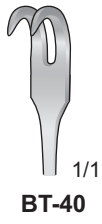
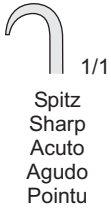
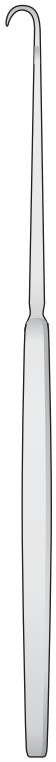

Instrumente zur Nasenplastik
Instrument for Rhinoplastic

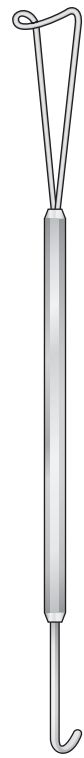
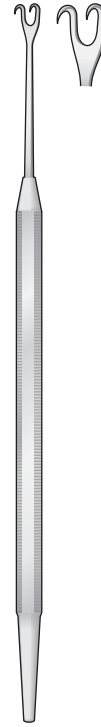

BT-40/BT-46
160 mm

COTTLE
BT-382
150 mm

NEIVERT
BT-383
160 mm

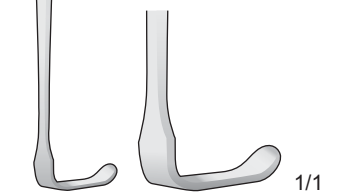
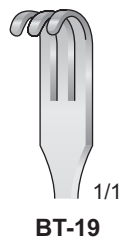
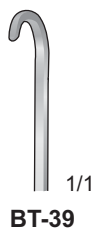
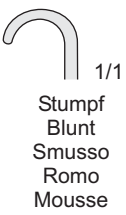
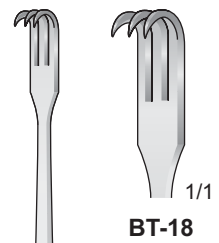
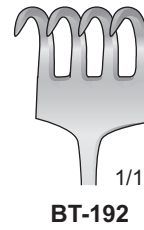
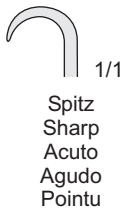

BT-38/BT-195
160 mm

SENN-MILLER
BT-18/BT-19
160 mm

Wundhaken

Retractors

Divaricatori

Separadores

Ecarteurs

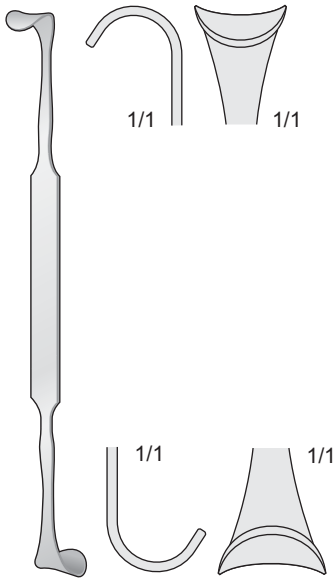

ROSE
DS-15
130 mm

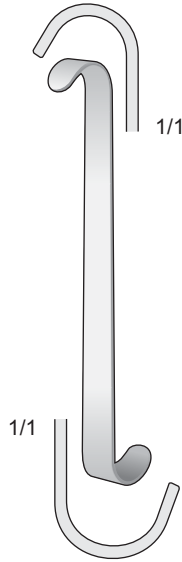

LUER
DS-16
110 mm

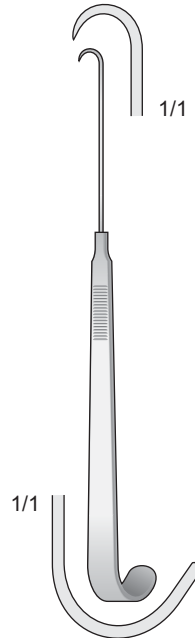

NEWS
DS-19
150 mm

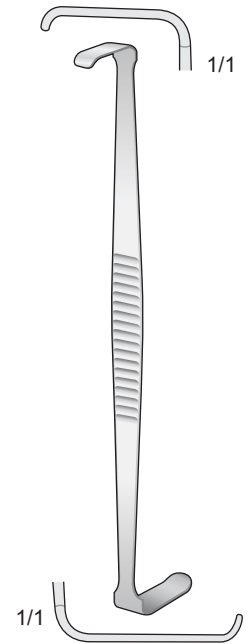

HOUSE
DS-20
150 mm

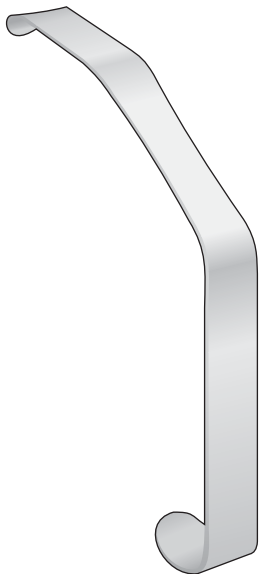

LOVE
DO-213/DO-215
150 mm

DO-213 - 18 mm
DO-214 - 20 mm
DO-215 - 22 mm



CUSHING
BT-296/BT-297
190 mm

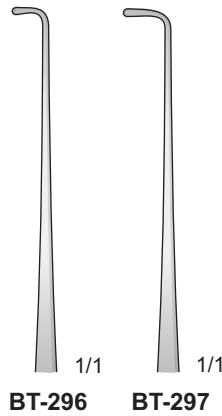

BT-296 1/1
BT-297 1/1



CUSHING
BT-298/BT-299
280 mm

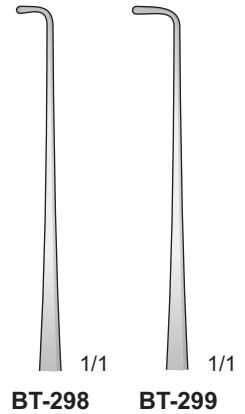

BT-298 1/1
BT-299 1/1

Wundhaken

Retractors

Divaricatori

Separadores

Ecarteurs

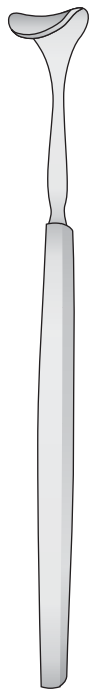

DESMARRES
BT-70/BT-79
140 mm



BT-70
10 mm



BT-72
14 mm



BT-74
16 mm

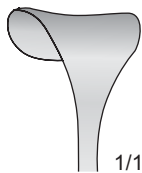

BT-77
18 mm



BT-71
12 mm



BT-73
14 mm



BT-75
16 mm

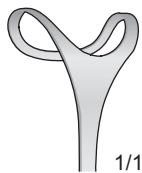

BT-79
18 mm

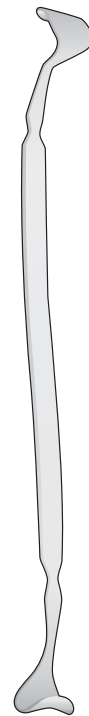

ROSTKOWSKI
BT-76
135 mm



Lidhalter Gr. 2

KIRBY
BT-244
140 mm

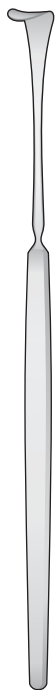

CONWAY
NK-144
140 mm



DESMARRES
NK-145
140 mm

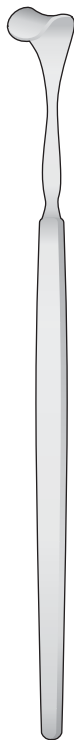

COTTLE
BT-245
150 mm

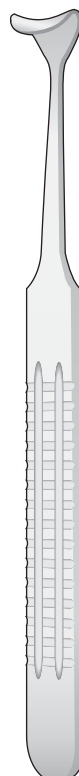

DESMARRES
BT-28
160 mm

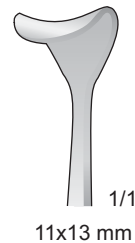

1/1
11x13 mm

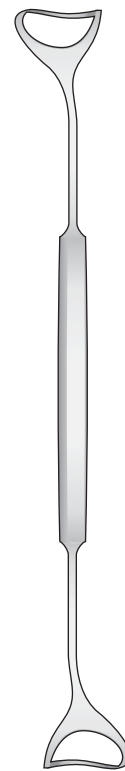

KLAR EVATEUR
BT-09
160 mm

Wundhaken

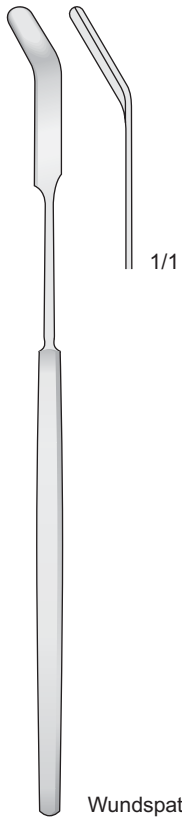

1/1

Wundspatel

GIESSEN
NK-251

Retractors

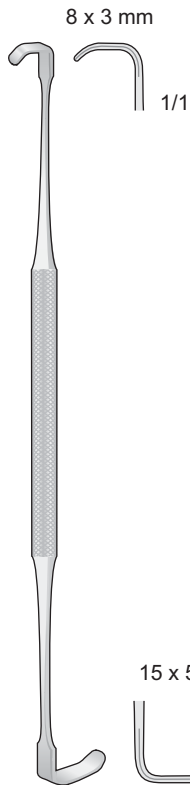

8 x 3 mm

1/1

15 x 5 mm

1/1

RAGNELL
BT-27
140 mm

Divaricatori

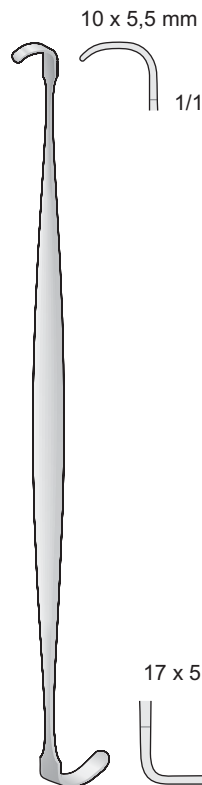

10 x 5,5 mm

1/1

17 x 5,5 mm

1/1

RAGNELL-DAVIS
BT-26
140 mm

Separadores



1/1

BT-48
10 x 6 mm

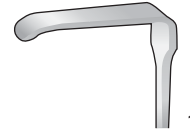

1/1

BT-49
20 x 6 mm

SENN-GREEN
BT-48/BT-49
160 mm

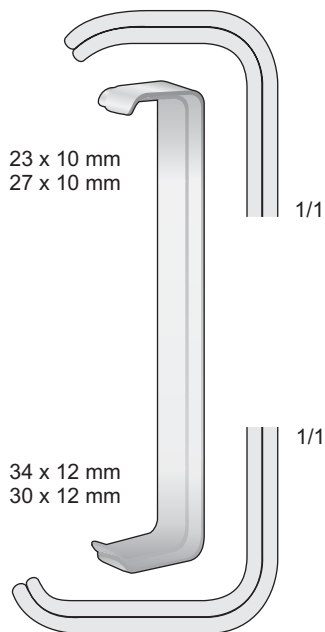

23 x 10 mm
27 x 10 mm

1/1

34 x 12 mm
30 x 12 mm

1/1

FARABEUF
BT-20
120 mm

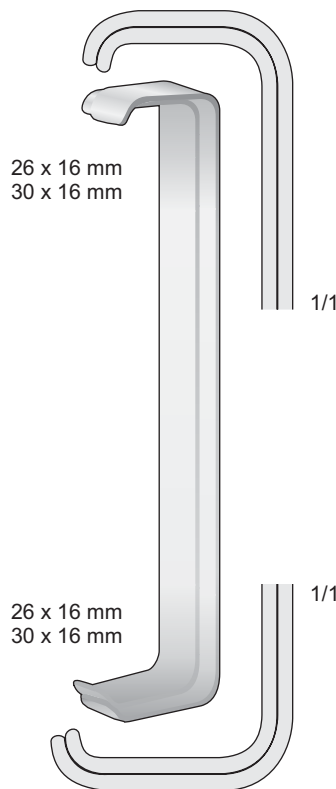

26 x 16 mm
30 x 16 mm

1/1

26 x 16 mm
30 x 16 mm

1/1

FARABEUF
BT-25
150 mm

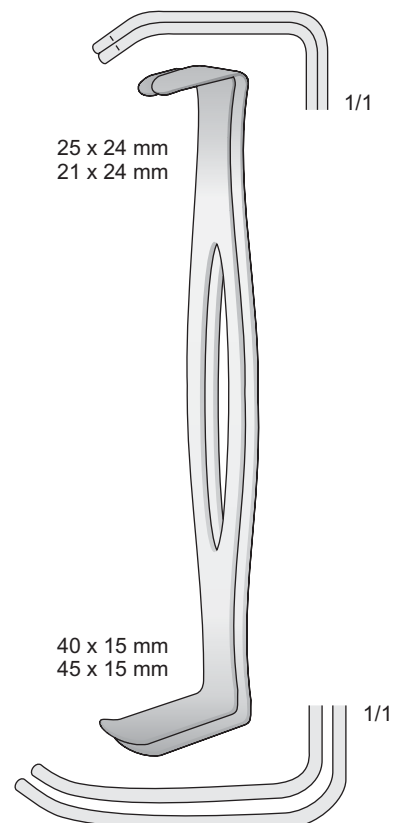

25 x 24 mm
21 x 24 mm

1/1

40 x 15 mm
45 x 15 mm

1/1

PARKER-LANGENBECK
BT-291
210 mm

Wundhaken

Retractors

Divaricatori

Separadores

Ecarteurs

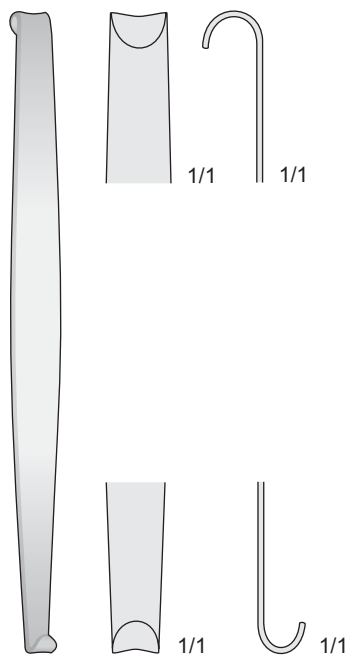

MINI-ROUX
BT-282
150 mm

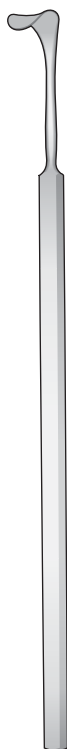

CUSHING
BT-401/BT-406
200 mm



BT-283
Komplettset
Set complete
Set completo
Set completo
Set complet

29 mm
26 mm
22 mm

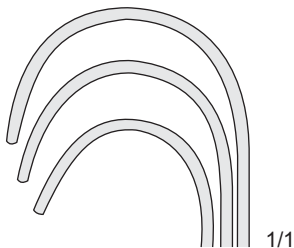

BT-284 - 20x22 mm
25x28 mm
BT-285 - 23x26 mm
29x38 mm
BT-286 - 29x29 mm
34x44 mm

28 mm
38 mm
44 mm

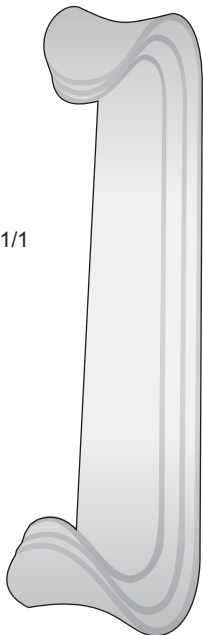

ROUX
BT-284/BT-286
165 mm

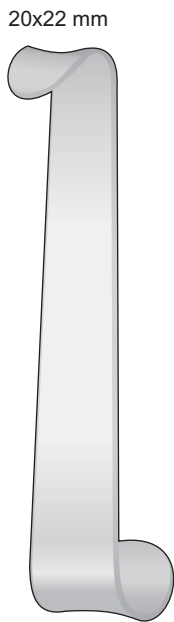

25x28 mm
ROUX-MAGNUS
BT-287
150 mm

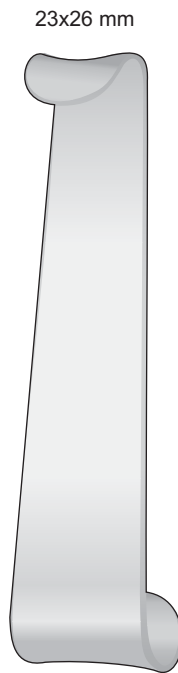

29x38 mm
ROUX-MAGNUS
BT-288
160 mm

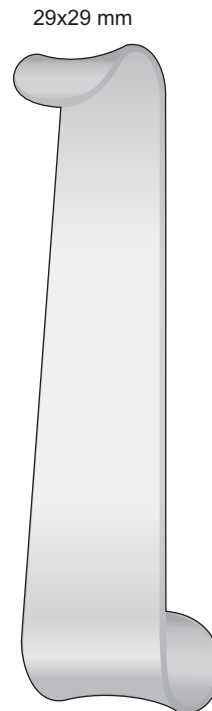

34x44 mm
ROUX-MAGNUS
BT-289
170 mm

Wundhaken

Retractors

Divaricatori

Separadores

Ecarteurs

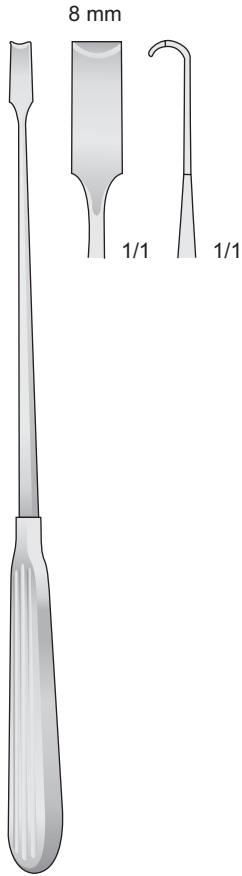

SCOVILLE
BT-312
230 mm

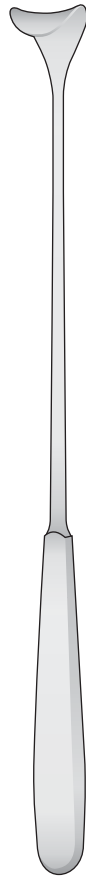

CUSHING
BT-114/BT-116
250 mm

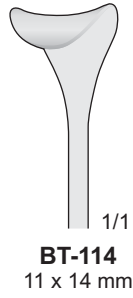

BT-114
11 x 14 mm

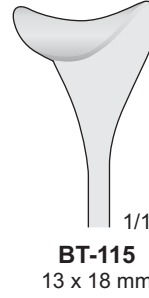

BT-115
13 x 18 mm

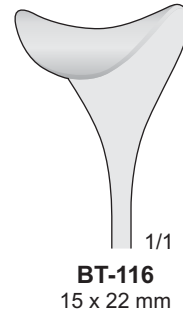

BT-116
15 x 22 mm

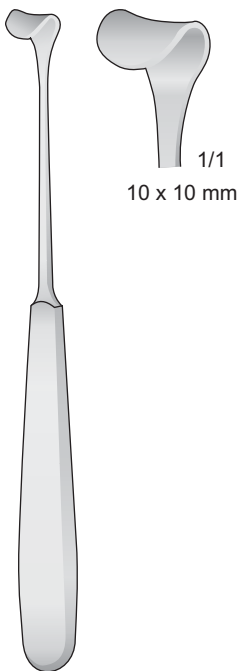

CUSHING-KOCHER
BT-113
180 mm



KOCHER
BT-117/BT-118
205 mm

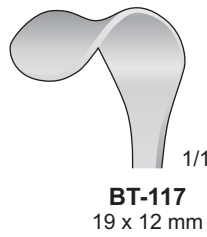

BT-117
19 x 12 mm

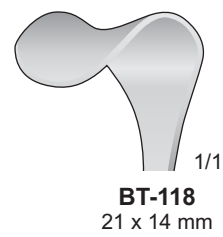

BT-118
21 x 14 mm

Wundhaken

Retractors

Divaricatori

Separadores

Ecarteurs

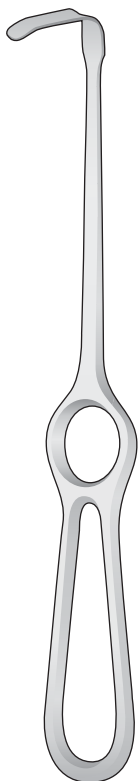

OBWEGESER
BT-152/BT-157
220 mm

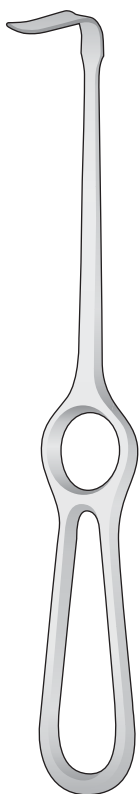

OBWEGESER
BT-92/BT-100
220 mm

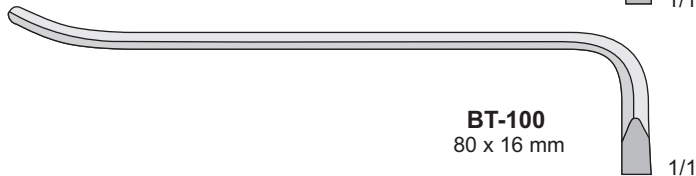
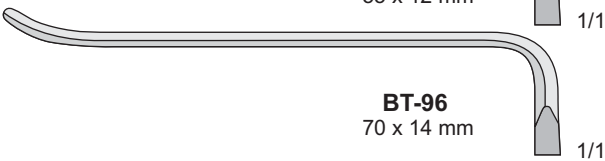
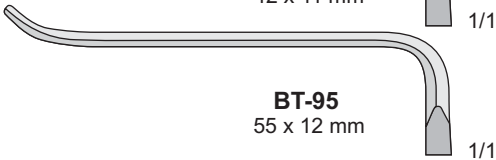
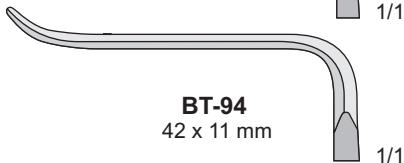
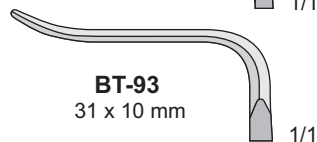
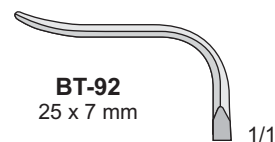
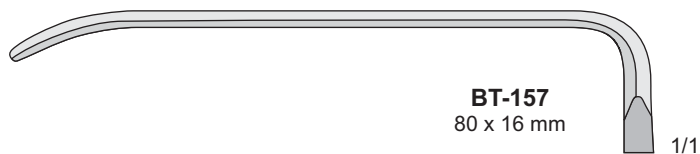
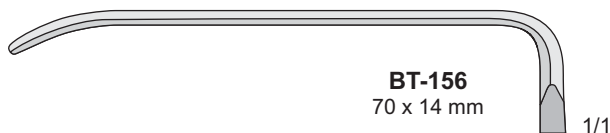
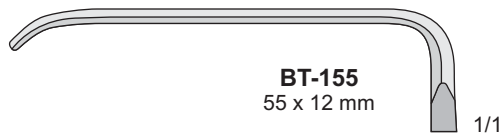
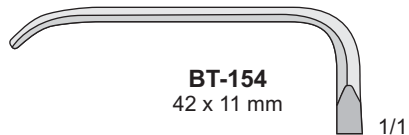
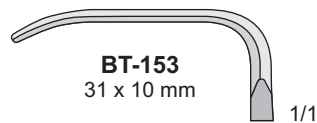

Wundhaken

Retractors

Divaricatori

Separadores

Ecarteurs

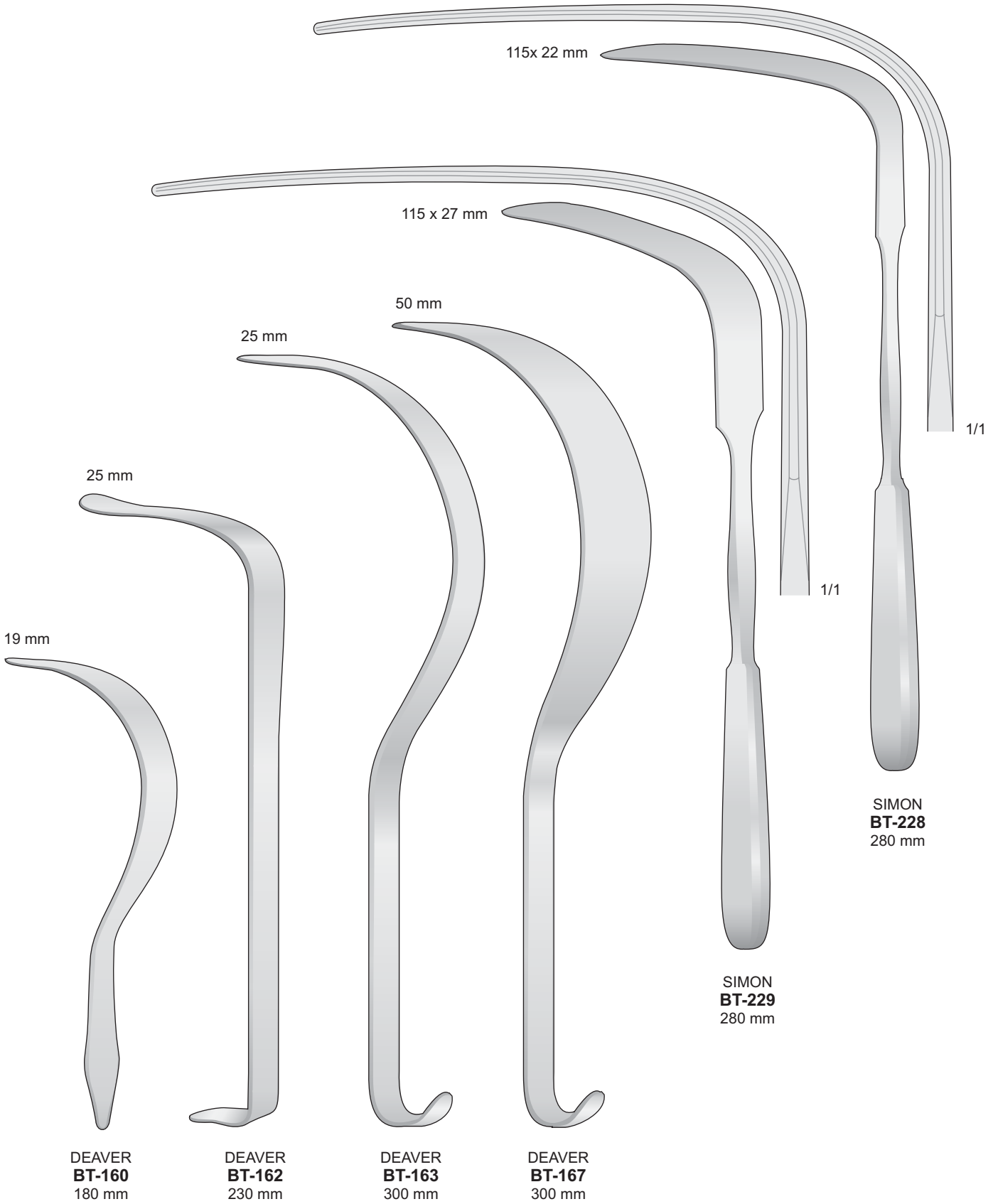

Wundhaken

Retractors

Divaricatori

Separadores

Ecarteurs

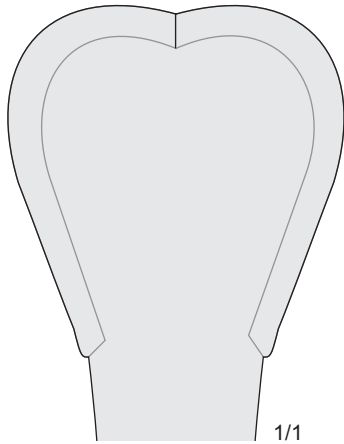

BT-341 - 127 x 40 mm

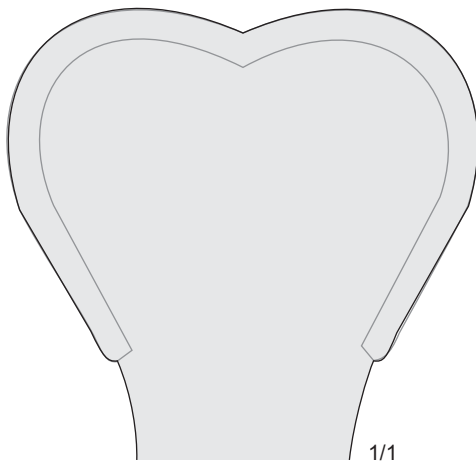

BT-342 - 127 x 62 mm

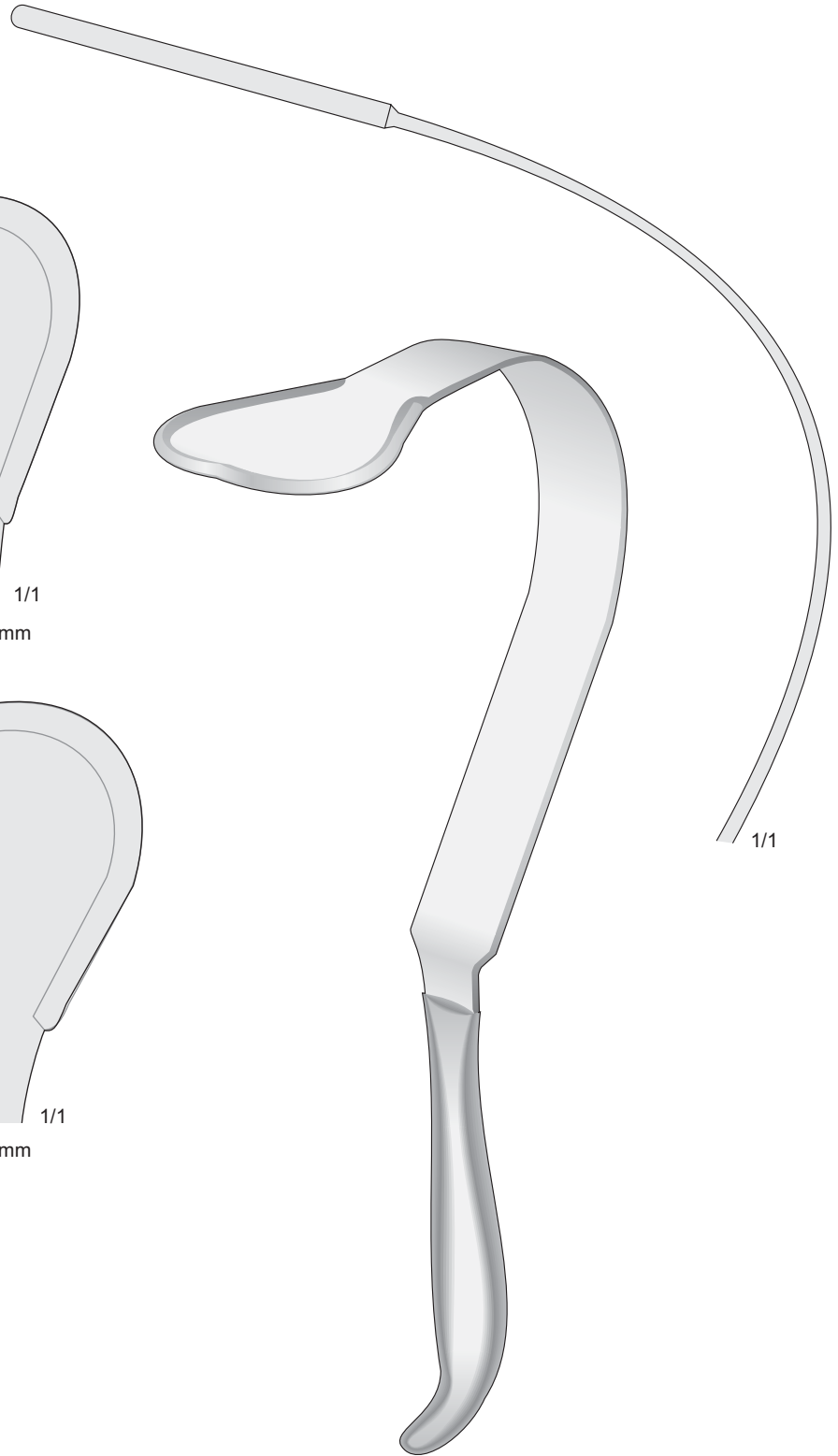

HARRINGTON
BT-341/BT-342
320 mm

Wundhaken

Retractors

Divaricatori

Separadores

Ecarteurs

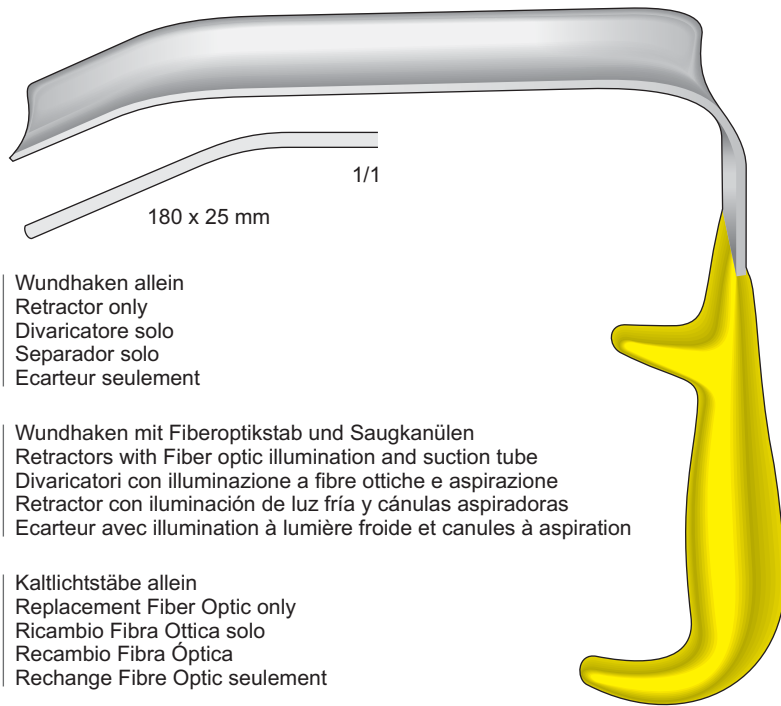

BT-500 | Wundhaken allein
Retractor only
Divaricatore solo
Separador solo
Ecarteur seulement

BT-501 | Wundhaken mit Fiberoptikstab und Saugkanülen
BT-502 | Retractors with Fiber optic illumination and suction tube
Divaricatori con illuminazione a fibre ottiche e aspirazione
Retractor con iluminación de luz fría y cánulas aspiradoras
Ecarteur avec illumination à lumière froide et canules à aspiration

BT-501R | Kaltlichtstäbe allein
BT-502R | Replacement Fiber Optic only
Ricambio Fibra Ottica solo
Recambio Fibra Óptica
Rechange Fibre Optic seulement

BT-500

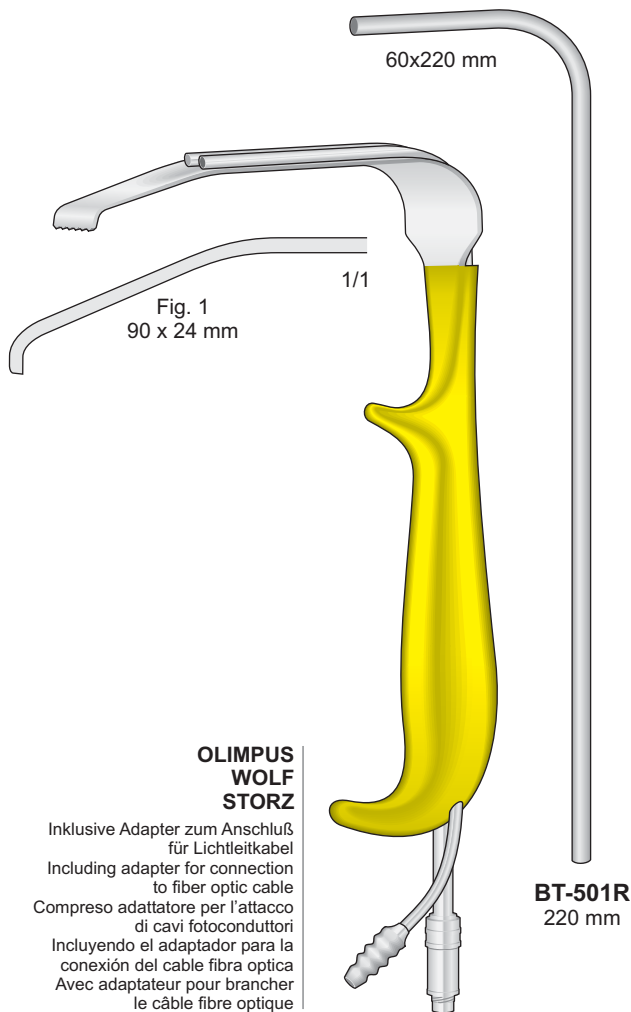

Fig. 1
90 x 24 mm

**OLIMPUS
WOLF
STORZ**

Inklusive Adapter zum Anschluß
für Lichtleitkabel
Including adapter for connection
to fiber optic cable
Compreso adattatore per l'attacco
di cavi fotoconduttori
Incluyendo el adaptador para la
conexión del cable fibra optica
Avec adaptateur pour brancher
le câble fibre optique

BT-501R
220 mm

BT-501

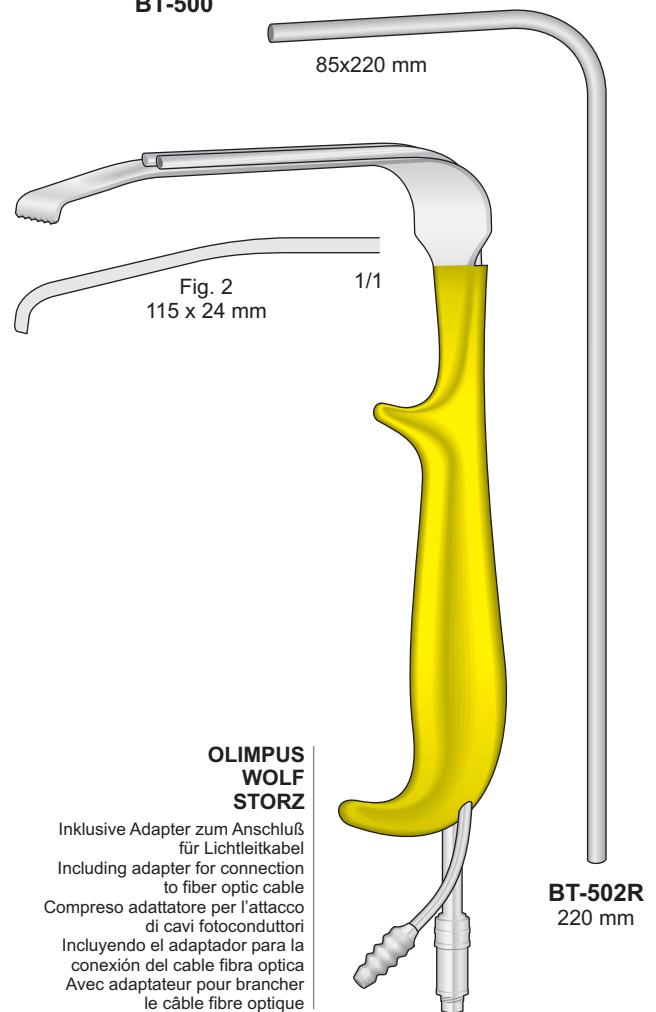

Fig. 2
115 x 24 mm

**OLIMPUS
WOLF
STORZ**

Inklusive Adapter zum Anschluß
für Lichtleitkabel
Including adapter for connection
to fiber optic cable
Compreso adattatore per l'attacco
di cavi fotoconduttori
Incluyendo el adaptador para la
conexión del cable fibra optica
Avec adaptateur pour brancher
le câble fibre optique

BT-502R
220 mm

BT-502

Wundhaken

Retractors

Divaricatori

Separadores

Ecarteurs

BT-503 | Wundhaken mit Fiberoptikstab und Saugkanülen
BT-504 | Retractors with Fiber optic illumination and suction tube
 Divaricatori con illuminazione a fibre ottiche e aspirazione
 Retractor con iluminación de luz fría y cánulas aspiradoras
 Ecarteur avec illumination à lumière froide et canules à aspiration

BT-503R | Kaltlichtstäbe allein
BT-504R | Replacement Fiber Optic only
 Ricambio Fibra Ottica solo
 Recambio Fibra Óptica
 Rechange Fibre Optic seulement

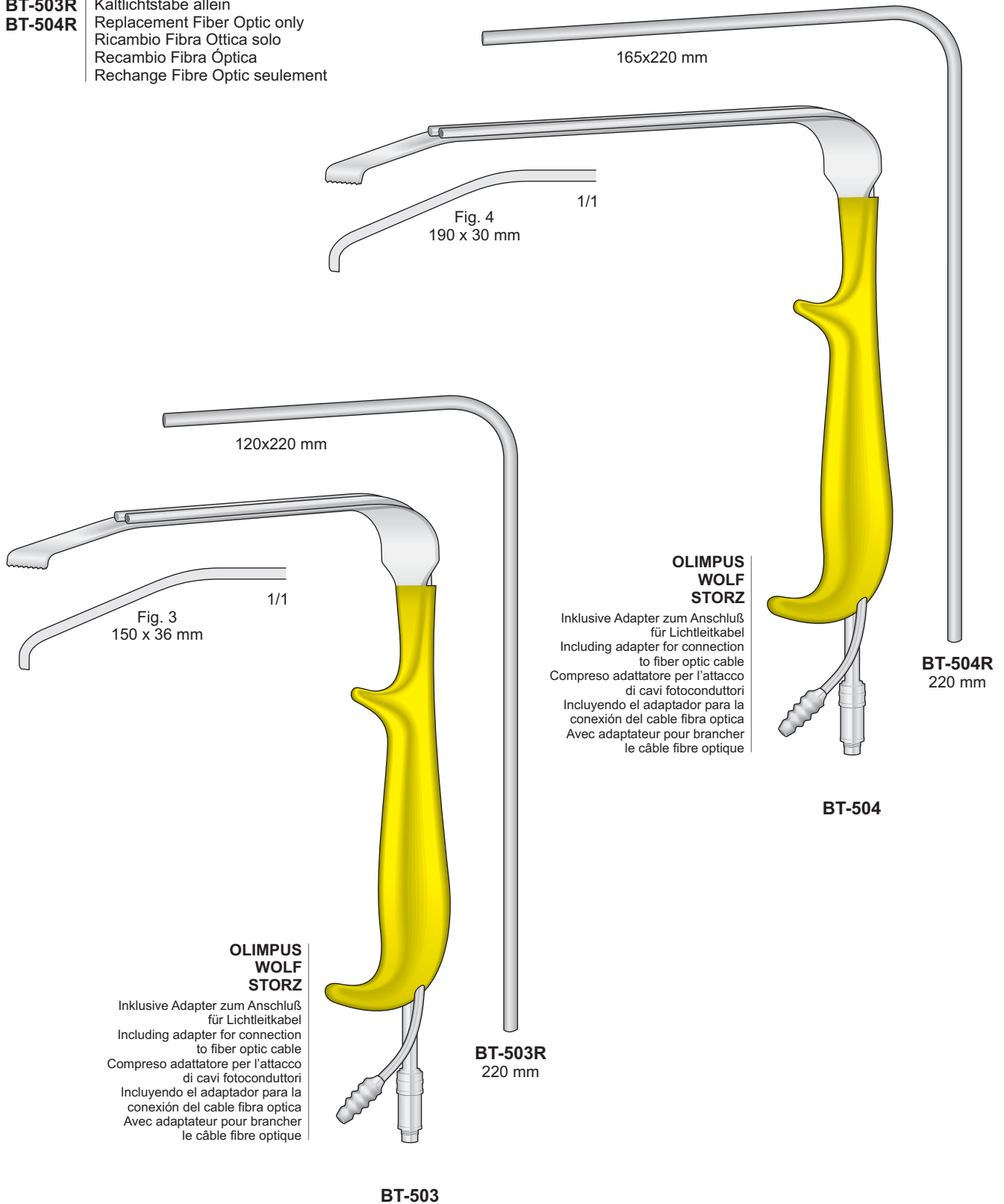

Wundhaken
Dissektoren

Retractors
Dissectors

Divaricatori
Dissettori

Separadores
Disecadores

Ecarteurs
Dissecteurs

Brust Spatel, halb-biegsam
150 mm Langes Blatt
25 mm breit
Breast Spatula, semi-malleable
150 mm blade

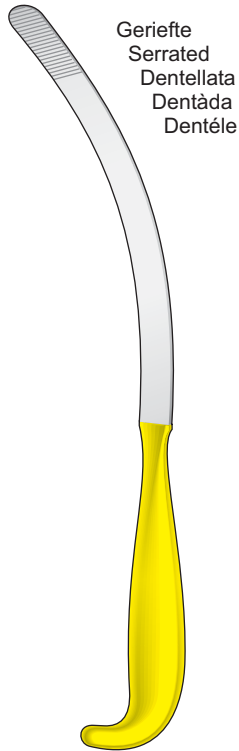

Geriefte
Serrated
Dentellata
Dentada
Dentéle

ES-143
315 mm

Doppelendiger
Brustretractor
Double ended
Breast Retractor

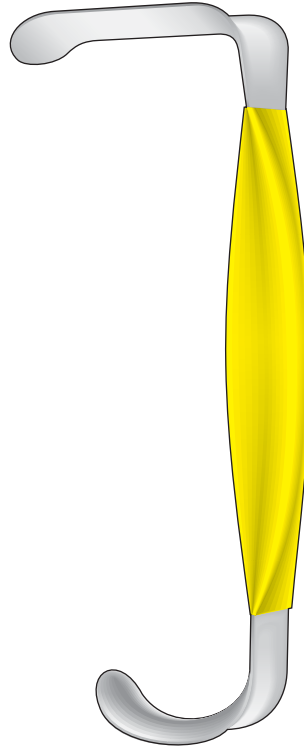

ES-145
310 mm

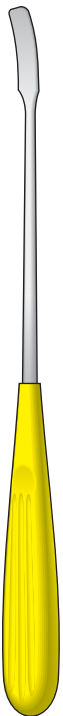

Fig. 1
Leicht gebogen
Slight curved
Curva leggera

ES-131
240 mm

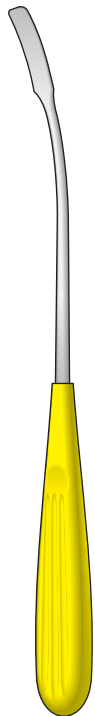

Fig. 2
Medium gebogen
Half curved
Curva media

ES-132
240 mm

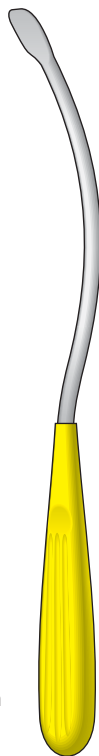

Fig. 3
Gebogen
Curved
Curvo

ES-133
265 mm



Fig. 4
Gerade
Straight
Dritto

ES-134
250 mm

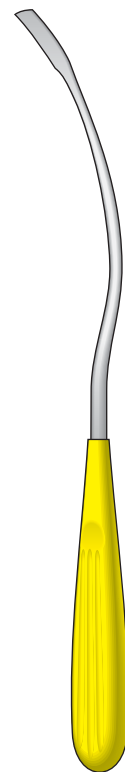

Fig. 5
S-Form
S-shaped
Forma a S

ES-135
280 mm

Dissektoren

Dissectors

Dissettori

Disecadores

Dissecteurs

Breast

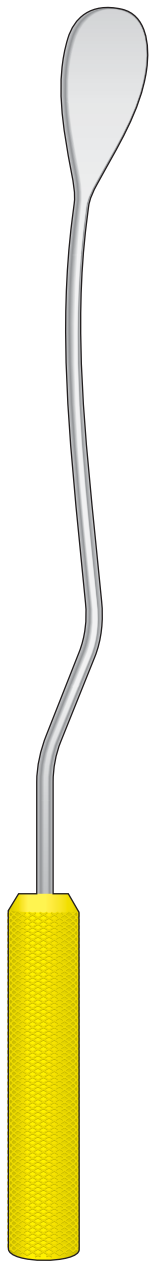

MacCOLLUM-DINGMAN
ES-140
410 mm

Spatulated Ovale Breast

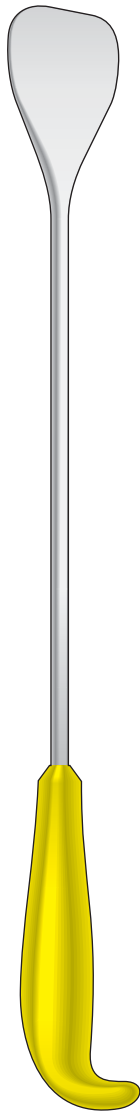

ES-141
330 mm

Angulated Breast



ES-142
330 mm

12 mm

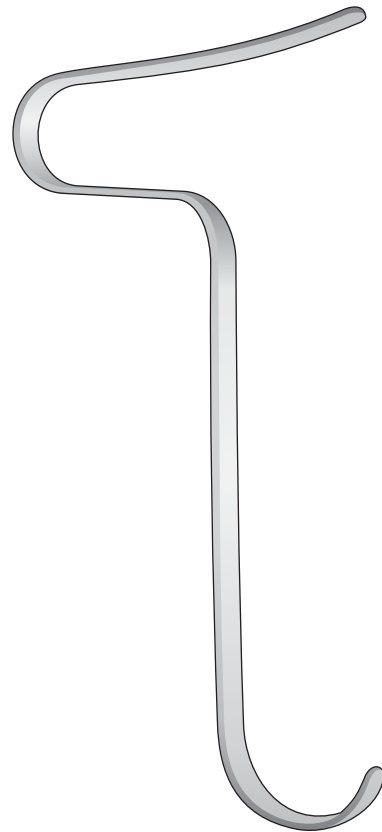

FREEMAN
ES-160
205 mm

8 mm

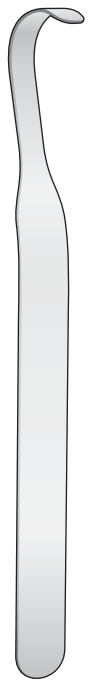

SHEEN
ES-162
150 mm

Wundhaken

Retractors

Divaricatori

Separadores

Ecarteurs

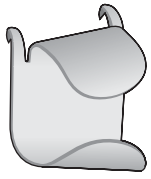

**MILLARD
ES-120**

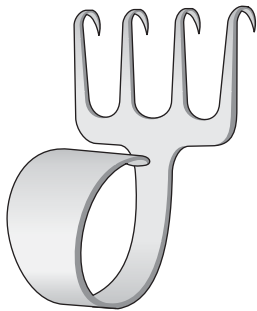

**FREEMAN
ES-121
50 mm**

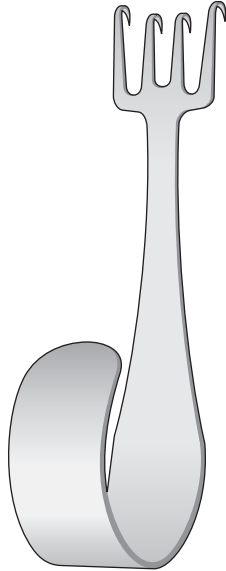

**FREEMAN
ES-122
100 mm**

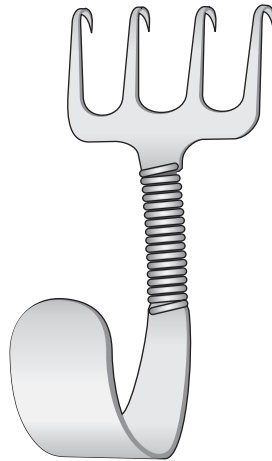

**GORNEY
ES-123
75 mm**

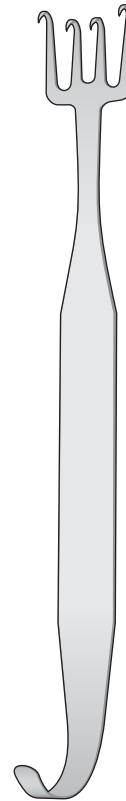

**FREEMAN
ES-124
180 mm**

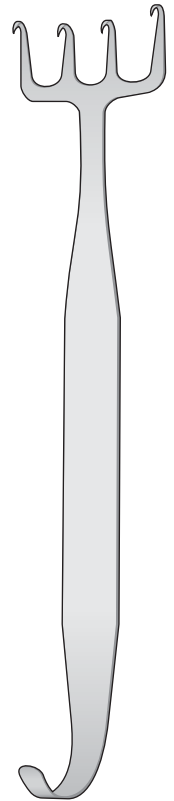

**FREEMAN
ES-125
180 mm**

Coronal Left Wundhaken
Coronal Lift Retractor
Divaricatore coronale

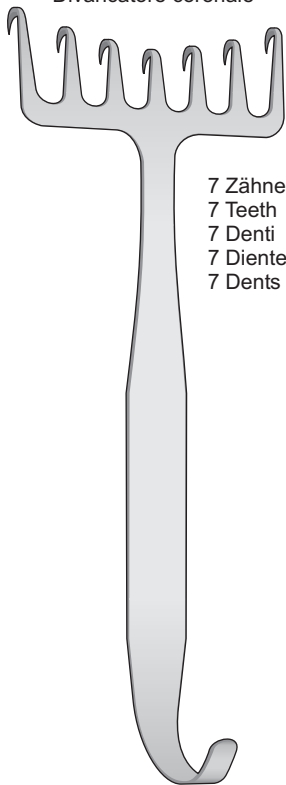

**CORONAL
ES-126
180 mm**

7 Zähne
7 Teeth
7 Denti
7 Dientes
7 Dents

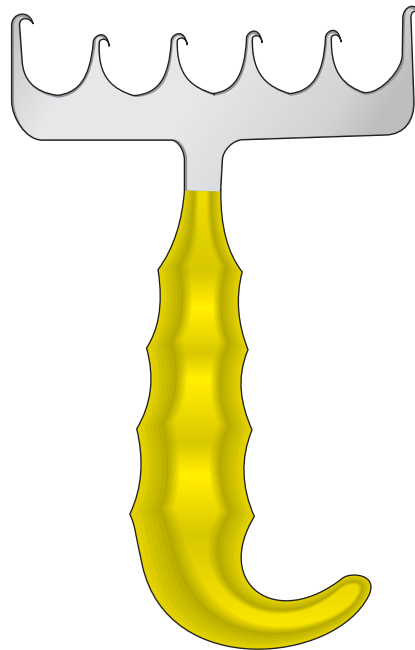

**YANCOSKIE
ES-127
150 mm**

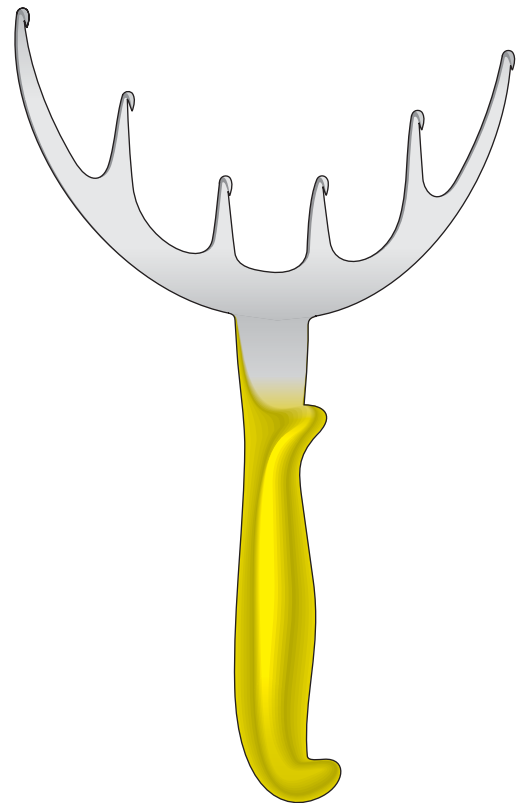

**FREEMAN
ES-128
180 mm**

Wundhaken

Retractors

Divaricatori

Separadores

Ecarteurs

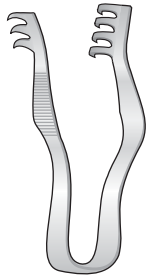

FINSEN
BV-36/BV-39
50 mm

Spitz 3x2 Zähne
Sharp 3x2 Teeth
Acuto 3x2 Denti
Agudas 3x2 Dientes
Pointü 3x2 Griffes

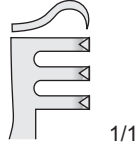

1/1

BV-36

Stumpf 3x2 Zähne
Blunt 3x2 Teeth
Smusso 3x2 Denti
Romas 3x2 Dientes
Mousse 3x2 Griffes

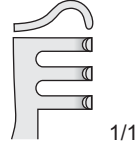

1/1

BV-37

Spitz 3x4 Zähne
Sharp 3x4 Teeth
Acuto 3x4 Denti
Agudas 3x4 Dientes
Pointü 3x4 Griffes

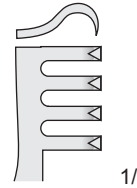

1/1

BV-38

Stumpf 3x4 Zähne
Blunt 3x4 Teeth
Smusso 3x4 Denti
Romas 3x4 Dientes
Mousse 3x4 Griffes

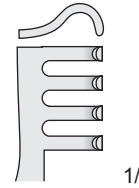

1/1

BV-39

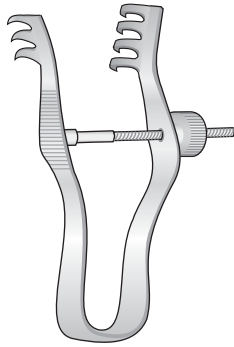

FINSEN
BV-47/BV-48
70 mm

Spitz 3x4 Zähne
Sharp 3x4 Teeth
Acuto 3x4 Denti
Agudas 3x4 Dientes
Pointü 3x4 Griffes

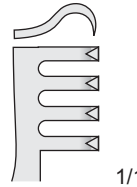

1/1

BV-47

Stumpf 3x4 Zähne
Blunt 3x4 Teeth
Smusso 3x4 Denti
Romas 3x4 Dientes
Mousse 3x4 Griffes

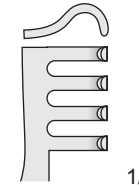

1/1

BV-48

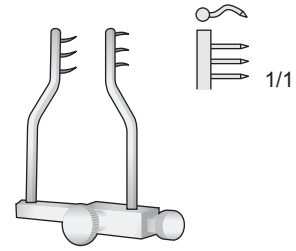

LOGAN
BV-45
40 mm

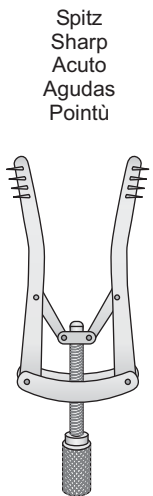

ALM
BV-12
70 mm

Spitz
Sharp
Acuto
Agudas
Pointü

Stumpf
Blunt
Smusso
Romas
Mousse

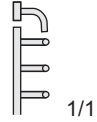

1/1

BV-49
70 mm

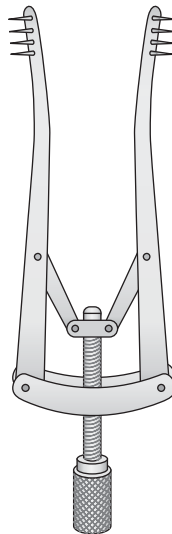

ALM
BV-10
100 mm

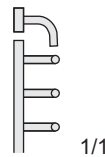

1/1

BV-51
100 mm

Spitz
Sharp
Acuto
Agudas
Pointü

Stumpf
Blunt
Smusso
Romas
Mousse



BV-08
100 mm

Wundhaken

Retractors

Divaricatori

Separadores

Ecarteurs

Spitz
Sharp
Acuto
Agudo
Pointu

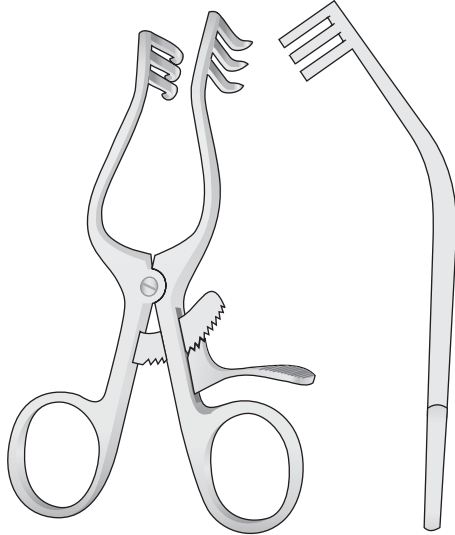

WULLSTEIN
BV-111
105 mm

Stumpf
Blunt
Smusso
Romo
Mousse

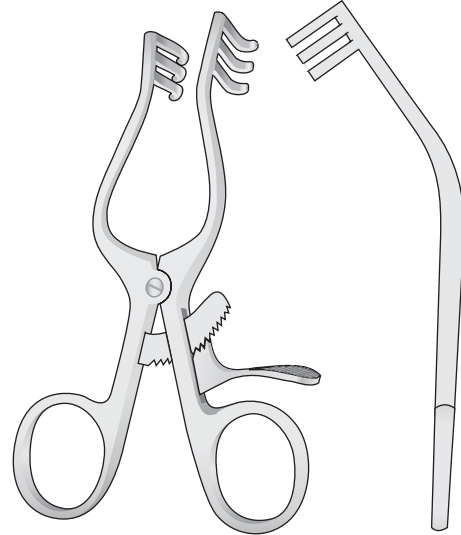

WULLSTEIN
BV-112
105 mm

Spitz
Sharp
Acuto
Agudo
Pointu

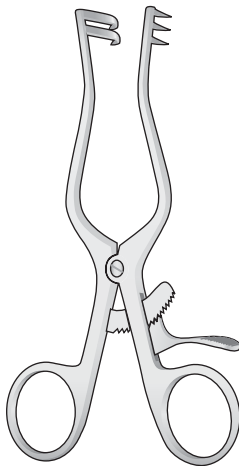

WEITLANER
BV-07
110 mm

Stumpf
Blunt
Smusso
Romo
Mousse

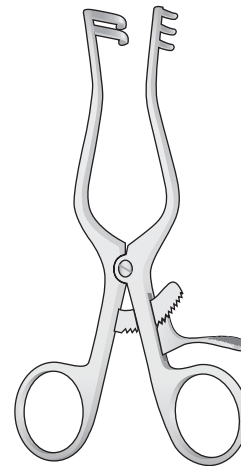

WEITLANER
BV-09
110 mm

Wundhaken

Retractors

Divaricatori

Separadores

Ecarteurs

Spitz
Sharp
Acuto
Agudo
Pointu

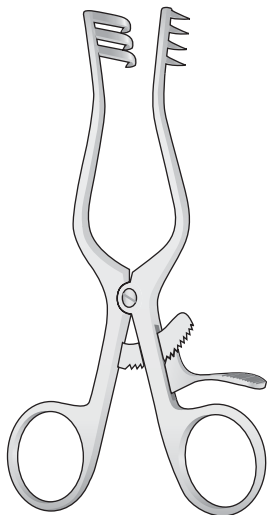
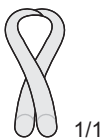

WEITLANER
BV-20
135 mm

Spitz - Sharp
Acuto - Agudo
Pointu

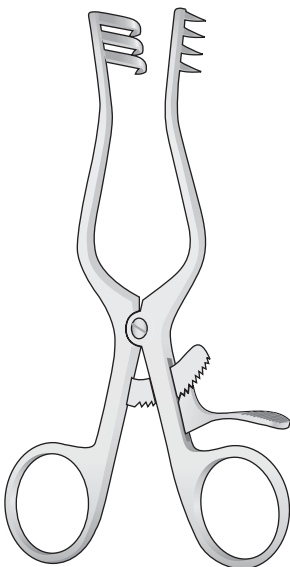

WEITLANER
BV-21
165 mm

Stumpf
Blunt
Smusso
Romo
Mousse

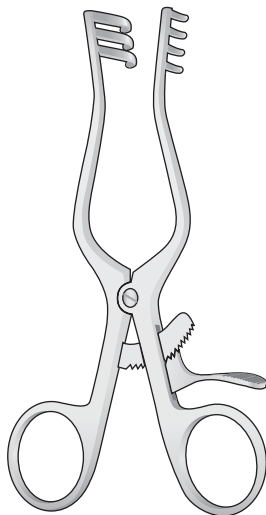

WEITLANER
BV-22
135 mm

Stumpf - Blunt
Smusso - Romo
Mousse

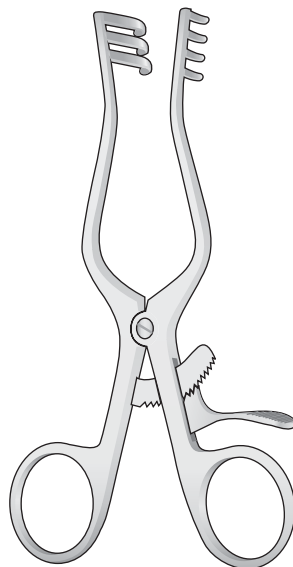

WEITLANER
BV-23
165 mm

Acuto
Scharp
Spitz
Pointu
Agudo

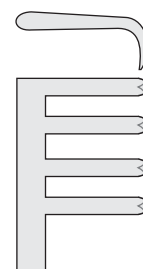

BV-68
140 mm

Smusso
Blunt
Stumpf
Mousse
Romas

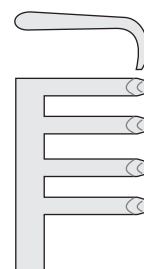

BV-70
140 mm

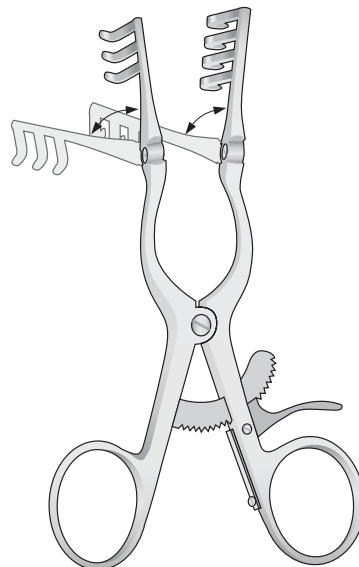

ADSON
BV-68/BV-70
140 mm

Wundhaken

Retractors

Divaricatori

Separadores

Ecarteurs

Spitz - Sharp - Acuto
Agudas - Pointu

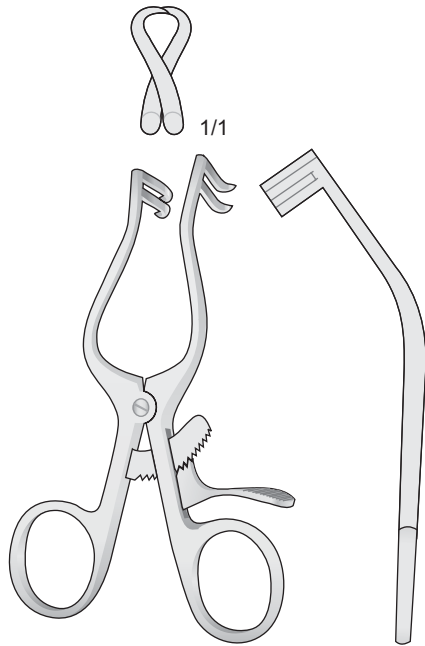

PLESTER
BV-90
110 mm

Stumpf - Blunt - Smusso
Romas - Mousse

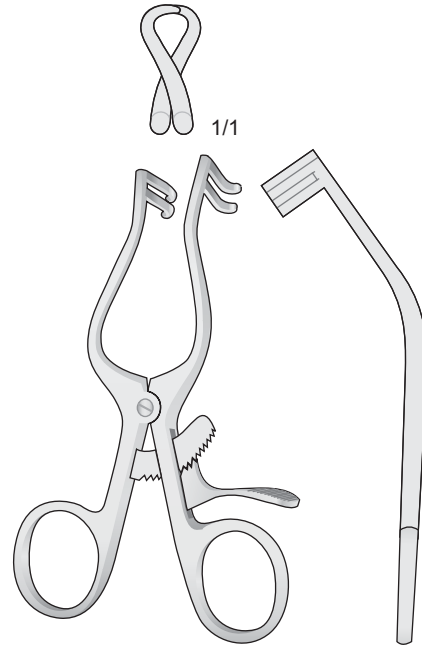

PLESTER
BV-91
110 mm

Spitz - Sharp - Acuto
Agudas - Pointu

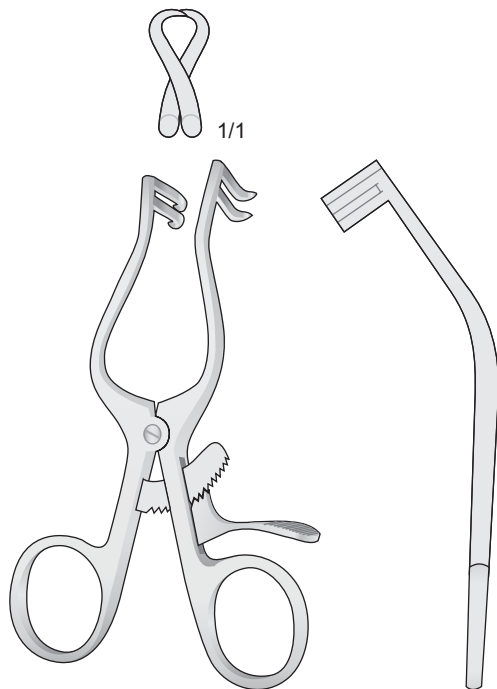

PLESTER
BV-92
135 mm

Stumpf - Blunt - Smusso
Romas - Mousse

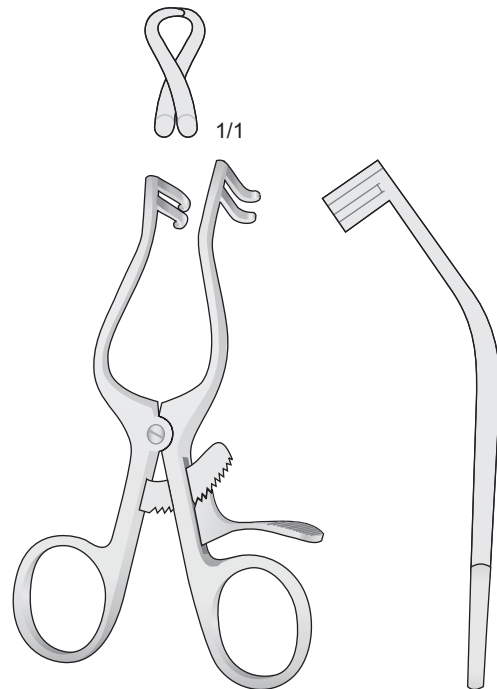

PLESTER
BV-93
135 mm

Haken Stripper

Vein Stripper

Uncini per vene

Sonda para varices

Stripper a anneau

Varizeninstrumente
Varix Instruments
Strumenti per varici
Instrumentos para varices
Instruments pour varices

Phlebodissektor - Phlebodissector
Flebodisettore - Flebodisecador
Dissecteur pour phlébite

ES-150
Komplettset mit
Set complete with
Set completo con
Set completo con
Set complete avec
ES-151 + ES-152 + ES-153

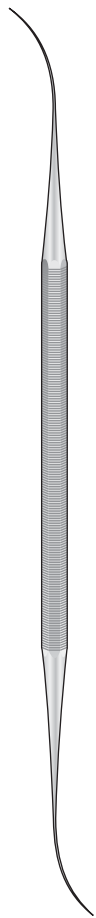

VARADY
FB-107
180 mm

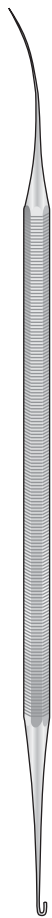

VARADY
FB-108
180 mm



VARADY
FB-109
180 mm

Fig. 1



ES-151
140 mm

Fig. 2

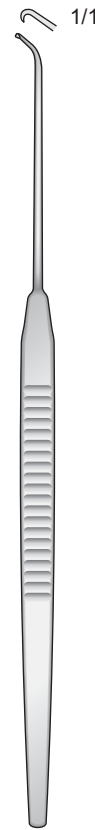

ES-152
140 mm

Fig. 3

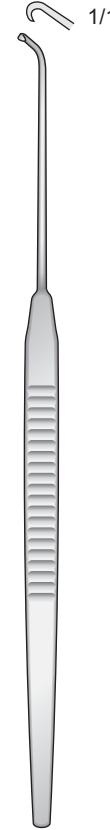

ES-153
140 mm

Venen-Stripper-
Instrumente

Vein Stripper
instruments

Strumenti per stripping
di vene

Instrumentos para
varices

Instruments pour
stripping veineux

FB-390
Krampfaderbesteck komplett
Varicose Vein Probe Set complete
Set completo sonda per varici
Juego para varices completo
Trousse à varices complète

Metall-Sondenspitzen
Probe tip, metal
Punta per sonda
in metallo
Punta metálica
Pointe en métal

Ø 3 mm

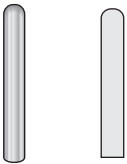

FB-394



FB-395/FB-398



Ø 6 mm

FB-395



Ø 9 mm

FB-396



Ø 12 mm

FB-397

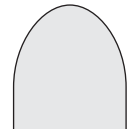

Ø 15 mm

FB-398

Oliven - Olives - Olive - Oliva - Olive

Griff Allein
Handle only
Manico solo
Mango solo
Manche seule

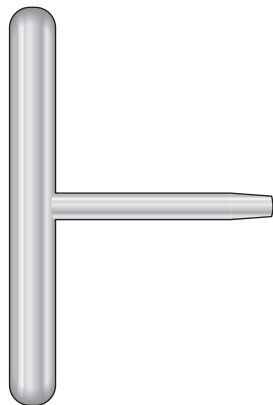

FB-400

Zugseil
Traction Cable
Cavo per trazione
Cable de tracción
Cable tracteur

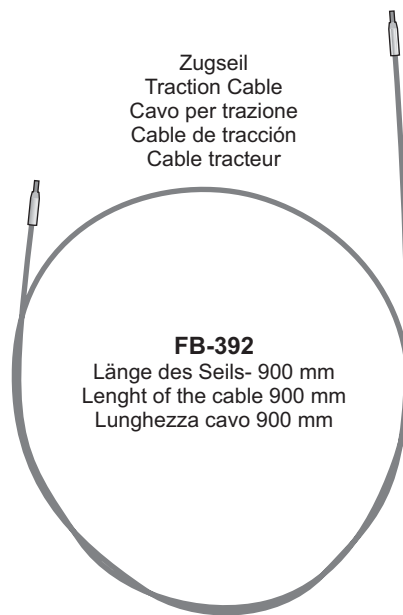

FB-392
Länge des Seils- 900 mm
Length of the cable 900 mm
Lunghezza cavo 900 mm

Wundhaken

Retractors

Divaricatori

Separadores

Ecarteurs

Nasenhaken
Nasal Retractors
Divaricatori nasali
Separadores nasales
Ecarteurs nasaux

Wundhaken mit Fiberoptikstab oval
Retractors with Fiber optic oval
Divaricatore a fibra ottica ovale
Retractor con iluminación de luz fría
Ecarteur avec illumination à lumière froide

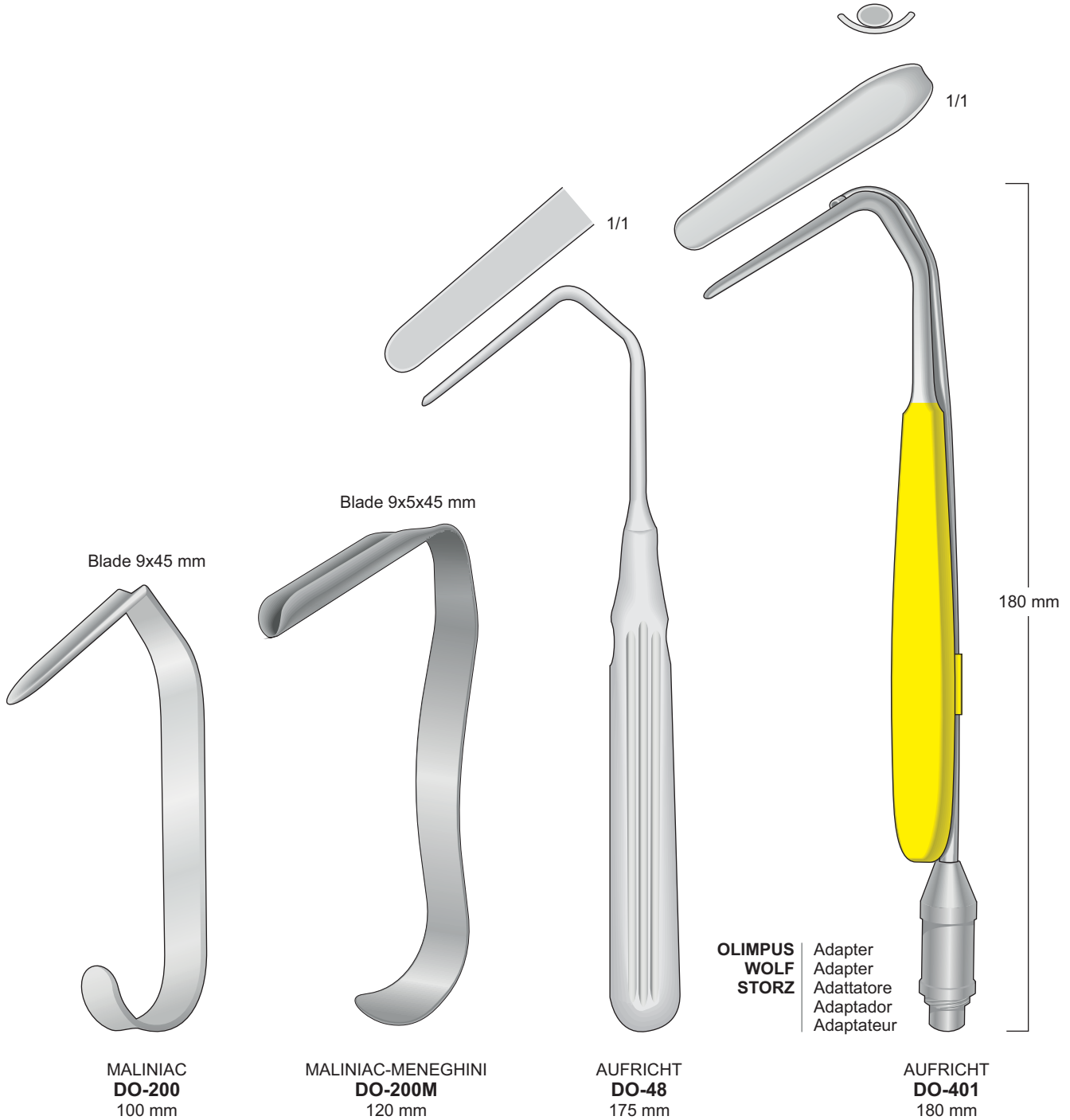

Nasen Spekula
Nasal specula
Speculum nasali
Espéculos nasales
Spéculums nasaux

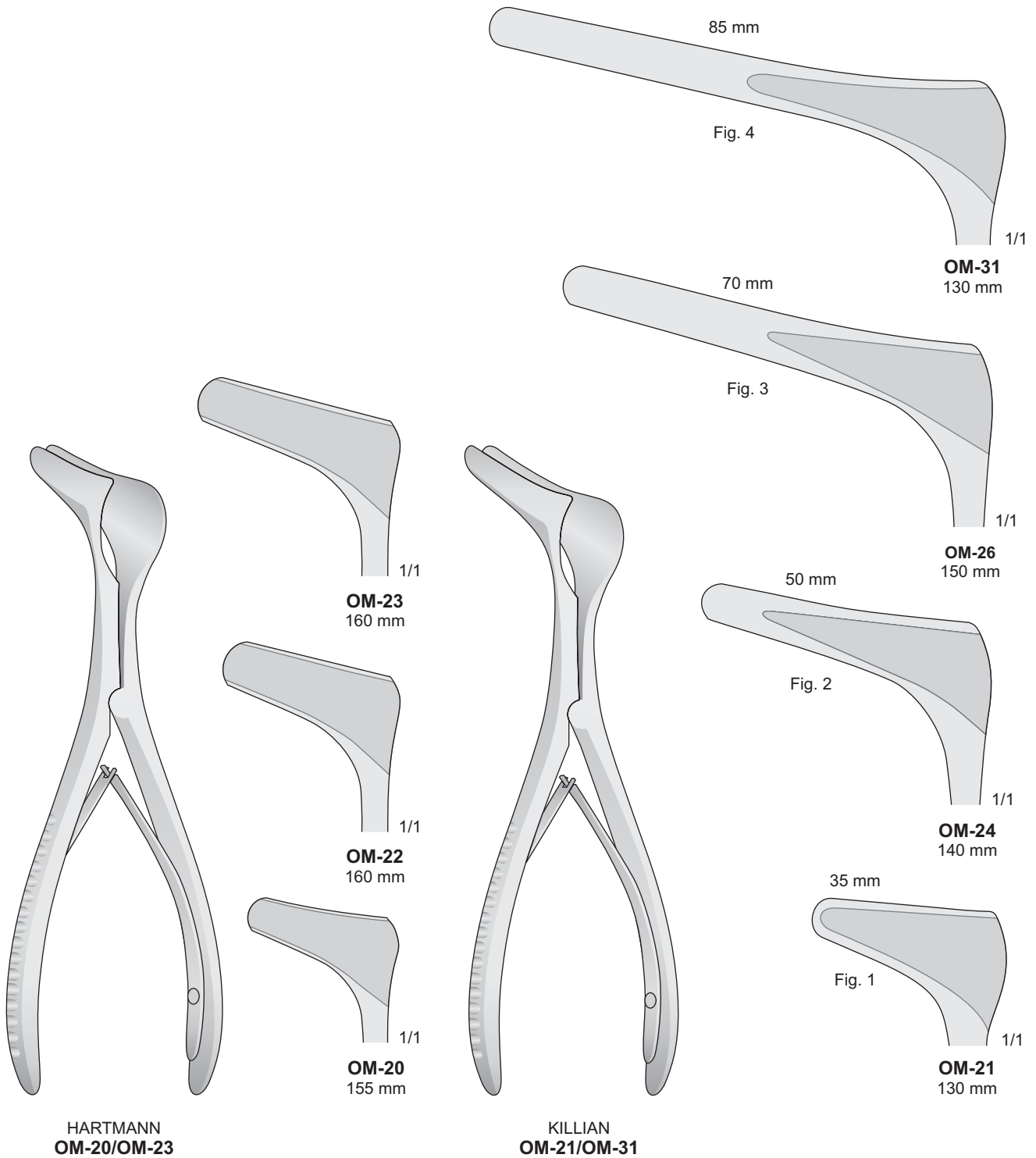

Nasen Spekula
Nasal specula
Speculum nasali
Espéculos nasales
Spéculums nasaux

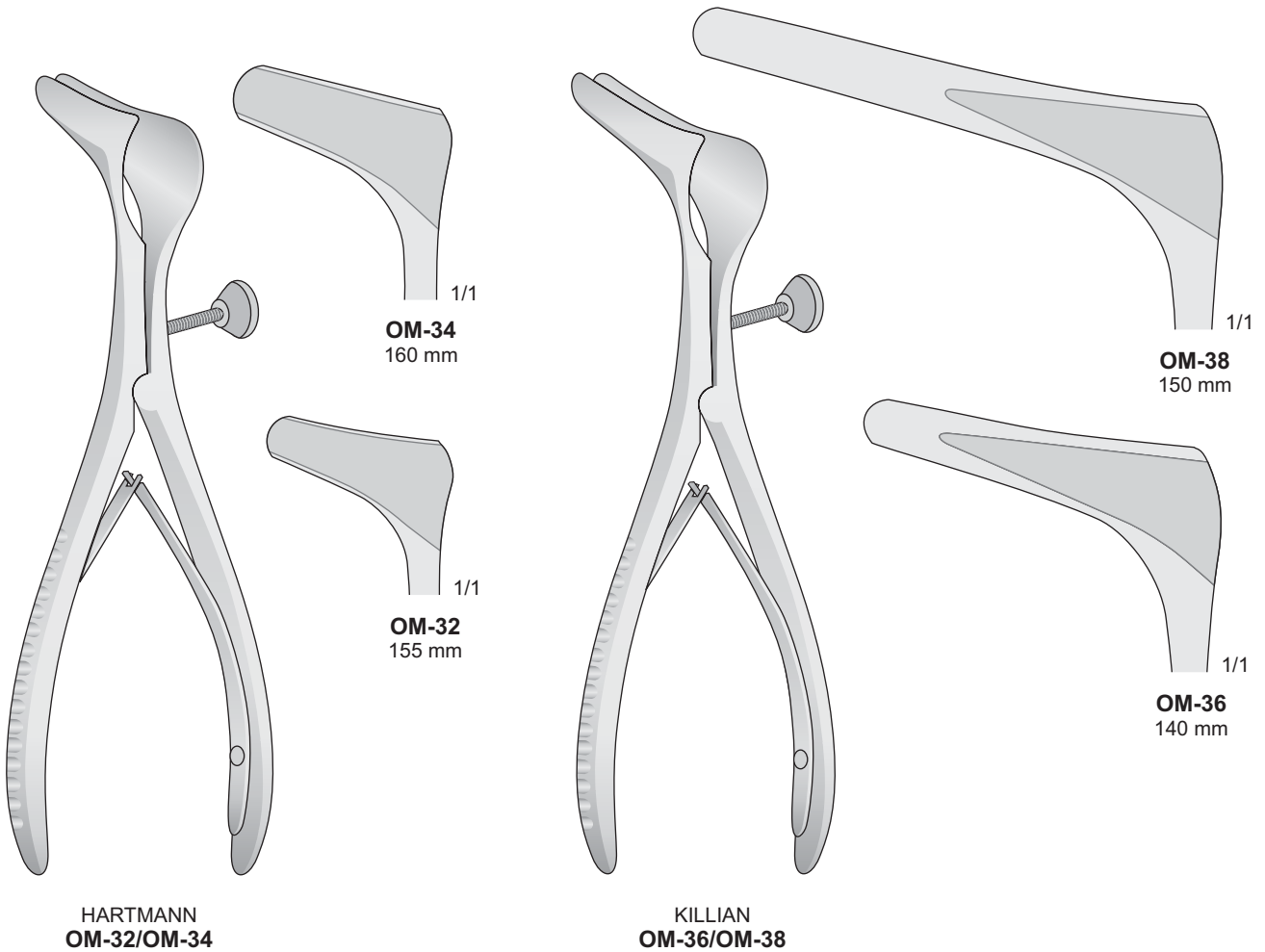

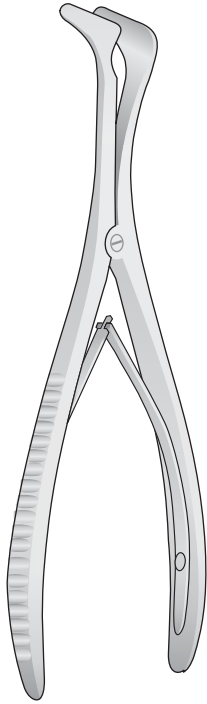

TIECK-HALLE
OM-48/OM-49
135 mm

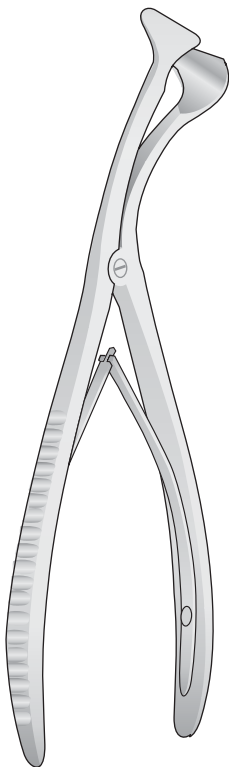
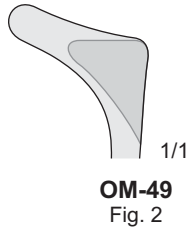
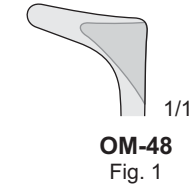

BECKMANN
OM-51/OM-54
150 mm

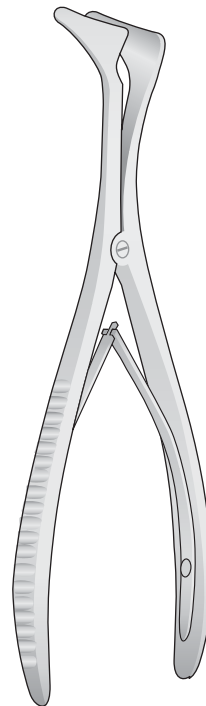
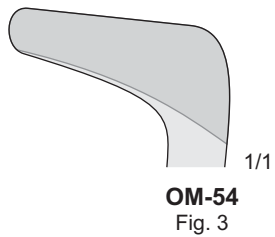
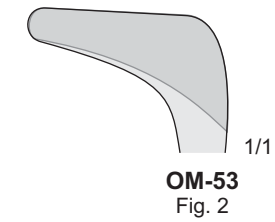
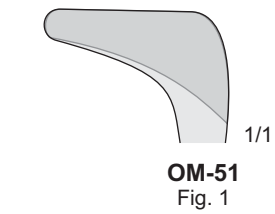

MODELL WIEN
OM-56/OM-59
140 mm

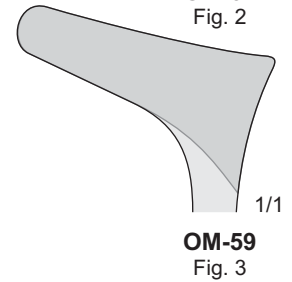
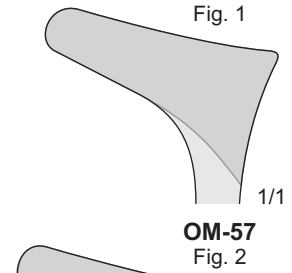
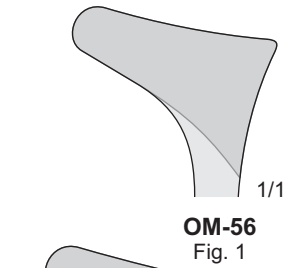

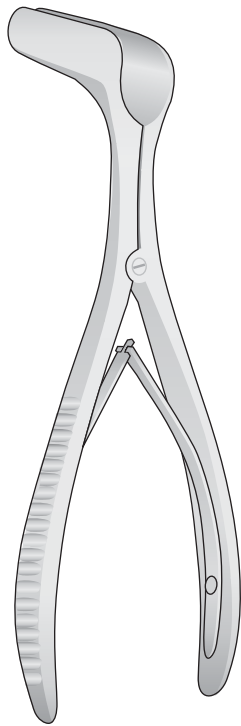

PAPAVERO-HARTMANN
OM-39
140 mm

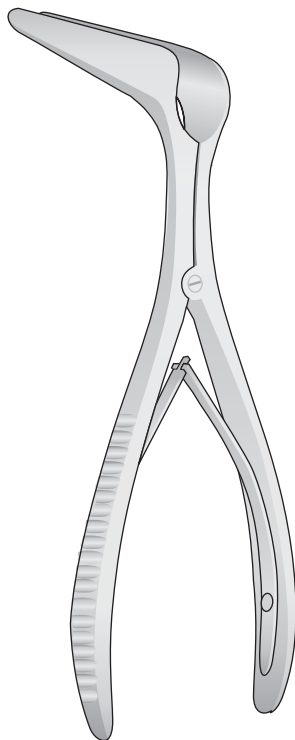

COTTLE
OM-25/OM-29
150 mm

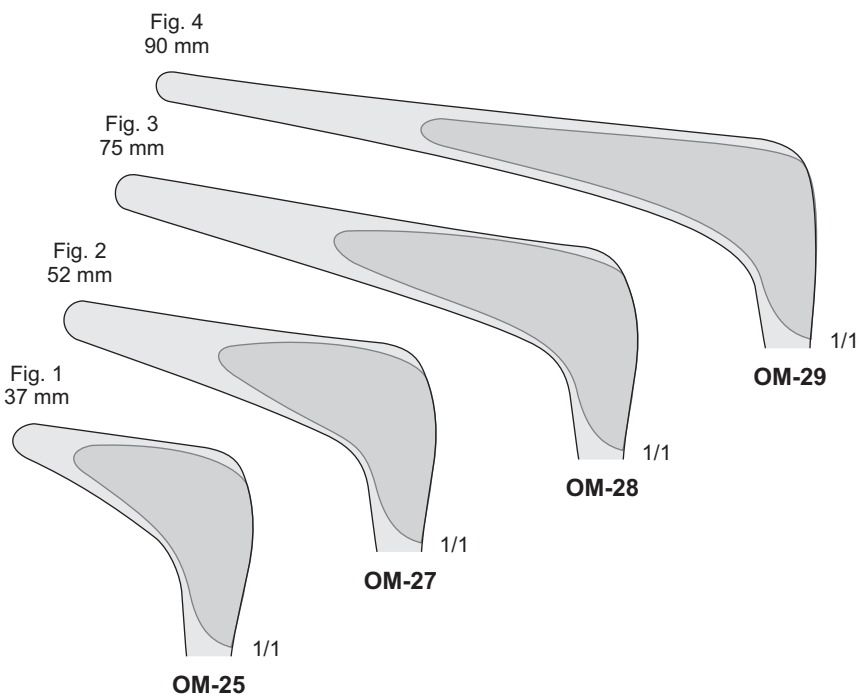

Elevatorii

Elevators

Elevatori

Elevadores

Elevateurs

Raspatorii
Periosteal Raspatories
Periostotomi
Legras periostotomos
Rugines à périostomie

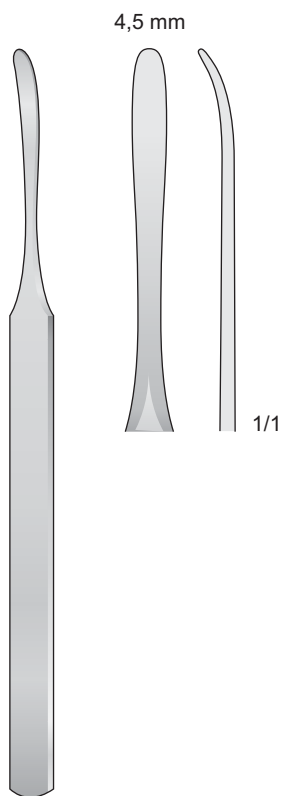

**KÖNIG
KO-1**
155 mm

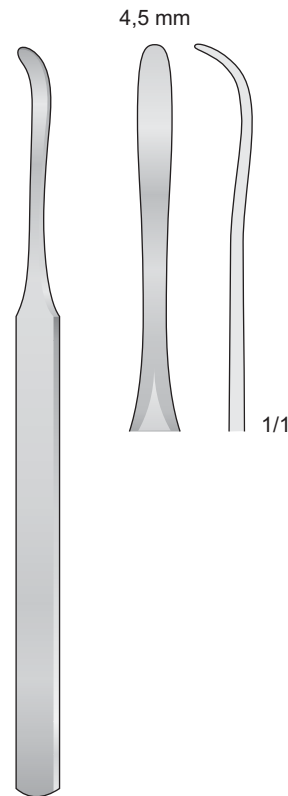

**KÖNIG
KO-2**
155 mm

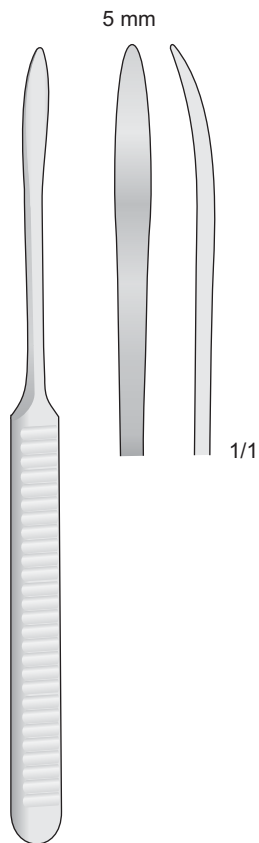

**WILLIGER
WG-10**
165 mm

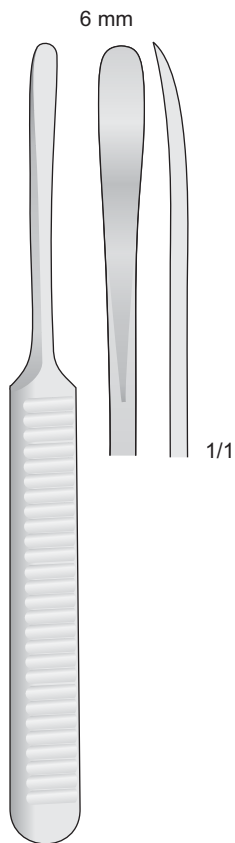

**WILLIGER
WG-12**
160 mm

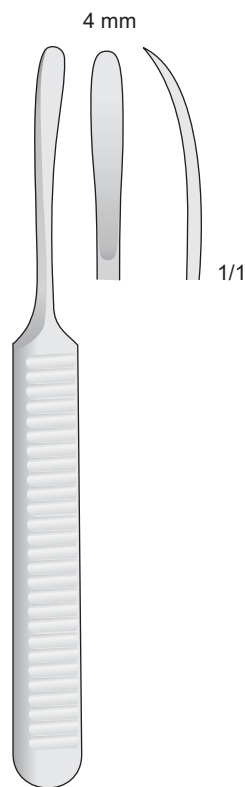

**WILLIGER
WG-14**
140 mm

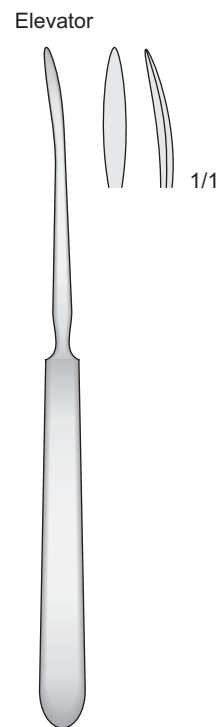

**LUENEURG
FR-10**
115 mm

Dissektoren
Separatoren

Dissectors
Seperators

Dissettori
Separatori

Disecadores
Descoladores

Dissecteurs
Separateurs

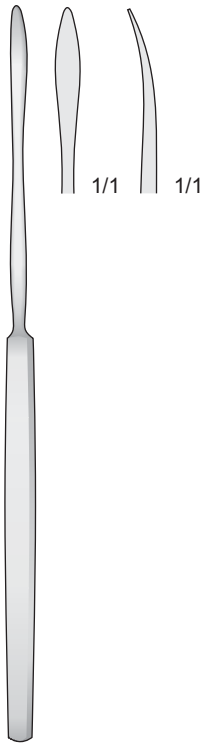

KO-18
175 mm

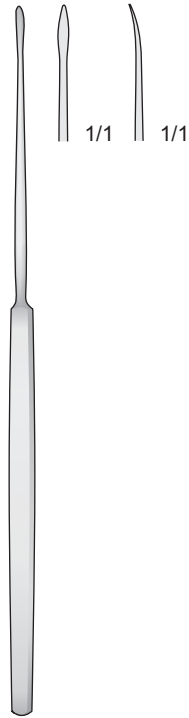

KO-19
160 mm



**YANKAUER
KO-54**
210 mm

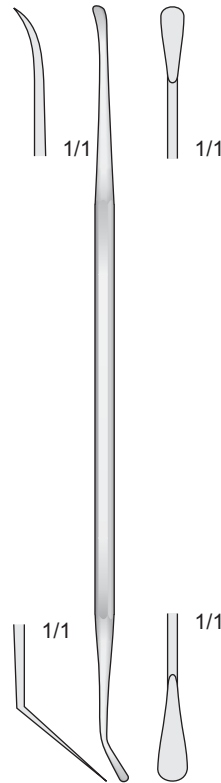

**MILLIGAN
KO-27**
210 mm

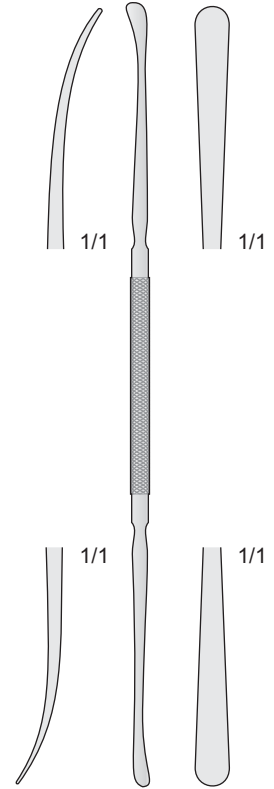

**DAVIS
KO-21**
245 mm

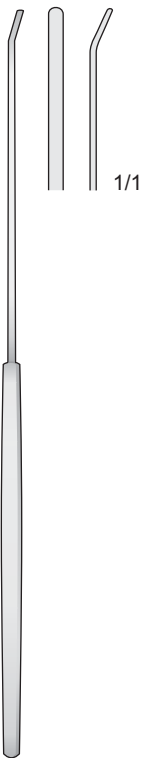

**FAGER
KO-24**
200 mm

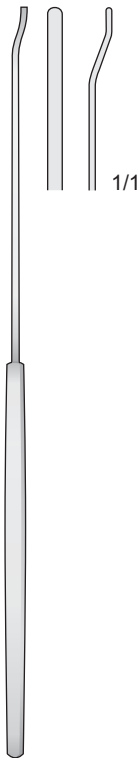

**FAGER
KO-25**
200 mm



**SACHS
KO-26**
210 mm

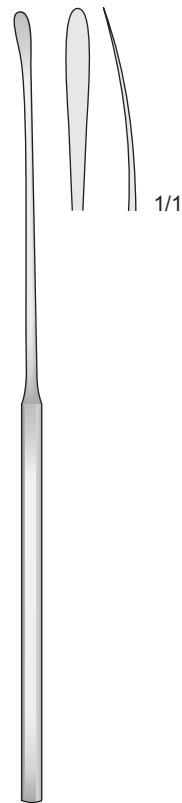

**SACHS
KO-28**
210 mm

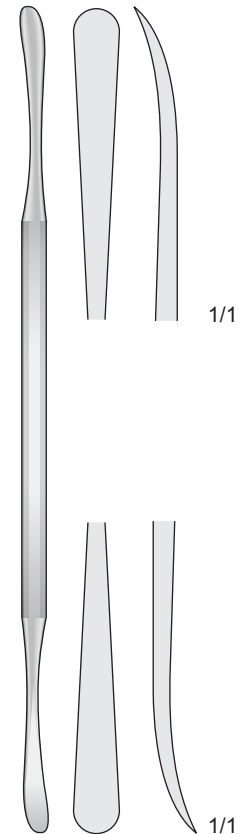

KO-29
220 mm

Dissektoren
Separatoren

Dissectors
Seperators

Dissettori
Separatori

Disecadores
Descoladores

Dissecteurs
Separateurs

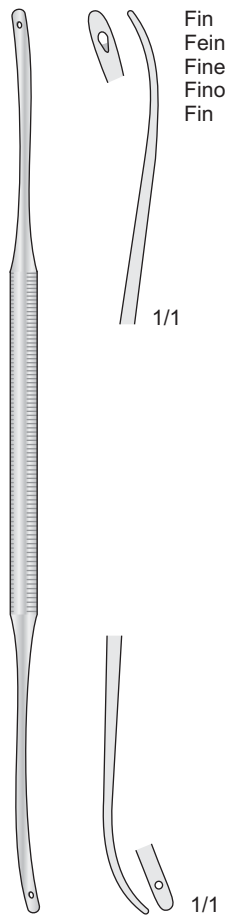

KO-14 - 180 mm
KO-15 - 240 mm

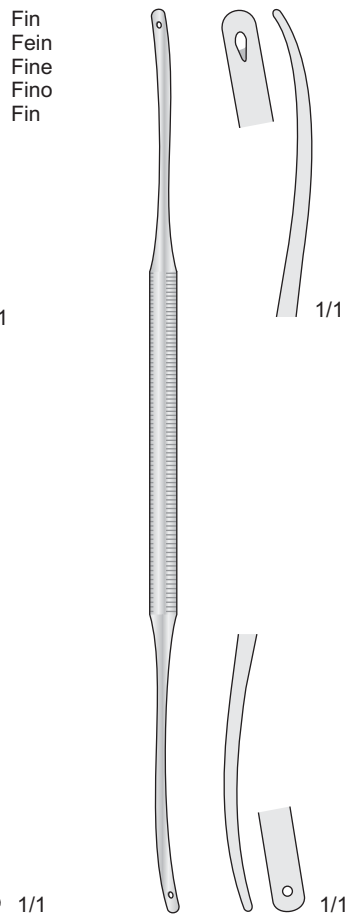

KO-16 - 180 mm
KO-17 - 240 mm

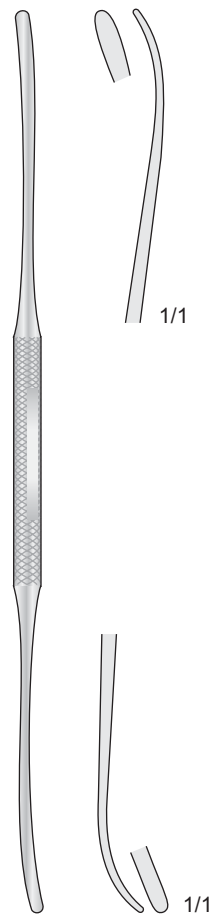

OLIVECRONA
KO-47 - 180mm
KO-48 - 240mm

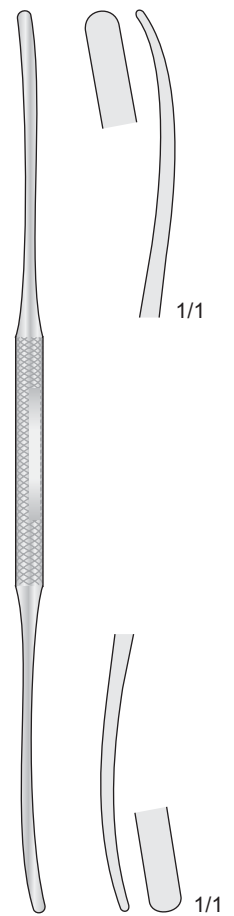

OLIVECRONA
KO-49 - 195mm
KO-50 - 240mm

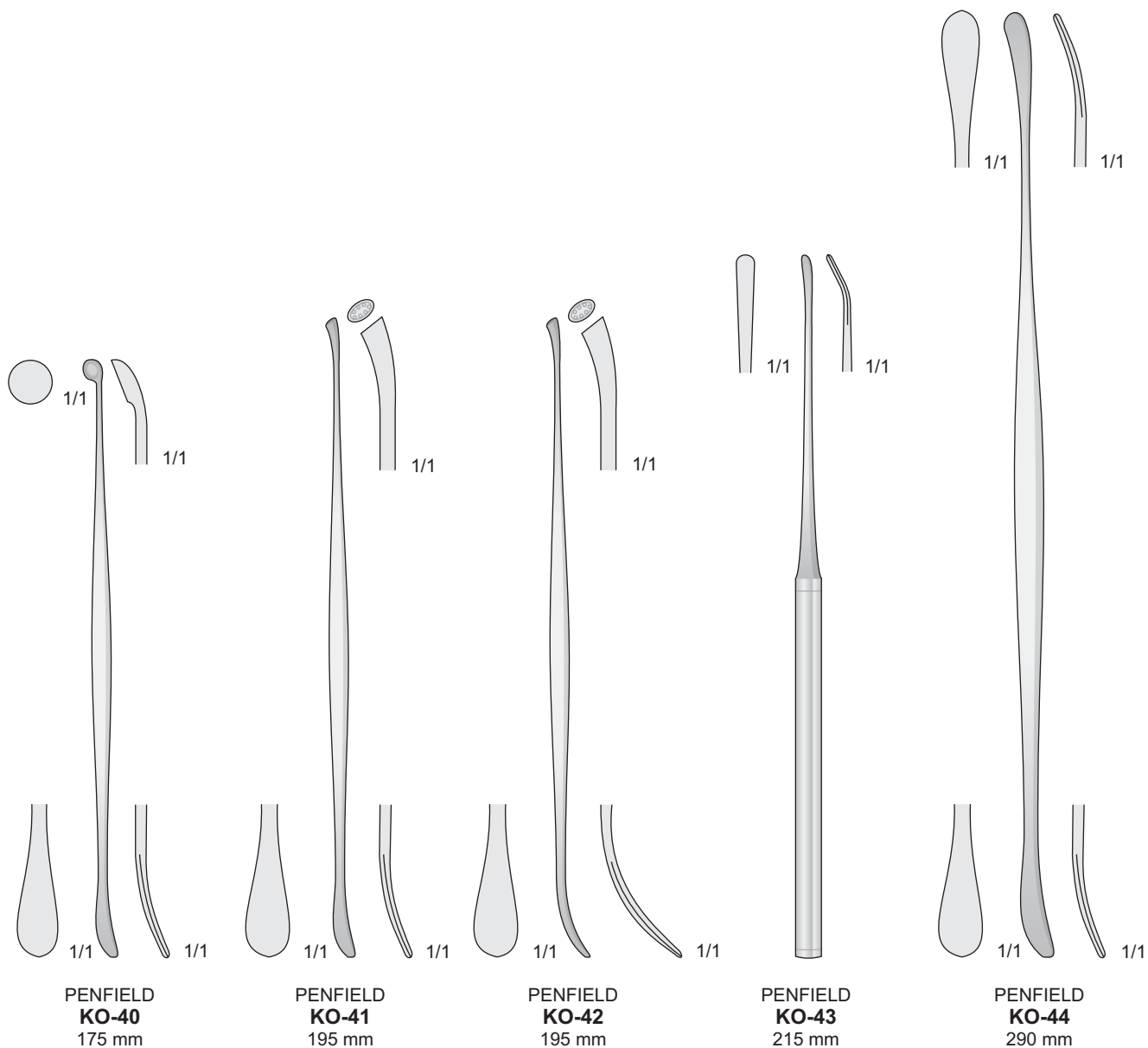

Raspatorien

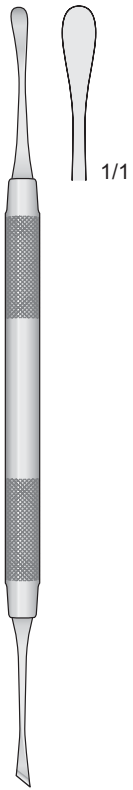

718-24G
185 mm

Raspatories

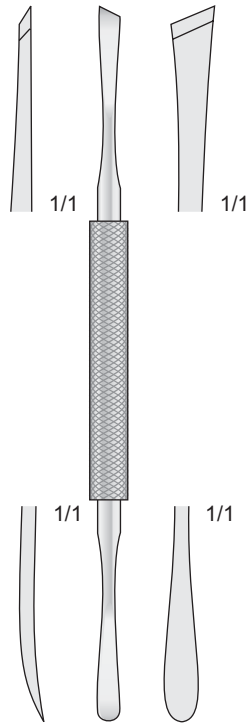

MEAD
165 mm

Periostotomi

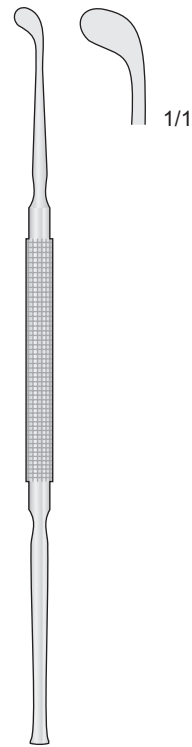

**FREER
FR-15**
190 mm

Legras

4,5 mm

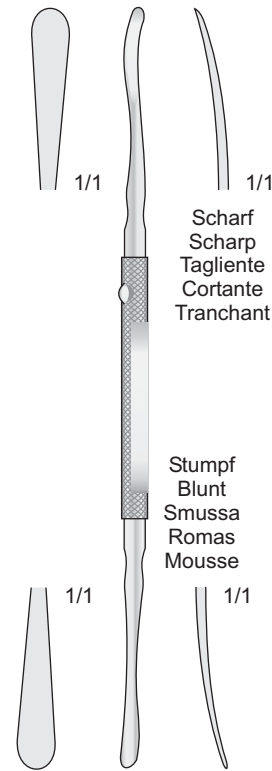

FREER
180 mm

Scharf
Scharp
Tagliente
Cortante
Tranchant

Stumpf
Blunt
Smussa
Romas
Mousse

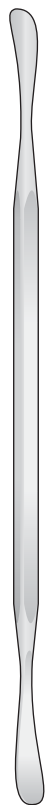

**ALDERDYCE
KO-39**
210 mm

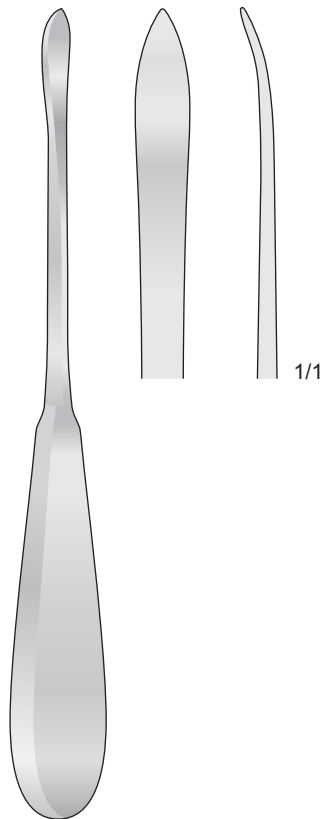

**LANGENBECK
FK-12**
200 mm

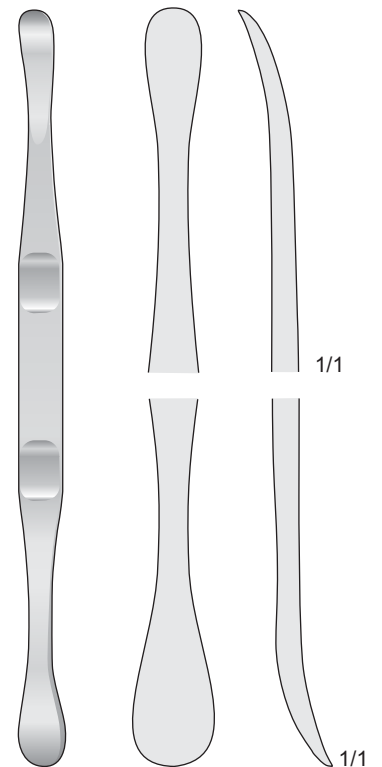

**BABBUSH
KO-20**
180 mm

Raspatorien

Raspatories

Periostotomi

Legras

Rugines

Septum Elevatorien
Periosteal Elevators
Elevatori per il setto nasale
Elevadores para el tabique nasal
Elévateurs pour cloison nasale

4 mm

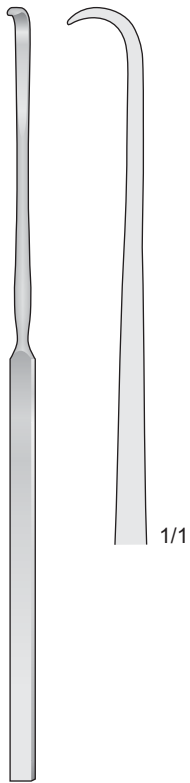

DO-244
200 mm

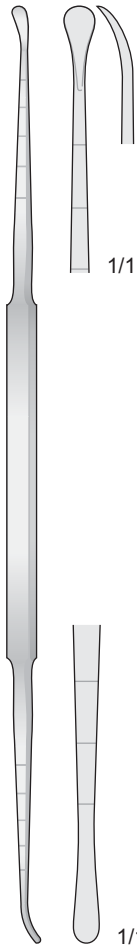

COTTLE DO-60
220 mm

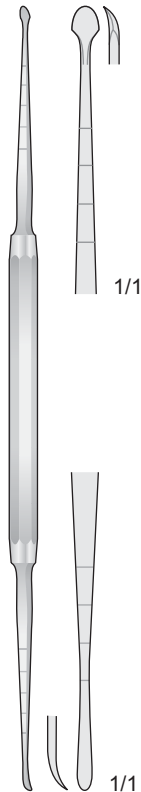

MASING DO-47
210 mm

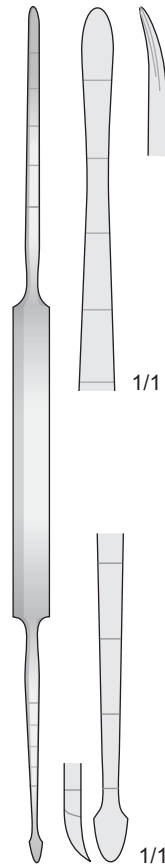

COTTLE DO-111
210 mm

5 mm

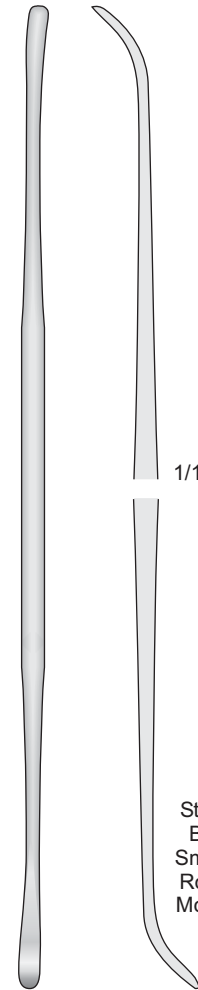

SALZBURG DO-240
245 mm

5 mm

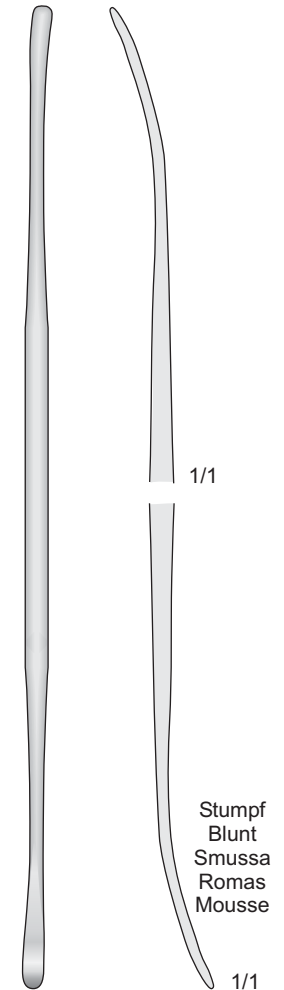

SALZBURG DO-241
245 mm

Scharf
Sharp
Tagliente
Cortante
Tranchant

1/1

Stumpf
Blunt
Smussa
Romas
Mousse

1/1

Scharf
Sharp
Tagliente
Cortante
Tranchant

1/1

Stumpf
Blunt
Smussa
Romas
Mousse

1/1

Raspatorien

Raspatories

Periostotomi

Legras

Rugines

Septum Elevatorien - Periosteal Elevators - Elevatori per il setto nasale - Elevadores para el tabique nasal - Elévateurs pour cloison nasale

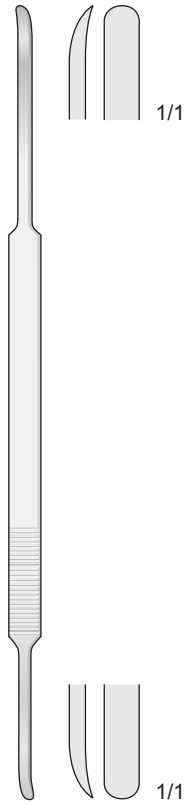

MCKENTY
KO-46
220 mm



BALLENGER-HAYEK
KO-61 190 mm
KO-62 220 mm

Scharf/Stumpf
Sharp/Blunt
Tagliente/Smusso
Cortante/Romo
Tranchant/Mousse

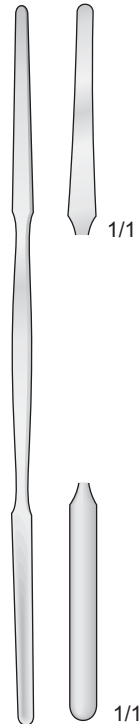

KILLIAN
KO-63
180 mm

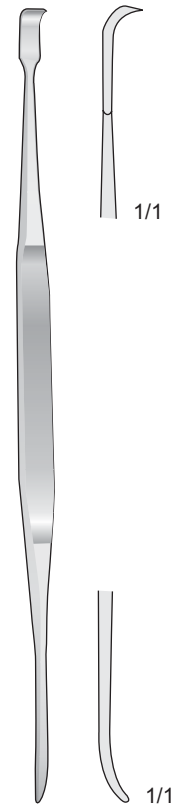

HOWARTH
KO-30
210 mm

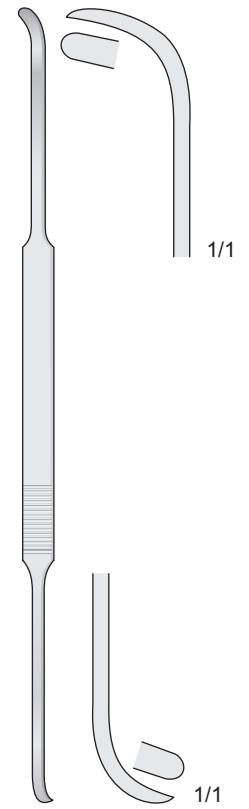

COTTLE
KO-12
230 mm

Scharf/Stumpf - Sharp/Blunt
Tagliente/Smusso - Cortante/Romo
Tranchant/Mousse

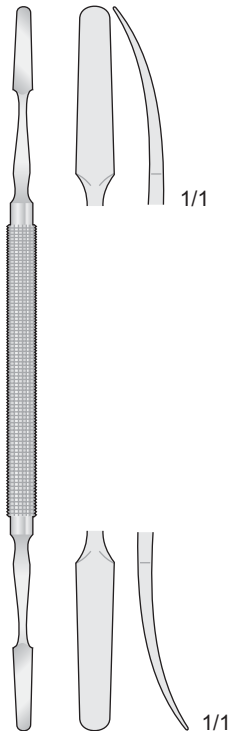

KILLIAN
KO-11
180 mm



KILLIAN
KO-13
220 mm

Scharf/Stumpf
Sharp/Blunt
Tagliente/Smusso
Cortante/Romo
Tranchant/Mousse

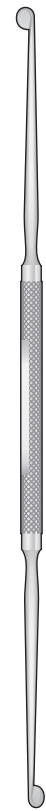

PIERCE
KO-64
210 mm

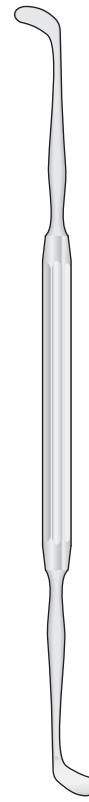

PENNINGTON
KO-65
210 mm

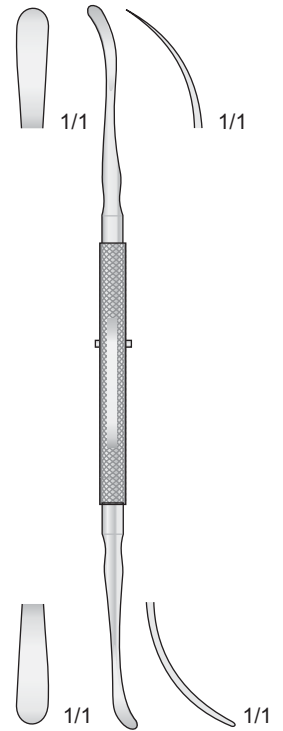

ROGER
KO-66
180 mm

Raspatorien

Raspatories

Periostotomi

Legras

Rugines

Raspatorien, Elevatorien, Flachmeißel - Raspatories, Elevators, Chisels

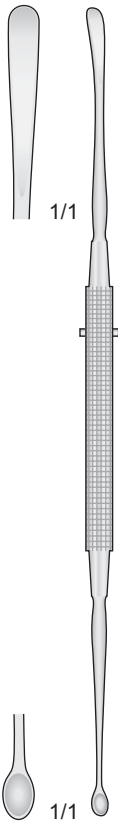

**CARTER
KO-67**
210 mm

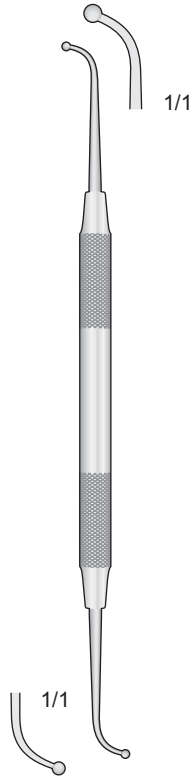

712-18
180 mm

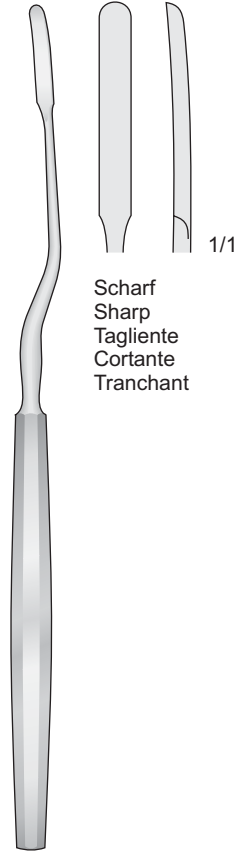

**MASING
KO-68**
220 mm

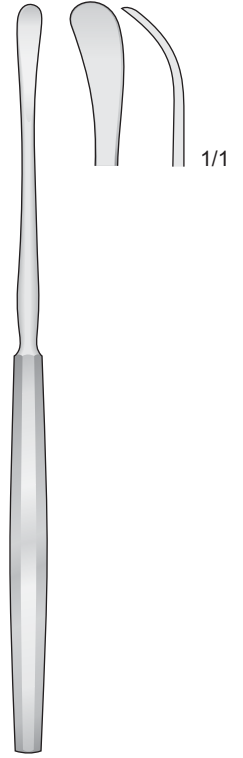

**SEWALL
KO-69**
200 mm

Scharf
Sharp
Tagliente
Cortante
Tranchant

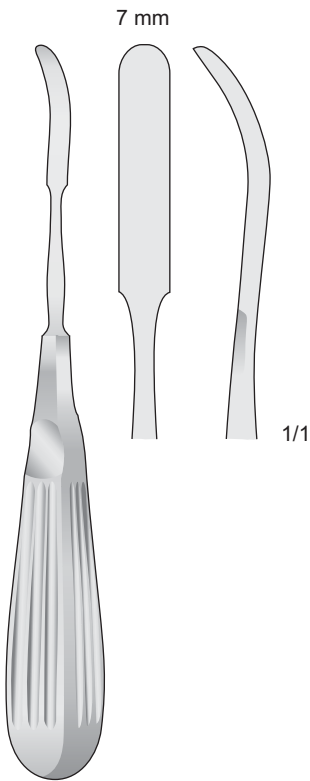

**JOSEPH
FK-82**
180 mm



**COTTLE
DO-211**
180 mm

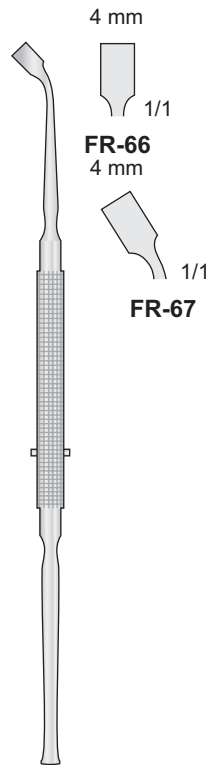

**FREER
FR-66/FR-67**
190 mm

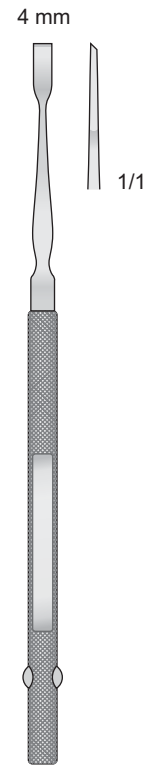

TG-11
160 mm

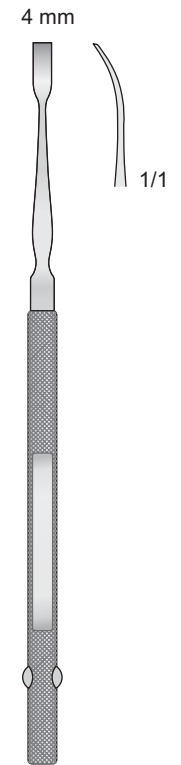

**FREER
TG-23**
160 mm

Raspatorien

Raspatories

Periostotomi

Legras

Rugines

Septum Elevatorien - Periosteal Elevators - Elevatori per il setto nasale
Elevadores para el tabique nasal - Elévateurs pour cloison nasale

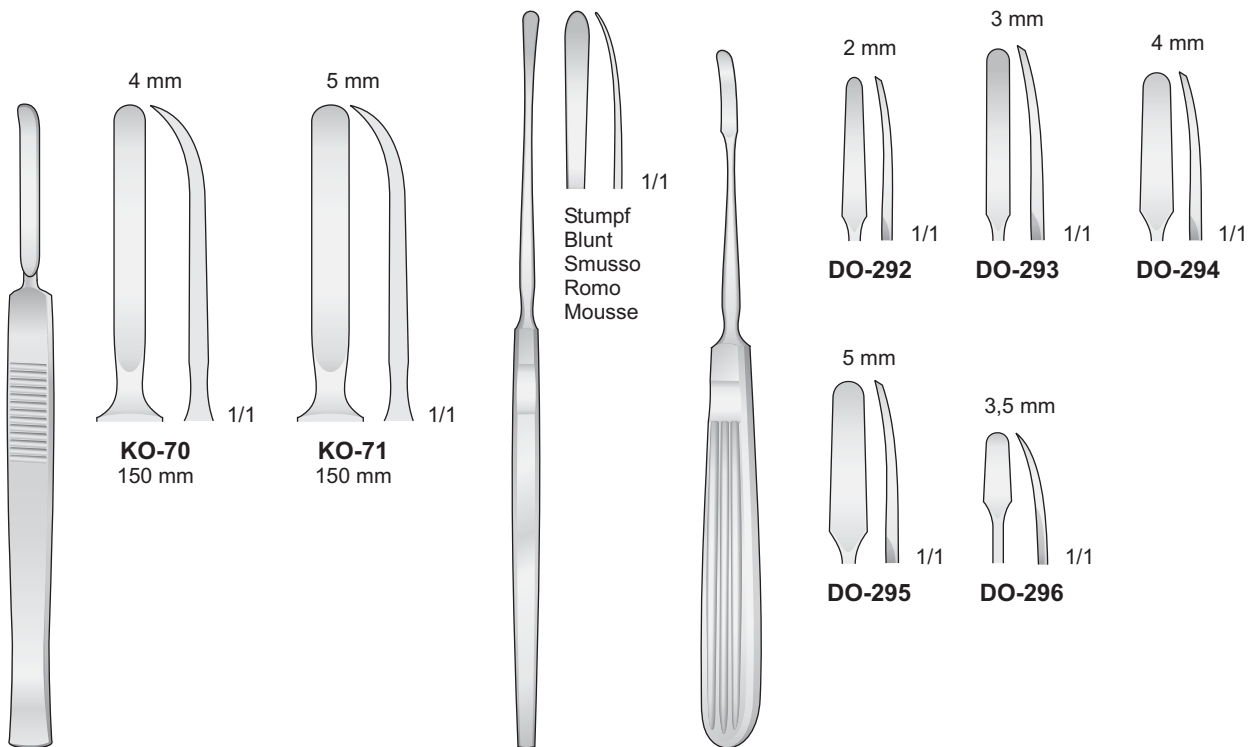

Mc KENTY
KO-70/KO-71
150 mm

KO-72
180 mm

WALTON
DO-292/DO-296
160 mm

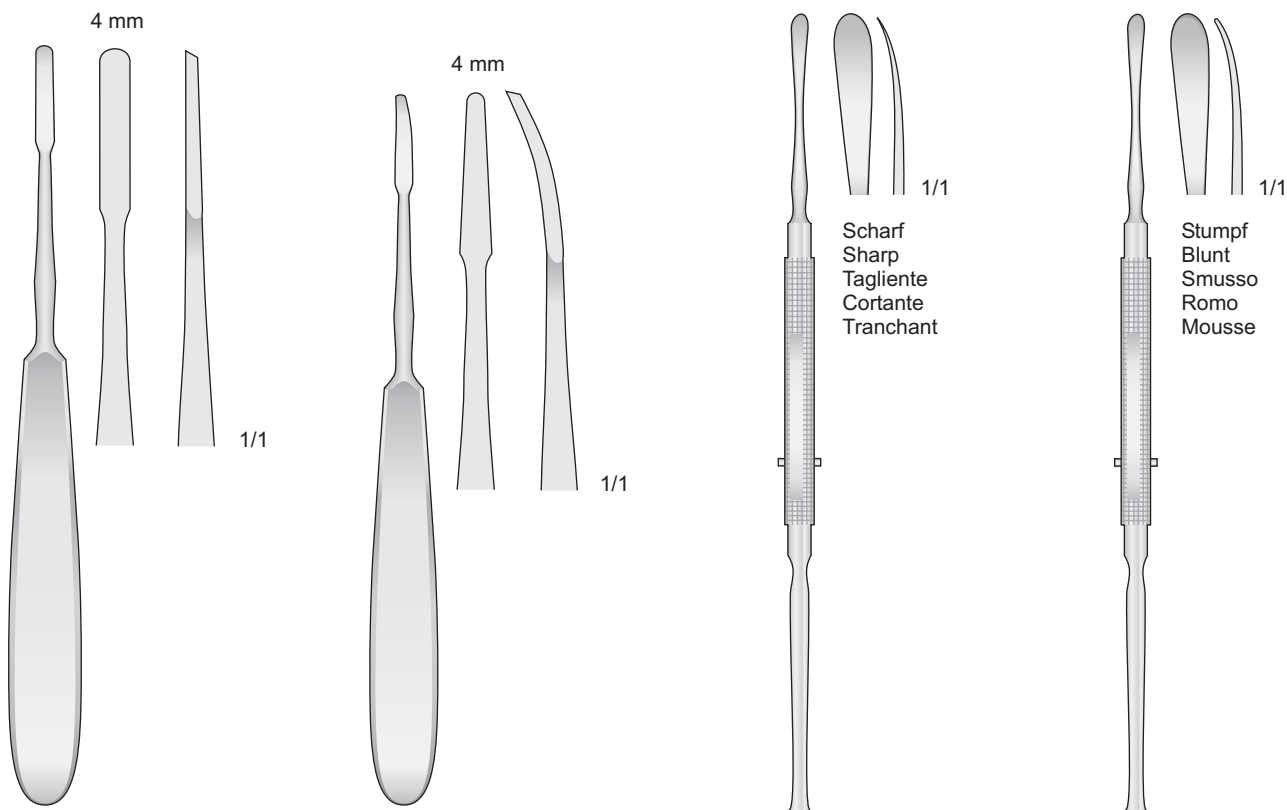

FOMON
FK-264
170 mm

JOSEPH
FK-265
160 mm

FREER
FR-64
190 mm

FREER
FR-65
190 mm

Raspatorien

Raspatories

Periostotomi

Legras

Rugines

Raspatorien - Scharf
Raspatories - Sharp
Periostotomi - Taglienti
Legras - Cortante
Rugines - Tranchant

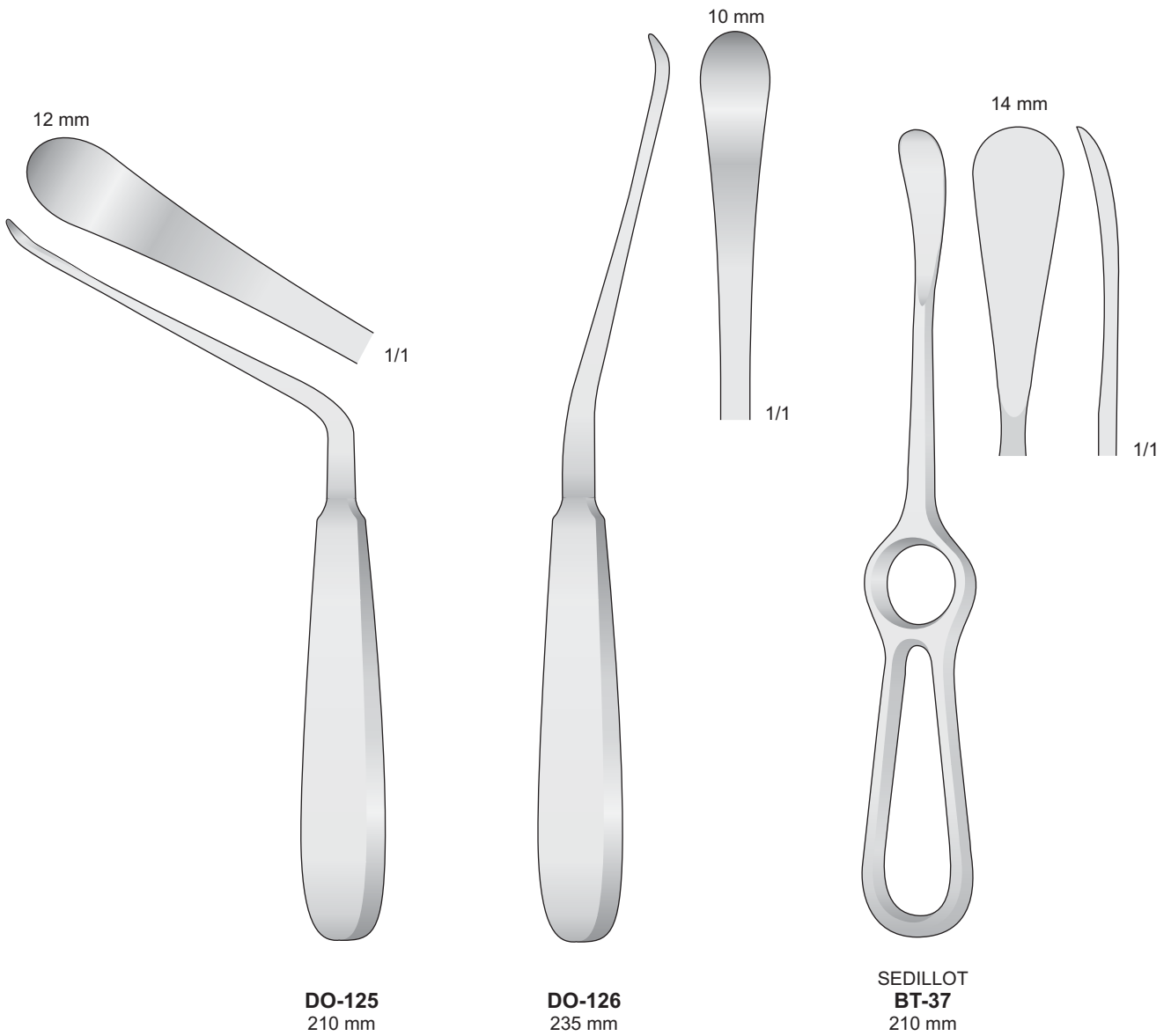

Raspatorien

Raspatories

Periostotomi

Legras

Rugines

Periosteal elevators

Scharf
Sharp
Taglienti
Cortante
Tranchant

6 mm

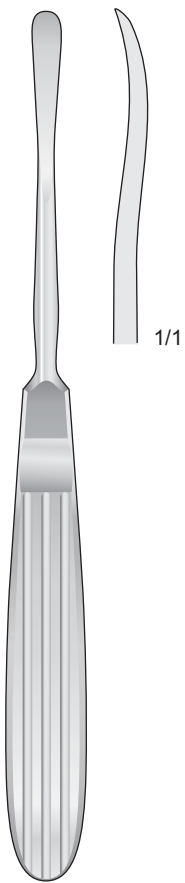

OBWEGESER
DO-59
175 mm

7 mm

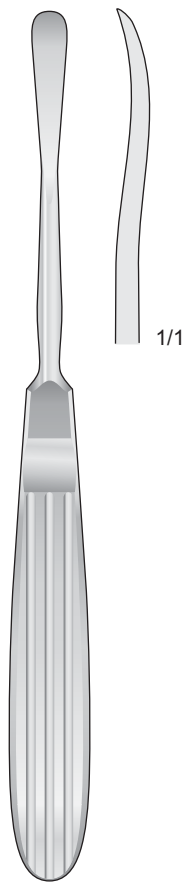

OBWEGESER
DO-63
175 mm

9 mm

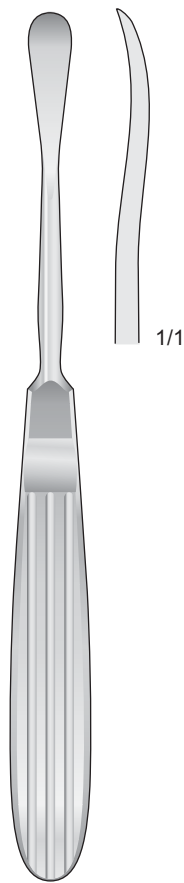

OBWEGESER
DO-67
175 mm

11 mm

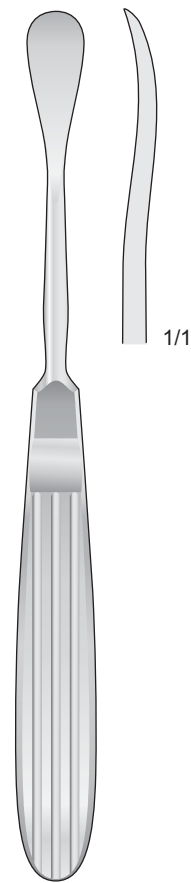

OBWEGESER
DO-65
175 mm

Raspatorien

Raspatories

Periostotomi

Legras

Rugines

Raspatorien, Elevatorien
Raspatories, Elevators

Massiv - Solid - Manico pieno - Massif

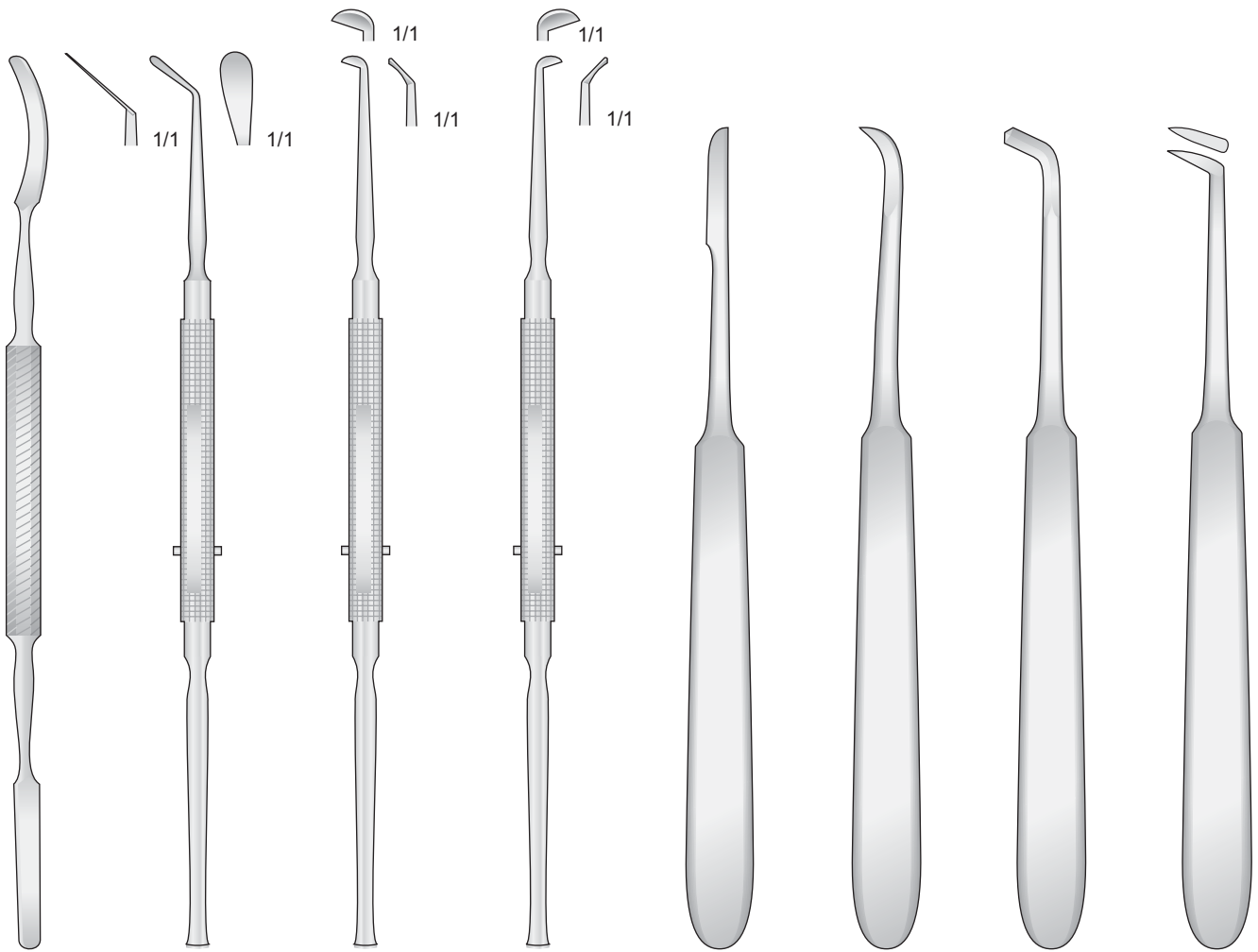

MC DONALD
KO-38
190 mm

FREER
FR-100

FREER
FR-166

FREER
FR-167

CH-11
150 mm

CH-12
150 mm

CH-13
150 mm

CH-14
145 mm

Raspatorien

Periosteal Raspatories

Periostotomi - Raspatori

Periostotomos - Legras

Rugines à périostomie

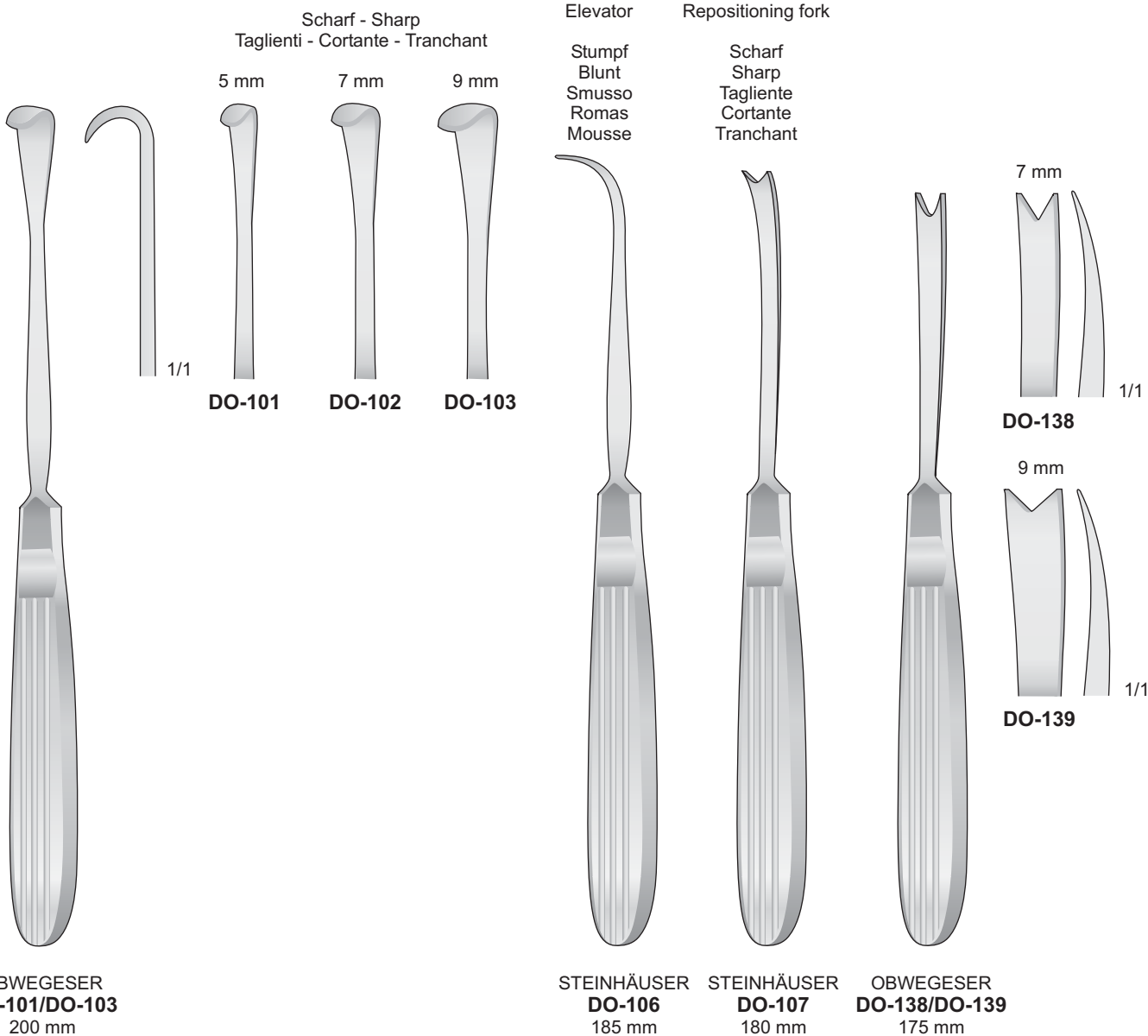

Raspatorien

Periosteal Raspatories

Periostotomi - Raspatori

Periostotomos - Legras

Rugines à périostomie

15 mm

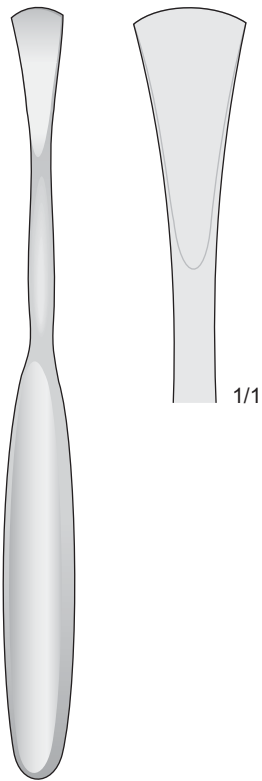

CUSHING
FK-252
190 mm

8 mm

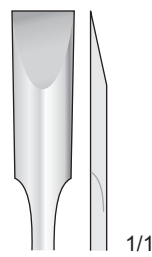

FK-260

7 mm

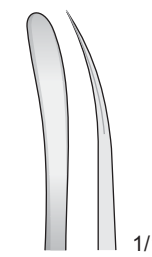

FK-261

7 mm

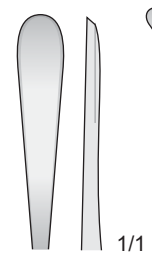

FK-262

7 mm

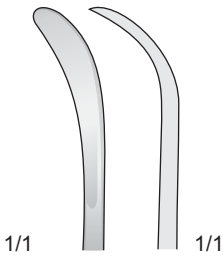

FK-263

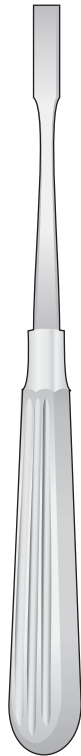

ADSON
FK-260/FK-263
170 mm

2,5 mm

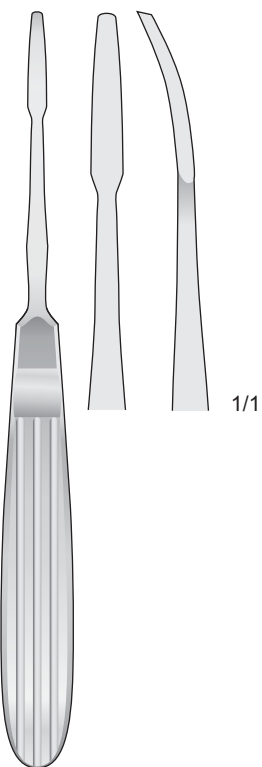

JOSEPH
FK-80
170 mm

7 mm

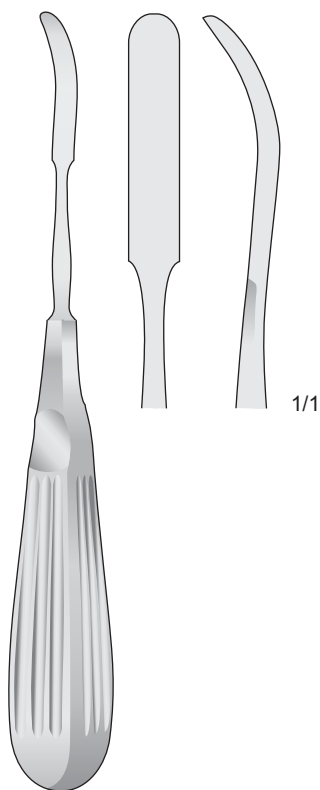

JOSEPH
FK-82
180 mm

10 mm



MOLT
MO-15
160 mm

10 mm

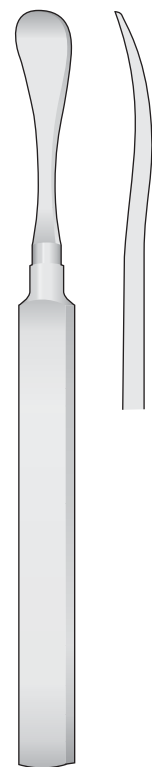

HENAHAN
BT-05/BT-07
175 mm

12 mm

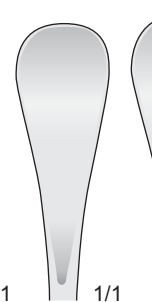

BT-06

15 mm

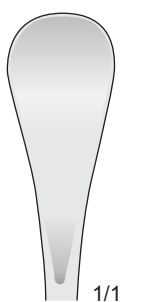

BT-07

Raspatorien

Periosteal Raspatories

Periostotomi - Raspatori

Periostotomos - Legras

Rugines à périostomie

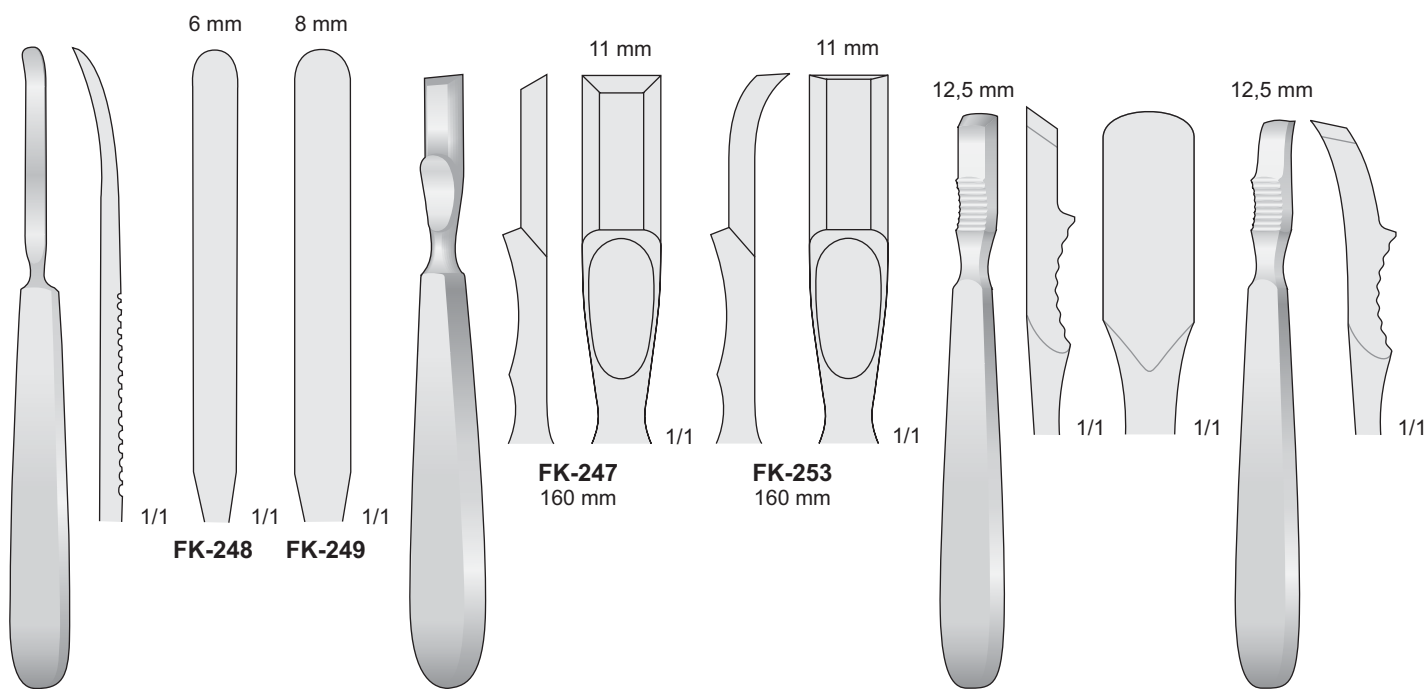

FK-248 FK-249

FK-247
160 mm

FK-253
160 mm

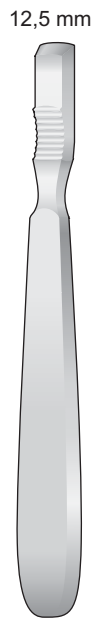

FARABEUF
FK-250
150 mm

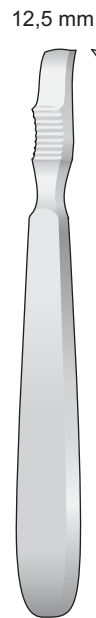

FARABEUF
FK-251
150 mm

FK-248/FK-249
170 mm

FARABEUF-COLLIN
FK-247/FK-253
160 mm

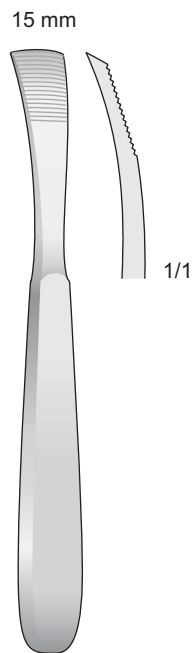

JANSEN
FK-255
165 mm

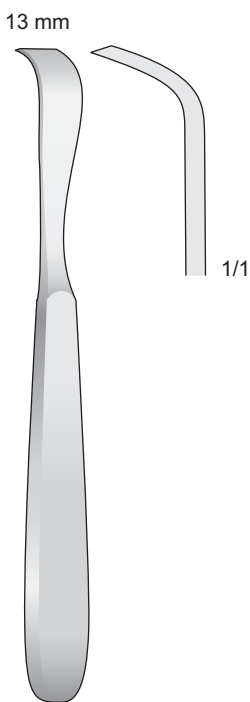

SCHNEIDER
FK-258
175 mm

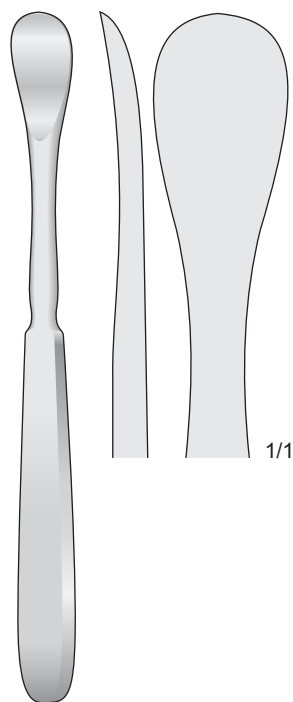

SEDILLOT
FK-254
185 mm

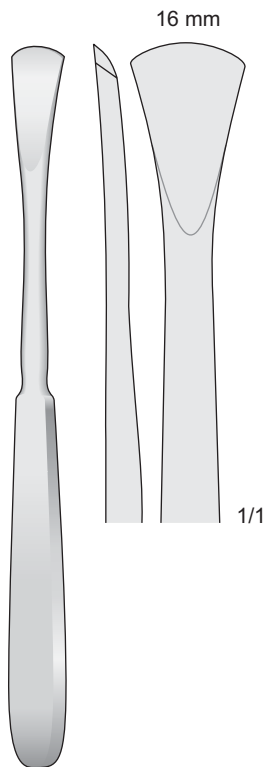

LANGENBECK
FK-256
190 mm

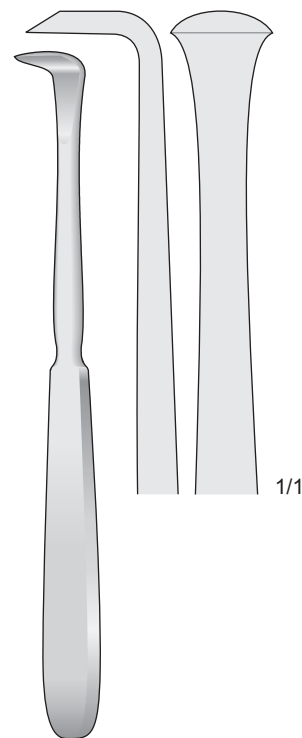

LANGENBECK
FK-257
180 mm

Osteotome

Osteotomes

Osteotomi

Osteòtomos

Ostèotomes

Septummeißel
Septum Chisels
Scalpell per il setto nasale
Cinceles para tabique nasal
Ciseaux-Burins pour la cloison nasale

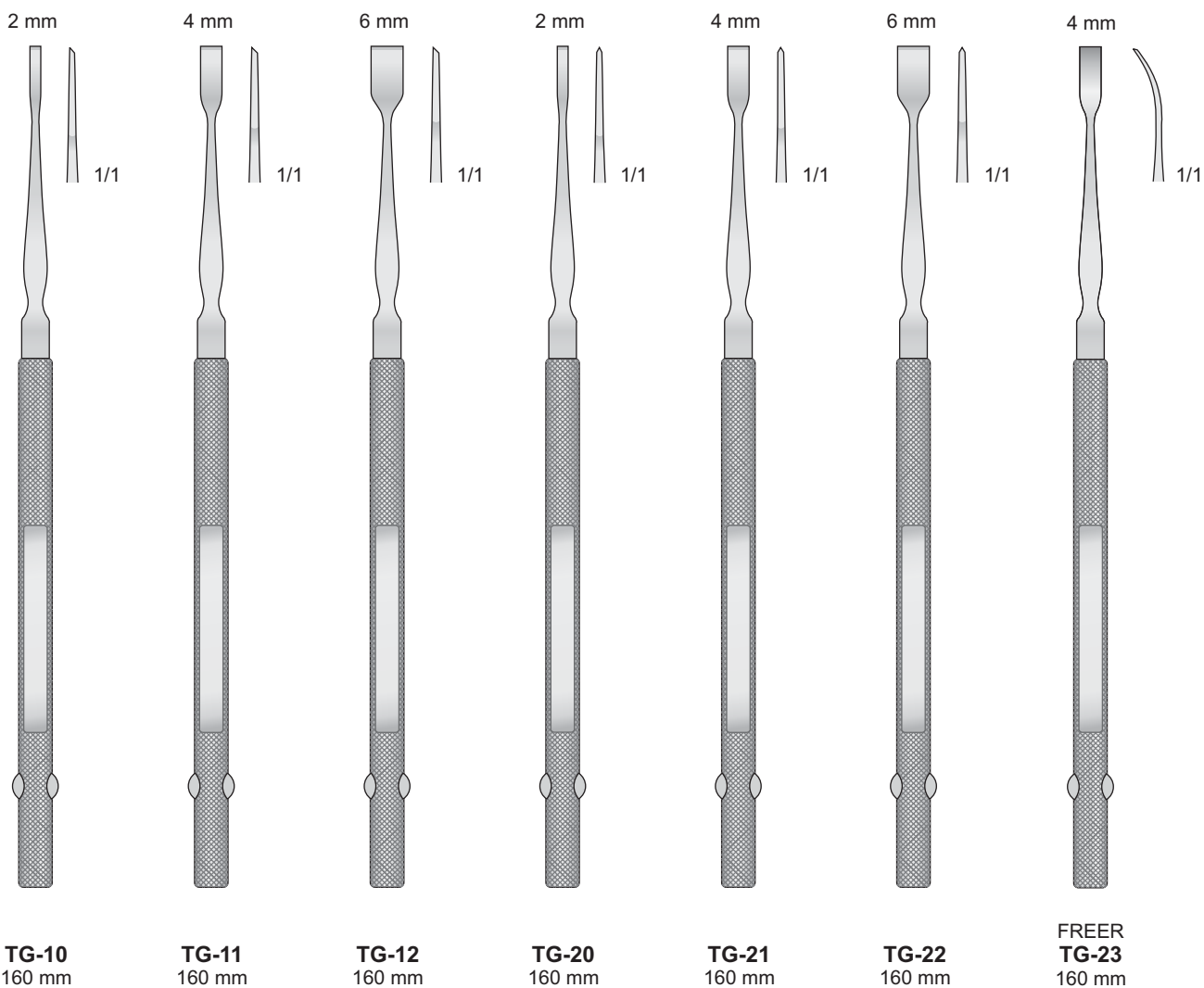

Osteotome

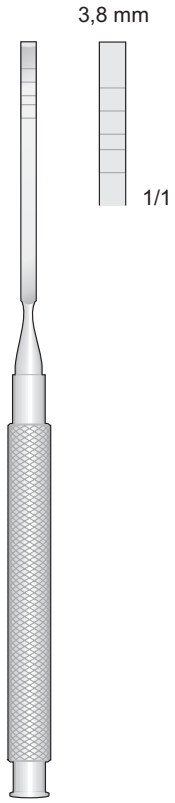

FL-141
170 mm

Osteotomes

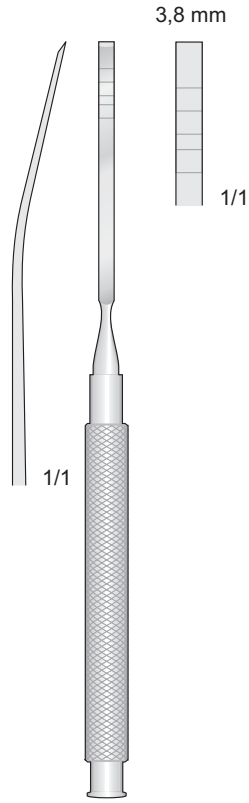

FL-142
170 mm

Osteotomi

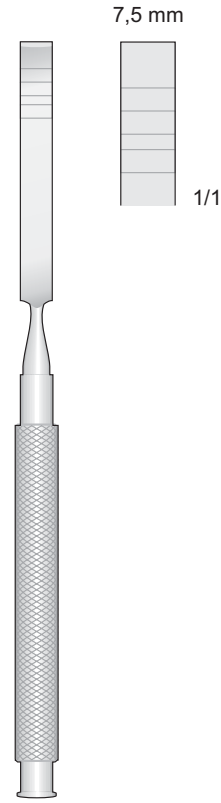

FL-143
170 mm

Osteòtomos

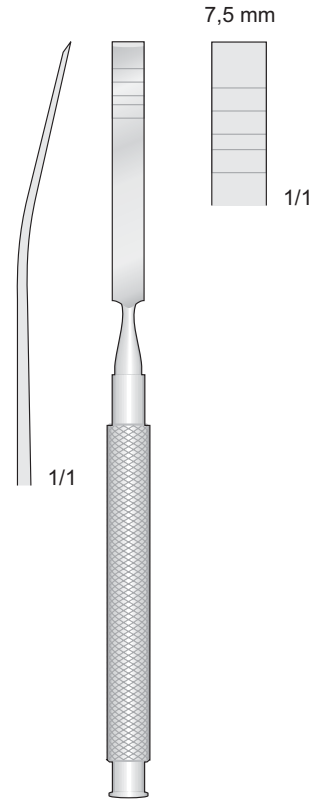

FL-144
170 mm

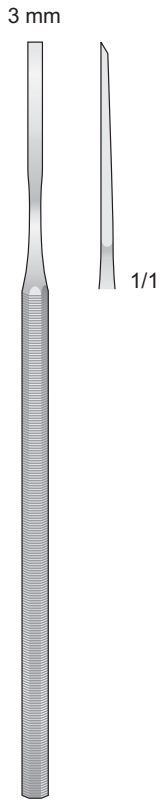

TG-30
155 mm

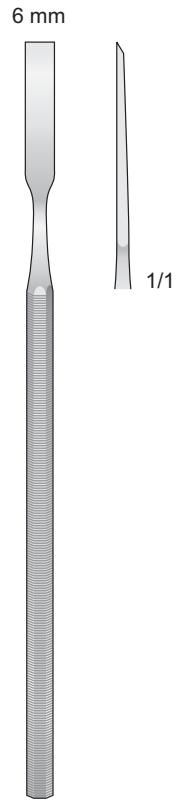

TG-31
155 mm

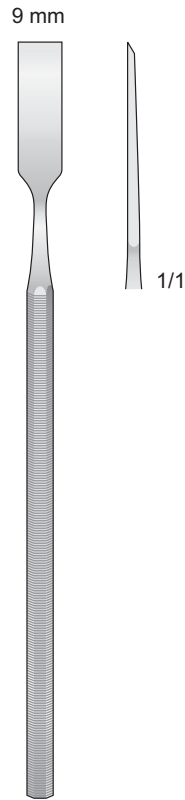

TG-32
155 mm

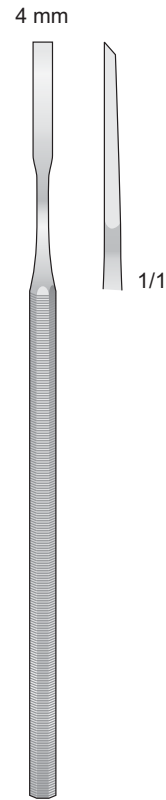

BUCKLEY
TG-40
160 mm

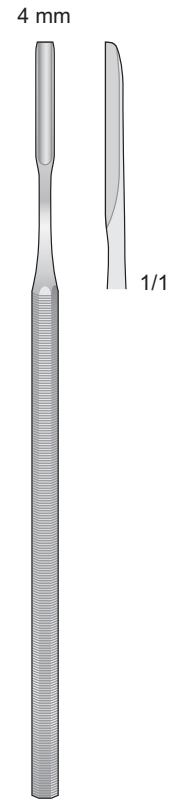

BUCKLEY
TG-41
160 mm

Osteotome

Osteotomes

Osteotomi

Osteòtomos

Ostèotomes

Septum-Hohlmeißel
Septum Gouges
Sgorbie per il setto nasale
Gubias para el tabique nasal
Gouges pour la cloison nasale

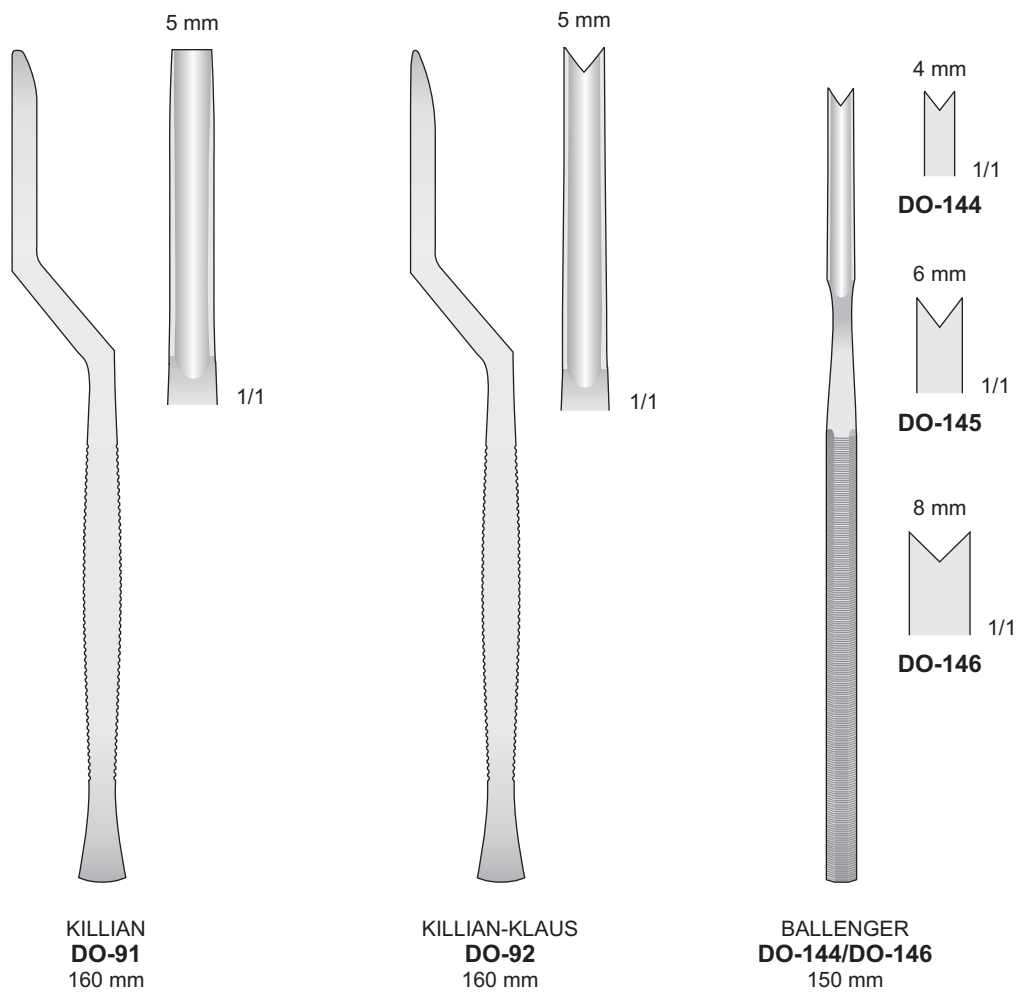

Osteotome

Osteotomes

Osteotomi

Osteòtomos

Ostèotomes

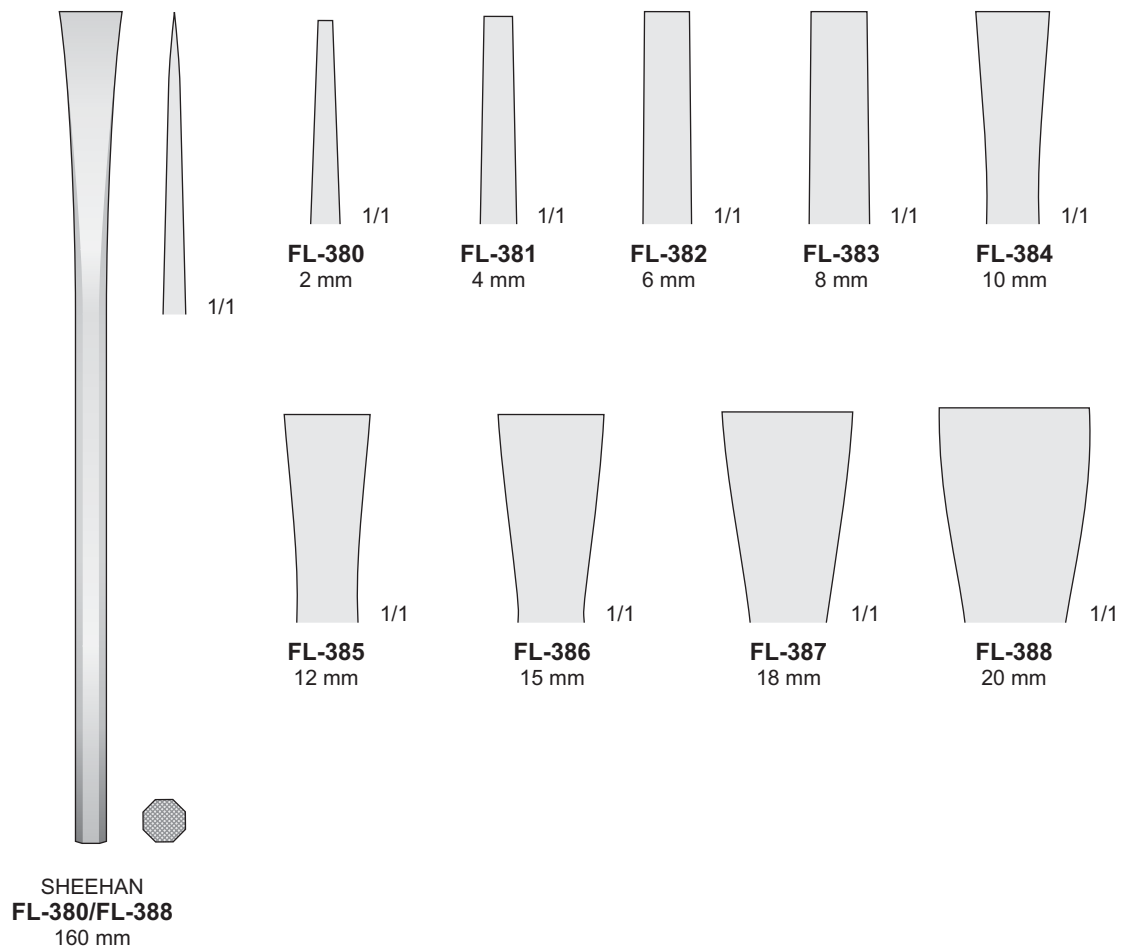

Osteotome-Hohlmeissel

Osteotomes - Gouges

Osteotomi - Scalpelli

Osteótomos - Cinceles

Ostéotomes - Scalpel

Osteotome -Osteotomes
Osteotomi - Osteótomos - Ostéotomes

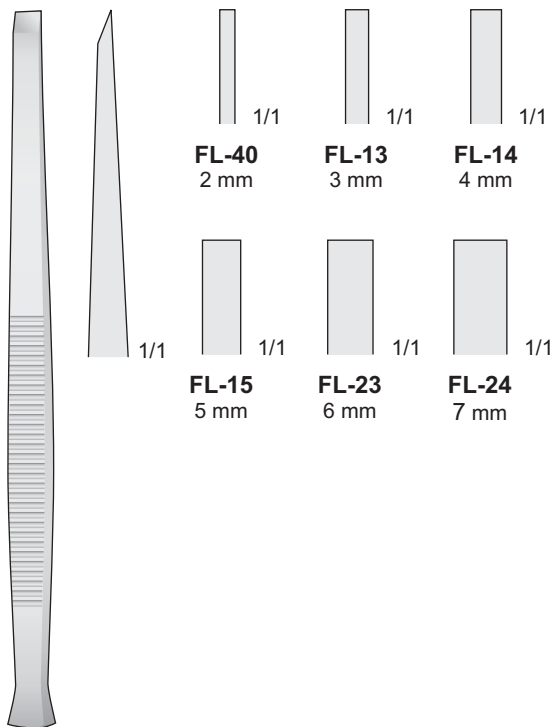

PARTSCH
FL-13/FL-40
140 mm

Hohlmeissel - Gouges
Sgorbie - Gubias - Gouges

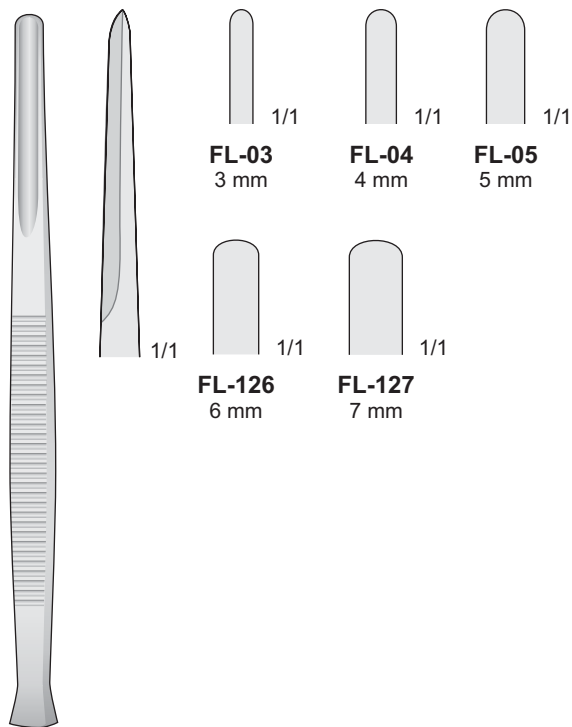

PARTSCH
FL-03/FL-127
140 mm

Osteotome -Osteotomes
Osteotomi - Osteótomos - Ostéotomes

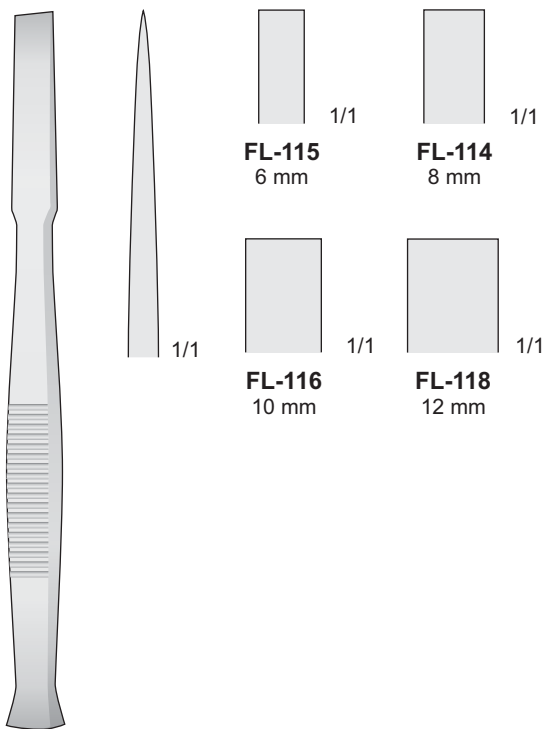

FL-114/FL-118
140 mm

Hohlmeissel - Gouges
Sgorbie - Gubias - Gouges

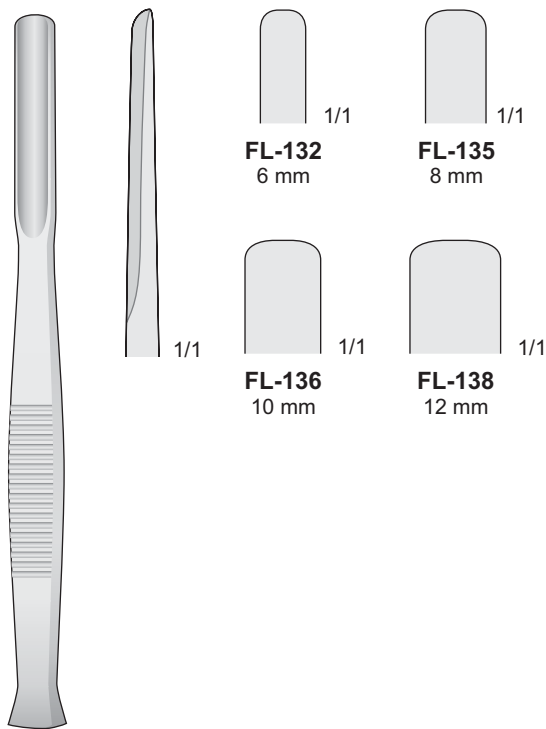

FL-132/FL-138
140 mm

Flachmeißel



WEST
FL-133
160 mm

Hohlmeißel



WEST
FL-134
160 mm



PARTSCH
FL-177/FL-181
170 mm

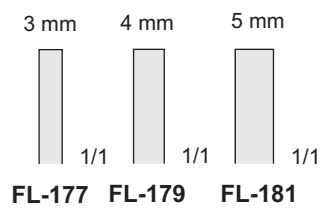

PARTSCH
FL-185/FL-187
170 mm

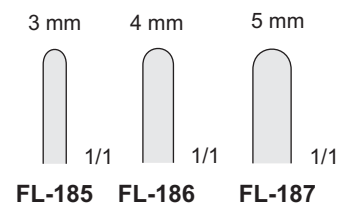
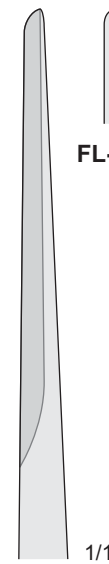

Osteotome

Osteotomes

Osteotomi

Osteòtomos

Ostèotomes

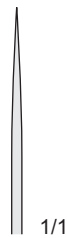

1/1

3 mm



1/1

FL-53

4 mm



1/1

FL-16

6 mm



1/1

FL-17

8 mm

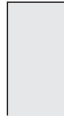

1/1

FL-18

10 mm

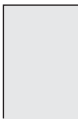

1/1

FL-32

12 mm

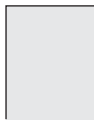

1/1

FL-54

15 mm



1/1

FL-58

MINI-LAMBOTTE
FL-16/FL-58
125 mm

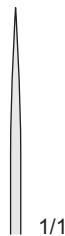

1/1

3 mm



1/1

FL-263

4 mm



1/1

FL-264

6 mm



1/1

FL-265

8 mm

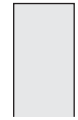

1/1

FL-266

10 mm

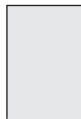

1/1

FL-267

12 mm



1/1

FL-268

15 mm



1/1

FL-269

MINI-LAMBOTTE
FL-263/FL-269
170 mm

Osteotome

Osteotomes

Osteotomi

Osteòtomos

Ostèotomes

4 mm

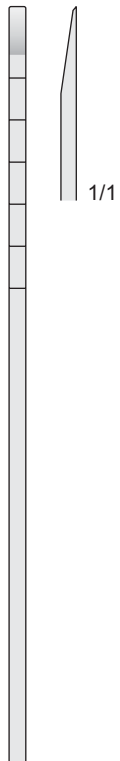

**COTTLE
DO-130**
180 mm

7 mm



**COTTLE
DO-131**
180 mm

9 mm



**COTTLE
DO-132**
180 mm

12 mm

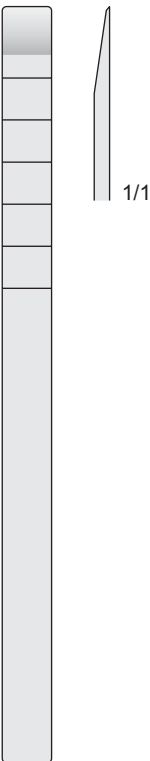

**COTTLE
DO-133**
180 mm

4 mm

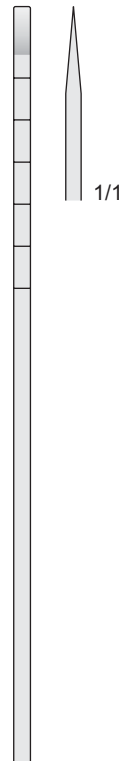

**COTTLE
DO-140**
180 mm

7 mm

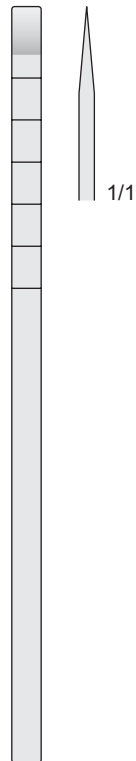

**COTTLE
DO-141**
180 mm

12 mm

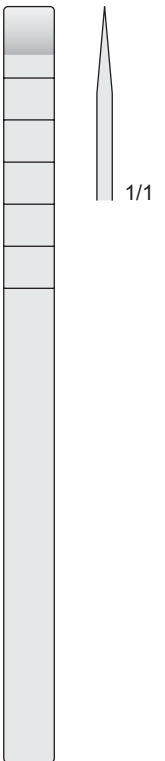

**COTTLE
DO-143**
180 mm

Osteotome

Osteotomes

Osteotomi

Osteòtomos

Ostèotomes

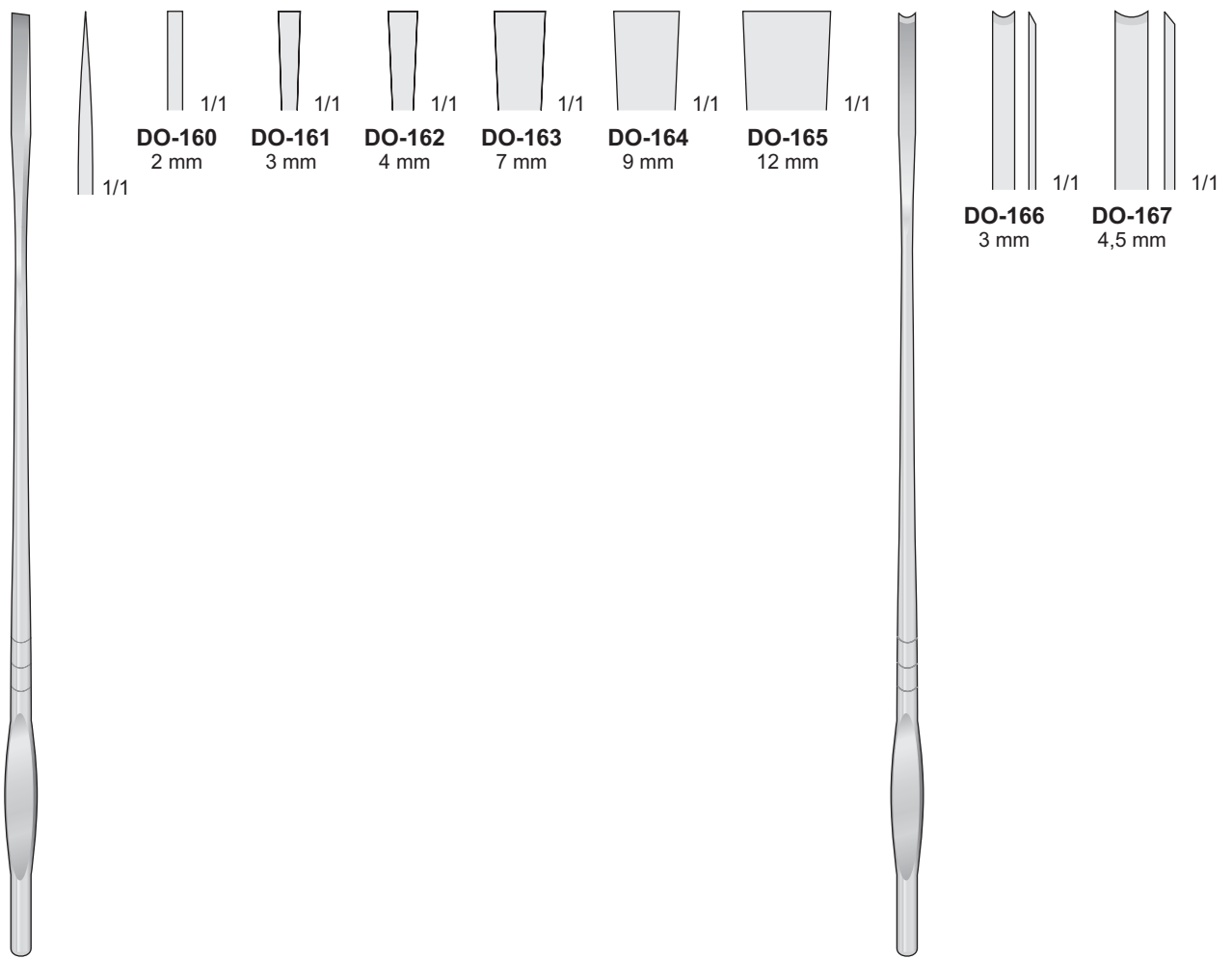

WALTER
DO-160/DO-165
190 mm

WALTER
DO-166/DO-167
190 mm

Rhinologie

Rhinology

Rinologia

Rinologia

Rhinologie

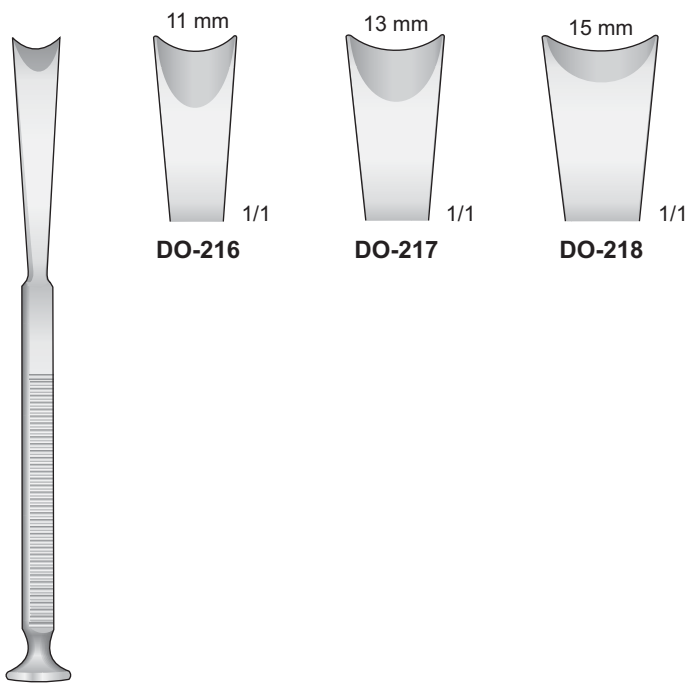

McINDOE
DO-216/DO-218
145 mm



FAULKNER
DO-173
170 mm

Meißel zur endonasalen
Kieferhöhlenöffnung
Antrum Trocar chisel
Sgorbia per l'apertura endonasale
della cavità mascellare
Cinzel para la apertura
endonasal del seno maxilar
Gouge pour l'ouverture de la cavité
endonasale pour sinus maxillaire

Gerade - Straight
Diritto - Rectas
Droites

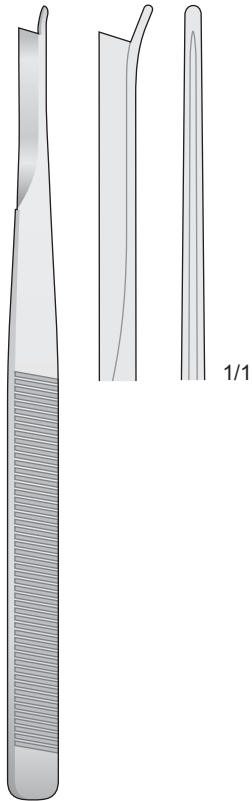

SILVER
DO-34
180 mm

Links - Left
Sinistra - Izquierda
Gauche

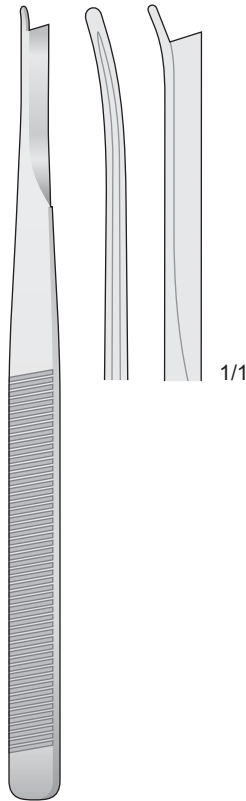

SILVER
DO-35
180 mm

Rechts - Right
Destra - Derecha
Droite

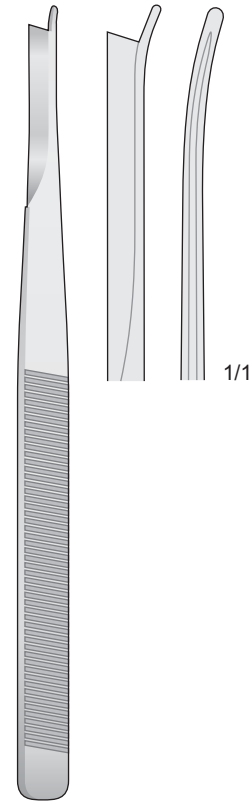

SILVER
DO-36
180 mm

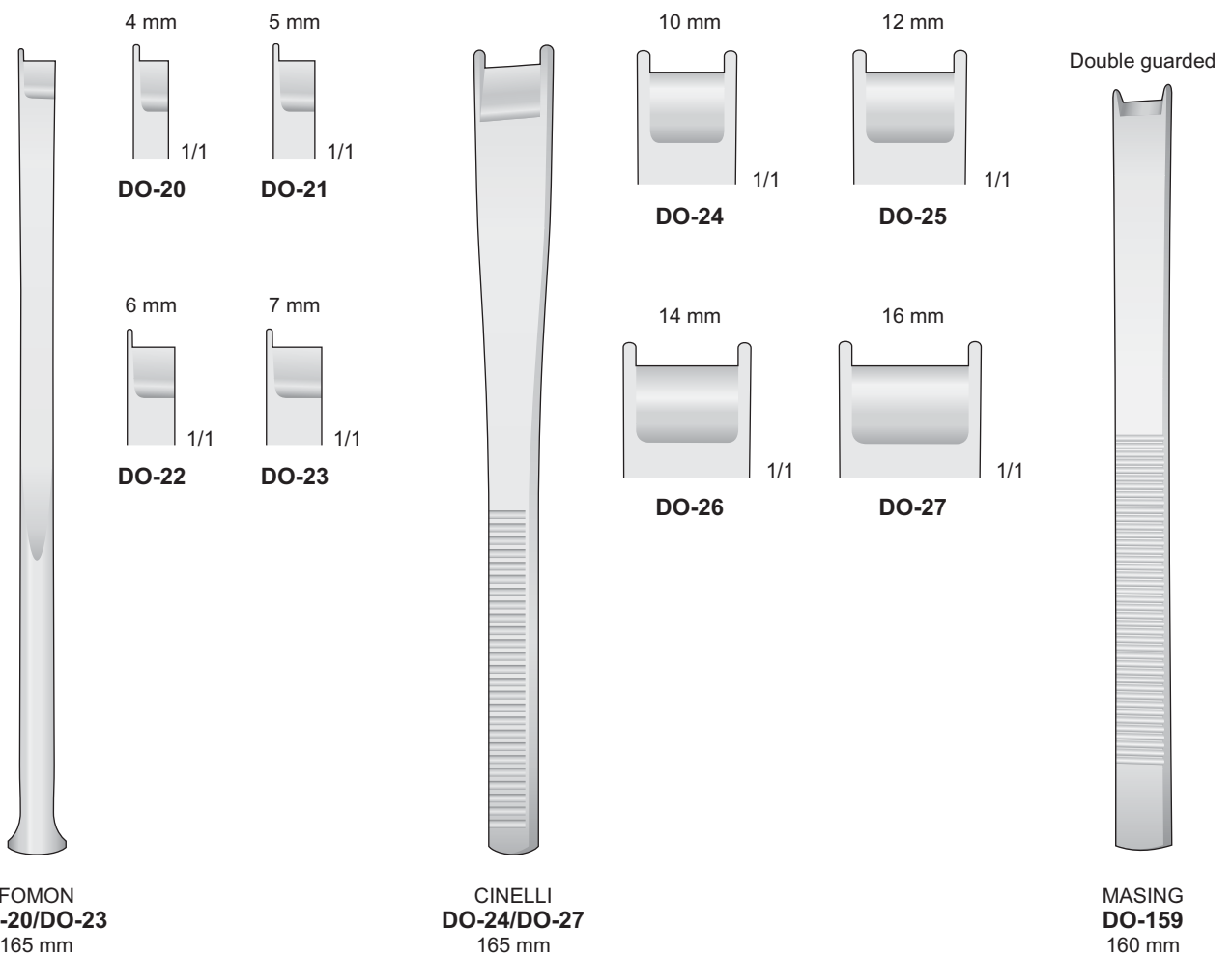

Rhinologie

Rhinology

Rinologia

Rinologia

Rhinologie

4.0 mm

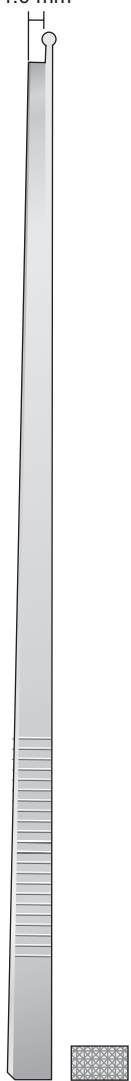

DO-118
200 mm

6.0 mm

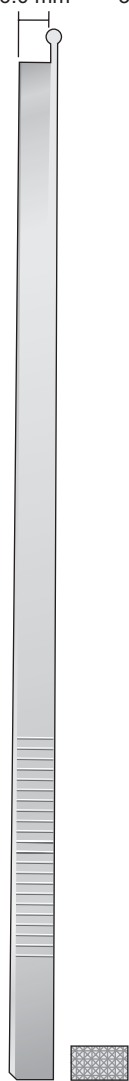

DO-119
200 mm

3.0 mm

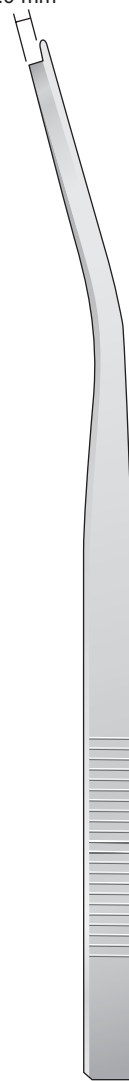

DO-84
200 mm

6.0 mm



DO-85
200 mm

Osteotome, Osteotomes
Osteotomi, Osteótomos, Osteótomes

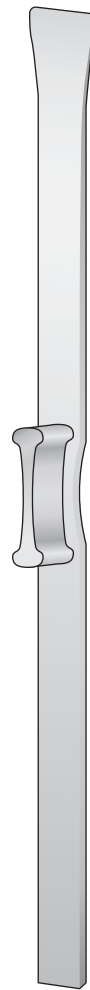

RUBIN
DO-170/DO-172
180 mm



DO-170
10 mm



DO-171
12 mm



DO-172
14 mm

Osteotome

Osteotomes

Osteotomi

Osteòtomos

Ostèotomes

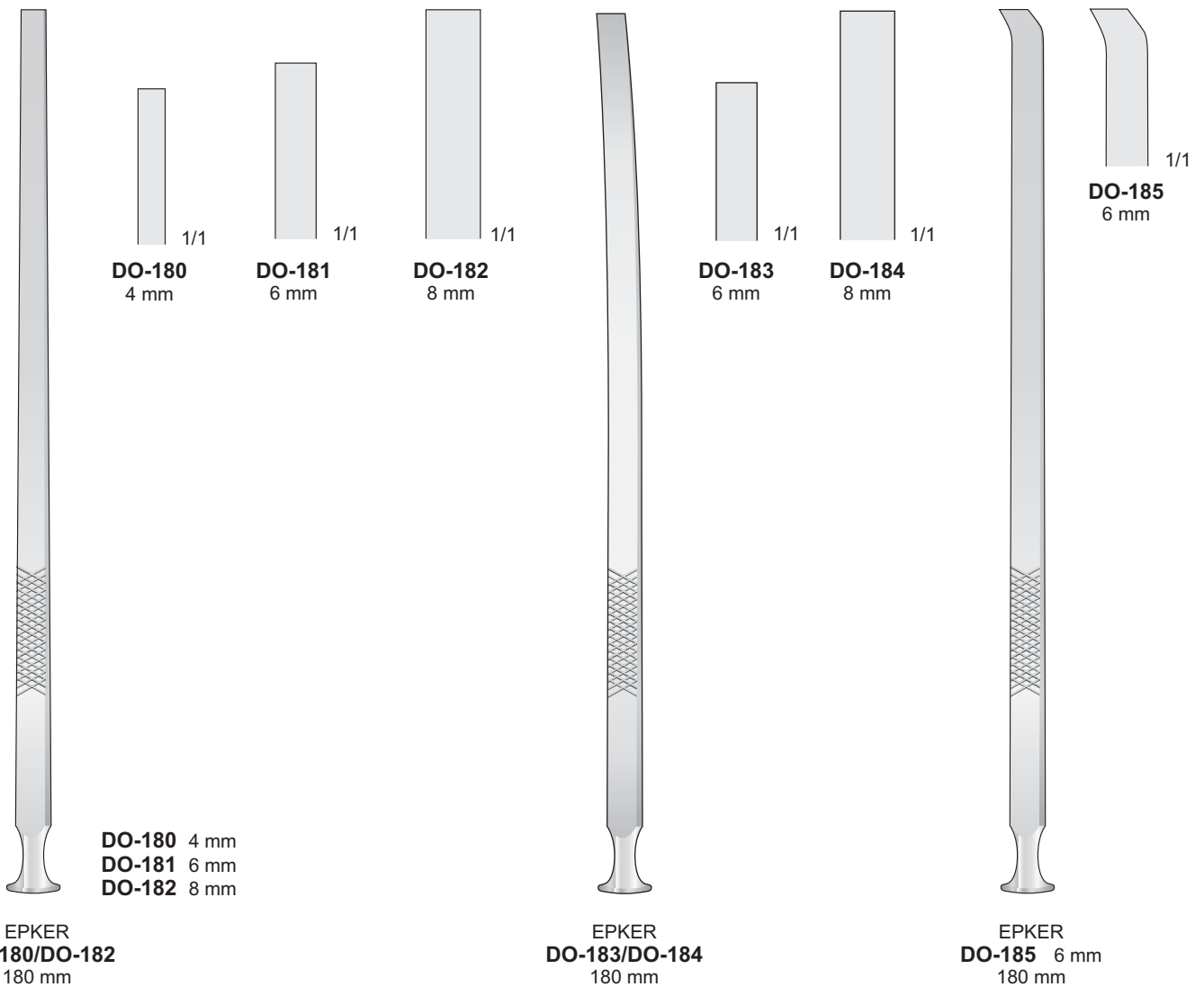

Osteotome

Osteotomes

Osteotomi

Osteòtomos

Ostèotomes

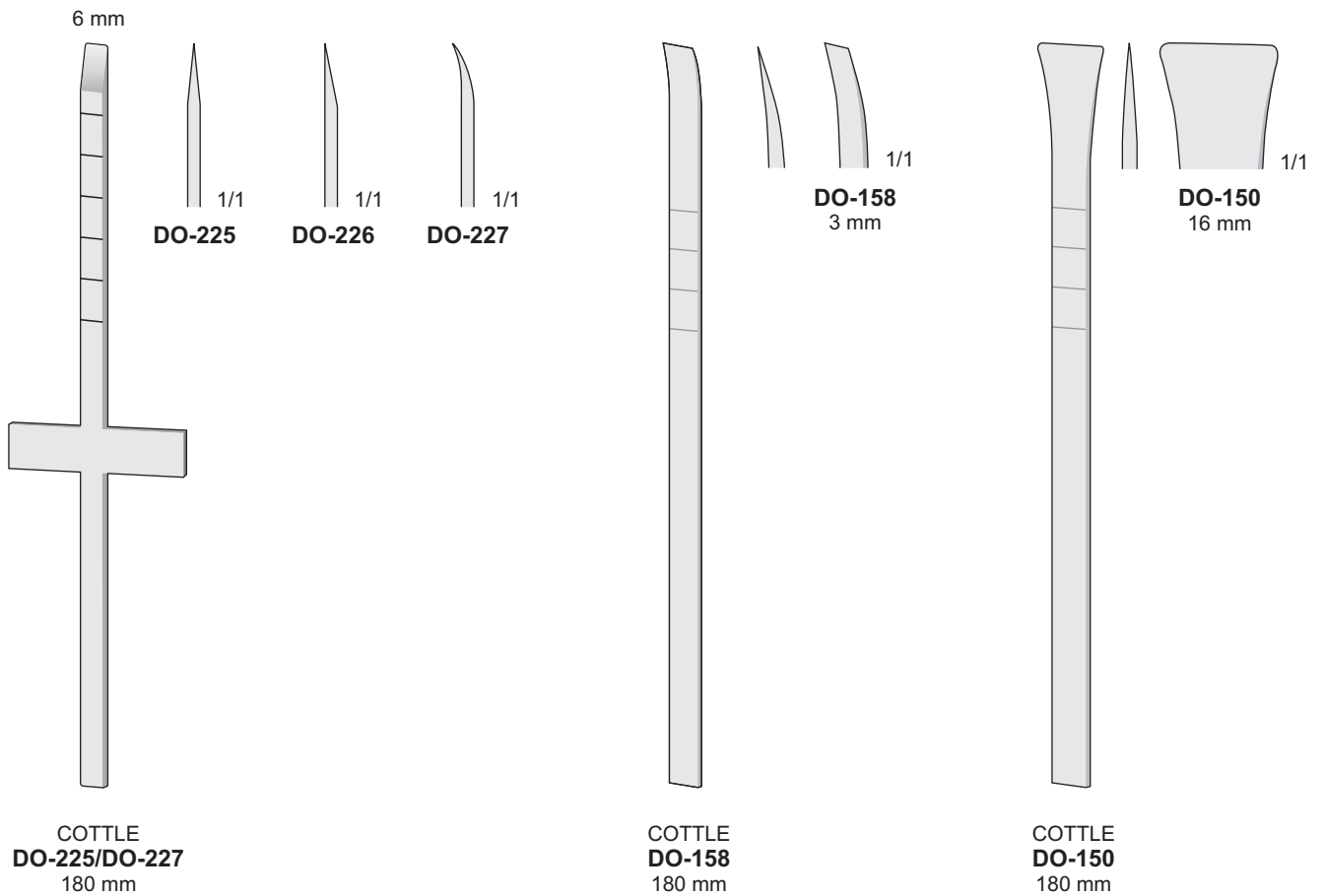

Osteotome

Osteotomes

Osteotomi

Osteòtomos

Ostèotomes

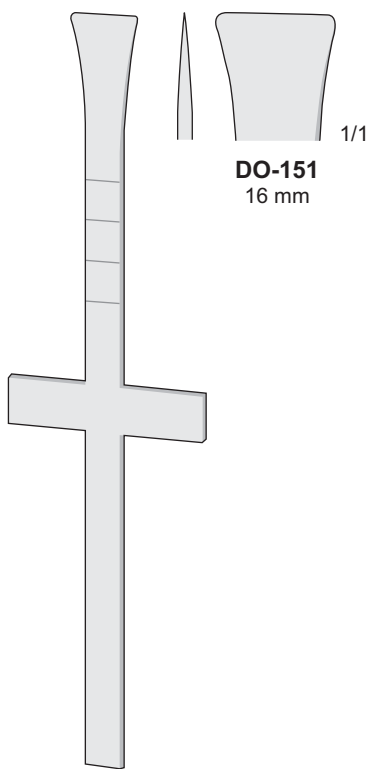

DO-151
16 mm

COTTLE
DO-151
180 mm

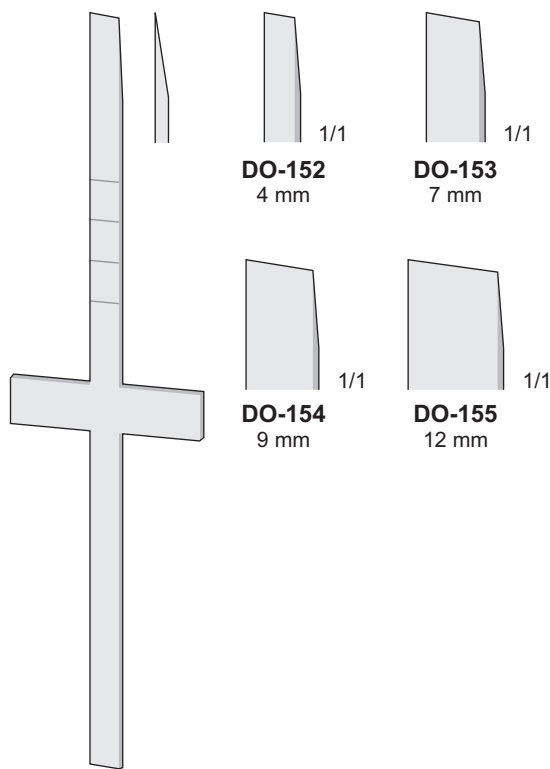

DO-152
4 mm

DO-154
9 mm

DO-153
7 mm

DO-155
12 mm

COTTLE
DO-152/DO-155
180 mm

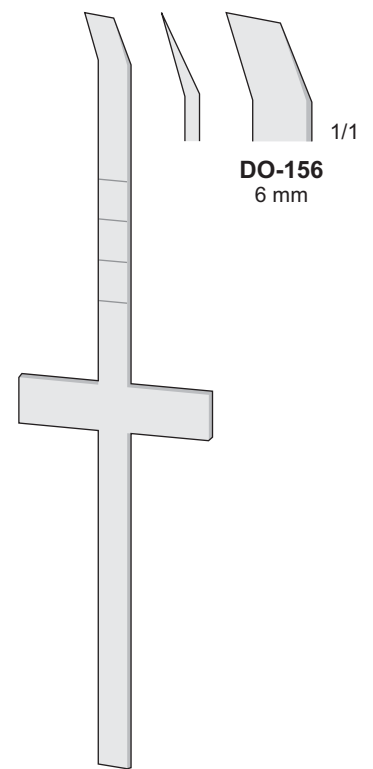

DO-156
6 mm

COTTLE
DO-156
180 mm

Schwingmesser
Swivel Knife
Coltello per setto con lama girevole
Cuchilo para el tabique nasal
Couteau pour la cloison nasale

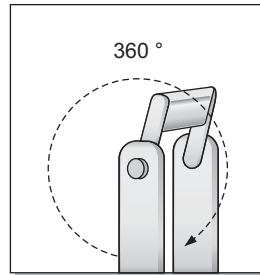

BALLENGER
DO-50/DO-52
200 mm



DO-50
3 mm



DO-51
4 mm

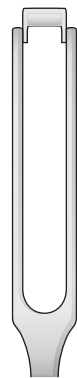

DO-52
5 mm



BALLENGER
DO-53/DO-55
200 mm



DO-53
3 mm



DO-54
4 mm



DO-55
5 mm

Osteotome

Osteotomes

Osteotomi

Osteòtomos

Ostèotomes

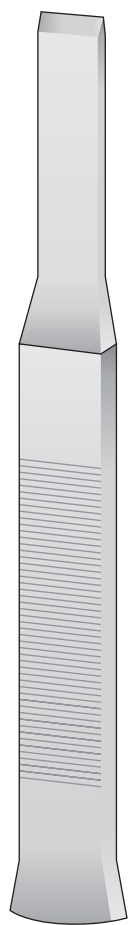

FL-401
10 mm
FL-402
14 mm
FL-403
18 mm

TESSIER
FL-401/FL-403
160 mm

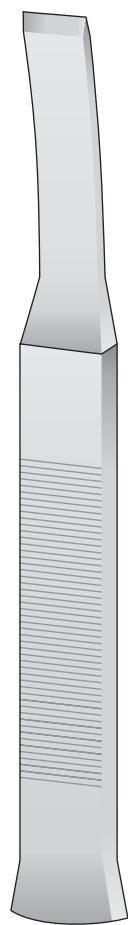

TESSIER
FL-404 10 mm
160 mm

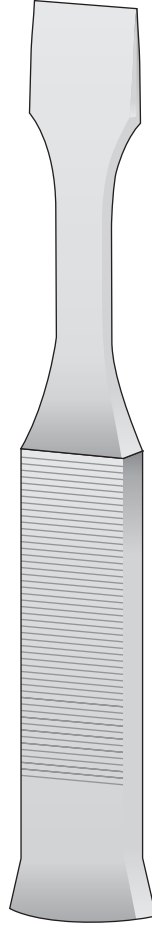

TESSIER
FL-405 18 mm
160 mm

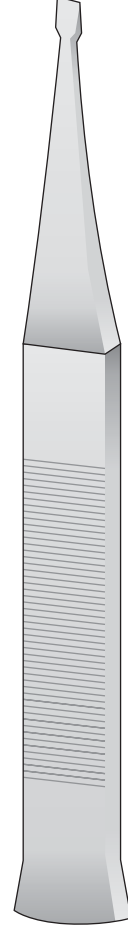

TESSIER
FL-410 3,5 mm
160 mm

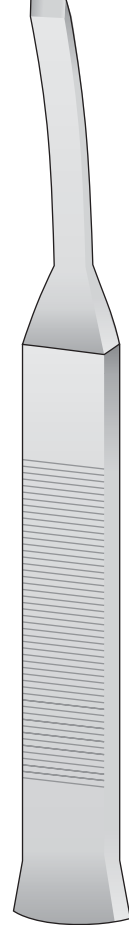

TESSIER
FL-411/FL-412
160 mm

FL-411
5 mm
FL-412
7 mm

Osteotome

Osteotomes

Osteotomi

Osteòtomos

Ostèotomes

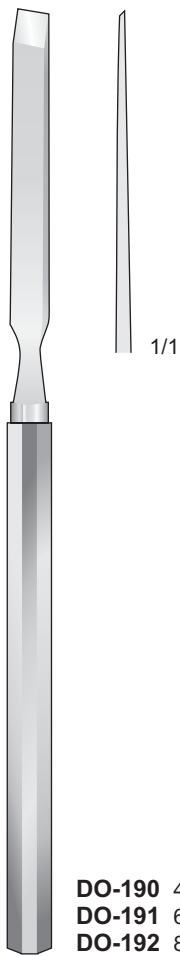

DO-190/DO-192
180 mm

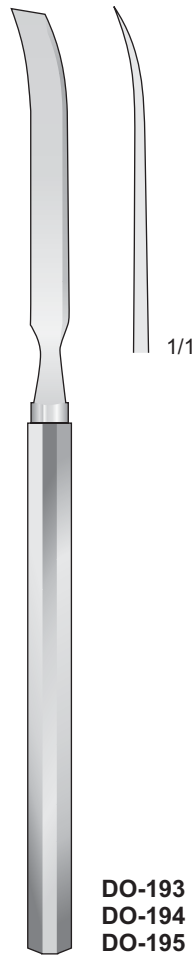

DO-193/DO-195
180 mm

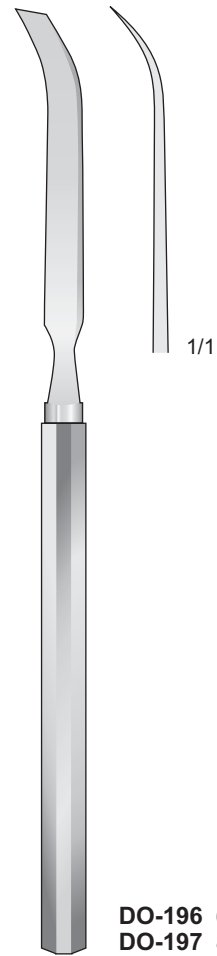

DO-196/DO-197
180 mm

Osteotome

Osteotomes

Osteotomi

Osteòtomos

Ostèotomes

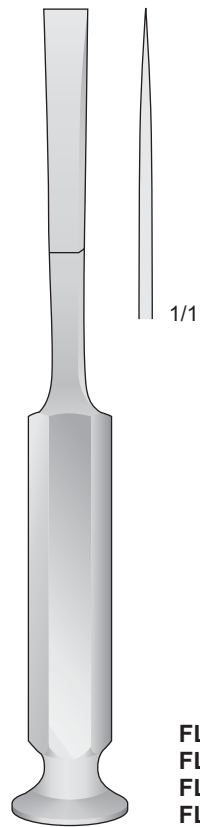

TESSIER
FL-307/FL-310
200 mm

- FL-307 10 mm
- FL-308 15 mm
- FL-309 20 mm
- FL-310 30 mm

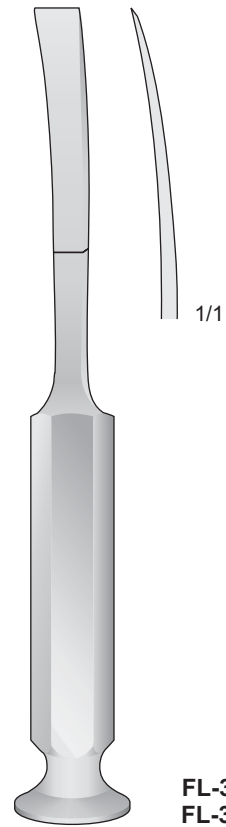

TESSIER
FL-311/FL-312
200 mm

- FL-311 10 mm
- FL-312 15 mm

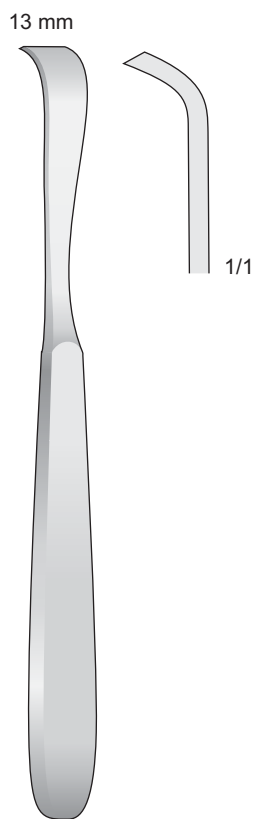

SCHNEIDER-SAUERBRUCH
FK-259
190 mm

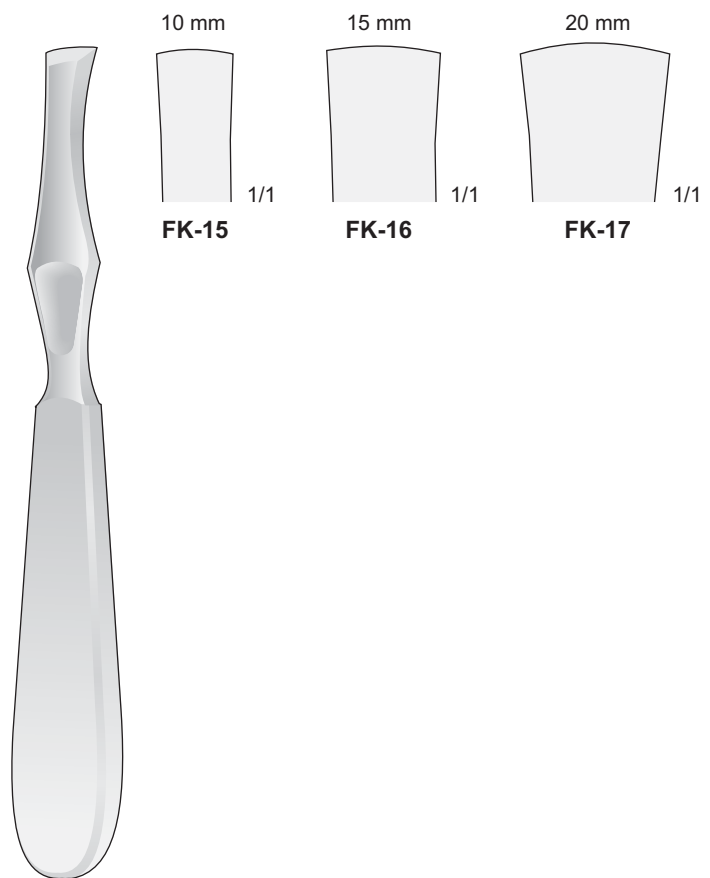

LAMBOTTE
FK-15/FK-17
205 mm

Raspatorien

Periosteal Raspatories

Periostotomi - Raspatori

Periostotomos - Legras

Rugines à périostomie

Mit Ferrozellgriff
With Ferrozell handle
Con manico Ferrozell
Con mango de Ferrozell
Avec poignée en Ferrozell

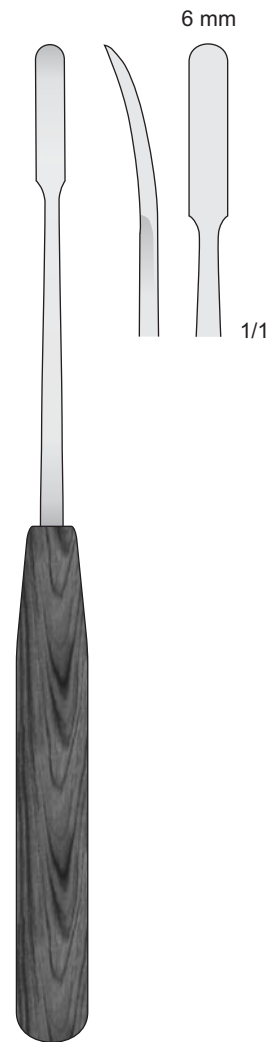
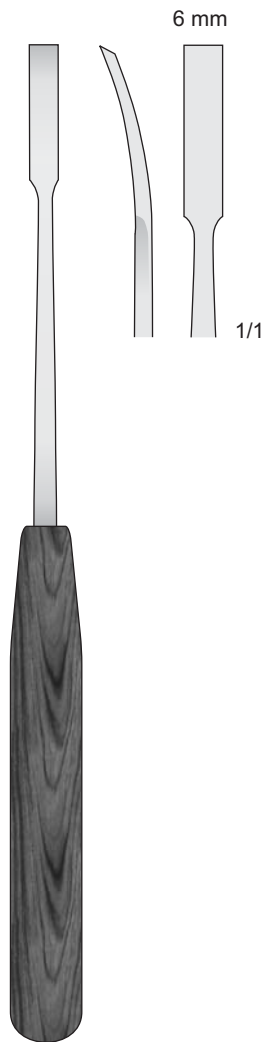
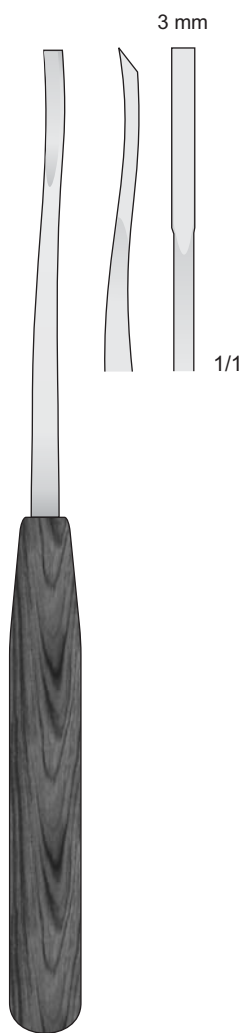

Osteotome

Osteotomes

Osteotomi

Osteòtomos

Ostèotomes

Mit Ferrozellgriff
With Ferrozell handle
Con manico Ferrozell
Con mango de Ferrozell
Avec poignée en Ferrozell

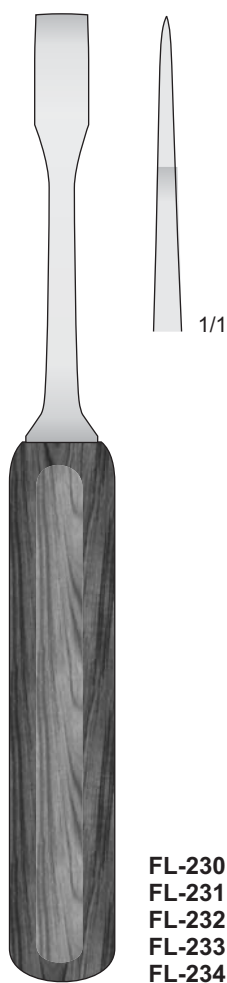

MINI-LEXER
FL-230/FL-234
180 mm

- FL-230 4 mm
- FL-231 6 mm
- FL-232 8 mm
- FL-233 10 mm
- FL-234 12 mm

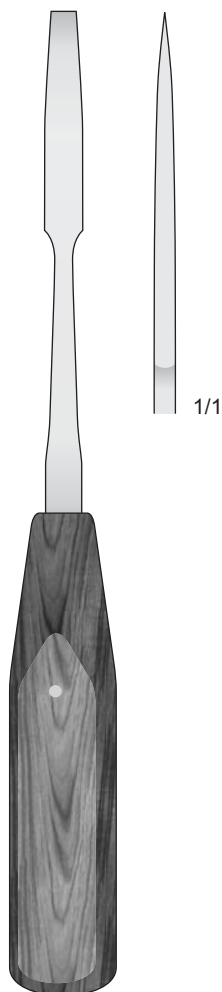

MINI-LEXER
FL-59/FL-62
200 mm

- | | |
|----------------------|----------------------|
| 2 mm
FL-59
1/1 | 4 mm
FL-60
1/1 |
| 6 mm
FL-61
1/1 | 8 mm
FL-62
1/1 |

Osteotome

Osteotomes

Osteotomi

Osteòtomos

Ostèotomes

Mit Ferrozellgriff
With Ferrozell handle
Con manico Ferrozell
Con mango de Ferrozell
Avec poignée en Ferrozell

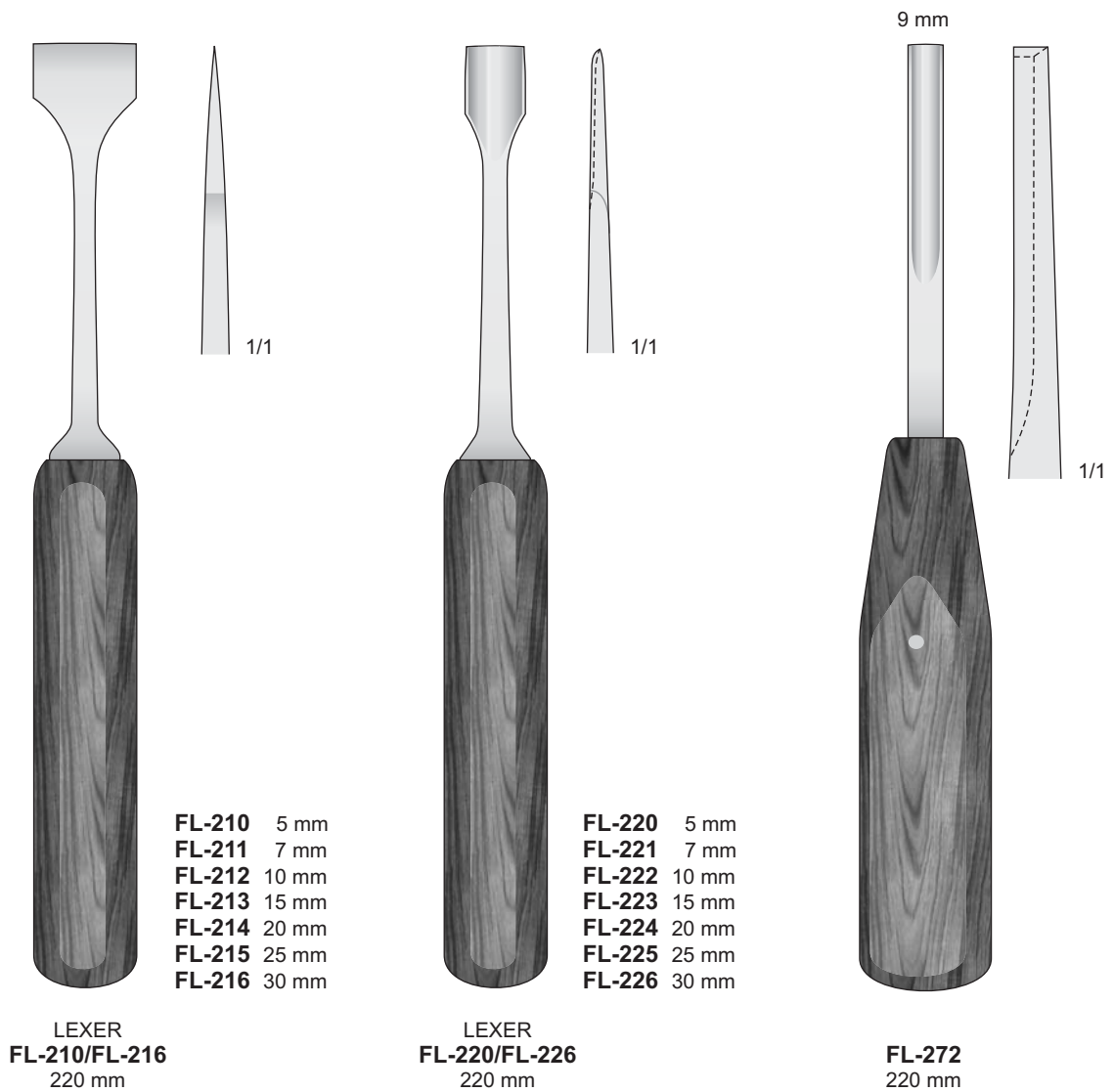

Osteotome

Osteotomes

Osteotomi

Osteòtomos

Ostèotomes

Mit Ferrozellgriff
With Ferrozell handle
Con manico Ferrozell
Con mango de Ferrozell
Avec poignée en Ferrozell

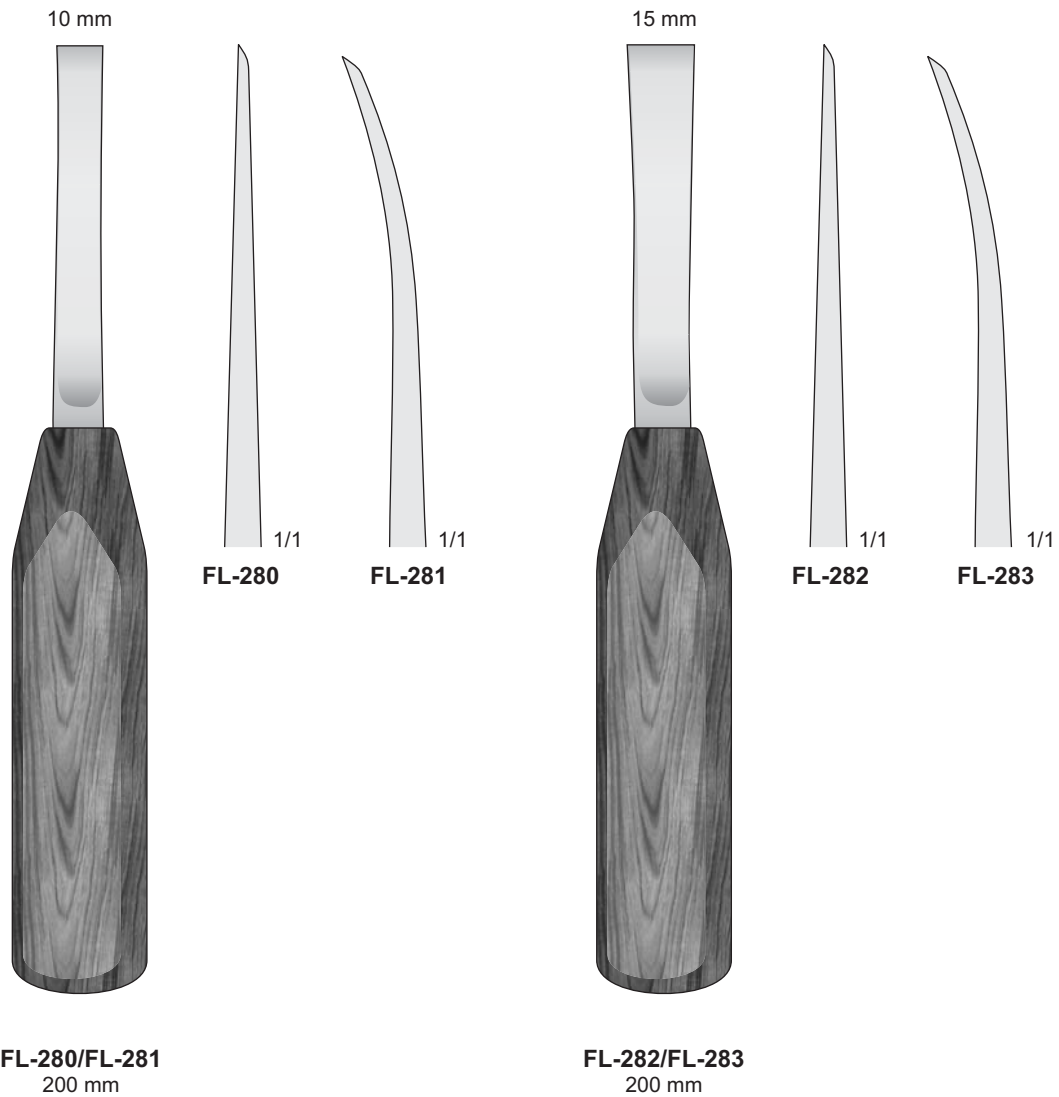

Osteotome

Osteotomes

Osteotomi

Osteòtomos

Ostèotomes

Mit Ferrozellgriff
With Ferrozell handle
Con manico Ferrozell
Con mango de Ferrozell
Avec poignée en Ferrozell

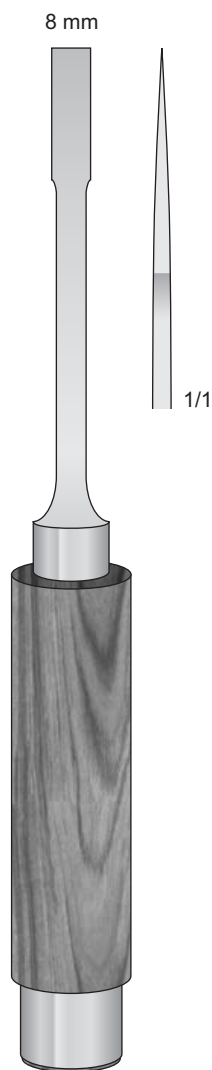

OBWEGESER
FL-334
220 mm

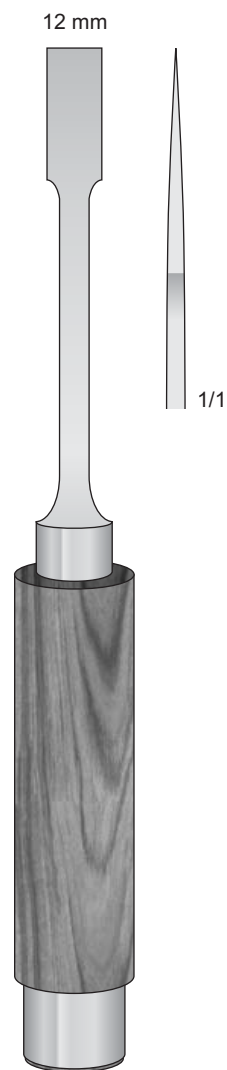

OBWEGESER
FL-335
220 mm

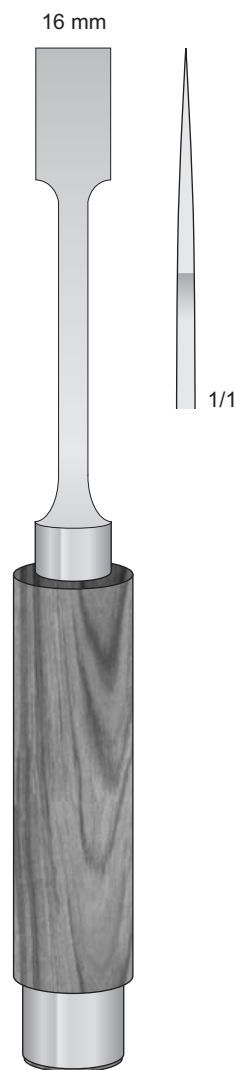

OBWEGESER
FL-336
220 mm

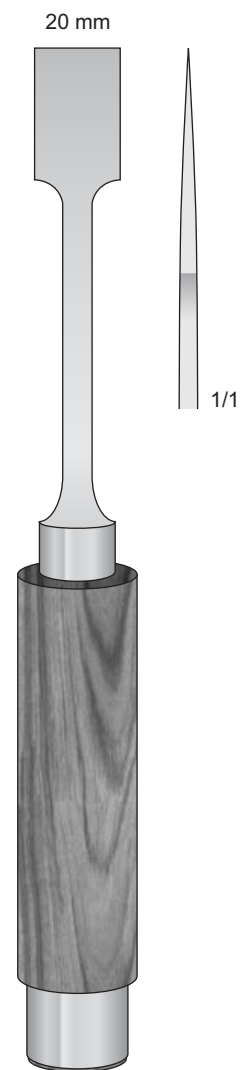

OBWEGESER
FL-337
220 mm

Chirurgische Hämmer

Surgical mallets

Martelli chirurgici

Martillos quirurgicos

Maillets chirurgicaux

Ø 25 mm - 200 g

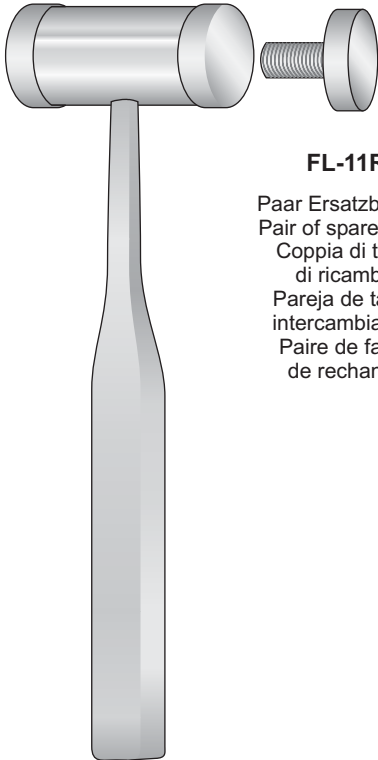

FL-11R

Paar Ersatzbacken
Pair of spare faces
Coppia di teste
di ricambio
Pareja de tapas
intercambiables
Paire de faces
de rechange

MEAD
FL-11
200 mm

Ø 20 mm - 160 g

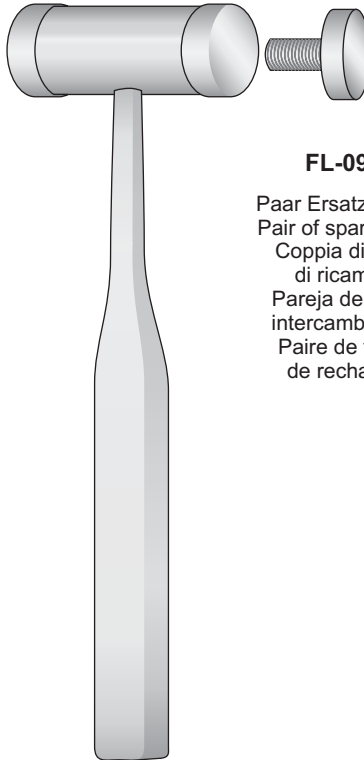

FL-09R

Paar Ersatzbacken
Pair of spare faces
Coppia di teste
di ricambio
Pareja de tapas
intercambiables
Paire de faces
de rechange

MEAD
FL-09
190 mm

Ø 26 mm - 320 g

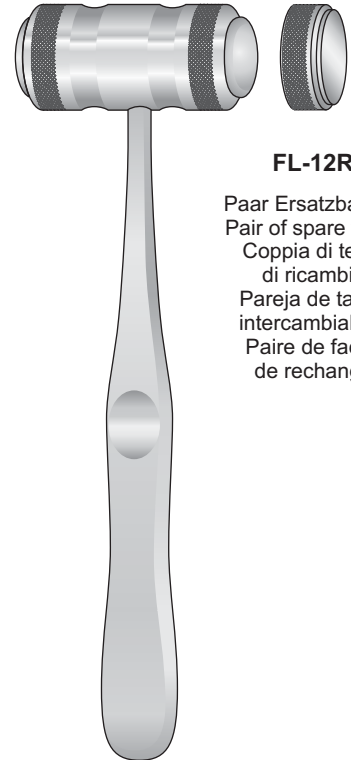

FL-12R

Paar Ersatzbacken
Pair of spare faces
Coppia di teste
di ricambio
Pareja de tapas
intercambiables
Paire de faces
de rechange

MEAD
FL-12
190 mm

Ø 20 mm - 140 g

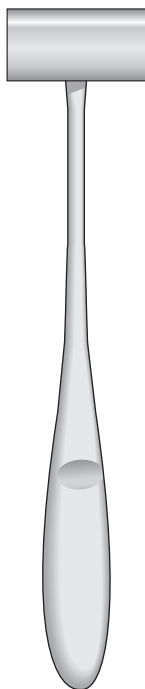

FL-01
165 mm

Ø 25 mm - 300 g

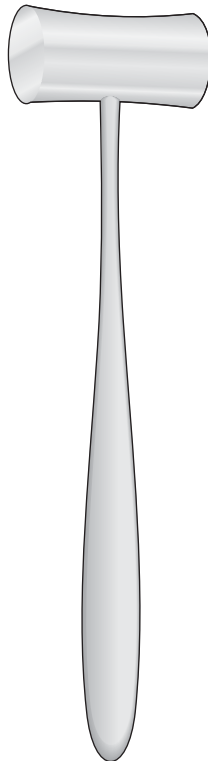

LUCAE
FL-10M
190 mm

Ø 20 mm - 240 g

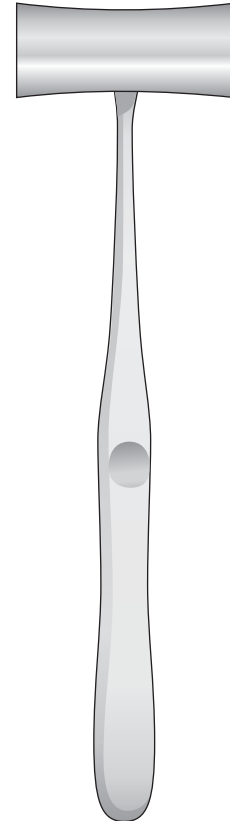

WILLIGER
FL-02
240 mm

1 Seite flach - 1 Seite convex
1 Side flat - 1 Side convex
1 Lato piatto - 1 Lato convesso
1 Parte plana - 1 Parte convexe
1 Face plate - 1 Face convexe

Ø 30 mm - 240 g

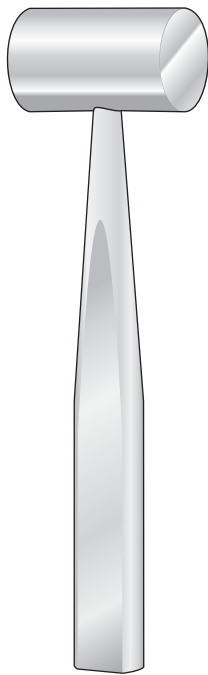

COTTLE
FL-104
185 mm

Ø 30 mm - 300 g



BERGMANN
FL-105
235 mm

Ø 40 mm - 550 g



OMBREDANNE
FL-108
240 mm

Knochenfeilen

Bone files

Lime per osso

Limas para huesos

Limes à os

Fig. 67

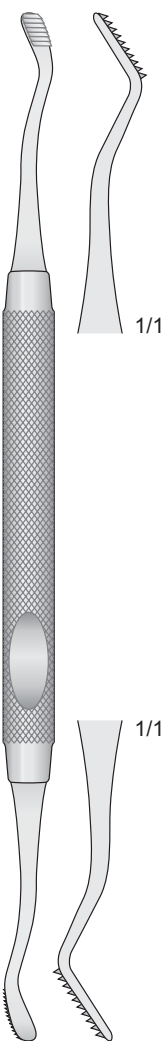

HOWARD
DO-1
180 mm

Fig. 45

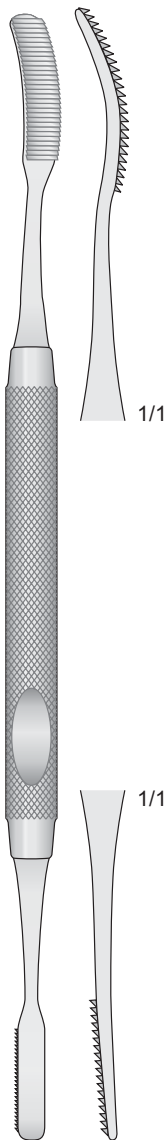

MILLER
DO-2
185 mm

Fig. 52

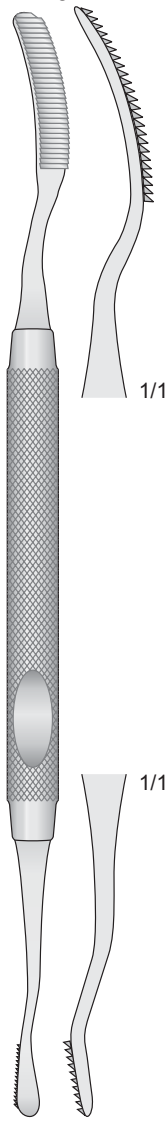

MILLER
DO-3
180 mm

Fig. 12

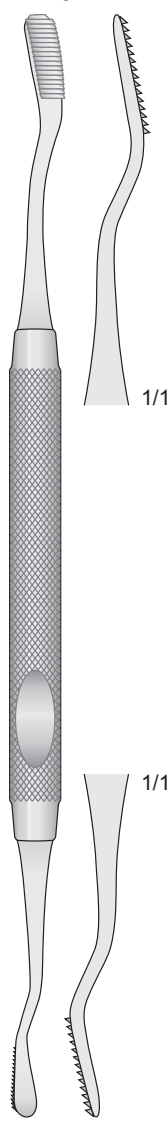

HOWARD
DO-4
170 mm

Fig. 64

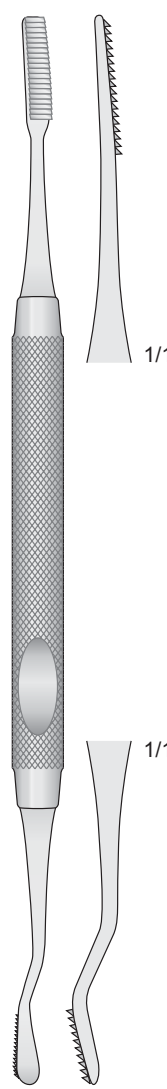

MILLER
DO-5
175 mm

Knochenfeilen

Bone files

Lime per osso

Limas para huesos

Limes à os

Nasenraspeln - Nasal Rasps
Raspe nasali - Raspadores nasales
Râpes nasales

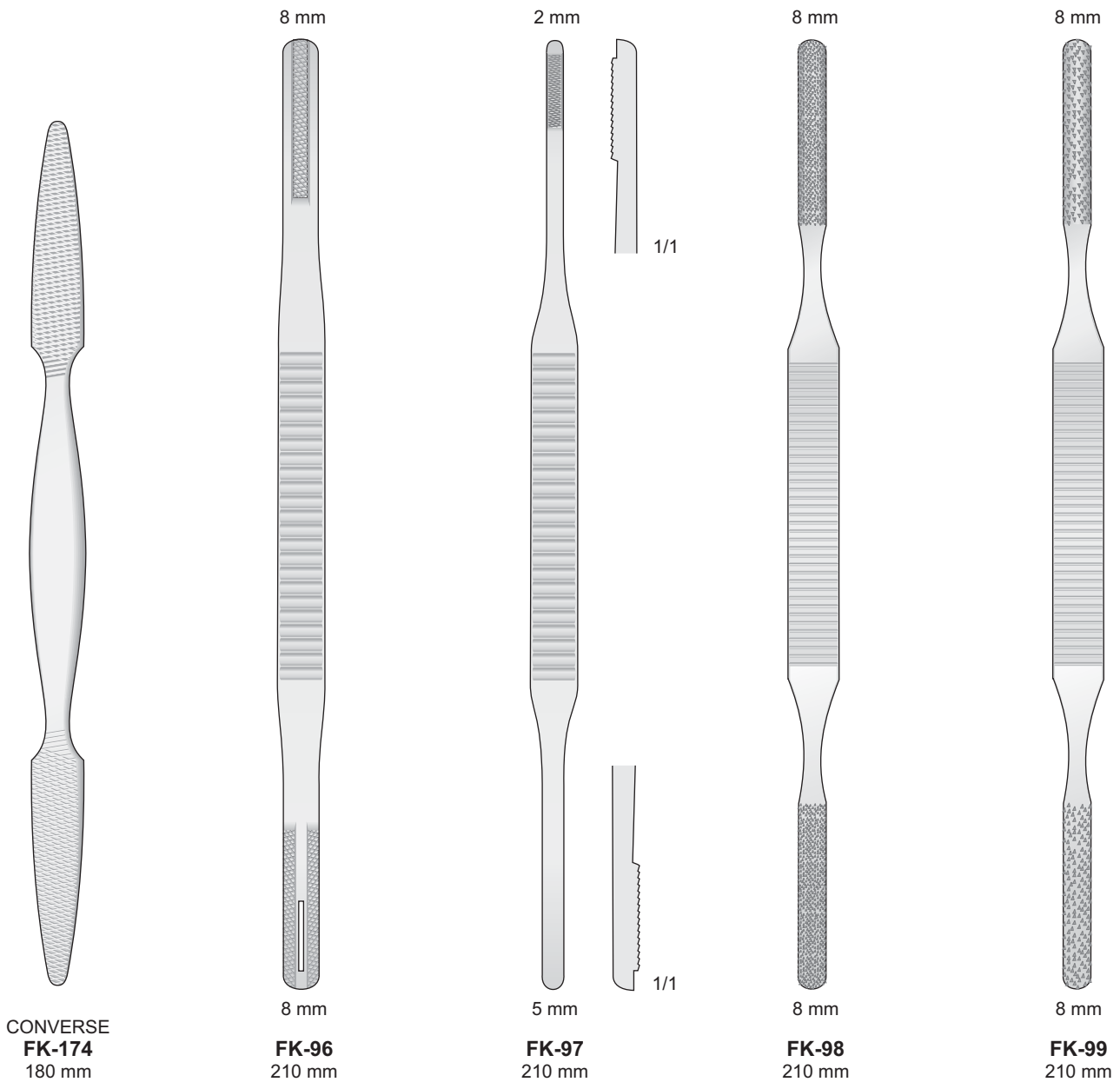

Knochenfeilen

Bone files

Lime per osso

Limas para huesos

Limes à os

Nasenfeilen
Nasal File
Lima nasale
Lima nasales
Lime nasales

Nasenraspel
Nasal Rasp
Raspa nasale
Raspador nasal
Râpe nasale

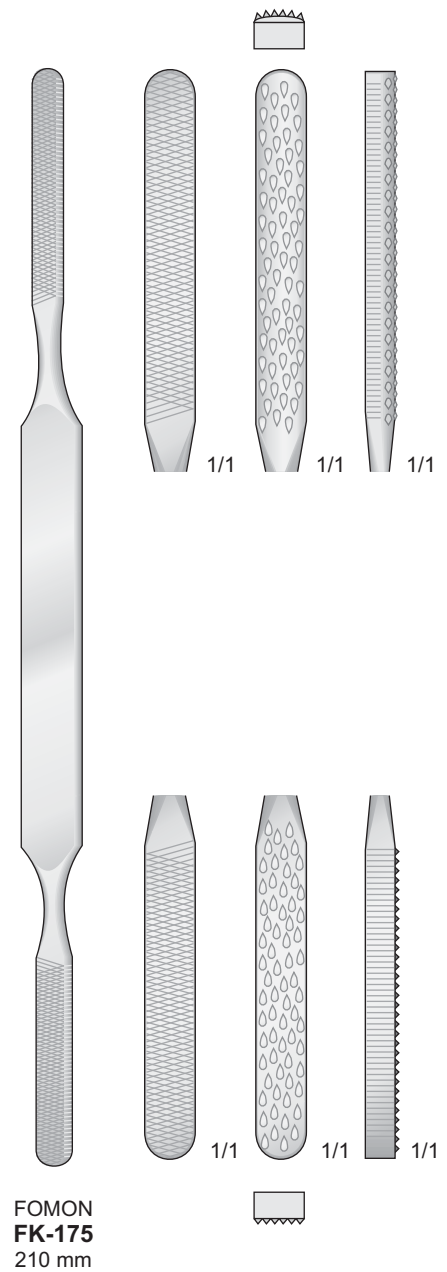
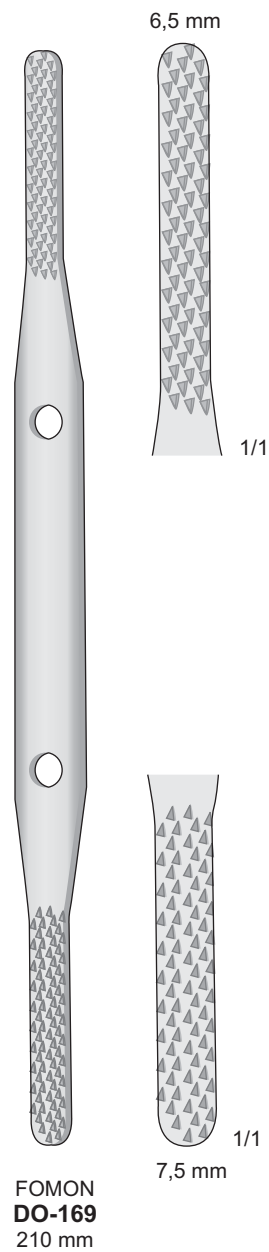
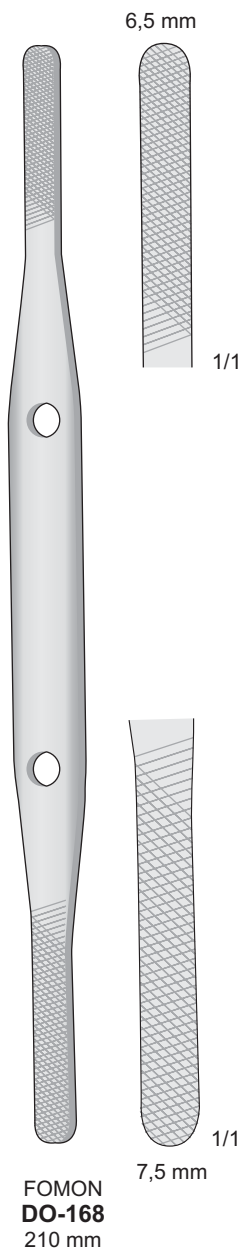

Knochenfeilen

Bone files

Lime per osso

Limas para huesos

Limes à os

Knorpelschaber
Cartilage abraders
Raschiatore per cartilagine
Rascador de cartilago
Grattoir à cartilages



**DINGMANN
DO-245**
160 mm
1-L

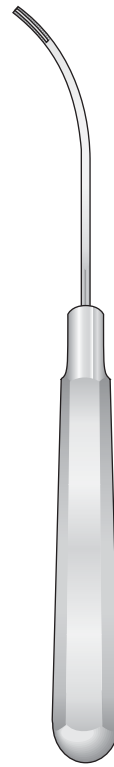

**DINGMANN
DO-246**
160 mm
2-R



**JOSEPH
FK-193**
160 mm

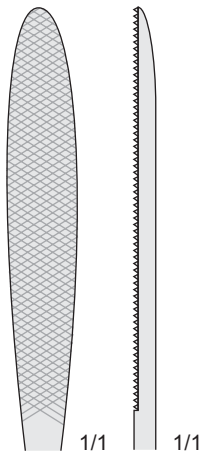

FK-193
160 mm

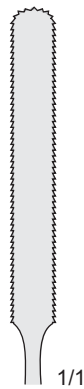

1/1



1/1

FK-194
160 mm



1/1



1/1

FK-195
160 mm



1/1



1/1

FK-196
160 mm

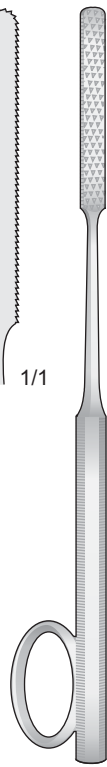

**GALLAHER
FK-194/FK-196**
160 mm

Knochenfeilen

Bone files

Lime per osso

Limas para huesos

Limes à os

Glabellaraspeln - Nasenraspeln
Glabella Rasps - Nasal Rasps
Raspe per glabella - Raspe nasali
Escofinas para glabella - Raspadores nasales
Râpes pour la glabelle - Râpes nasales

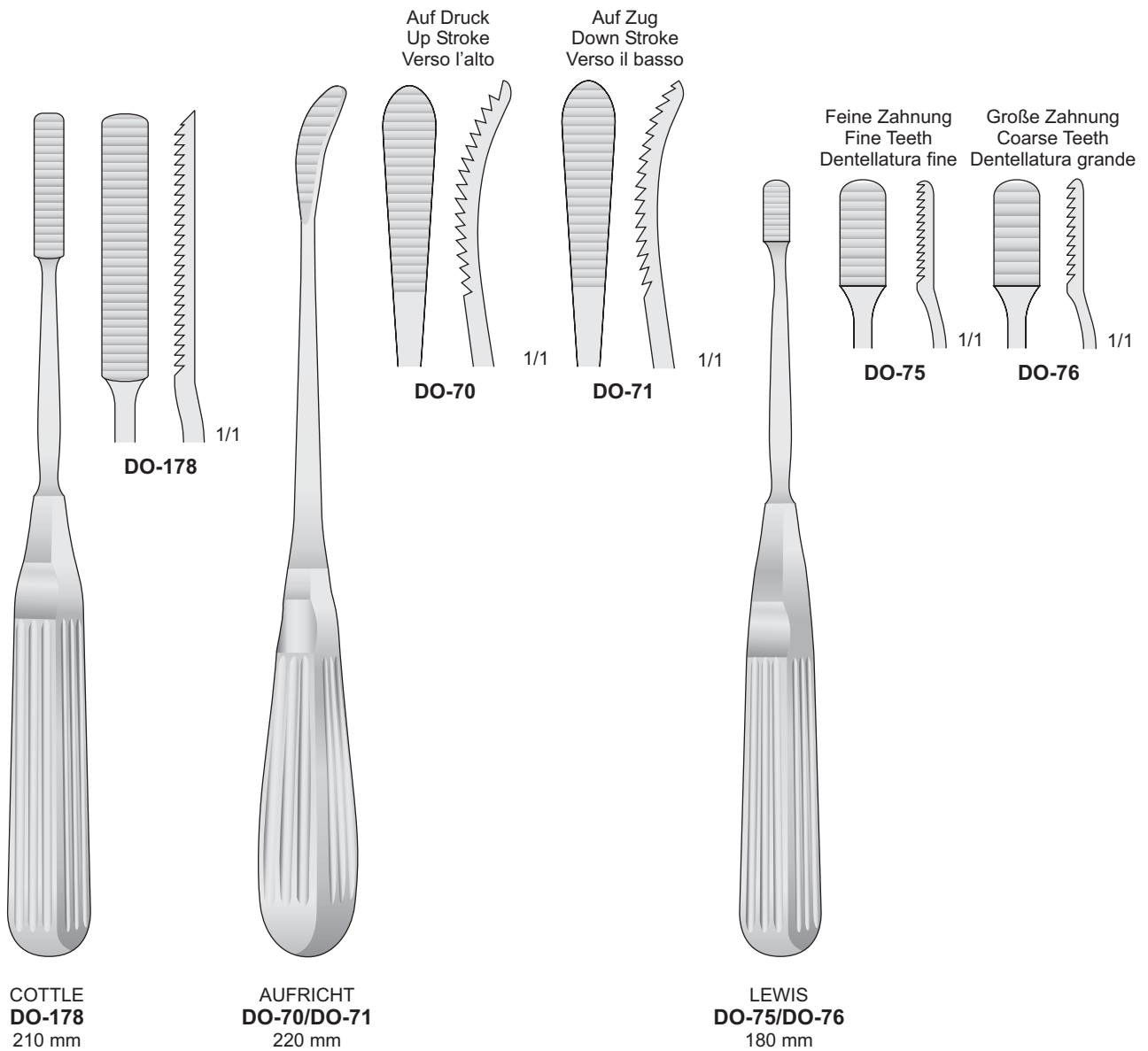

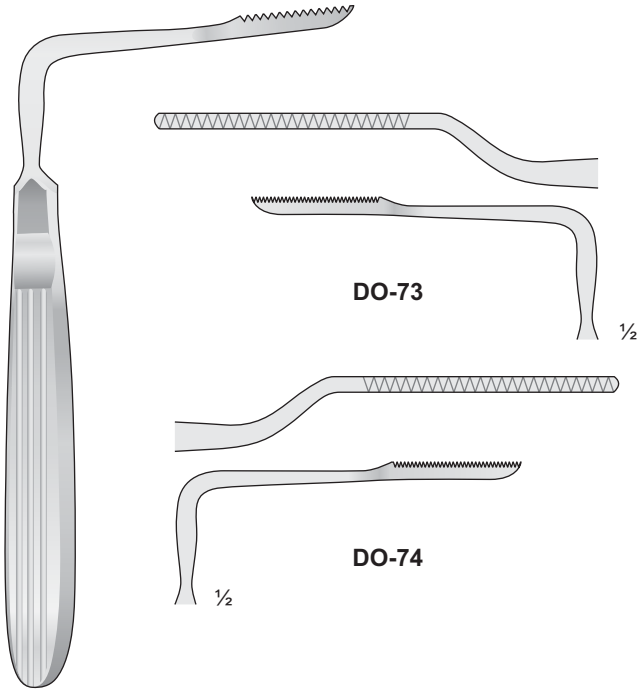

JOSEPH
DO-73/DO-74
135 mm

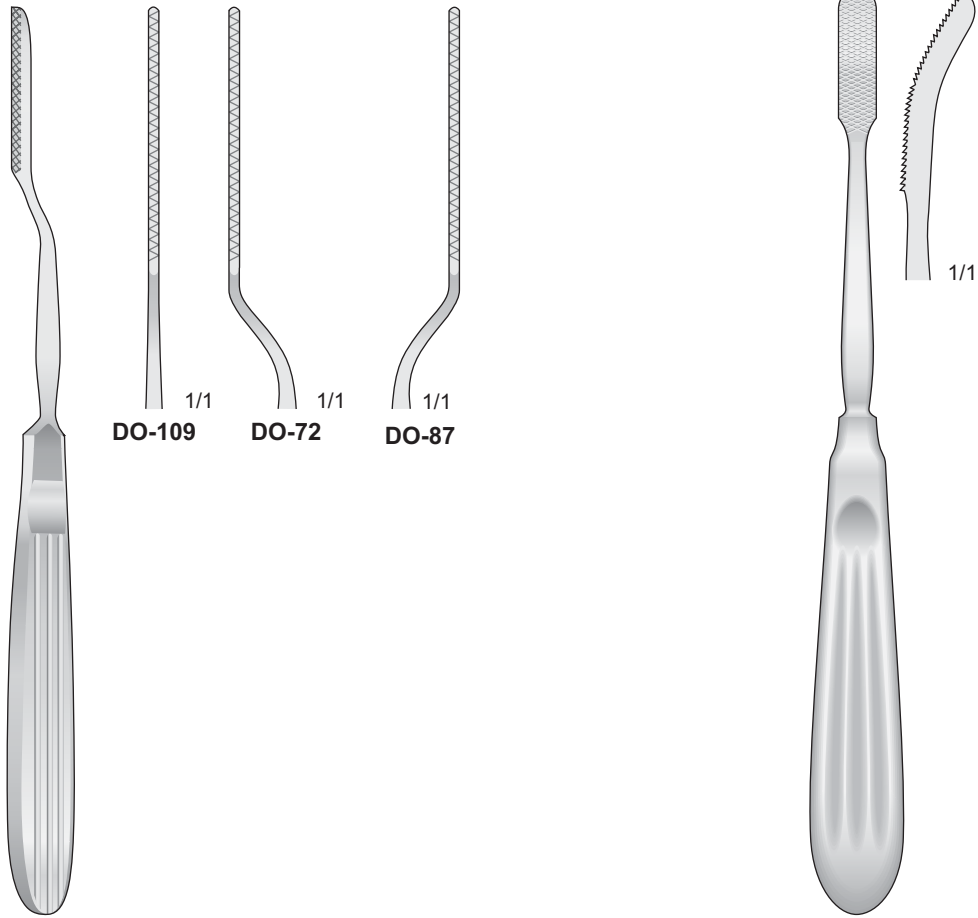

JOSEPH
DO-72/DO-109
190 mm

DO-189
195 mm

Knochenfeilen

Bone files

Lime per osso

Limas para huesos

Limes à os

Nasenraspeln - Nasal Rasps
Raspe nasali - Escofinas nasales
Râpes nasales

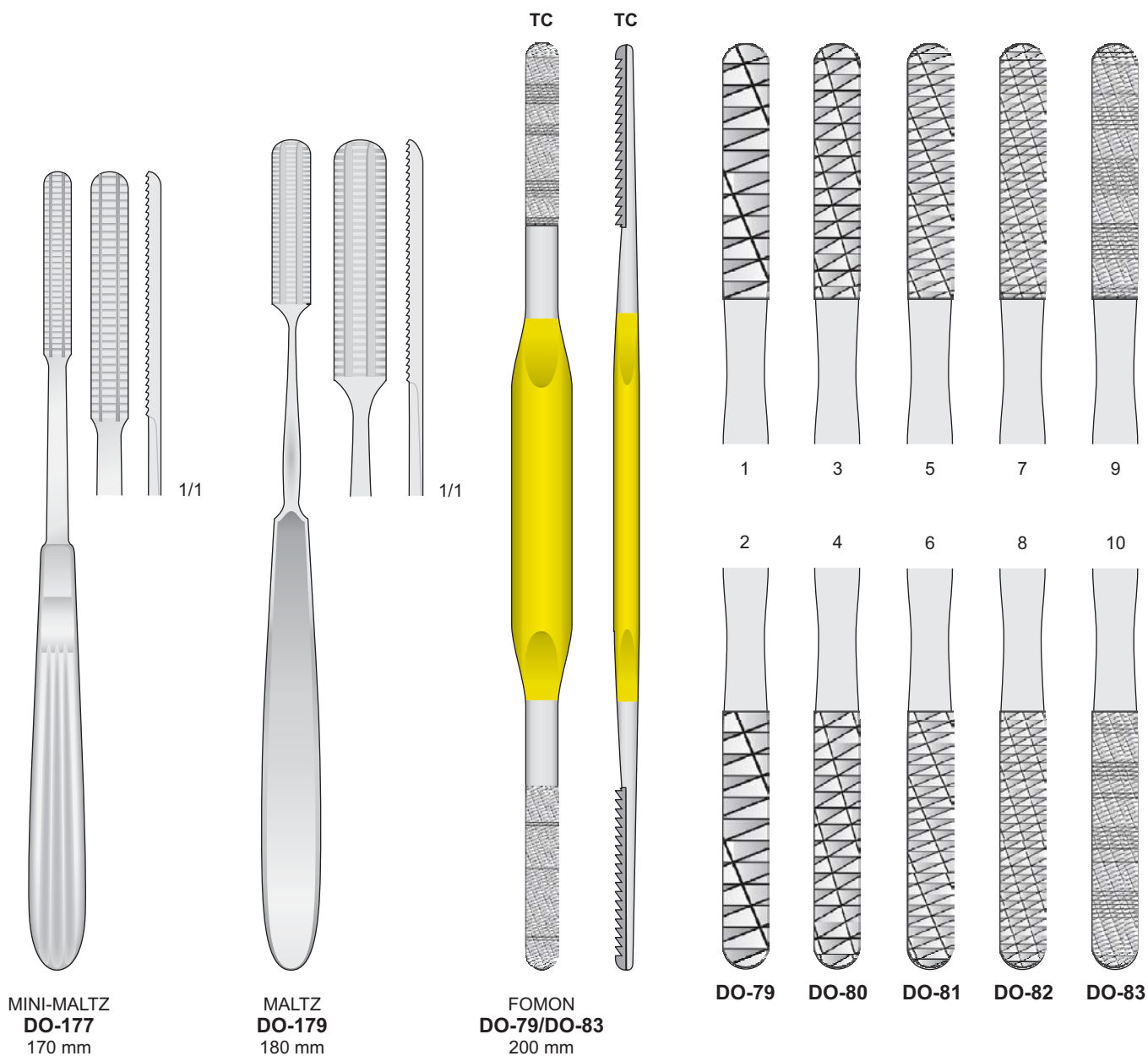

Glabellaraspeln - Nasenraspeln
 Glabella Rasps - Nasal Rasps
 Raspe per glabella - Raspe nasali
 Escofinas para glabella - Raspadores nasales
 Râpes pour la glabelle - Râpes nasales

Mit hartmetalleinsätzen - Tungsten-carbide inserts
 Con inserti al carburo di tungsteno - Escofinas con tungsteno
 Avec plaquettes en carbure de tungstène



DO-312
210 mm

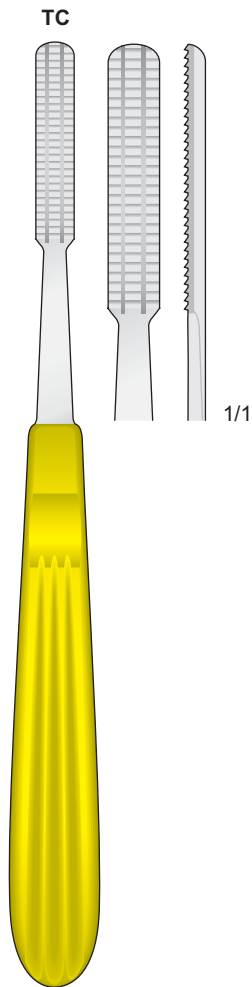

MALTZ DO-315
170 mm



MALTZ DO-301/DO-305
195 mm

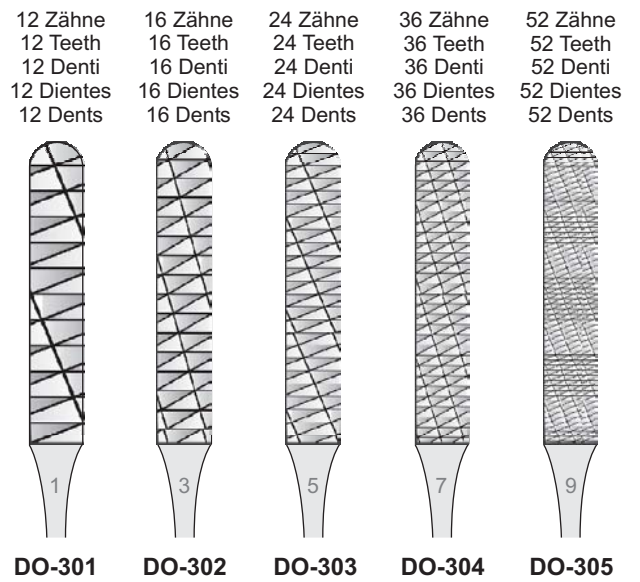

Scharfe Löffel

Sharp curettes

Curette, Cucchiari
taglianti

Cucharillas cortantes

Curettes tranchantes

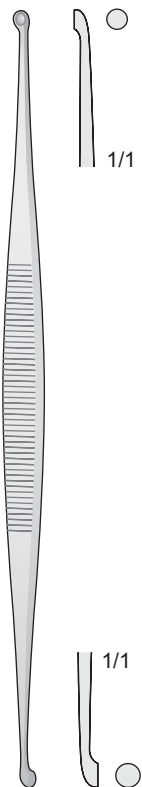

MARTINI
FK-70
140 mm

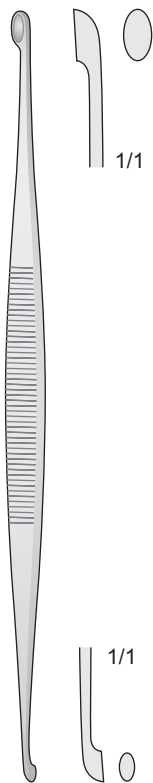

WILLIGER
FK-71
145 mm

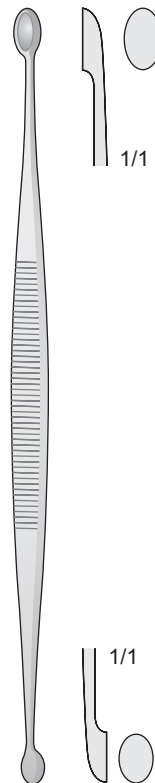

JACOBSON
FK-75
140 mm

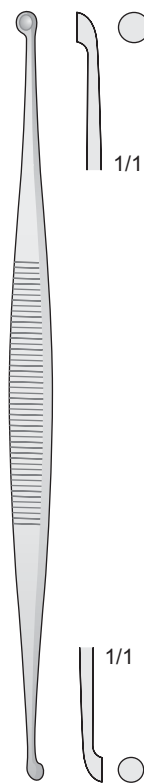

MARTINI
FK-76
140 mm

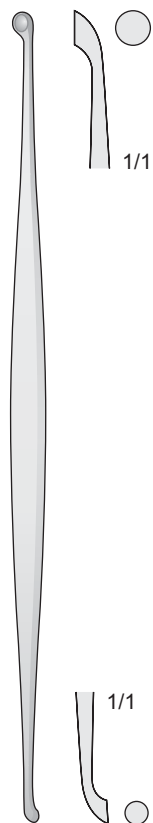

JANSEN
FK-77
160 mm

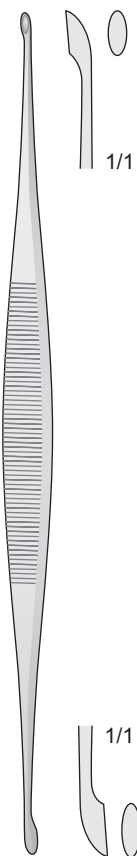

BARTH
FK-78
180 mm

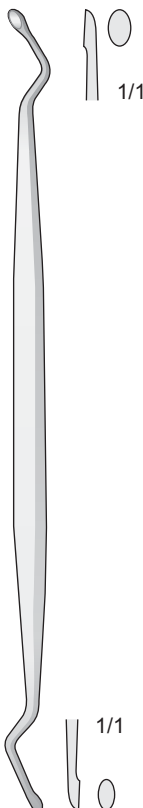

FK-83
160 mm

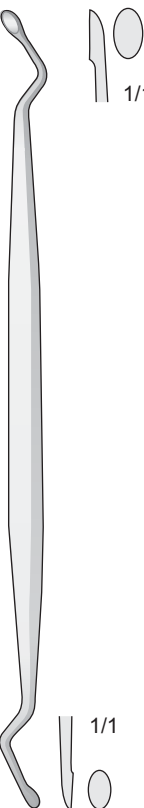

JANSEN
FK-84
160 mm

Scharfe Löffel

Sharp currettes

Curette, Cucchiari taglianti

Cucharillas cortantes

Currettes tranchantes

Komedonen Instrumente
Comedone Extractors
Schiacciacomedoni
Extractores para comedones
Tire comédons

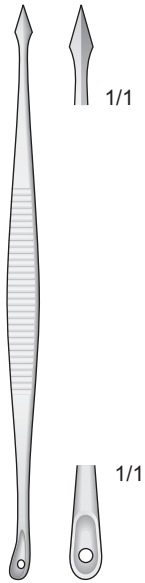

SAALFELD
DS-26
100 mm

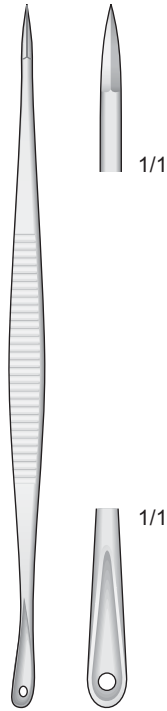

SAALFELD
DS-27
140 mm

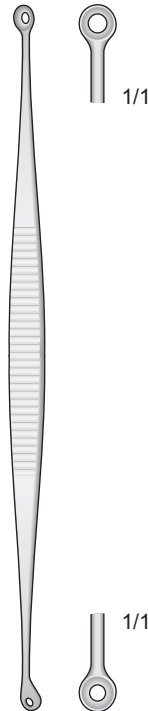

UNNA
DS-28
140 mm

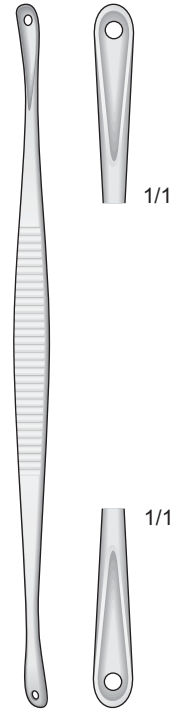

UNNA
DS-29
140 mm

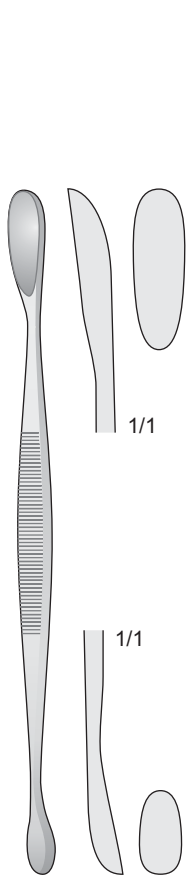

VOLKMANN
FK-79
130 mm

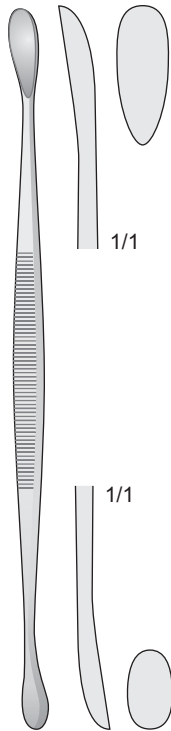

VOLKMANN
FK-72
145 mm

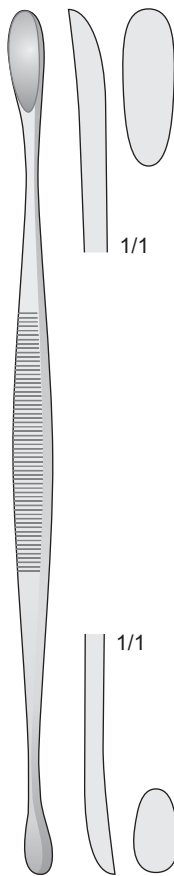

VOLKMANN
FK-73
170 mm

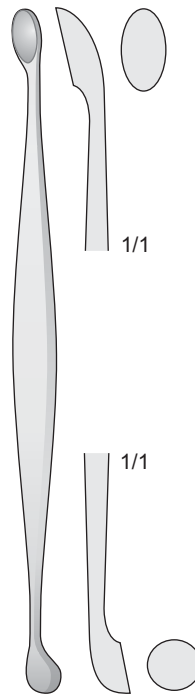

FK-177
130 mm

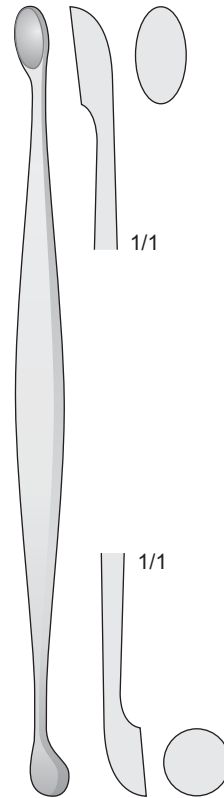

FK-74
160 mm

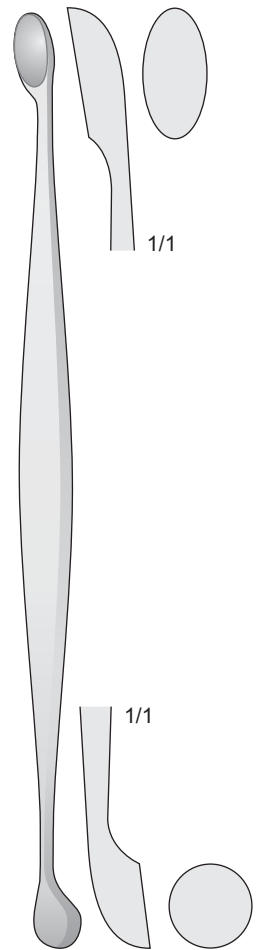

FK-178
200 mm

Scharfe Löffel

Sharp curettes

Curette, Cucchiari
taglianti

Cucharillas cortantes

Curettes tranchantes

Hautstanzen - Dermal punches Offset
Punche da biopsia - Trépanos cutáneos - Trépanos cutanés



FL-150
3 mm

FL-151
4 mm

FL-152
5 mm

FL-153
6 mm

FL-154
8 mm

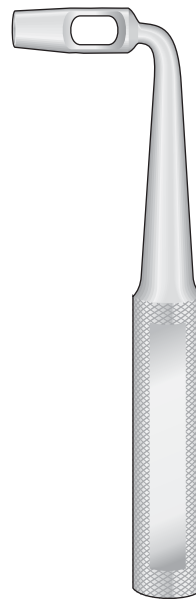

FL-155
3 mm

FL-156
4 mm

FL-157
5 mm

FL-158
6 mm

FL-159
8 mm

KEYES
FL-150/FL-154
100 mm

KEYES
FL-155/FL-159
90 mm

Lupus Küretten - Lupus Curettes
Curette per Lupus - Curetas para Lupus
Curettes pour les Lupus

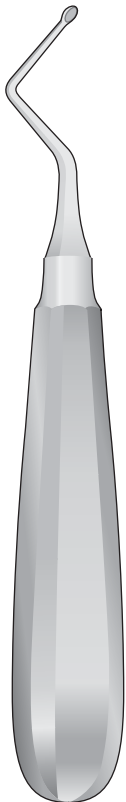

FK-136
FK-137

FK-138
FK-139

KERPEL
FK-136
FK-138
145 mm

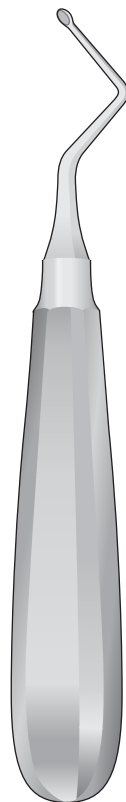

KERPEL
FK-137
FK-139
145 mm

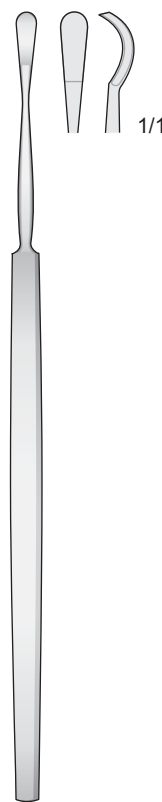

VIDAL
DS-25
140 mm

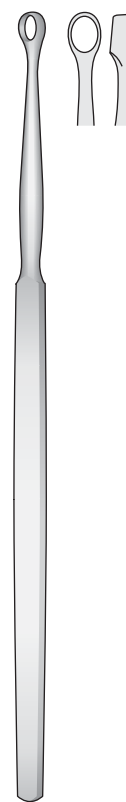

FOX
DS-30/DS-33
140 mm

3 mm 4 mm 5 mm 6 mm
DS-30 DS-31 DS-32 DS-33

Scharfe Löffel

Sharp curettes





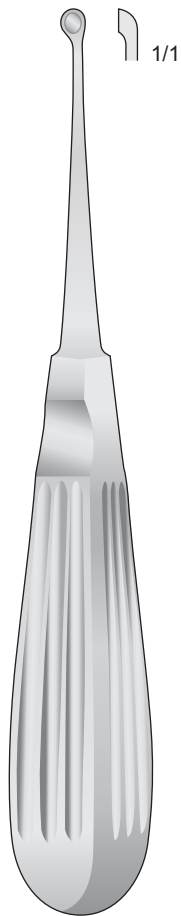

Curette, Cucchiari
taglianti

Cucharillas cortantes

Curettes tranchantes







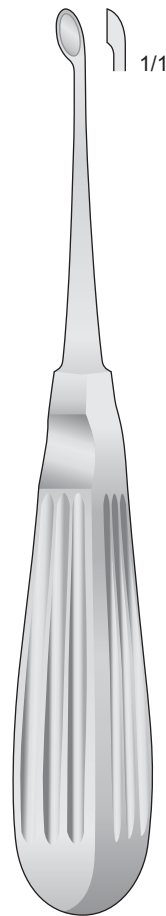

BRUNS
FK-110/FK-116
165 mm

Fig.000 3 mm	Fig.00 4 mm	Fig.0 5 mm
		
FK-110	FK-111	FK-112
Fig.1 6 mm	Fig.2 8 mm	
		
FK-113	FK-114	
Fig.3 10 mm	Fig.4 12 mm	
		
FK-115	FK-116	



SCHEDE
FK-120/FK-126
170 mm

Fig.000 2,5 mm	Fig.00 3,4 mm	Fig.0 4,2 mm
		
FK-120	FK-121	FK-122
Fig.1 5,2 mm	Fig.2 6,3 mm	
		
FK-123	FK-124	
Fig.3 7,4 mm	Fig.4 8 mm	
		
FK-125	FK-126	

Scharfe Löffel

Sharp curettes

Curette, Cucchiari
taglianti

Cucharillas cortantes

Curettes tranchantes

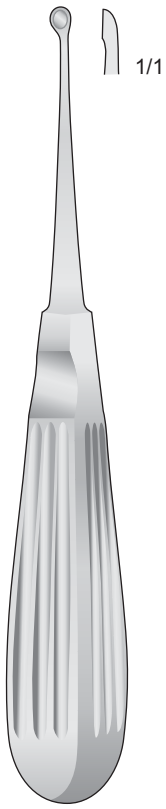

VOLKMANN
FK-60/FK-69
170 mm

Fig.0000
2,8 mm
1/1
FK-60

Fig.000
3,6 mm
1/1
FK-61

Fig.00
4,4 mm
1/1
FK-62

Fig.0
5,2 mm
1/1
FK-63

Fig.1
6,8 mm
1/1
FK-64

Fig.2
8,5 mm
1/1
FK-65

Fig.3
10 mm
1/1
FK-66

Fig.4
11,5 mm
1/1
FK-67

Fig.5
13 mm
1/1
FK-68

Fig.6
14,5 mm
1/1
FK-69

Fig. 00
3,4 mm
1/1
FK-197

Fig. 1
5,2 mm
1/1
FK-198

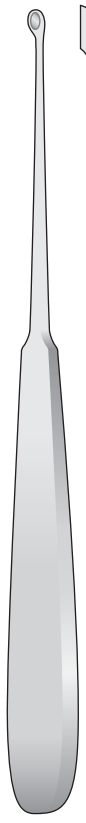

WILLIGER
FK-197/FK-198
170 mm

Marker
Tissue Markers
Marcatore

Semi-Biegsam - Semi-Malleables
Semi-Malleabili - Semi-Maleables
Semi-Malléables

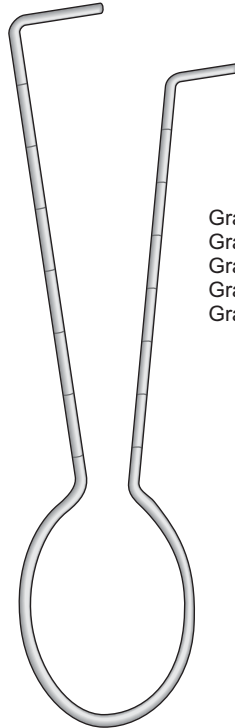

Graduiert cm
Graduated cm
Graduati in cm
Graduadas en cm
Graduée en cm

ES-14 38 mm
ES-15 42 mm
ES-16 45 mm

Areola-Marker
Marca Areola

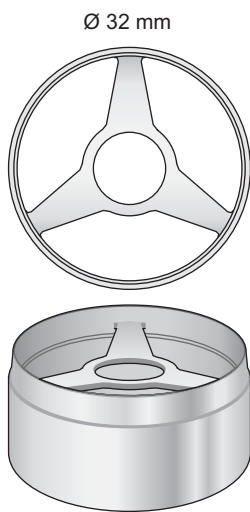

ES-17
32 mm

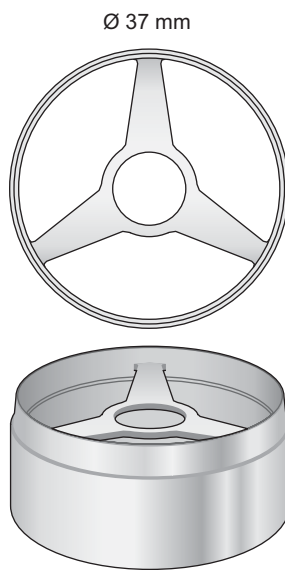

ES-18
37 mm

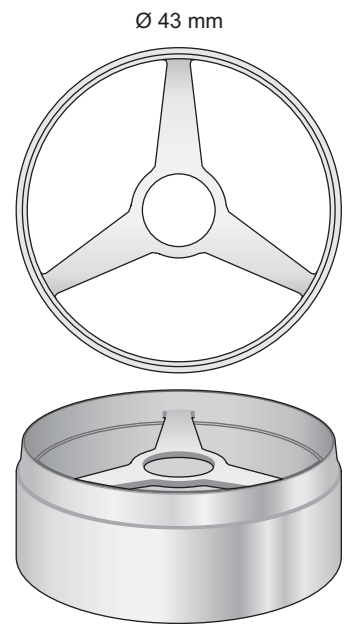

ES-19
43 mm

10

Hohlmeisselzange
Bone rongeurs
Pinze ossivore
Pinzas Gubias
Pinces Gouges

Hohlmeißelzangen

Bone rongeurs

Pinze ossivore

Pinza-gubias

Pinces-gouges

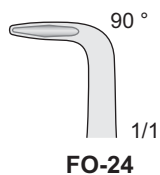
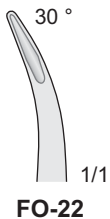
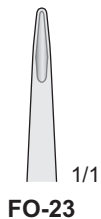
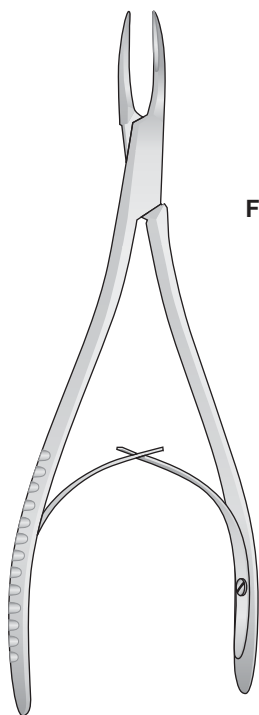

MINI-FRIEDMANN
FO-22/FO-24
150 mm

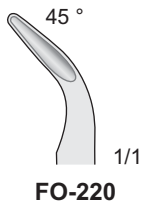
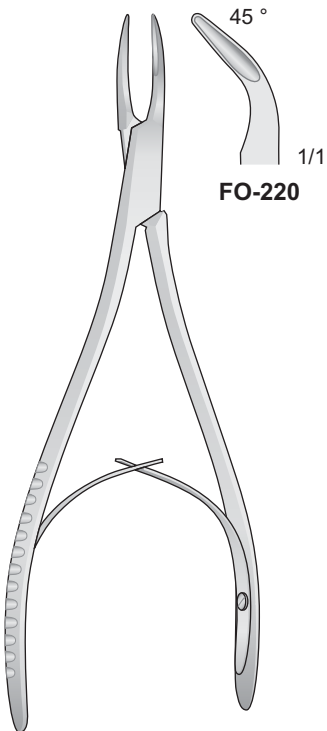

MINI-FRIEDMANN
FO-220
150 mm

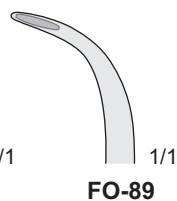
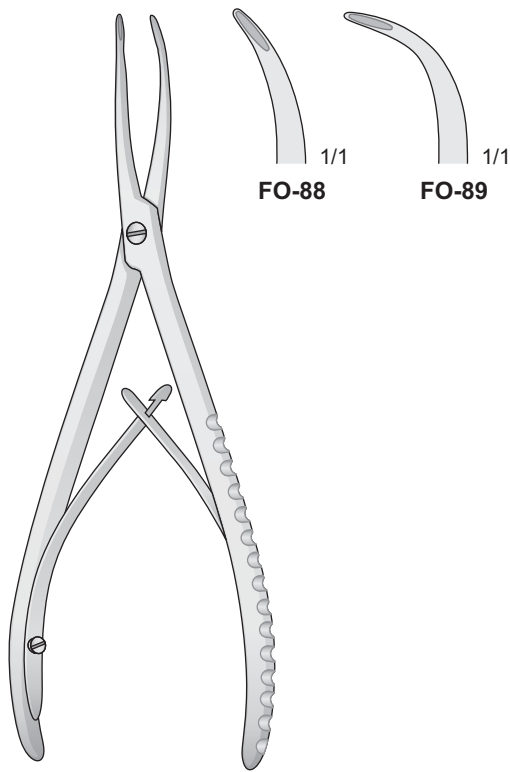

STELLBRINK
FO-88/FO-89
170 mm

Hohlmeißelzangen

Bone rongeurs

Pinze ossivore

Pinza-gubias

Pinces-gouges

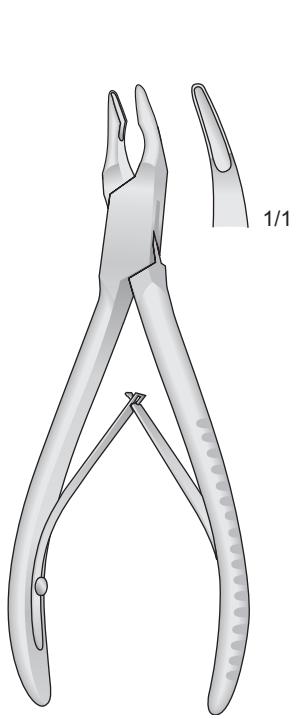

MINI-FRIEDMANN
FO-15
120 mm

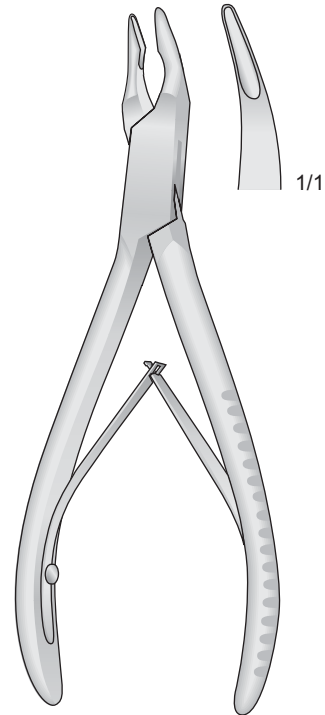

FRIEDMANN
FO-17
140 mm

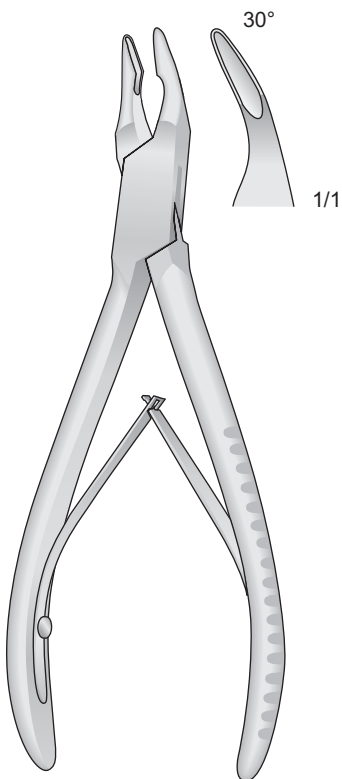

BLUMENTHAL
FO-19
150 mm

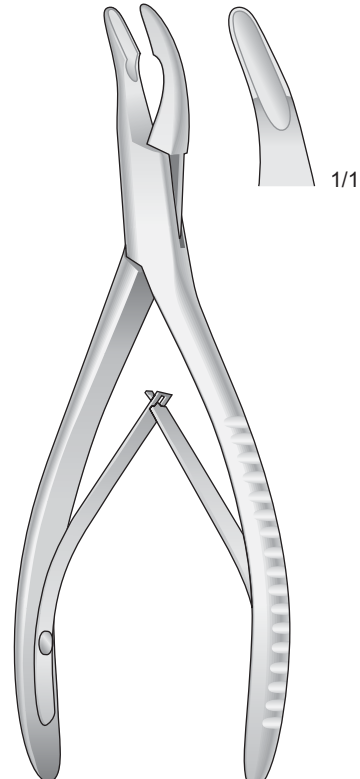

MEAD
FO-21
165 mm

Hohlmeißelzangen

Bone rongeurs

Pinze ossivore

Pinza-gubias

Pinces-gouges

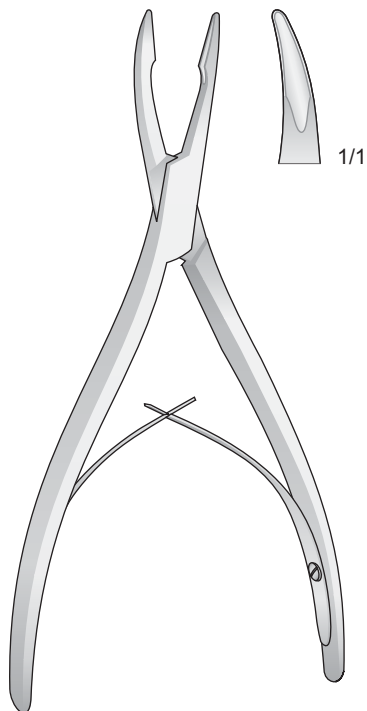

FRIEDMANN
FO-16
160 mm

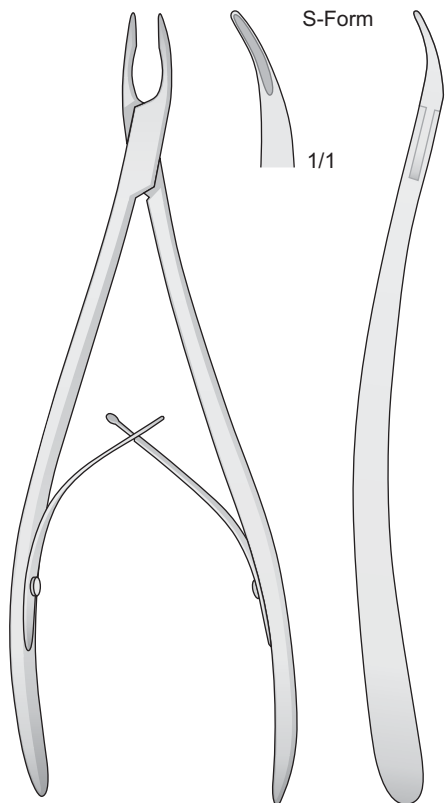

STELLBRINK
FO-87
190 mm

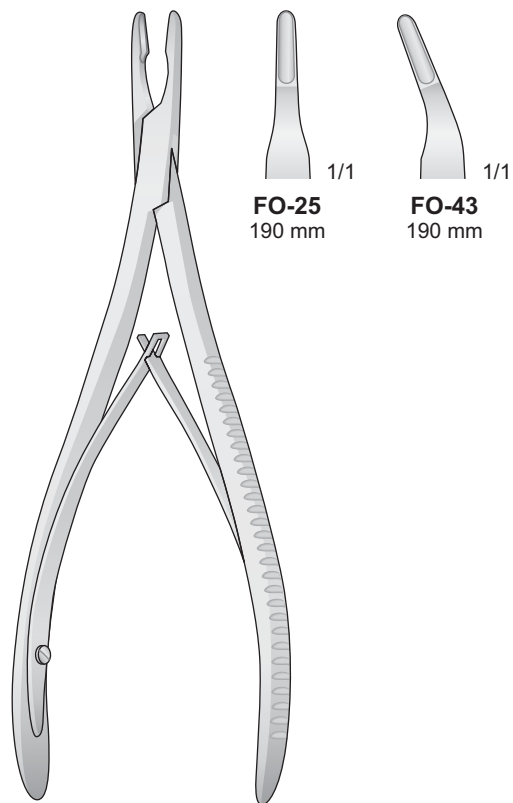

LEMPERT
FO-25/FO-43
190 mm

Hohlmeißelzangen

Bone rongeurs

Pinze ossivore

Pinza-gubias

Pinces-gouges

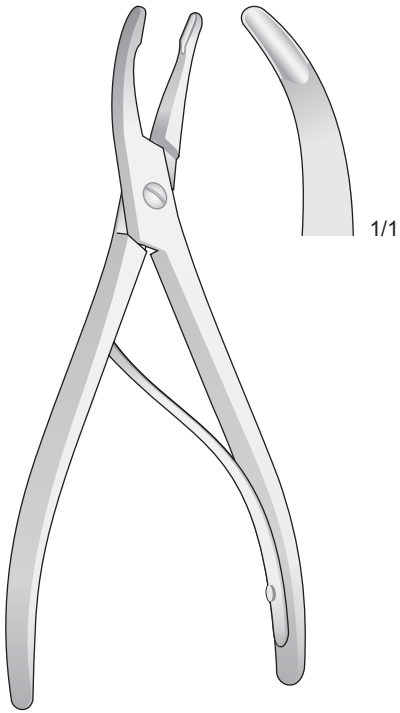

LUER
FO-18
155 mm

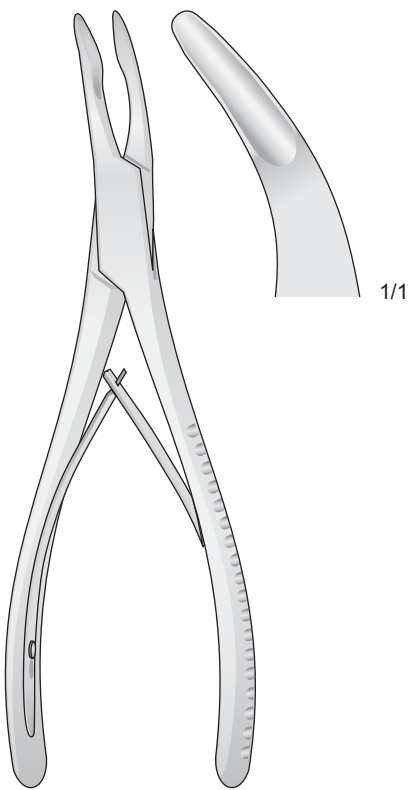

OLIVECRONA
FO-45
190 mm

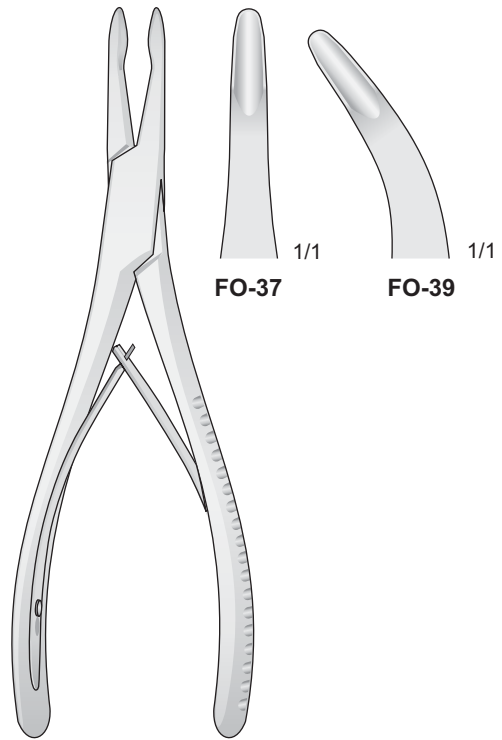

JANSEN
FO-37/FO-39
170 mm

Hohlmeißelzangen

Bone rongeurs

Pinze ossivore

Pinza-gubias

Pinces-gouges

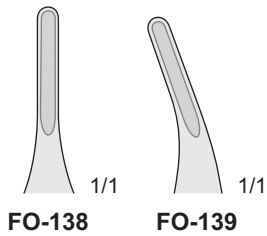
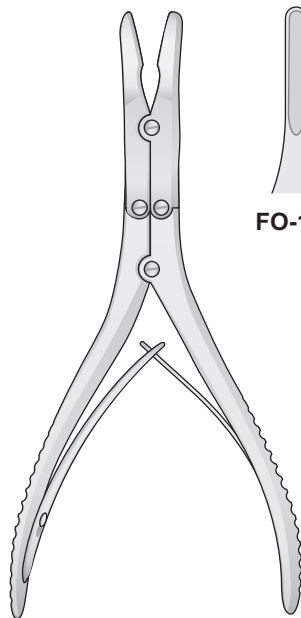

RUSKIN
FO-138/FO-139
150 mm

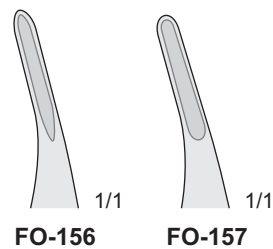
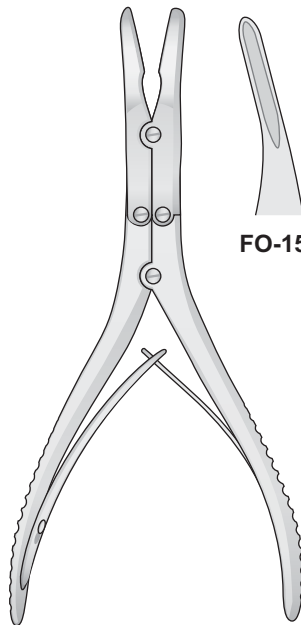

KLEINERT-KUTZ
FO-156/FO-157
155 mm

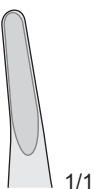
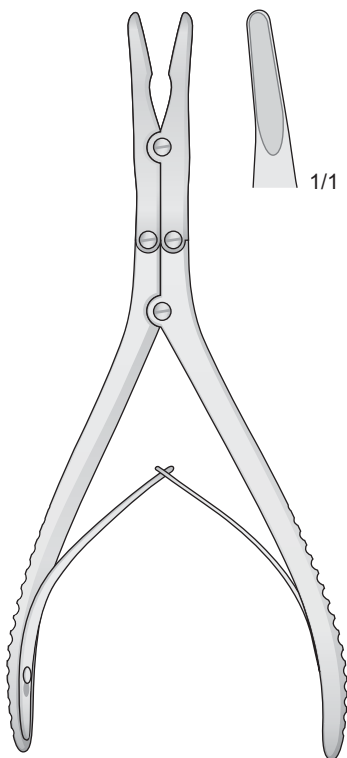

BEYER
FO-20
180 mm

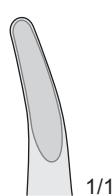
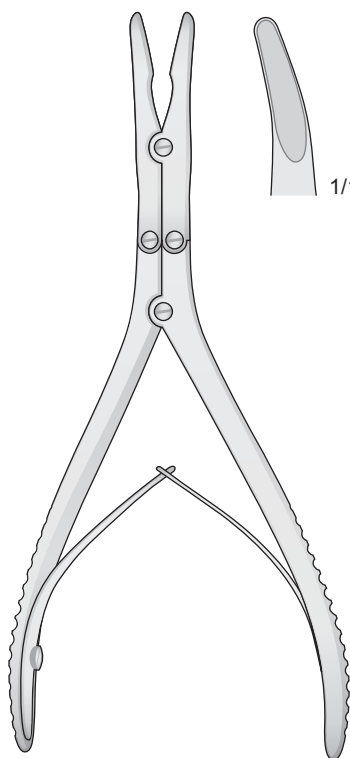

ZAUFAL-JANSEN
FO-34
180 mm

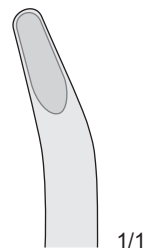
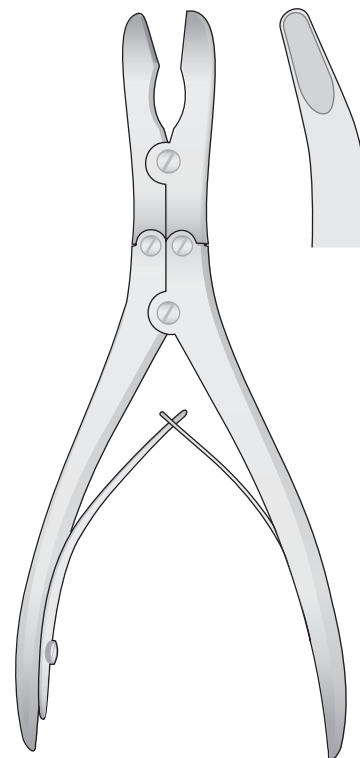

RUSKIN-STILLE
FO-35
180 mm

Hohlmeißelzangen

Bone rongeurs

Pinze ossivore

Pinza-gubias

Pinces-gouges

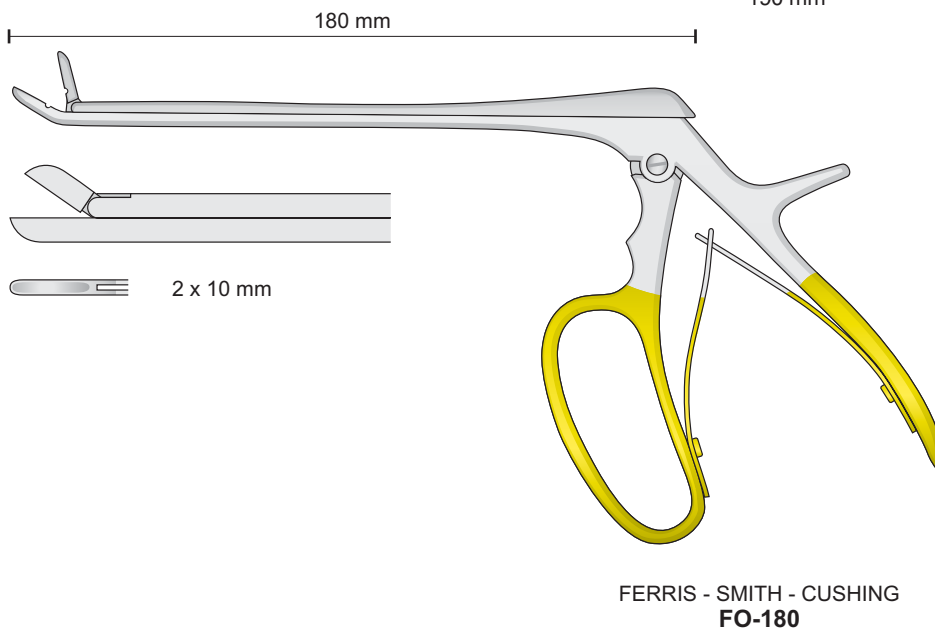
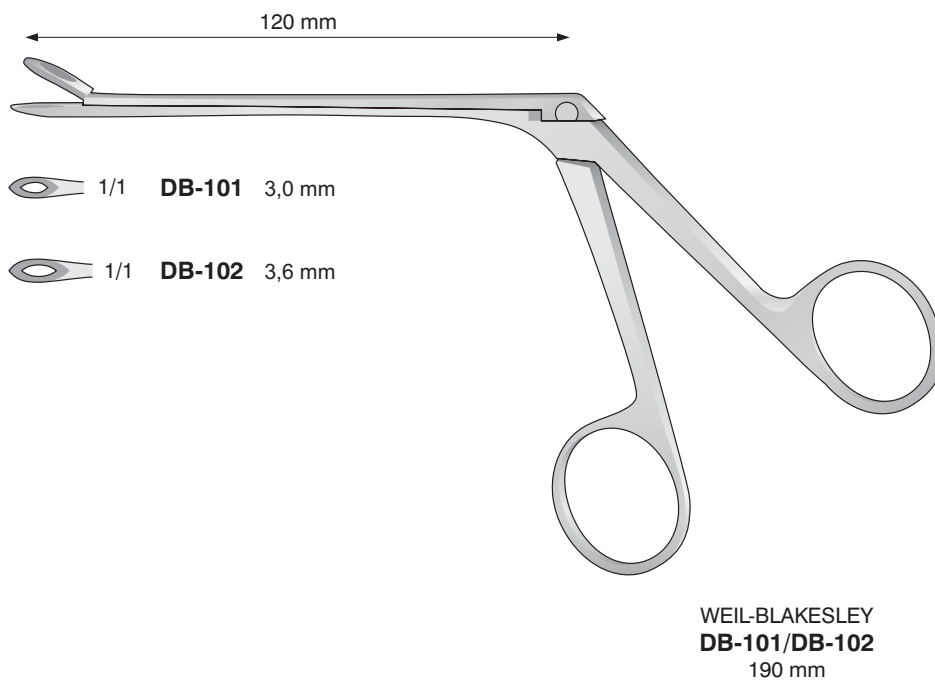
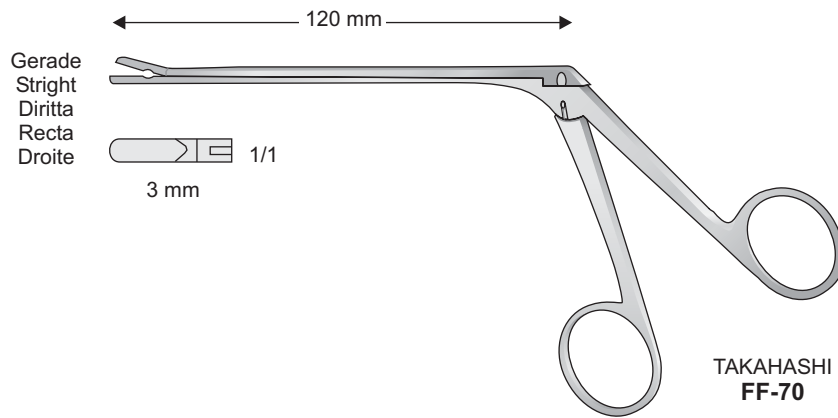

Pinze ossivore

Bone Cutting Forceps

Knochensplitterzangen

Pincès coupantes à os

Pinza cortante para huesos

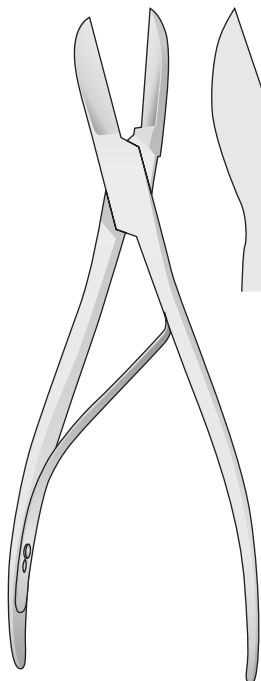

**LISTON
LX-109**
170 mm

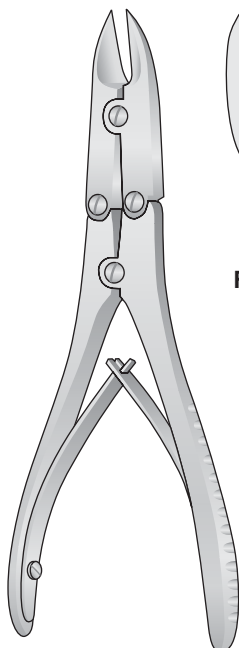

**BÖHLER
FO-60/FO-61**
150 mm

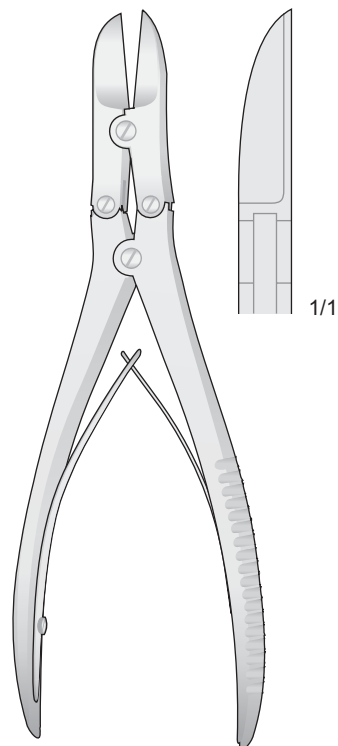
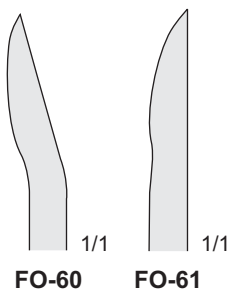

**RUSKIN-LISTON
FO-108**
190 mm

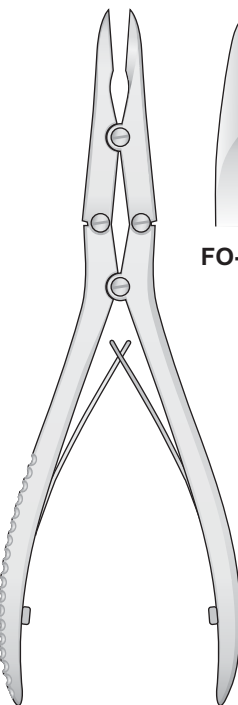

FO-58/FO-59
180 mm

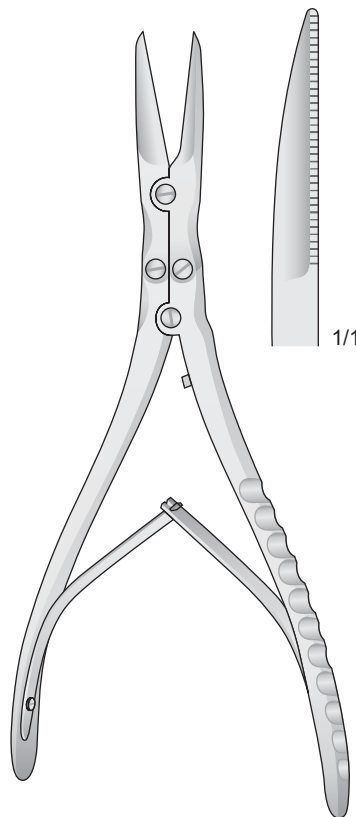
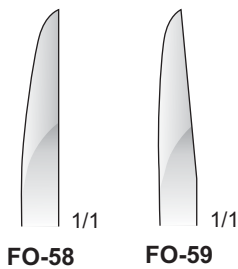

FO-146
215 mm

Zange mit Zahnsperre
Forceps with ratchet fixation
Pinza con cremagliera
Davier à crémaillère

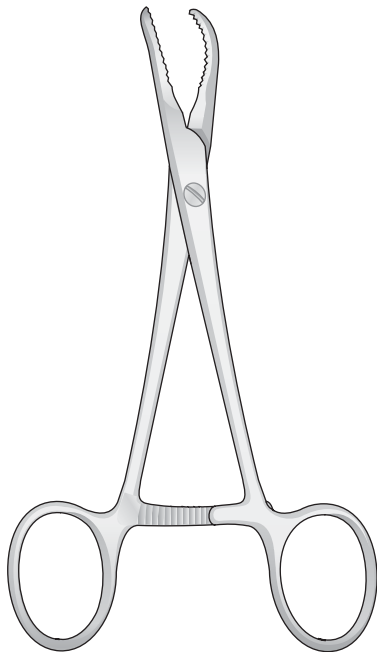

FO-47
140 mm

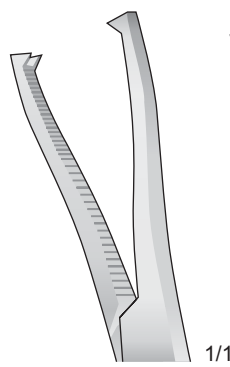

DINGMANN
FO-130

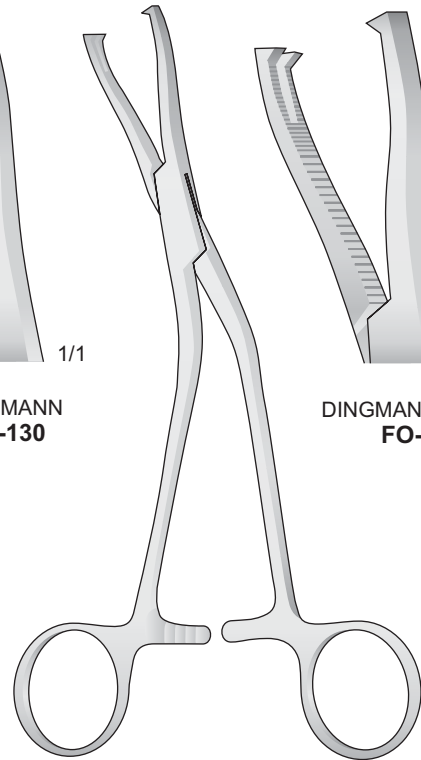

DINGMANN
FO-130/FO-131
190 mm

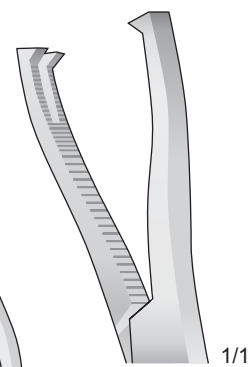

DINGMANN MODIF.
FO-131

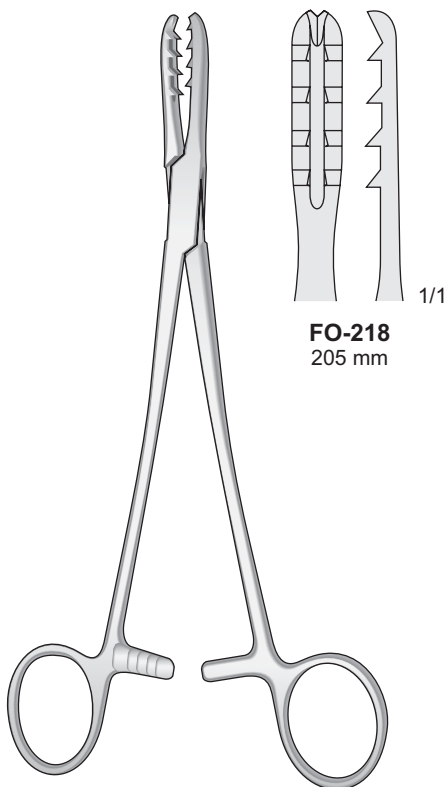

BIRCHER-GANSKE
FO-218
205 mm

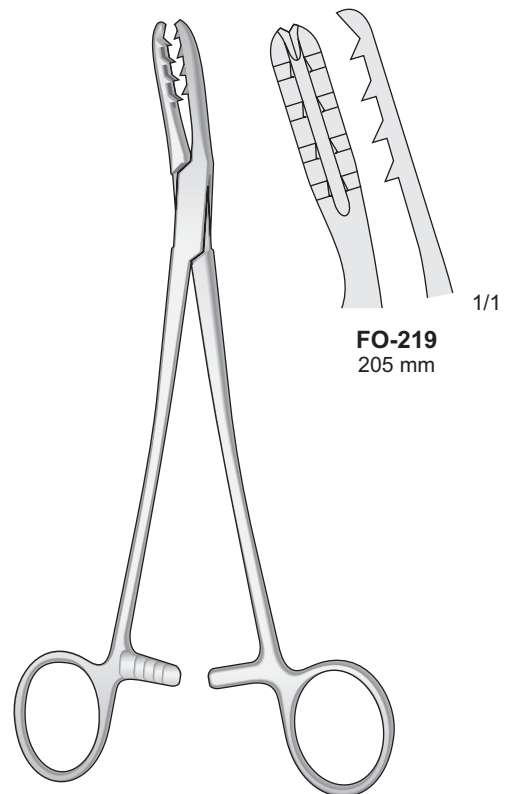

BIRCHER-GANSKE
FO-219
205 mm

Drahtschneidezangen

Wire cutting pliers

Tronchesi per fili
metallici

Cortador de agujas
kirschner

Pinces à couper le fil

Für weichen Draht Ø 2 mm
Für harten Draht Ø 1,5 mm
For soft wire Ø 2 mm
For hard wire Ø 1,5 mm
Per filo leggero Ø 2 mm
Per filo duro Ø 1,5 mm
Para alambres ligero Ø 2 mm
Para alambres duro 1,5 mm
Pour fil léger Ø 2 mm
Pour fil dur Ø 1,5 mm

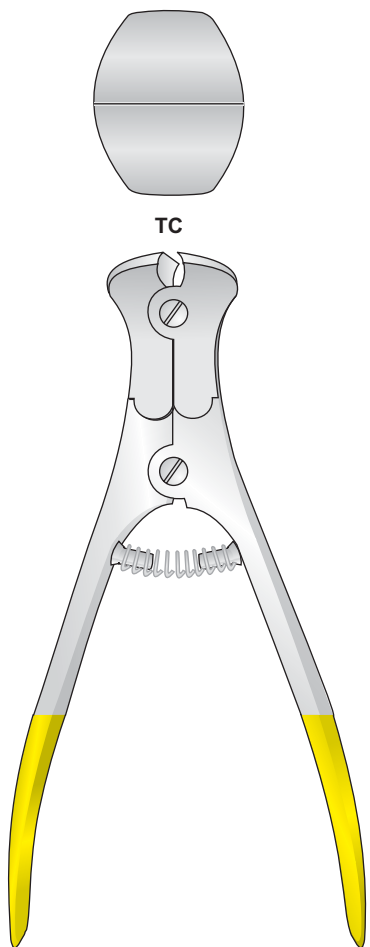

LX-102
145 mm

Für weichen Draht Ø 2 mm
Für harten Draht Ø 1,6 mm
For soft wire Ø 2 mm
For hard wire Ø 1,6 mm
Per filo leggero Ø 2 mm
Per filo duro Ø 1,6 mm
Para alambres ligero Ø 2 mm
Para alambres duro Ø 1,6 mm
Pour fil léger Ø 2 mm
Pour fil dur Ø 1,6 mm

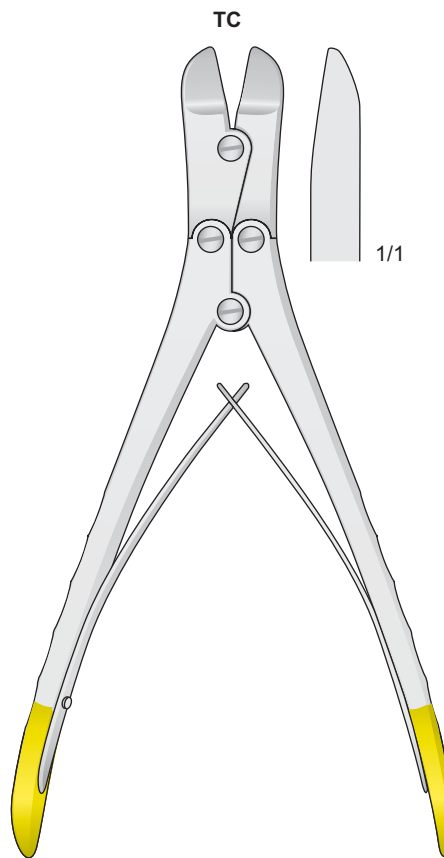

LX-103
170 mm

Extraktionszangen
für Bohrdrähte

Extraction pliers
for boring wires

Pinze per estrazione
fili metallici

Pinzas para extracción
de hilo metálico

Pinces pour
l'extraction des broches

Draht-und Bleischere gezahnt - Wire cutting scissor serrated
Forbice universale dentellata - Tijeras para cortar hilo de acero dentadas
Ciseaux à couper les fils métalliques

TC

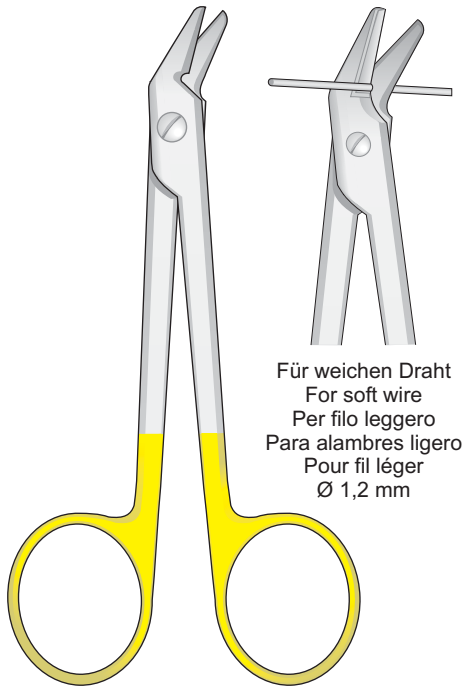

Für weichen Draht
For soft wire
Per filo leggero
Para alambres ligero
Pour fil léger
Ø 1,2 mm

DP-120
120 mm

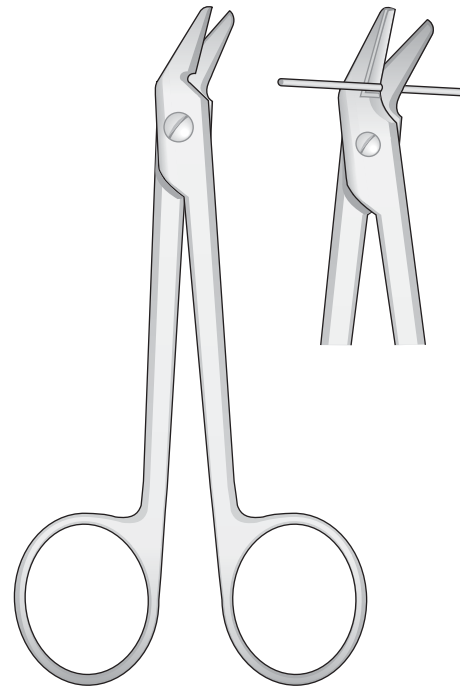

DP-90
120 mm

TC

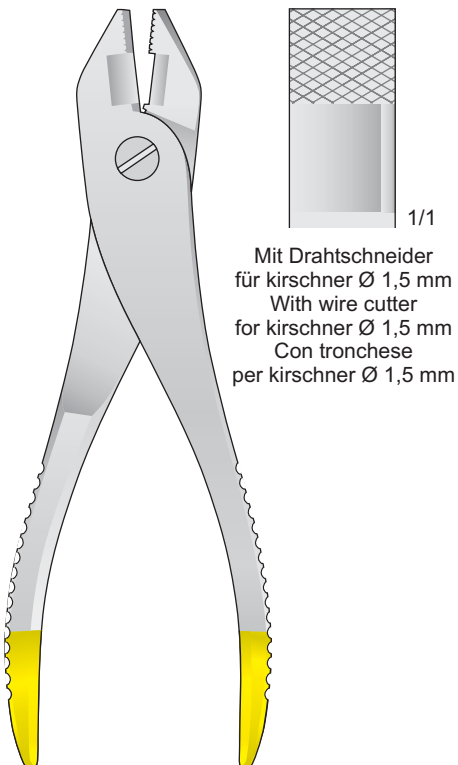

Mit Drahtschneider
für kirschner Ø 1,5 mm
With wire cutter
for kirschner Ø 1,5 mm
Con tronchese
per kirschner Ø 1,5 mm

LX-125
220 mm

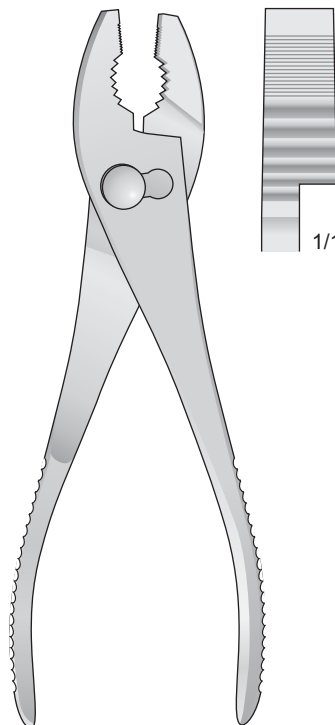

VH-40
200 mm

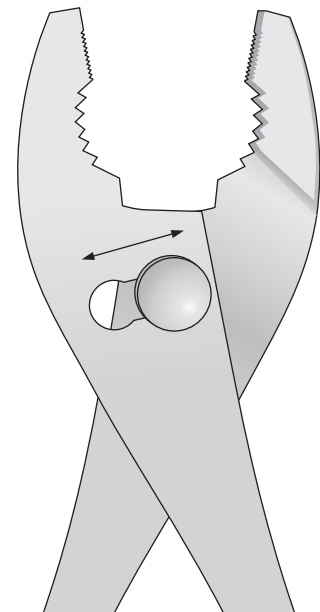

Extraktionszangen
für Bohrdrähte

Extraction pliers
for boring wires

Pinze per estrazione
fili metallici

Pinzas para extracción
de hilo metálico

Pinces pour
l'extraction des broches

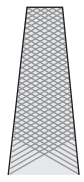

1/1

VH-20

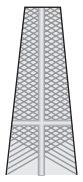
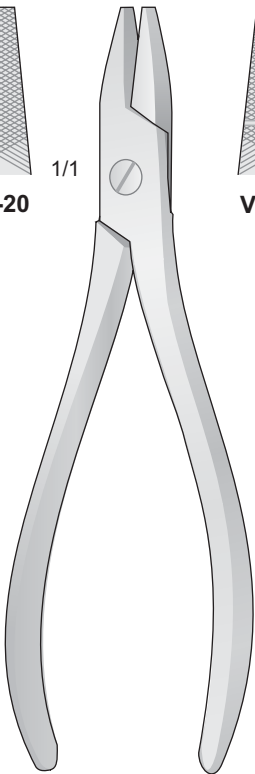

1/1

VH-21

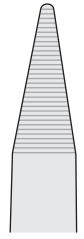
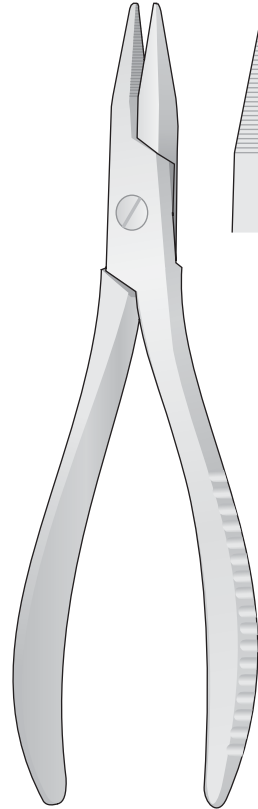

1/1

VH-20/VH-21
175 mm

VH-23
190 mm

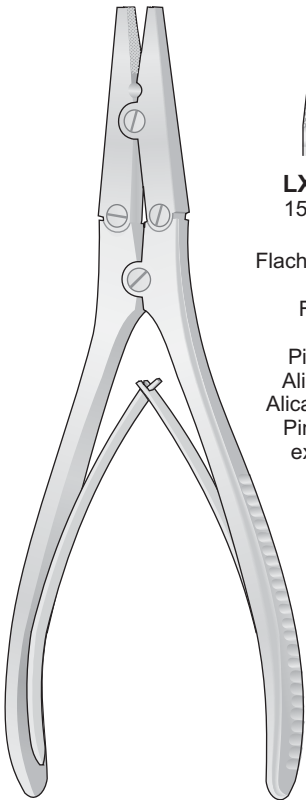

2,5 mm

3,5 mm

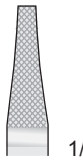

1/1

LX-138
150 mm

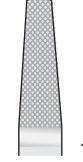

1/1

LX-139
180 mm

Flachzange, Extraktionszange
für Bohrdrähte
Flat pliers, Extraction
pliers for wires
Pinze per estrazione fili
Alicates para extracción,
Alicates para sacar alambre
Pince plate, Pinces pour
extraction des broches

LX-138/LX-139

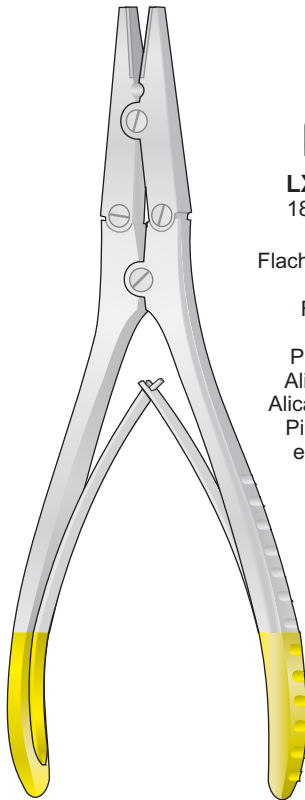

3 mm

6 mm

TC

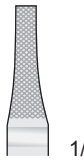

1/1

LX-140
180 mm

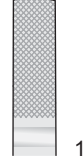

1/1

LX-141
180 mm

Flachzange, Extraktionszange
für Bohrdrähte
Flat pliers, Extraction
pliers for wires
Pinze per estrazione fili
Alicates para extracción,
Alicates para sacar alambre
Pince plate, Pinces pour
extraction des broches

LX-140/LX-141

Für Kinder
For children
Per bambini
Para niños
Pour enfants

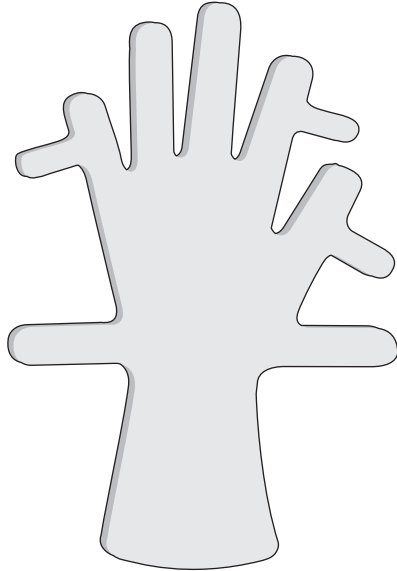

FO-299

Für Erwachsene - For adults - Per adulti
Para adultos - Pour adultes

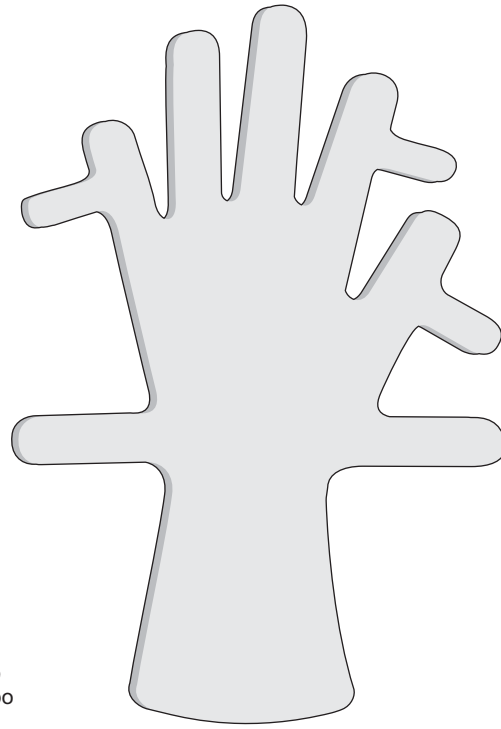

FO-300

Bleihände
Lead hands
Mani di piombo
Manos de plombo
Main de plomb

Nagel -Ausreisszange
Nail extracting forceps
Pinza per estrazione delle unghie
Pinzas para arrancar uñas
Pince pour extraire les ongles

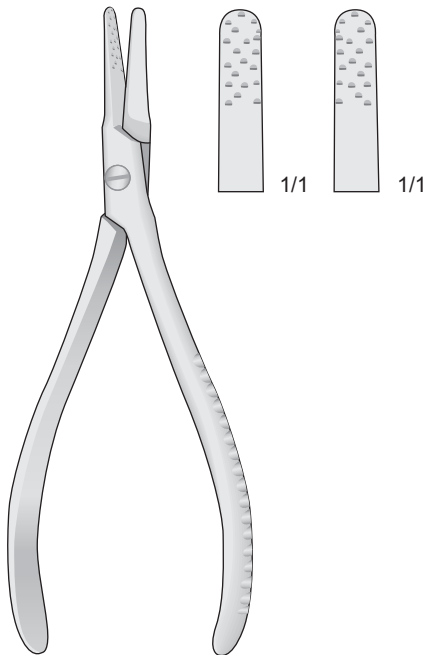

**RADOLF
FO-159
135 mm**

Nagelspaltzange
Nail nipper
Pinza per unghie
Pinzas corta uñas
Pince à ongles

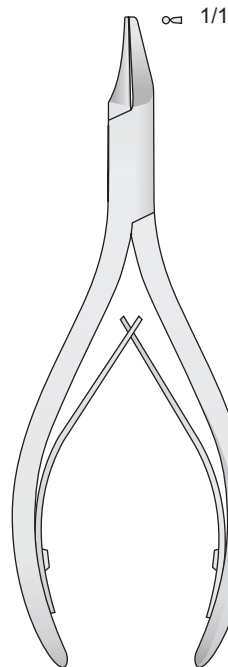

**DP-09
135 mm**

Repositionszangen

Reposition forceps

Pinze per riposizione

Pinzas para reduccion

Pinces de reposition

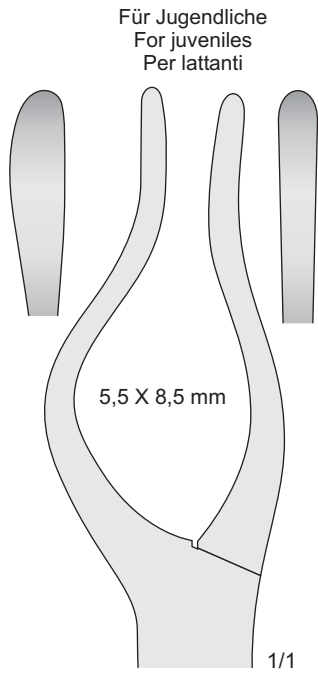

DO-10 L
DO-11 R
225 mm

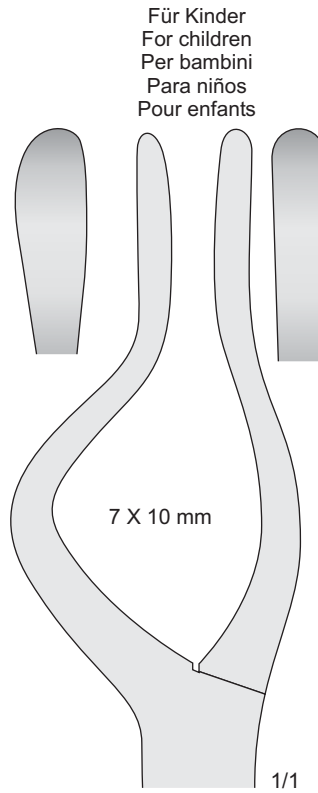

DO-12 L
DO-13 R
235 mm

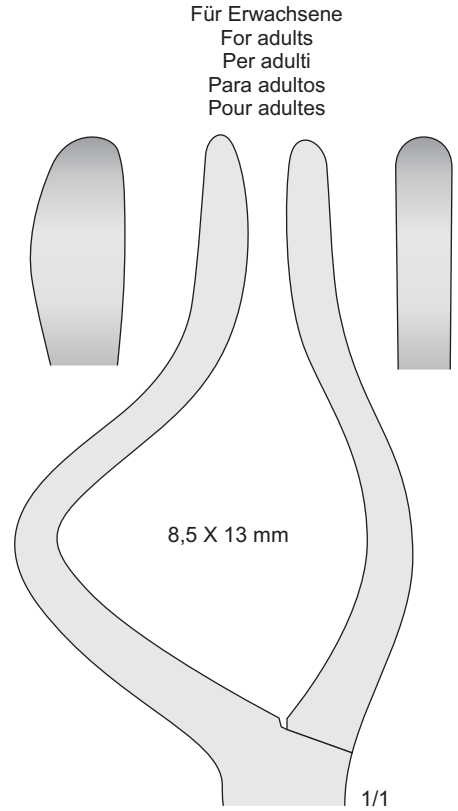

DO-14 L
DO-15 R
240 mm

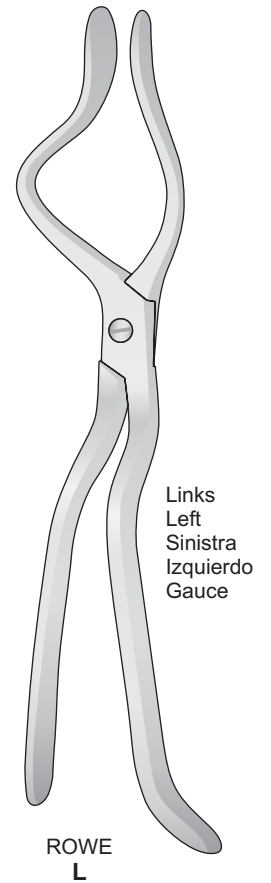
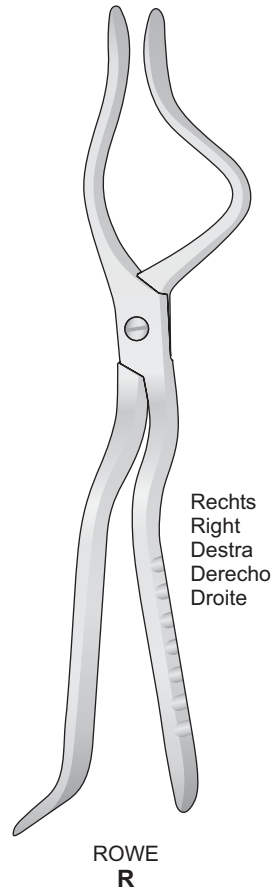
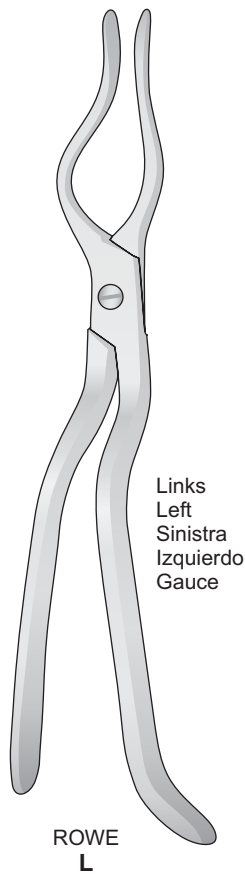
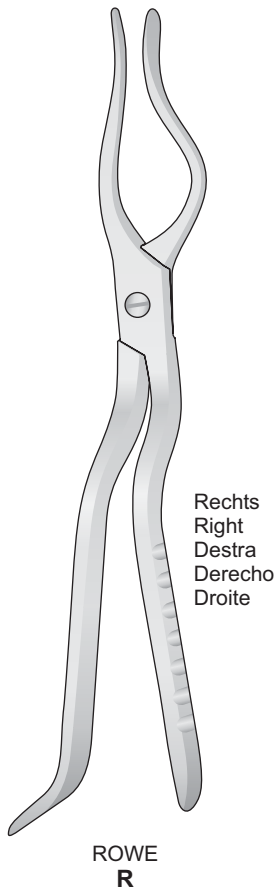

Rhinologie
Septumzangen

Rhinology
Septum Forceps

Rinologia
Pinze per setto nasale

Rinología
Pinzas para tabique
nasal

Rhinologie
Pincés pour la cloison
nasale

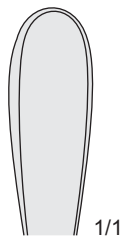
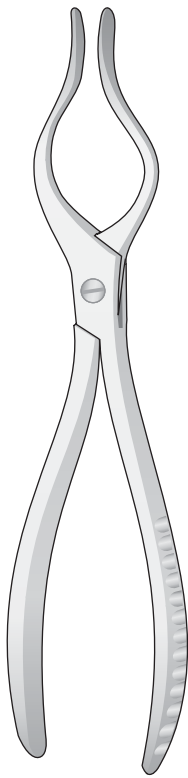

DO-147

Links
Left
Sinistra
Izquierdo
Gauce

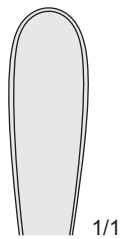

DO-148

Gerade
Straight
Diritto
Recto
Droite

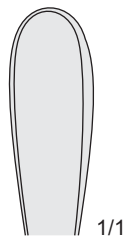

DO-149

Rechts
Right
Destra
Derecho
Droite

COTTLE-WALSHAM
DO-147/DO-149
230 mm

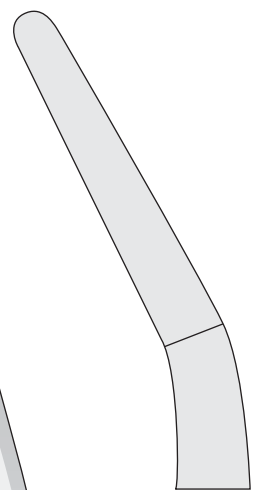
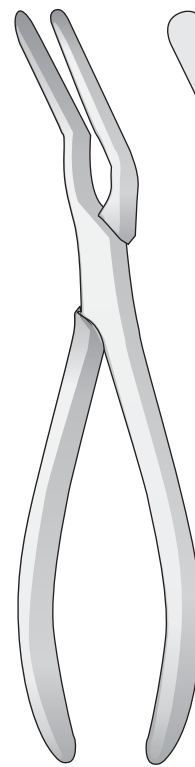

1/1

ASCH
DO-157
230 mm

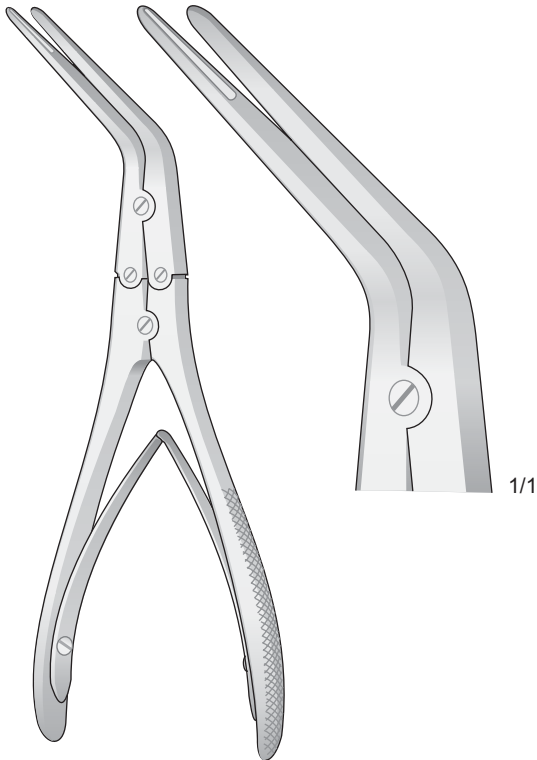

KRESSNER
FO-141
200 mm

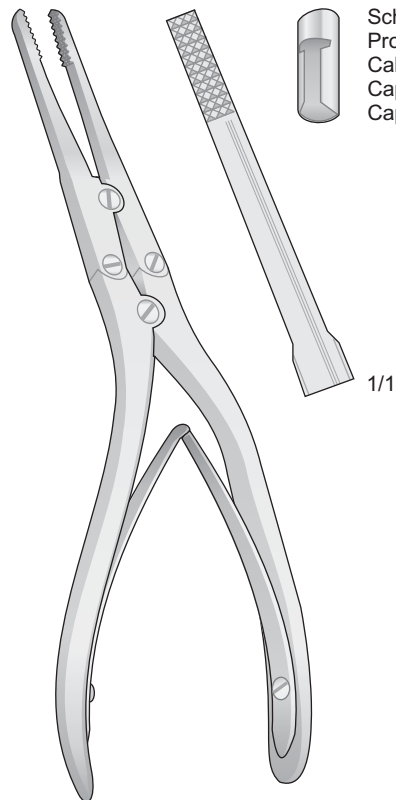

Schutzkappe
Protection Cap
Calotta protettiva
Caperuza protectora
Capuchon protecteur

1/1

RUBIN
FO-142
210 mm

Rhinologie

Rhinology

Rinologia

Rinología

Rhinologie

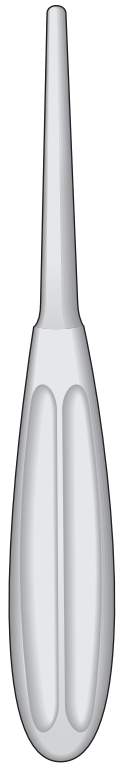

Stumpf
Blunt
Smussa
Romo
Mousse

Septumfraktur-Elevatorium
Septum Displacer
Elevatore per fratture del setto
Elevador para fracturas
del tabique nasal
Elévateur pour fractures
de la cloison nasale

**GOLDMANN
DO-288**
200 mm

10 mm

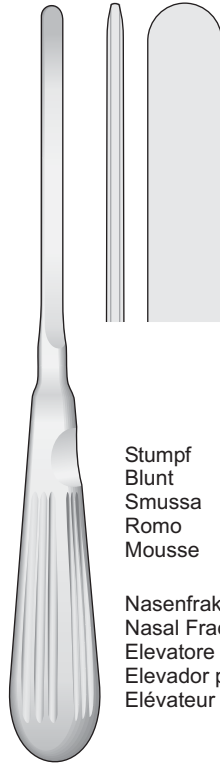

Stumpf
Blunt
Smussa
Romo
Mousse

Nasenfraktur-Elevatorium
Nasal Fracture Elevator
Elevatore per fratture nasalì
Elevador para fracturas nasales
Elévateur pour fractures nasales

**BOIES
DO-289**
200 mm

Septum bone cutting and
breaking forceps curved to the left,
sharp spoons

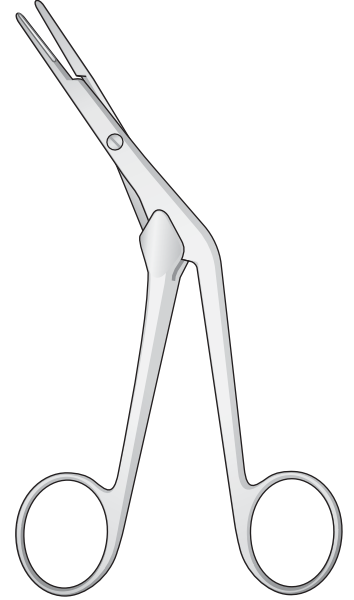

**CRAIG
FO-490**
165 mm

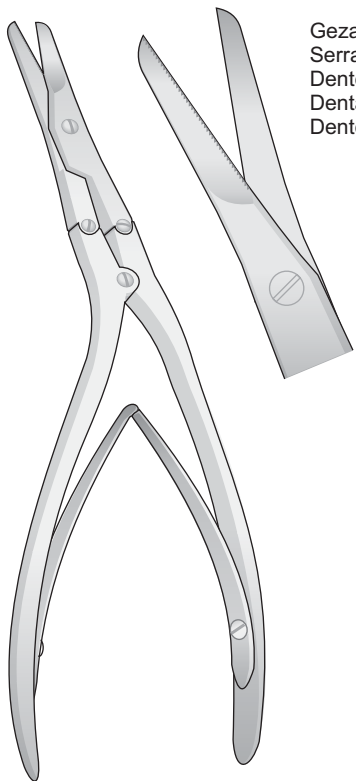

Gezahnt
Serrated
Dentellata
Dentada
Dentéle

**CAPLAN
FO-144**
200 mm

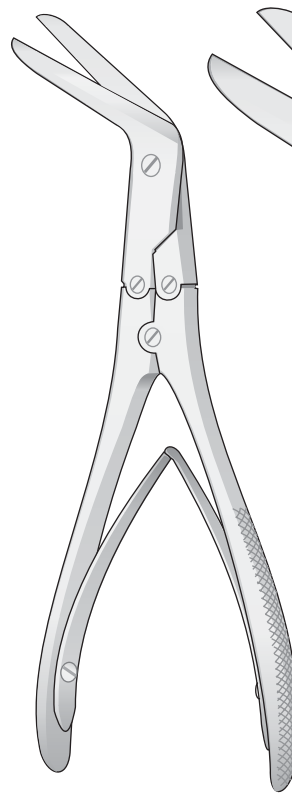

**KILLIAN
FO-143**
210 mm

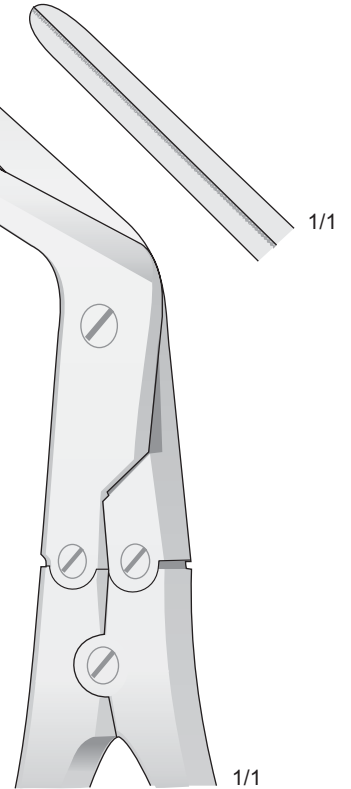

11

Absaugkanülen, Nagelzangen
Suction tubes, Nail Nippers
Cannule per aspirazione, Tronchesi per unghie
Cánulas aspiradores, Pinzas para uñas
Canule aspiratrices, Pincas pour ongles

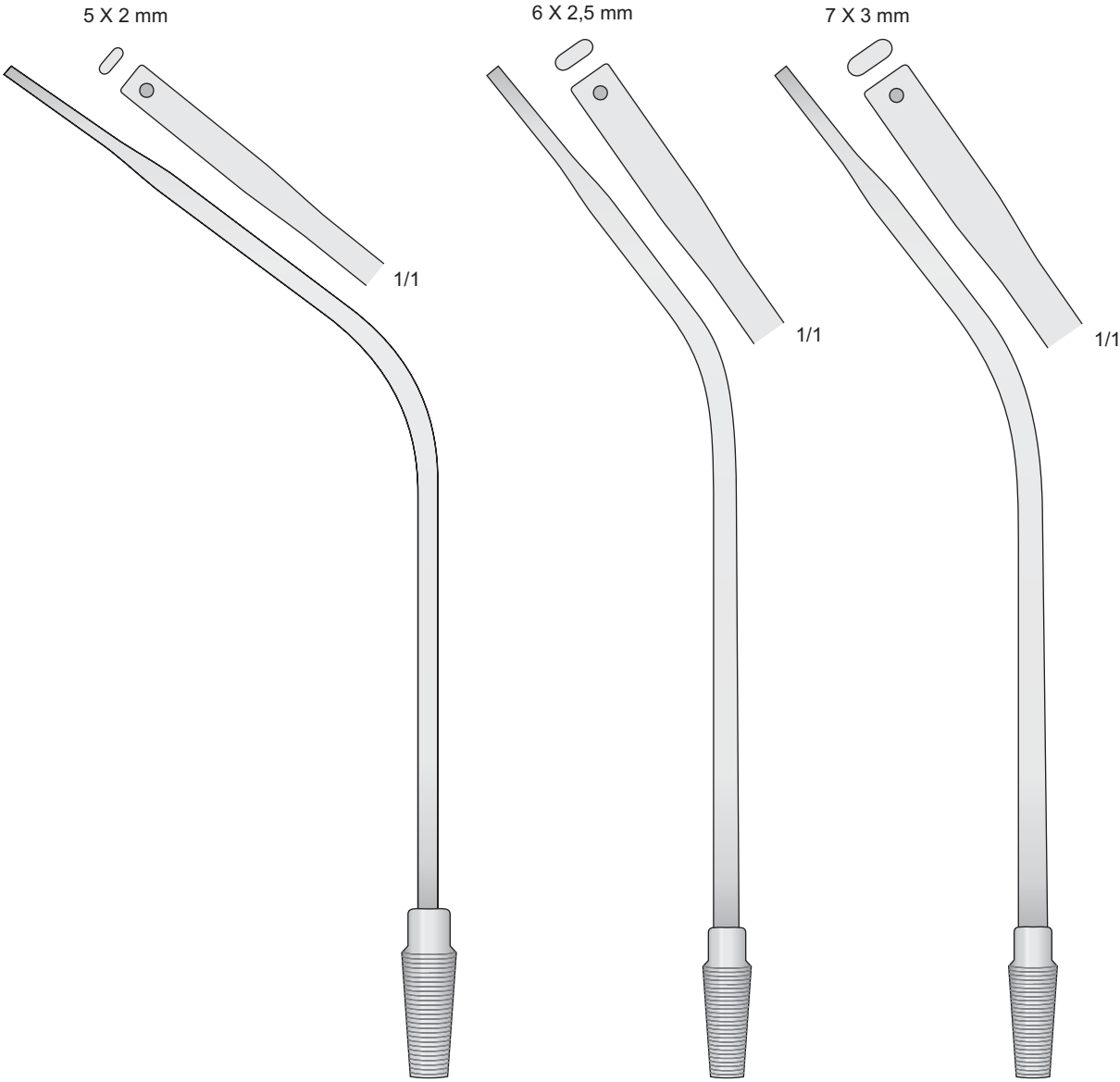

GF-75
190 mm

GF-76
200 mm

GF-77
200 mm

Absaugkanülen

Suctions tubes

Cannule per aspirazione

Cánulas aspiradoras

Canules aspiratrices

Rostfrei
Stainless steel
Acciaio chirurgico
Acero
Acier

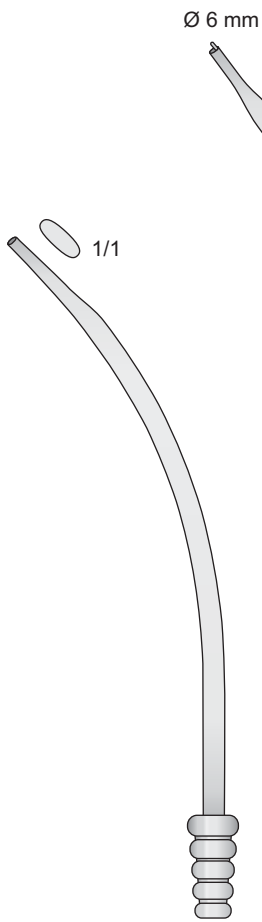

GF-20
180 mm

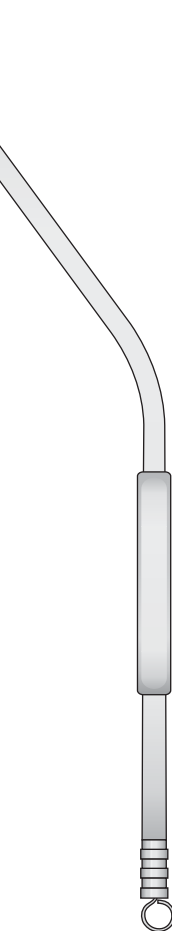

GF-104
240 mm



GF-110
230 mm

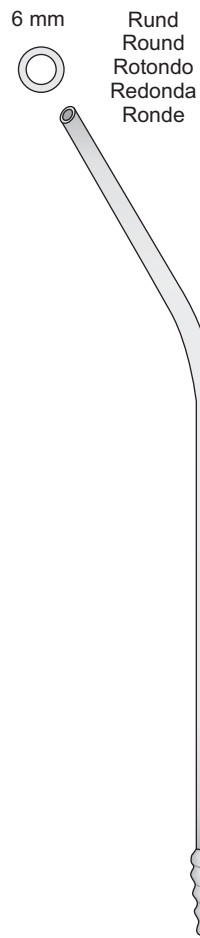

NUBOER
GF-98
210 mm



NUBOER
GF-99
210 mm

Saugraspatorium Scharf - Raspatories, Scharp
Raschietti taglienti - Raspador cortante - Rugine tranchante

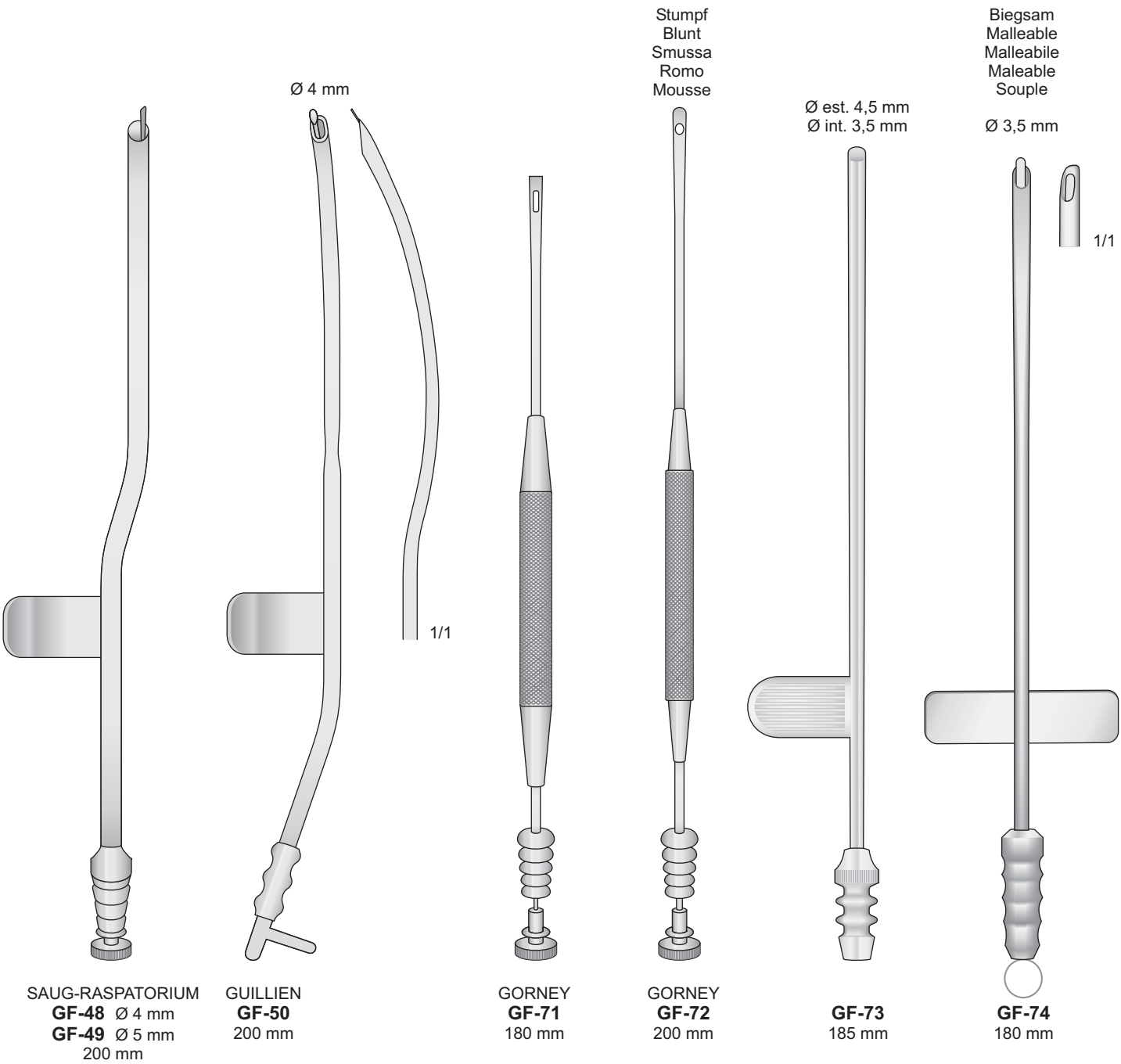

Char. 6	= 2 mm
Char 7	= 2,5 mm
Char 9	= 3 mm
Char 10	= 3,3 mm
Char 12	= 4 mm
Char 15	= 5 mm

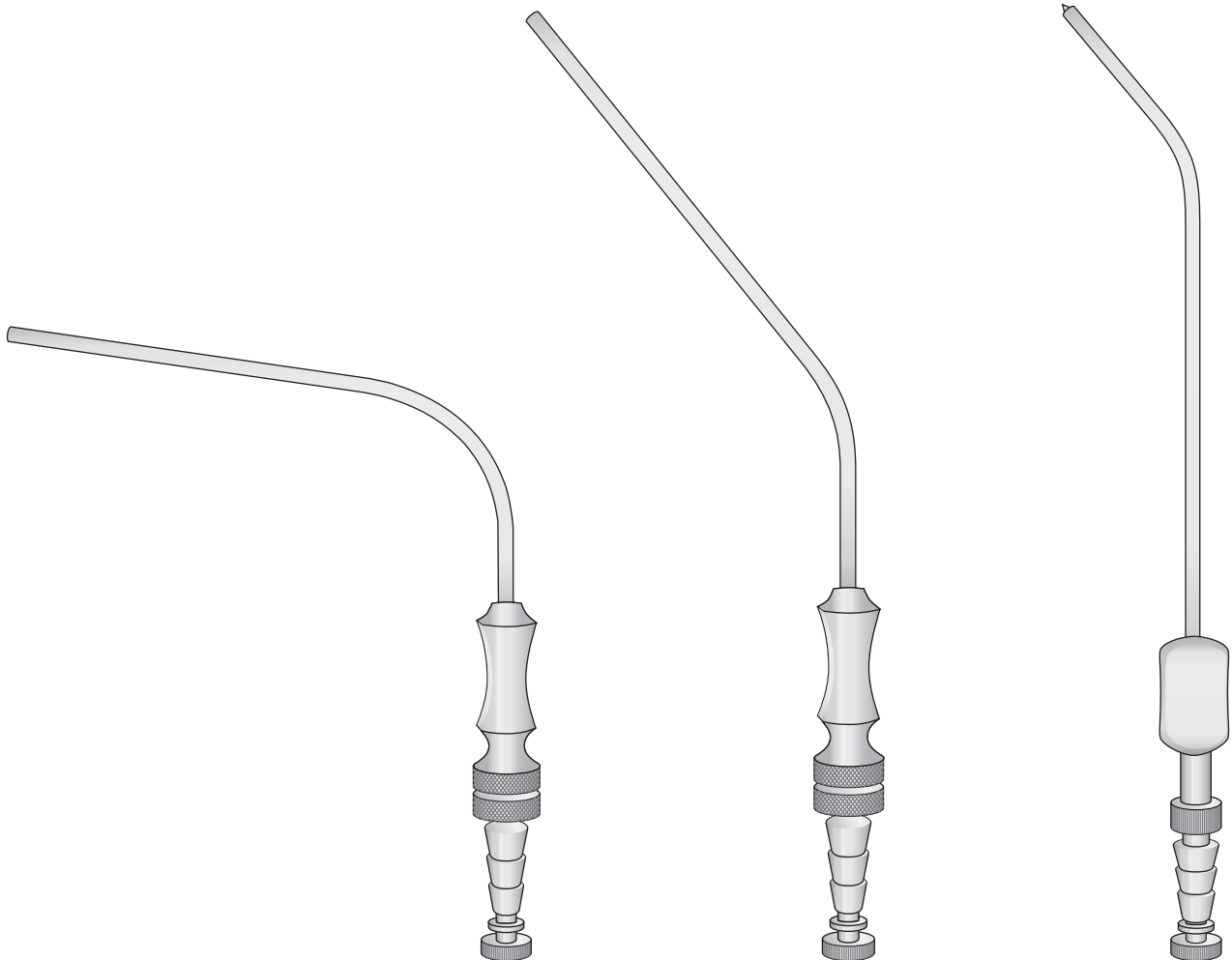

FERGUSON
GF-140 Ch. 6
GF-141 Ch. 7
GF-142 Ch. 9
GF-143 Ch. 12
GF-144 Ch. 15
 180 mm

FRAZIER
GF-240 Ch. 6
GF-241 Ch. 7
GF-242 Ch. 9
GF-243 Ch. 12
GF-244 Ch. 15
 180 mm

PLESTER
GF-150 Ch. 6
GF-151 Ch. 7
GF-152 Ch. 9
GF-153 Ch. 12
GF-154 Ch. 15
 200 mm

Char. 3	= 1 mm
Char 5	= 1,7 mm
Char 7	= 2,5 mm
Char 10	= 3,3 mm
Char 12	= 4 mm

Mit Unterbrecherplatte
With finger cut-off
Con placca d'interruzione
Con placa desconectadora
Avec plaque interruptrice



**BELLUCCI
GF-232**
Charr. 5

**BARON
GF-43**
Charr. 3

**BARON
GF-45**
Charr. 5

**BARON
GF-47**
Charr. 7

**BARON
GF-63**
Charr. 3

**BARON
GF-65**
Charr. 5

**BARON
GF-67**
Charr. 7

House Saug- und Spülrohr, Luer Konus

Saugrohr
Suction tube
Tubo per aspirazione
Tube d'aspiration

Spülrohr
Irrigation tube
Tubo per irrigazione
Tube d'irrigation

Char. 3	= 1 mm
Char 5	= 1,7 mm
Char 7	= 2,5 mm
Char 10	= 3,3 mm
Char 12	= 4 mm
Char 14	= 4,6 mm

Char. 2	= 0,6 mm
Char 4	= 1,21 mm
Char 5	= 1,7 mm
Char 7	= 2,5 mm
Char 8	= 2,4 mm
Char 12	= 4 mm

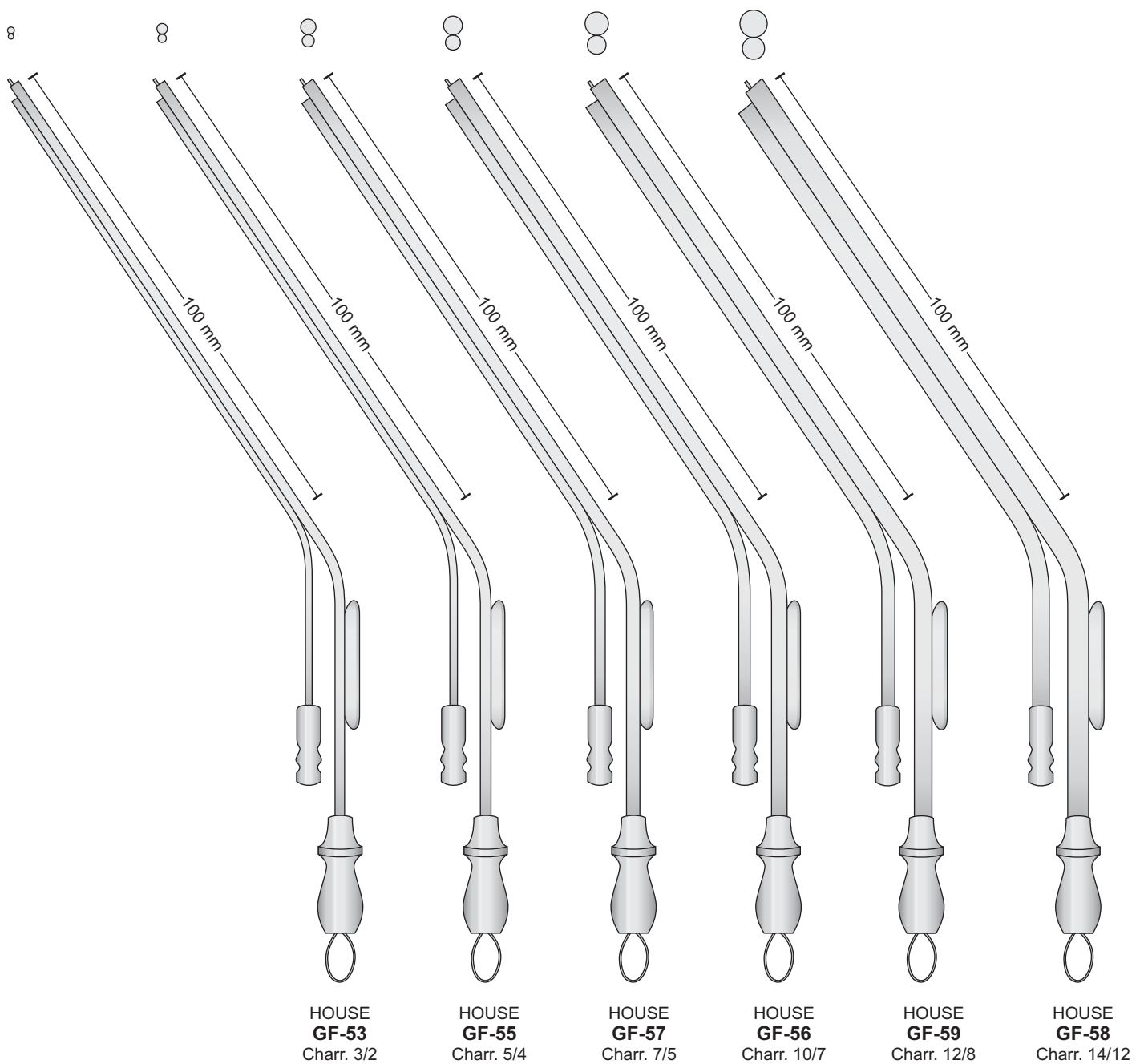

Absaugkanülen

Suctions tubes

Cannule per aspirazione

Cánulas aspiradoras

Canules aspiratrices

Oberfläche Geschwärzt
Surface Black-finish
Superficie colorata nera
Surface noireie

Oberfläche Geschwärzt
Surface Black-finish
Superficie colorata nera
Surface noireie

Biegsam
Malleable
Malleabile
Malleable
Malléables
Ø 3 mm

Biegsam
Malleable
Malleabile
Malleable
Malléables
Ø 3 mm

Biegsam
Malleable
Malleabile
Malleable
Malléables
Ø 3 mm

Biegsam
Malleable
Malleabile
Malleable
Malléables
Ø 3 mm

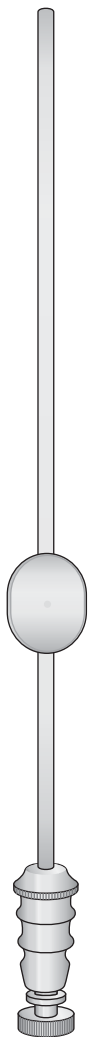

WERTHEIMER
GF-69
160 mm

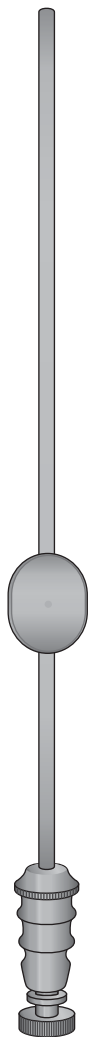

FRAZIER
GF-70
160 mm

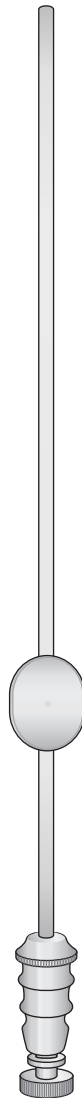

WERTHEIMER
GF-60
200 mm

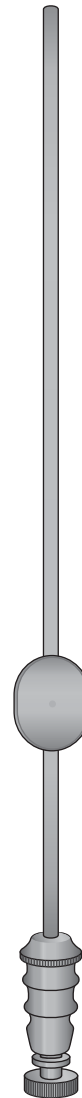

FRAZIER
GF-61
200 mm

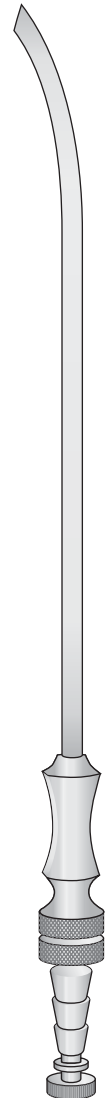

ADSON
GF-41 ch. 12 = Ø 4 mm
GF-42 ch. 15 = Ø 5 mm
210 mm

GF-97
 Komplettsset mit:
 Set complete with:
 Set completo con:
 Set completos con:
 Set complet avec:
GF-92 - GF-93 - GF-94 - GF-96

Gummiball - Rubber bulb
 Pompetta in gomma - Pera de goma
 Poire en caoutchouc

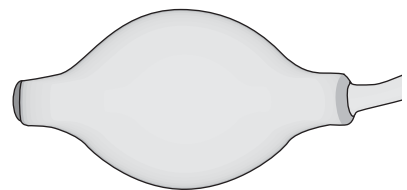

GF-96

Schlauch - Silikon
 Flexible tube - Silicone
 Raccordo in silicone per cannule
 Autoclavabile
 Tubo flexible de silicona
 Tuyau - Silicone

2 mt.

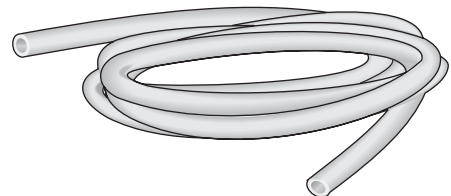

TS-50
2 mt.

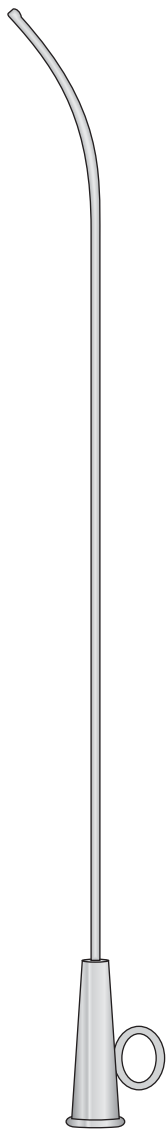

HARTMANN
GF-111/GF-113
 170 mm

GF-111 - Ø 1,5 mm
GF-112 - Ø 2 mm
GF-113 - Ø 2,5 mm



GF-94
 160 mm

Ø 4 mm

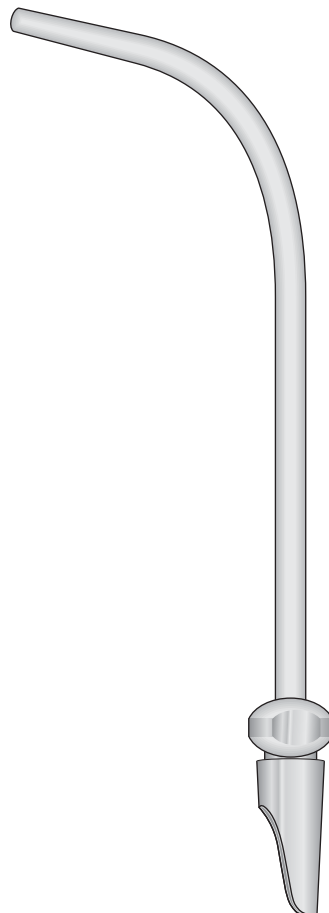

GF-93
 145 mm

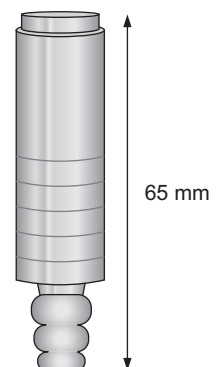

GF-92
 65 mm

Absaugkanülen

Suctions tubes

Cannule per aspirazione

Cánulas aspiradoras

Canules aspiratrices

Kiefer und Stirnhöhlen-Spülkanülen
Antrum and frontal sinus wash cannulas
Cannule per lavaggio dei seni frontali e mascellari
Cánulas lavadores para seno maxilar y seno frontal
Canules pour le lavage du sinus maxillaire et frontal

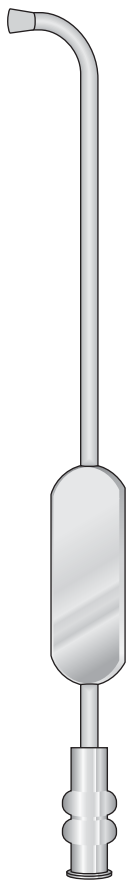

KILLIAN
GF-85 Ø 3 mm
GF-87 Ø 4 mm
145 mm

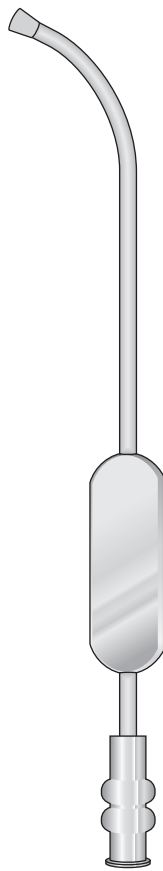

KILLIAN
GF-86 Ø 3 mm
GF-88 Ø 4 mm
145 mm

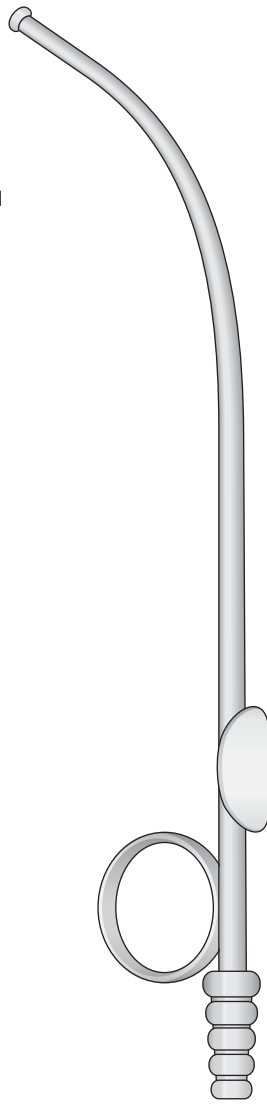

GF-256 Ø 4,5 mm
GF-257 Ø 5,5 mm
175 mm

Ø Innen
Ø Inside
Ø Interno
Ø Interior
Ø Intérieur

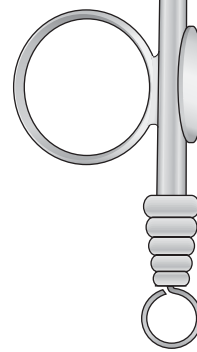

MAGILL
GF-100 Ø 1 mm
200 mm

Ø Innen
Ø Inside
Ø Interno
Ø Interior
Ø Intérieur

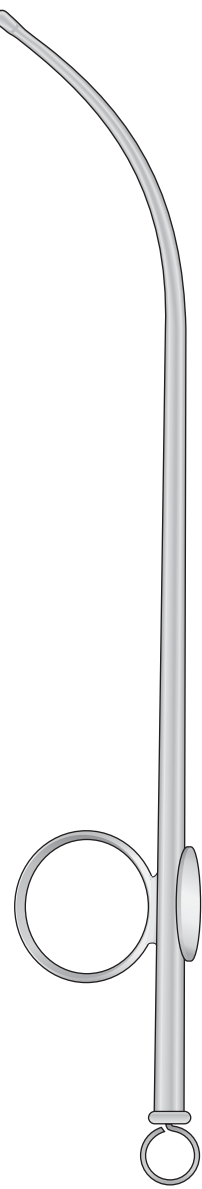

MAGILL
GF-101 Ø 1 mm
GF-102 Ø 2 mm
GF-103 Ø 3 mm
200 mm

Mikro
Absaugkanülen

Micro
Suctions Tubes

Micro cannule
per aspirazione

Micro Cànulas
aspiradoras

Micro Canules
aspiratrices

Infiltration Kanüle
Infiltration Cannula
Aghi-Cannula da infiltrazione
Aguja de infiltración
Aiguille pour infiltration

6 Loch
6 Openings
6 Fori
6 Bucos
6 Troux
Ø 1,5 mm

6 Loch - 6 Openings
6 Fori - 6 Bucos
6 Troux
Ø 1,5 mm

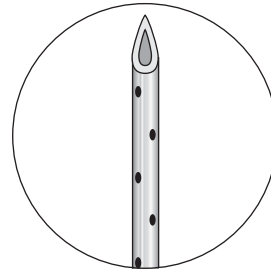

6 Loch
6 Openings
6 Fori
6 Bucos
6 Troux
Ø 1,3 mm

Ø 2,5 mm

Ø 2 mm

Ø 3 mm

Ø 2 mm

Ø 3 mm

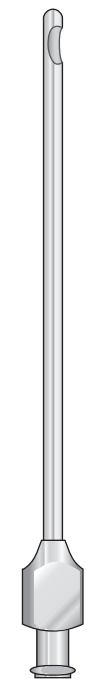

ES-05
70 mm

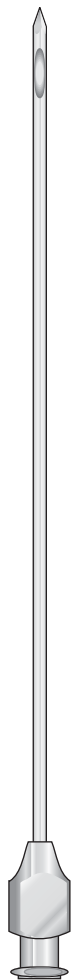

ES-06
110 mm

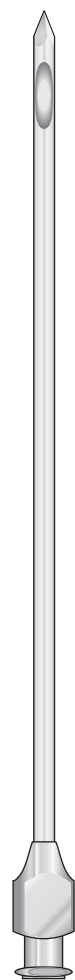

ES-07
110 mm



ES-08
110 mm



ES-09
110 mm

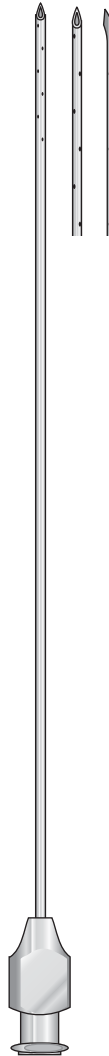



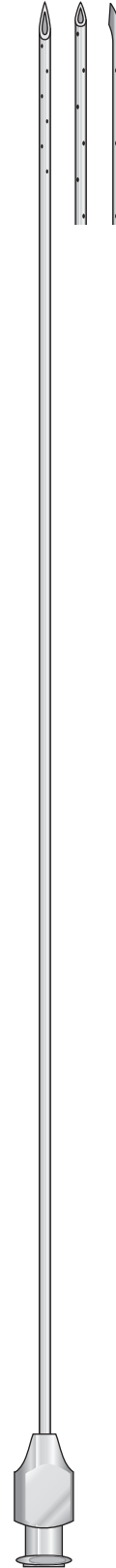



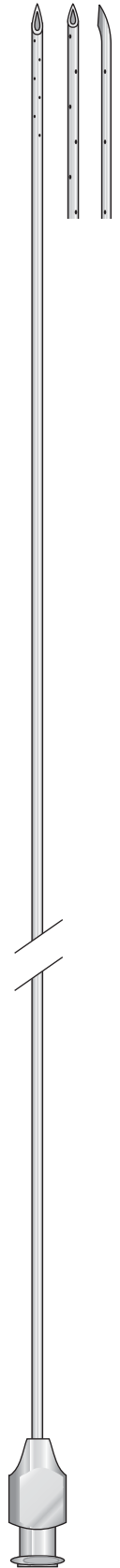



ES-34
120 mm



ES-35
200 mm



ES-36
270 mm

Mikro Absaugkanülen	Micro Suctions Tubes		Micro cannule per aspirazione	Micro Cànulas aspiradoras		Micro Canules aspiratrices			
	Infiltration Kanüle Infiltration Cannula Aghi-Cannula da infiltrazione Aguja de infiltración Aiguille pour infiltration		10 Loch 10 Openings 10 Fori 10 Bucos 10 Troues Ø 1.5 mm	3 Loch 3 Openings 3 Fori 3 Bucos 3 Troues Ø 2.0 mm	5 Loch 5 Openings 5 Fori 5 Bucos 5 Troues Ø 3.0 mm	2 Loch 2 Openings 2 Fori 2 Bucos 2 Troues Ø 3.0 mm	5 Loch - 5 Openings 5 Fori - 5 Bucos 5 Troues Ø 2.0 mm	5 Loch - 5 Openings 5 Fori - 5 Bucos 5 Troues Ø 2.0 mm	
	7 Loch 7 Openings 7 Fori 7 Bucos 7 Troues Ø 1,5 mm	2 Loch 2 Openings 2 Fori 2 Bucos 2 Troues Ø 2,0 mm							
5 Loch 5 Openings 5 Fori 5 Bucos 5 Troues Ø 1,5 mm									
									
ES-41 100 mm	ES-51 150 mm	ES-52 150 mm	ES-53 150 mm	ES-54 200 mm	ES-55 200 mm	ES-56 200 mm	ES-59 200 mm	ES-57 300 mm	ES-58 300 mm

Makro
Absaugkanülen

Macro
Suctions Tubes

Macro cannule
per aspirazione

Macro Cánulas
aspiradoras

Macro Canules
aspiratrices

1 Loch - 1 Opening
1 Foro - 1 Bucos
1 Trou

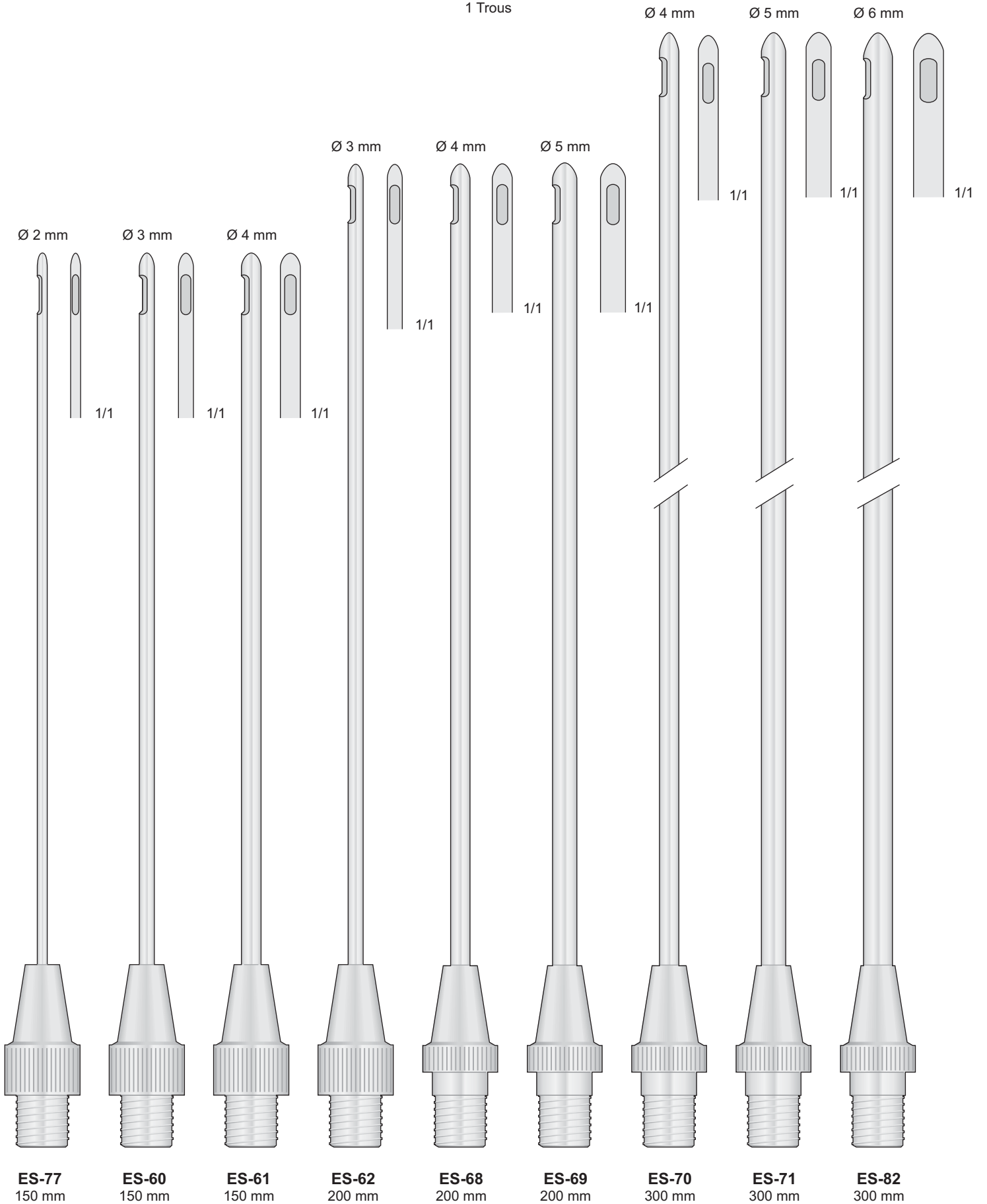

Makro
Absaugkanülen

Macro
Suctions Tubes

Macro cannule
per aspirazione

Macro Cànulas
aspiradoras

Macro Canules
aspiratrices

3 Loch - 3 Openings
3 Fori - 3 Bucos
3 Trous

Ø 3 mm

Ø 4 mm

Ø 5 mm

Ø 6 mm

Ø 3 mm

Ø 4 mm

Ø 3 mm

Ø 3 mm

Ø 4 mm

1/1

1/1

1/1

1/1

1/1

1/1

1/1

1/1

1/1

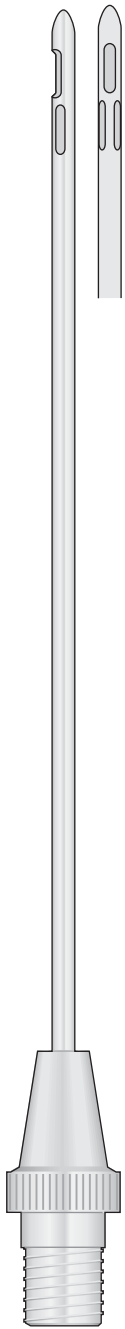

ES-83
150 mm

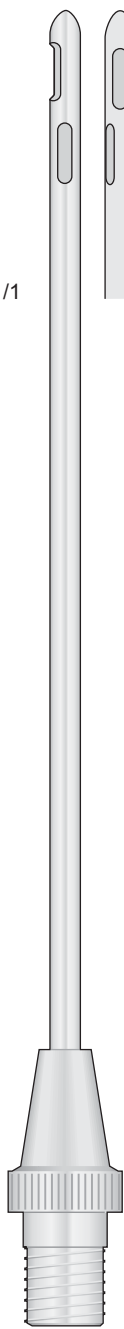

ES-84
150 mm

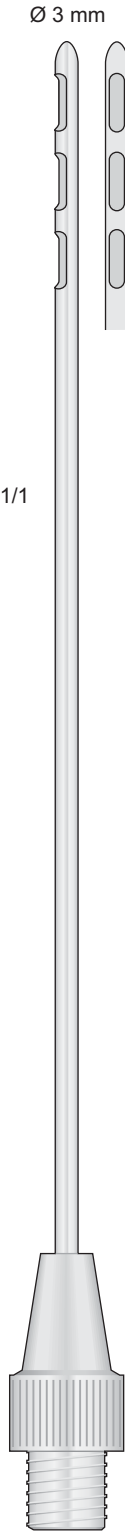

ES-79
200 mm

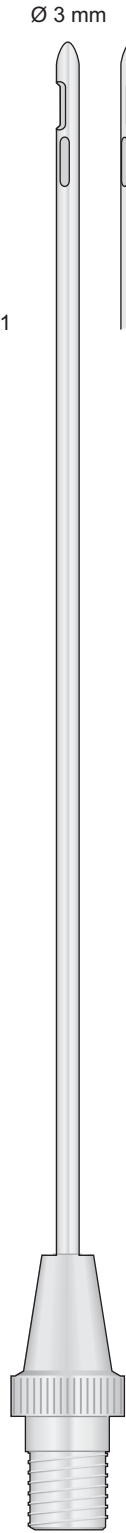

ES-85
200 mm

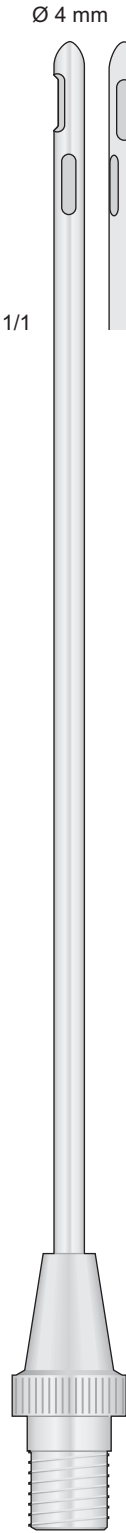

ES-63
200 mm

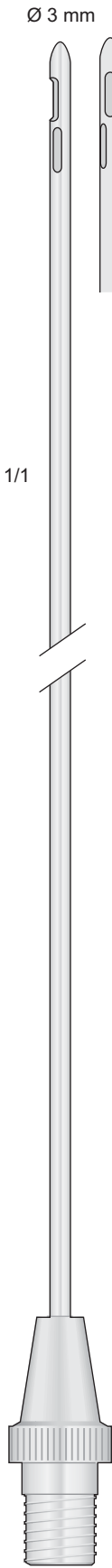

ES-66
300 mm

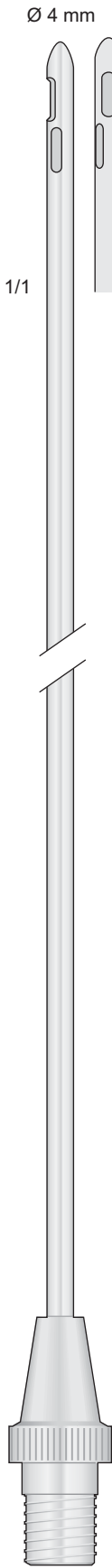

ES-67
300 mm

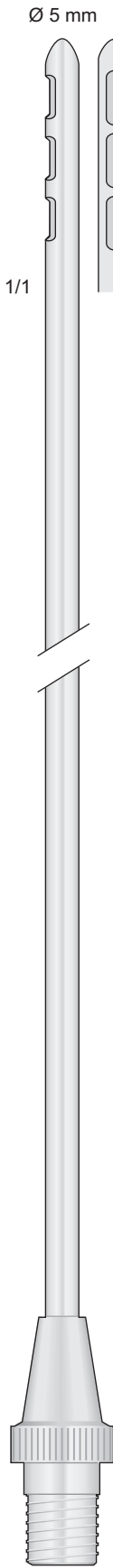

ES-76
300 mm

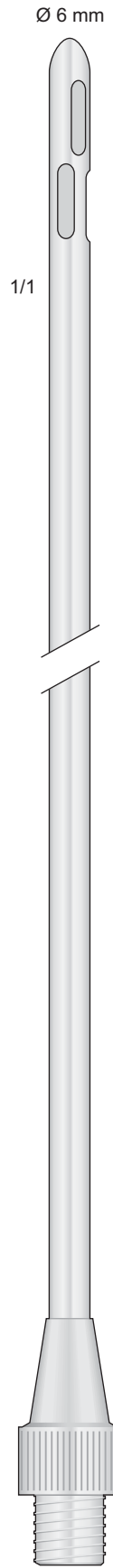

ES-81
300 mm

Makro
Absaugkanülen

Macro
Suctions Tubes

Macro cannule
per aspirazione

Macro Cànulas
aspiradoras

Macro Canules
aspiratrices

2 Loch - 2 Openings
2 Fori - 2 Bucos
2 Troux

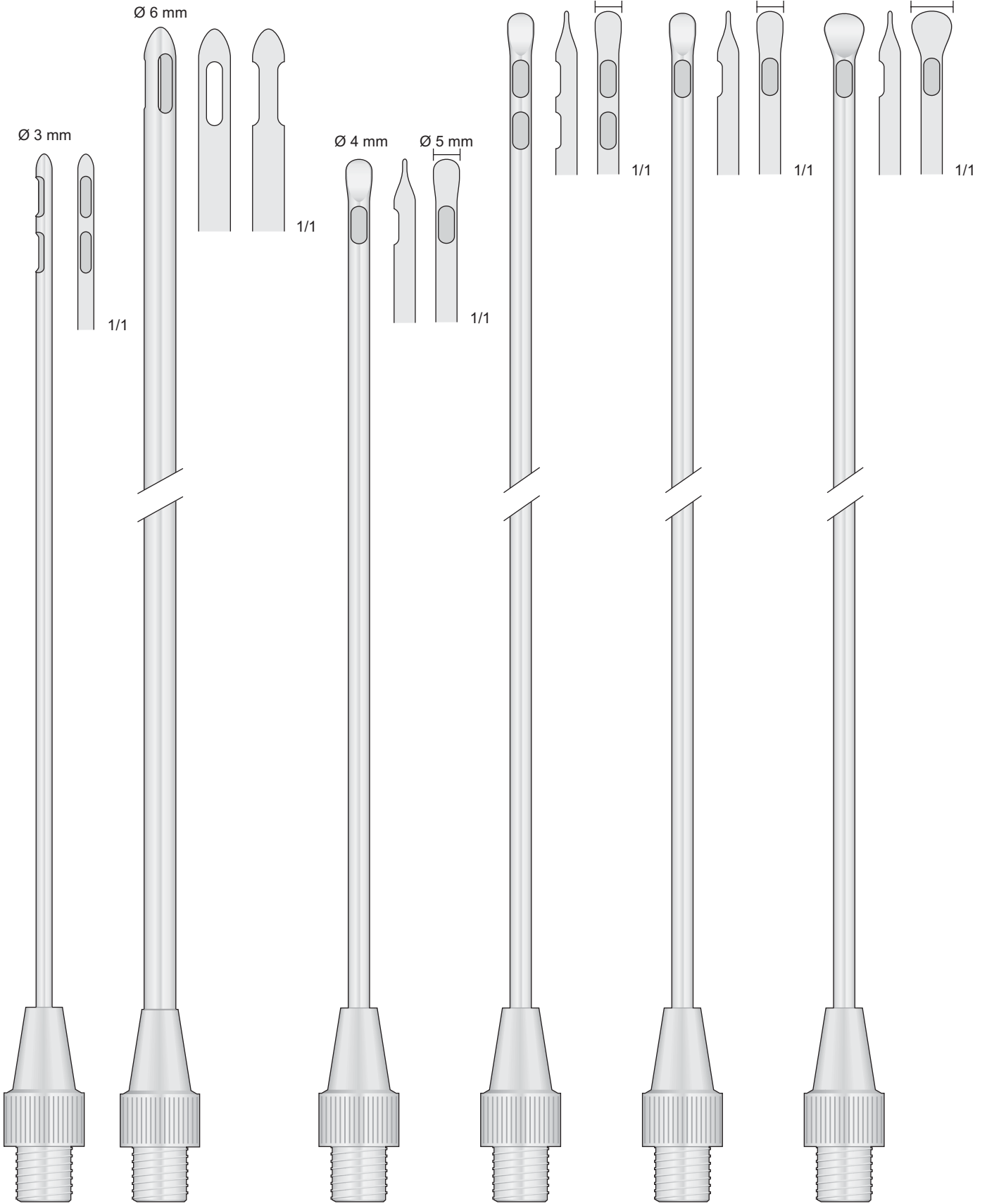

ES-78
200 mm

ES-80
300 mm

ES-72
200 mm

ES-73
300 mm

ES-74
300 mm

ES-75
300 mm

Makro
Absaugkanülen

Macro
Suctions Tubes

Macro cannule
per aspirazione

Macro Cànulas
aspiradoras

Macro Canules
aspiratrices

Biegsam - Malleable
Malleabile - Maleable - Souple

Ø 4 mm Ø 5 mm

Biegsam
Malleable
Malleabile
Maleable
Souple

Ø 3 mm

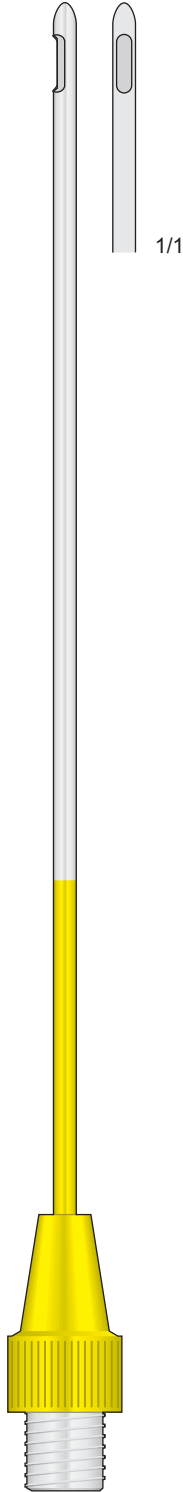

ES-92
200 mm

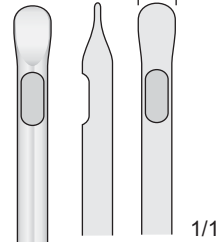

ES-102
300 mm

Alu-Griff
Aluminium Handle
Manico in Alluminio
Mango de aluminio
Manche à aluminium

Ø 18 mm

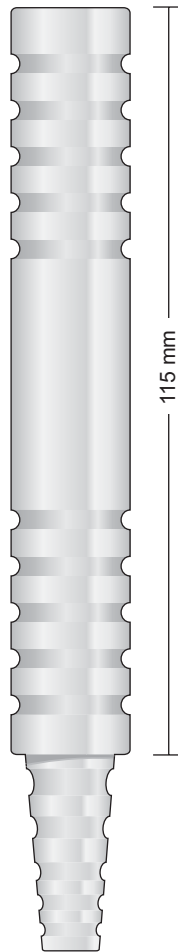

ES-39
145 mm

Griff Rostfrei
Stainless Steel Handle
Manico in acciaio Inox
Mango de acero
inoxidable
Manche en
acier inoxydable

Ø 15 mm

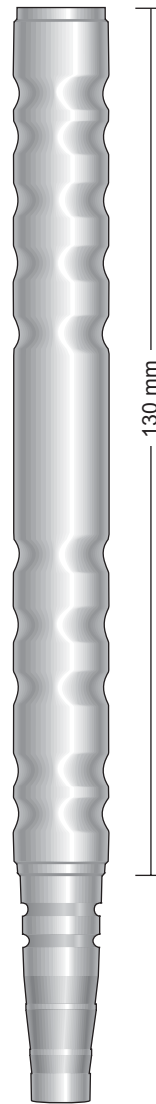

ES-49
165 mm

Alu-Griff Blau
Blue Aluminium Handle
Manico in Alluminio blu
Mango à aluminium azul
Manche de aluminium bleu

Ø 18 mm

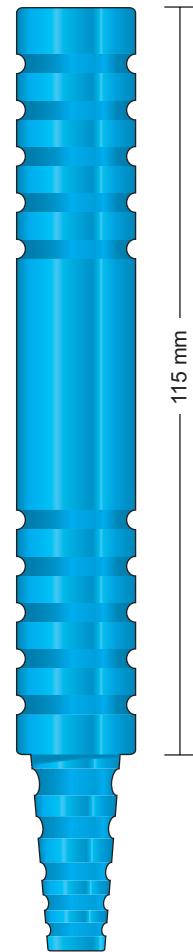

ES-50
145 mm

The **LUER-LOCK**
to **LUER-LOCK**
Transfer System

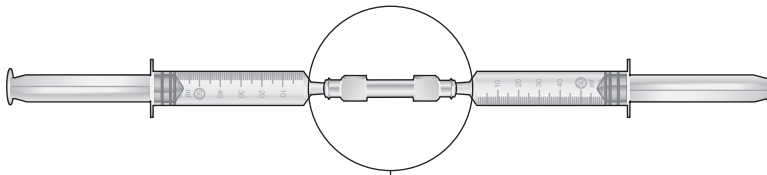

Spritzenstop, zur Gewinnung
eines Vakuums in der Spritze
Stop for syringes,
lock maintains vacuum in the syringe
Stop per siringhe
Stop pour siringe

Rostfreies Verbindungsteil
zum Spritze
Connection Piece for Suction
Raccordo Inox per siringa
Adapter en acier pour siringe

Ø est. 9 mm

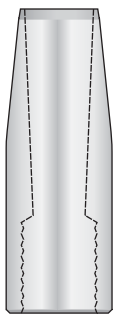

Ø int. 10 mm

ES-01
40 mm

Raccordo per
due siringhe



Luer Lock

Luer Lock

1/1

ES-03
37 mm



ES-111
115 mm



ES-112
115 mm



OL-01
120 mm

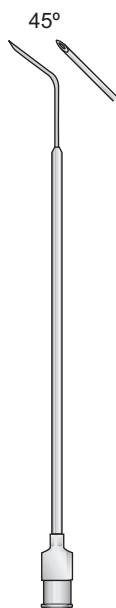

OL-02
110 mm



OL-03
110 mm



OL-04
110 mm

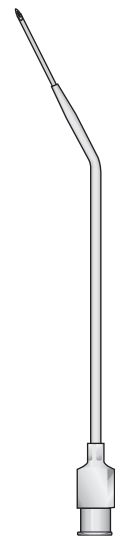

OL-05
110 mm

Nadel für Biopsie
Kanülenreinigungs-
bürsten

Biopsy needles
Cleaning brush for
tubes

Aghi da biopsia
Scovolini per pulizia
cannule

Agujas para Biopsia
Cepillo para limpiar
cánulas

Aiguilles pour Biopsie
Brosse de nettoyage
pour canules

Sterilisier bar
Autoclavable
Autoclavabile
Esterilizabile
Stérilisable

Handwaschbürste
Nail brushes
Spazzola per unghie
Cepillos de uñas
Brosse à ongles



GF-200
4 x 11 cm

Punktionskanülen mit Luer-Lock Ansatz
Puncture needles with Luer-Lock connector
Cannule per puntura con innesto Luer-Lock
Cánulas para punción con cono Luer-Lock
Canules à ponctions avec embout Luer-Lock

Reinigungsbürsten
Cleaning brushes
Spazzole per pulire
Cepillos de limpieza
Brosses à lavement

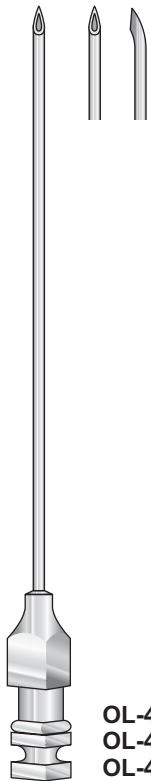

OL-41 - 1,30 x 80 mm
OL-42 - 1,50 x 80 mm
OL-43 - 1,65 x 80 mm

TUOHY
OL-41/OL-43



OL-44 - 0,70 x 80 mm
OL-45 - 0,70 x 90 mm
OL-46 - 1,00 x 80 mm
OL-47 - 1,00 x 90 mm
OL-48 - 1,20 x 90 mm
OL-49 - 1,20 x 100 mm

QUINKE
OL-44/OL-49

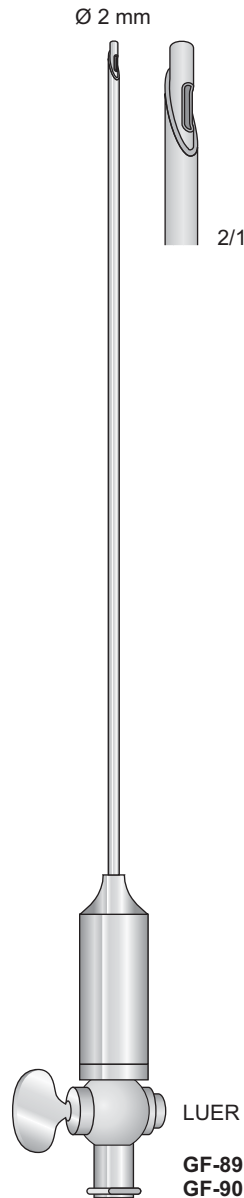

Ø 2 mm
2/1
LUER LOCK
GF-89 120 mm
GF-90 150 mm

VERESS
GF-89/GF-90

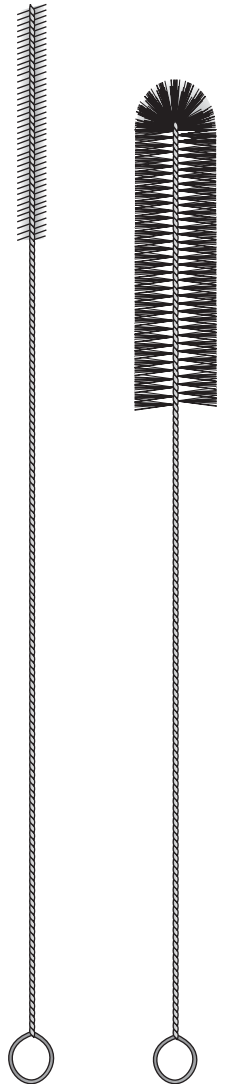

GF-40
235 mm

GF-188
220 mm

Nagelzangen

Nail Nippers

Tronchesi per unghie

Pinzas para cortar uñas

Pinces pour couper ongles

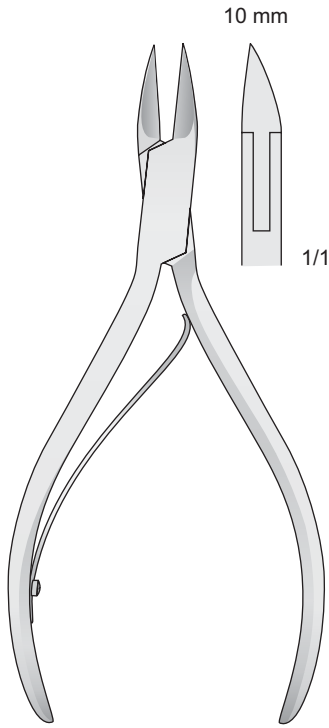

GS-42
100 mm

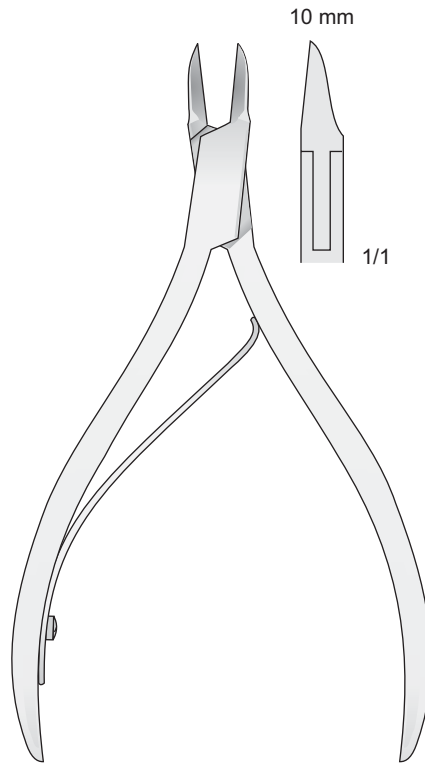

GS-43
110 mm

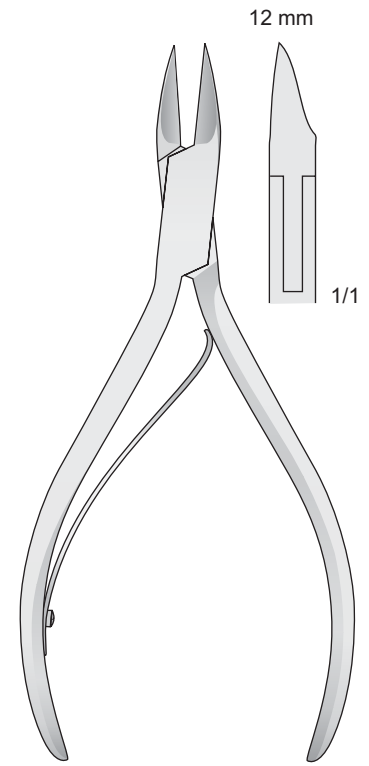

GS-44
110 mm

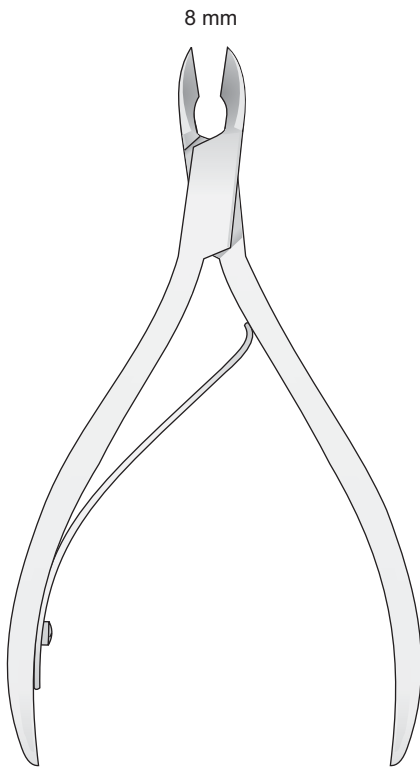

GS-41
110 mm

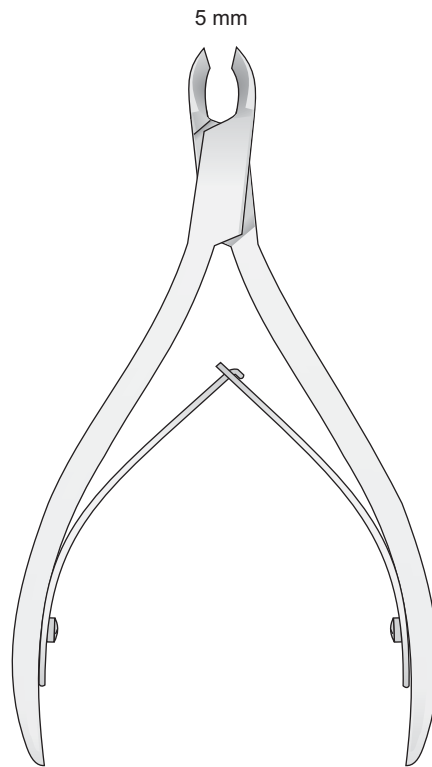

GS-45
110 mm

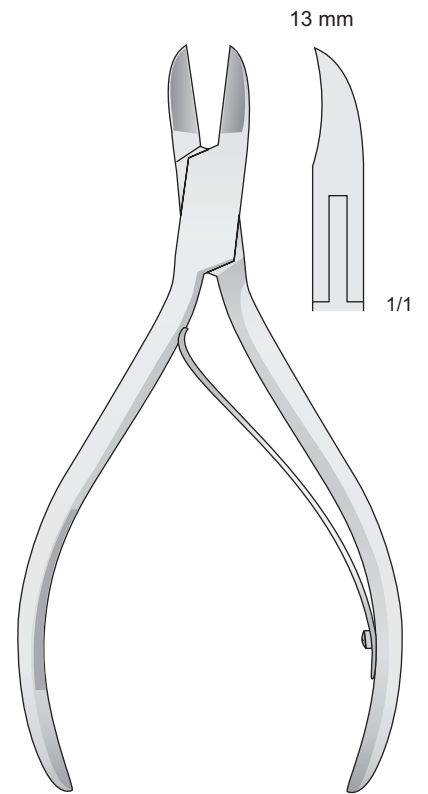

GS-21
120 mm

Nagelzangen

Nail Nippers

Tronchesi per unghie

Pinzas para cortar uñas

Pinces pour couper ongles

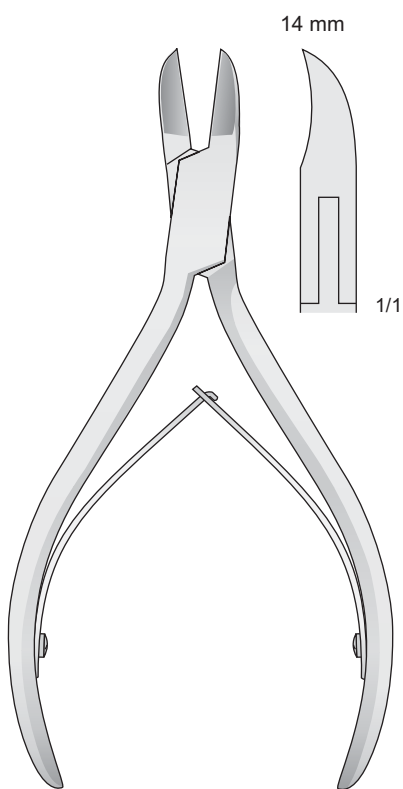

GS-32
120 mm

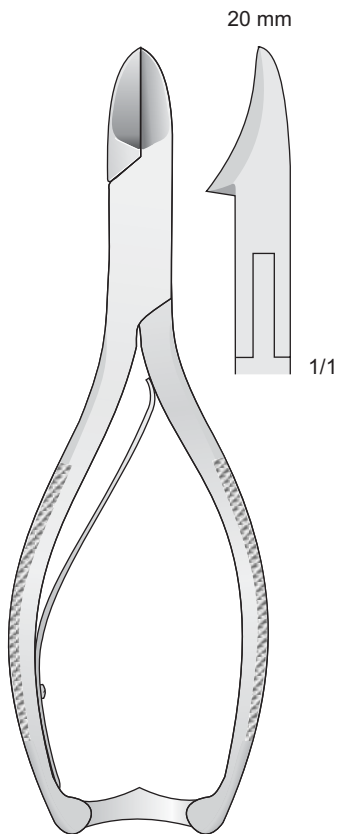

GS-20
135 mm

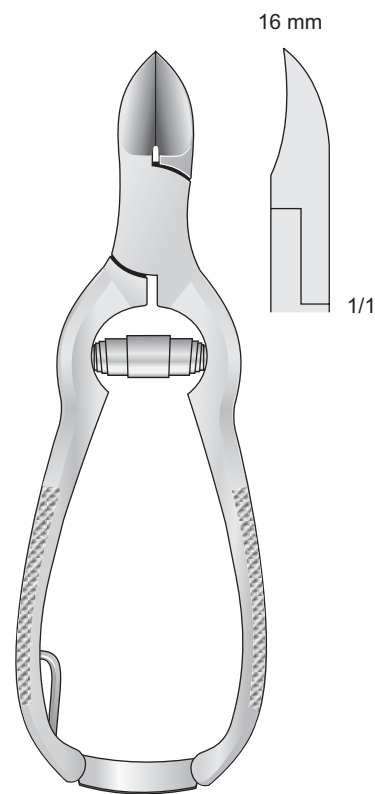

GS-46
120 mm

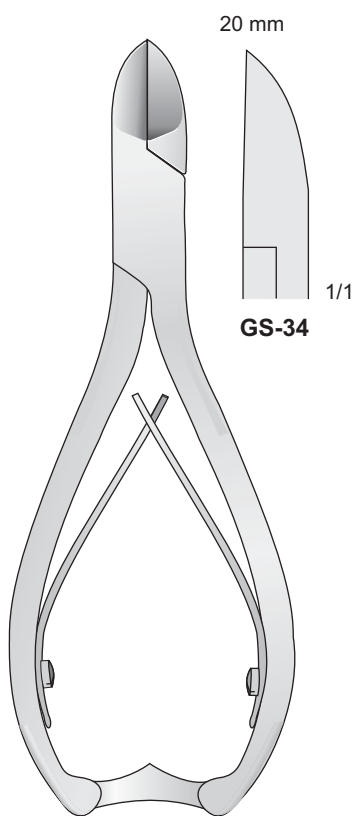

GS-34/GS-35
140 mm

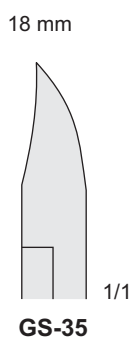

GS-35

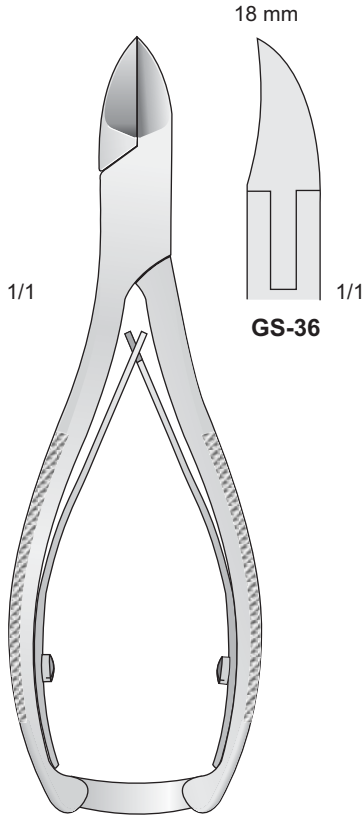

GS-36/GS-48
140 mm

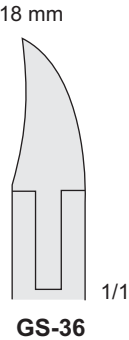

GS-36

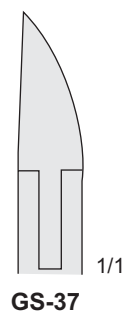

GS-37

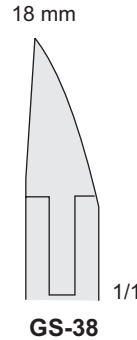

GS-38

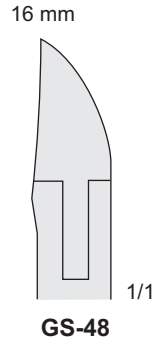

GS-48

Eckenzangen
Fusspflege Instrumente

Nail corner forceps
Chiropody instruments

Tronchesi per unghie
Strumenti per pedicure

Corta uñas
Instrumentos para pedicure

Pinces à ongles
Instruments pour pedicure

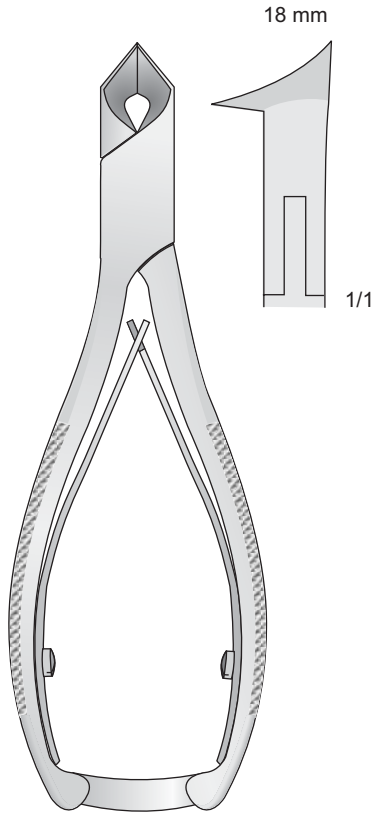

GS-50
135 mm

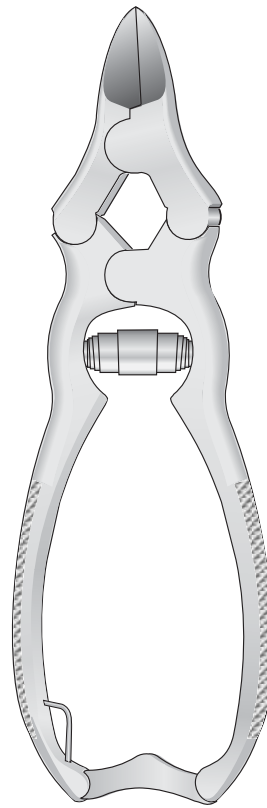

GS-19/GS-22
155 mm

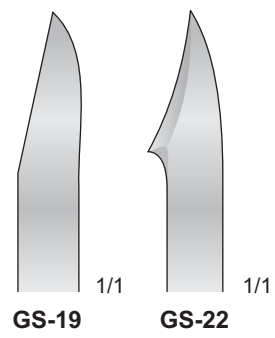

Instrumente für eingewachsene Nägel
Forceps for ingrown nails
Strumento per unghie incarnite
Instrumento para cortar uñas
Pince pour fendre les ongles incarnés

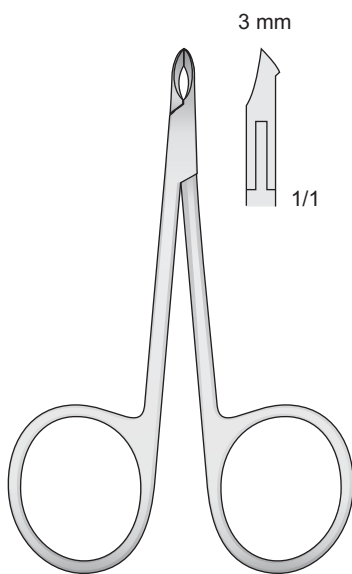

GS-40
85 mm



WARWICK-JAMES
DL-20
155 mm

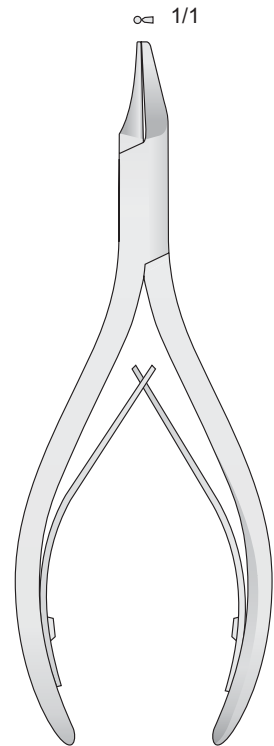

DP-09
135 mm

Instrumentenpflege

Maintenance of instruments

Mantenimento dello strumentario

Mantenimiento del instrumental

Nettoyage d'instruments

Wasserlösliche Schmiermittel von chirurgische Instrumenten
Lubricant Oil for surgical instruments
Olio lubrificante per strumenti chirurgici
Lubrificante para instrumentos
Entretien pour instruments

RODHOIL

Schmiermittel mit hoher Dichte. Es sichert den perfekten Gebrauch und die Leichtgängigkeit aller chirurgischen Instrumente. Man gibt es auf die Verbindungen und Gelenke und in alle beweglichen Teile, die Reibungen unterworfen sind.

RODHOIL

Lubricant to high density. It assures the perfect utility and fluency of all the surgical instruments. For apply in to loosens, join and in all the parts in subject movement subject to attrition.

RODHOIL

Lubrificante ad alta densità. Assicura la perfetta funzionalità e scorrevolezza di tutti gli strumenti chirurgici. Da applicare negli snodi, giunture e in tutte le parti in movimento soggette ad attrito.



DB-OLR
50 cc

Das wasserlösliche Schmiermittel verlängert die Lebensdauer von chirurgische Instrumenten
Soluble lubricant extends useful life of surgical instruments
Lubrificante anticorrosivo e detergente per strumenti chirurgici
Lubrificante soluble en agua, so uso prolonga la duracion de los instrumentos quirurgicos
Lubrifiant soluble dans l'eau prolonge la vie des instruments chirurgicaux

CLEANLACT

Reinigungskonzentrat für chirurgische Instrumente. Es wirkt antibakteriell, nicht-ätzend und schmierig. Es garantiert die perfekte Erhaltung aller Instrumente aus Stahl, entfernt eventuelle Flecken, Ränder, und Bräunungen von Sterilisationen, Desinfektionen und Reinigungen mit hartem Wasser. Es sollte regelmäßig verwendet werden.

CLEANLACT

Product concentrated for surgical instruments. It explains an action anti-corrosive, antibacterium and lubricant. It guarantees the perfect maintenance of all the instruments in steel eliminating eventual stains and burnishes to sterilization, disinfection and to washings with hard waters. It used periodically.

CLEANLACT

Prodotto concentrato per strumenti chirurgici. Esplica un azione anticorrosiva batteriostatica e lubrificante. Garantisce il perfetto mantenimento di tutti gli strumenti in acciaio eliminando eventuali macchie, aloni e bruntiture dovute a sterilizzazioni, disinfezioni e a lavaggi con acque dure. Va usato periodicamente.



DB-50M
500 cc

DB-1L
1000 cc

Abziehsteine zum
schärfen

Accessories for
re-sharpening

Pietre
ed accessori

Pierre et
accessories

Pierre et
accessories

Schleifsteine - Sharpening stones
Pietre di Arkansas per affilatura strumenti
Materiales para afilar - Pierres d'affutage

Schleifstein-Öl
Oil for grinding stones
Olio per affilatura strumenti
Huile d'affutage



DB-299
ARKANSAS
conica n° 299

DB-OL
30 cc

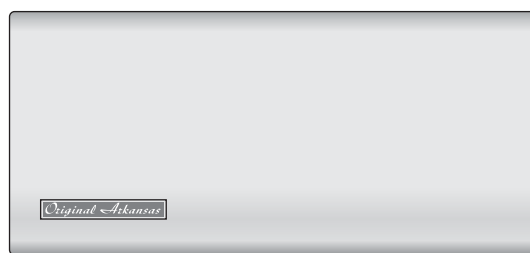

DB-96
ARKANSAS
n° 8

DB-6A
ARKANSAS
n° 6A

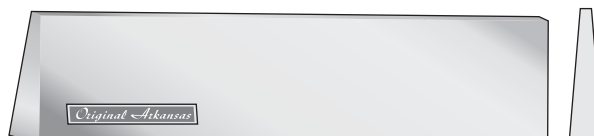

DB-4
ARKANSAS
n° 4

DB-22A
ARKANSAS

Gefäße aus Edelstahl

Stainless Steel
Receptacles

Recipienti in acciaio
inossidabile

Recipientes de acero
inoxidable

Réceptacles en acier
inoxydable

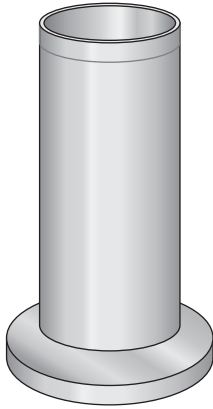

CS-51 Ø 50 mm h 100 mm
CS-52 Ø 50 mm h 150 mm
CS-55 Ø 80 mm h 180 mm

Runder Sterilbehälter mit Ausguss
Lotion bowls capsules
Capsule inox con fondo piano e becco
Cubetas de acero inoxidable
Cuvettes de acier inoxydable

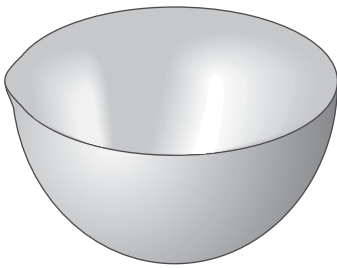

CS-01 Ø 40 mm 15 cc
CS-02 Ø 60 mm 75 cc
CS-03 Ø 80 mm 225 cc
CS-04 Ø 100 mm 325 cc
CS-05 Ø 120 mm 500 cc
CS-06 Ø 150 mm 600 cc

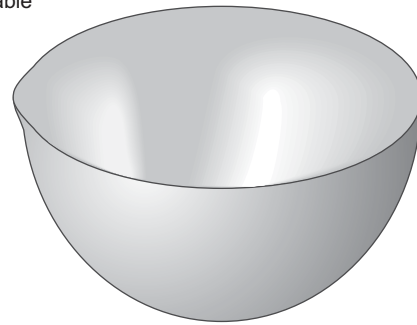

CS-80 Ø 180 mm 1000 cc
CS-81 Ø 200 mm 1450 cc
CS-82 Ø 220 mm 2000 cc
CS-83 Ø 240 mm 3300 cc

Nierenschalen
Kidney bowls
Bacinelle reniformi
Riñoneras
Bassins réniformes



BR-20 200 mm
BR-25 250 mm
BR-28 280 mm

Schalen
Trays
Vassoi porta-strumenti
Bandejas
Bassins



VS-20 210 x 110 x 25 mm
VS-26 250 x 180 x 30 mm
VS-30 300 x 220 x 30 mm

Gefäße aus Edelstahl

Stainless Steel
Receptacles

Recipienti in acciaio
inossidabile

Recipientes de acero
inoxidable

Réceptibles en acier
inoxydable

Nadelkassetten
Needle Cases
Scatole per aghi
Estuches para agujas
Boîtes pour aiguilles

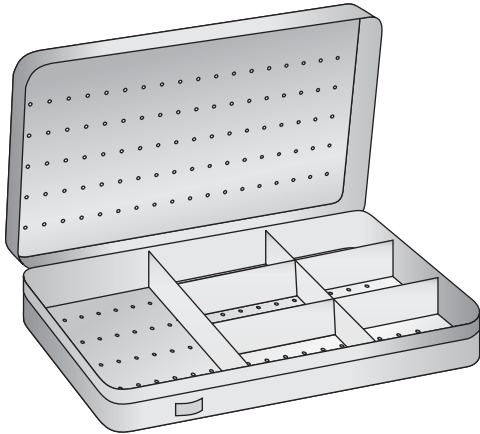

BS-27
150 x 90 x 20 mm

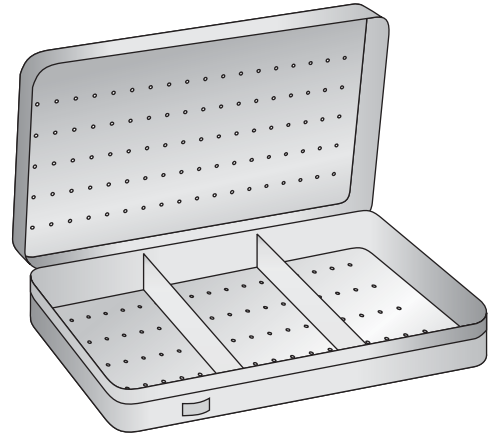

BS-23
150 x 90 x 20 mm

Deckel und Boden perforiert
Perforated lid and bottom
Coperchio e base perforati
Tapa y fondo perforado
Couvercle et fond perforé

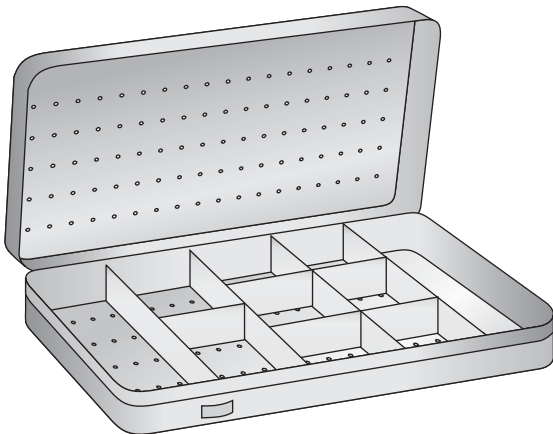

BS-28
220 x 120 x 20 mm

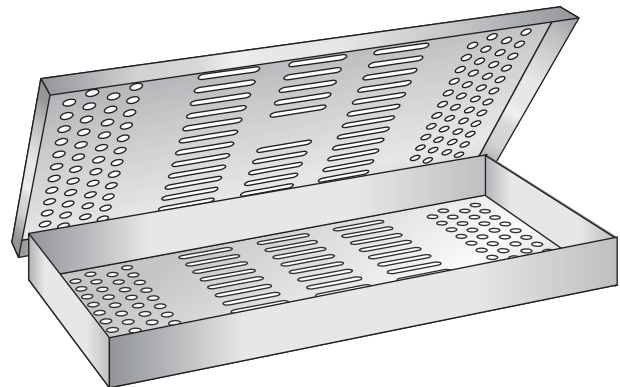

BS-41
275 x 130 x 25 mm

Mit 2 Sterilisiergestelle
With 2 Sterilizing Racks
Con 2 Supporti per sterilizzazione
Con 2 Bastidores para esterilización
Avec 2 Cadres de stérilisation

Mit Sterilisiergestelle und Trenneinteilung
With Sterilizing Rack and Compartments
Con Supporto per sterilizzazione e scomparti
Con Cuadro de esterilización y compartimentos
Avec Cadre de stérilisation et compartimentée

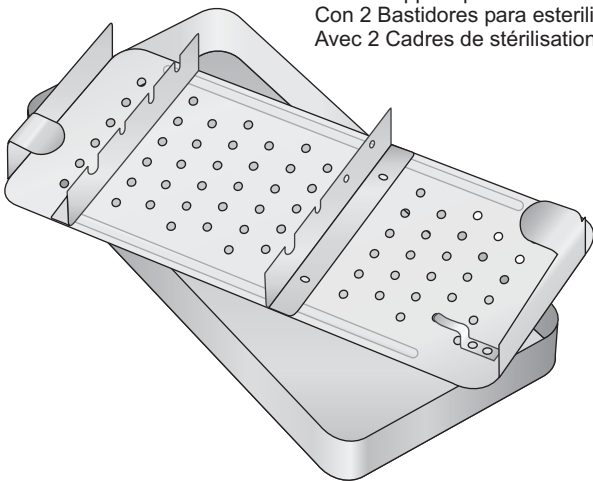

BS-30 180 x 90 x 35 mm

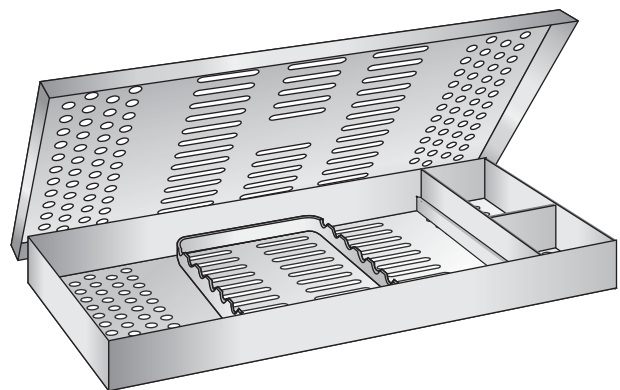

BS-40 275 x 130 x 25 mm
BS-42 285 x 190 x 25 mm

Gefäße aus Edelstahl

Stainless Steel
Receptacles

Recipienti in acciaio
inossidabile

Recipientes de acero
inoxidable

Réceptients en acier
inoxydable

Tray Inox mit Silikoneinrichtung - Stainless Steel Cassettes with Silicone Racks
Tray Inox con griglia in silicone - Recipientes de acero con equipo de silicona
Cassettes en acier avec aménagement en silicone

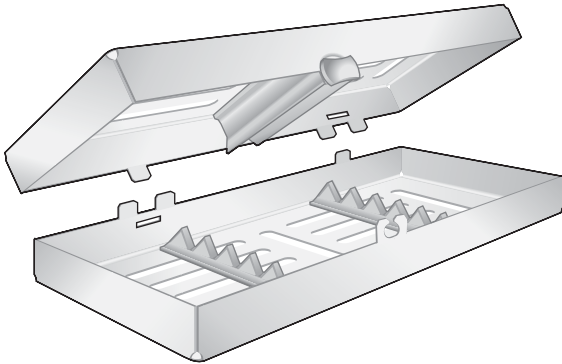

BS-59 Für 5 Instrumente
185 x 75 x 35 mm For 5 Instruments
Per 5 strumenti
Para 5 instrumentos
Pour 5 instruments

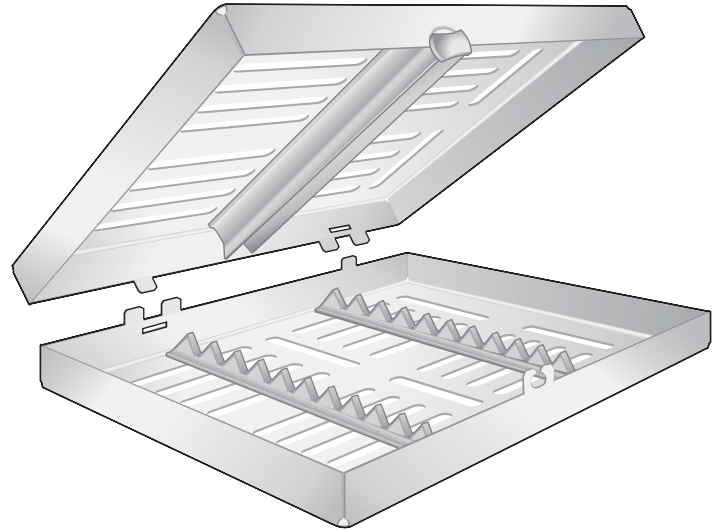

BS-60 Für 10 Instrumente
185 x 135 x 35 mm For 10 Instruments
Per 10 strumenti
Para 10 instrumentos
Pour 10 instruments

BS-61 Für 20 Instrumente
290 x 185 x 35 mm For 20 Instruments
Per 20 strumenti
Para 20 instrumentos
Pour 20 instruments

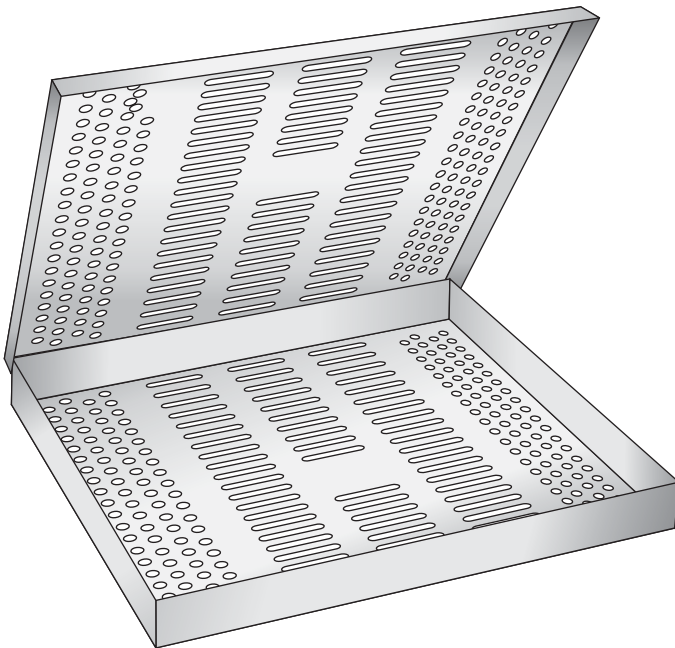

BS-43
285 x 190 x 25 mm

Instrumentenkästen
Instrument Boxes
Cestelli rettangolari
Cajas para instrumentos
Panier rectangulaire

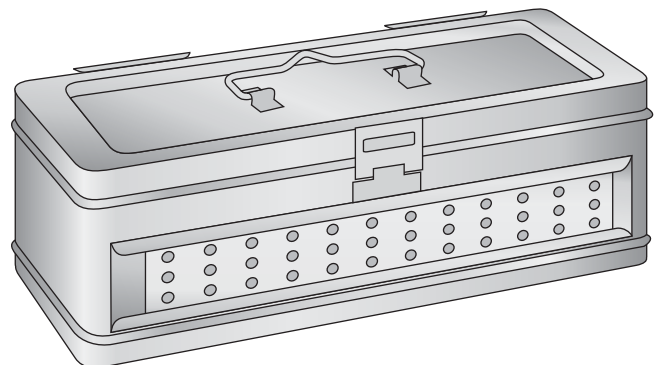

CS-32 300 x 150 x 60 mm
CS-33 300 x 150 x 90 mm
CS-34 300 x 150 x 180 mm

Silikon Noppenmatten

Silicone Mats

Tappeti in aghi di
silicone

Tapete en agujas de
silicona

Tapis en Silicone

Sterilisierbar - Autoclavable
Autoclavabili - Esterilizable
Stérilisable

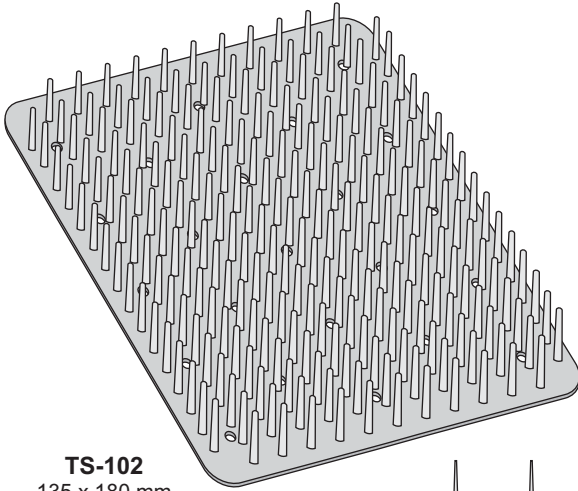

TS-102
135 x 180 mm

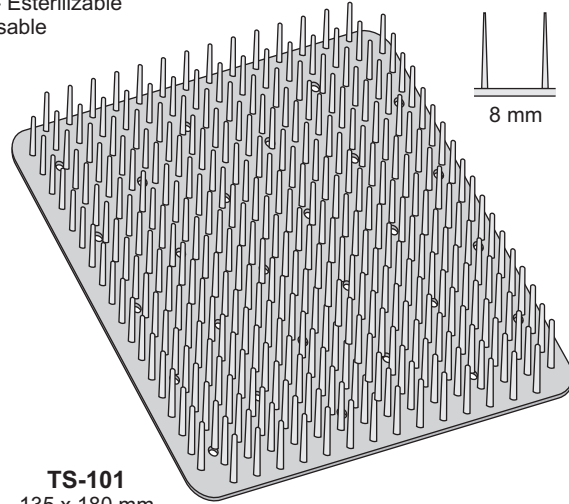
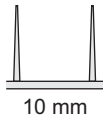

TS-101
135 x 180 mm

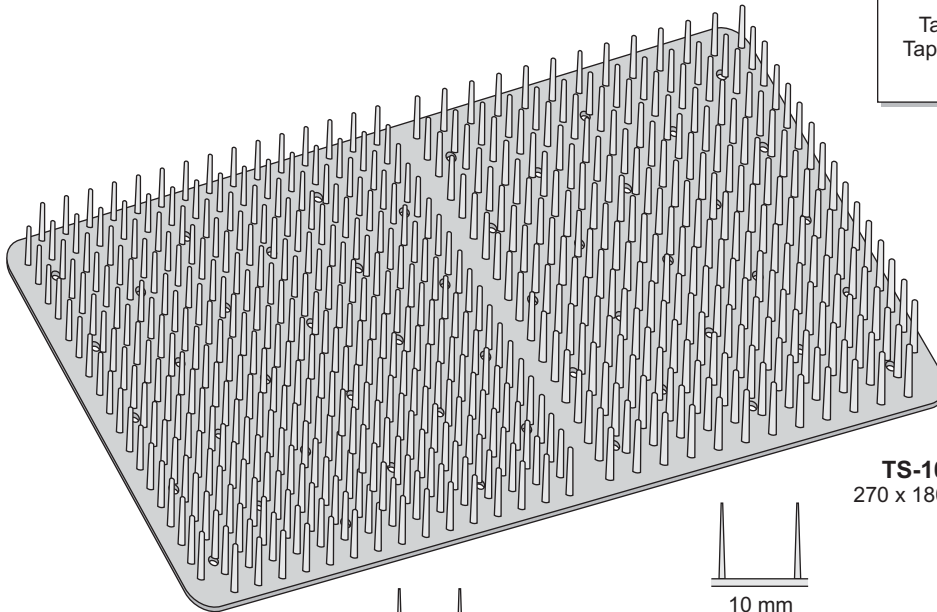
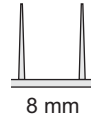

TS-104
270 x 180 mm

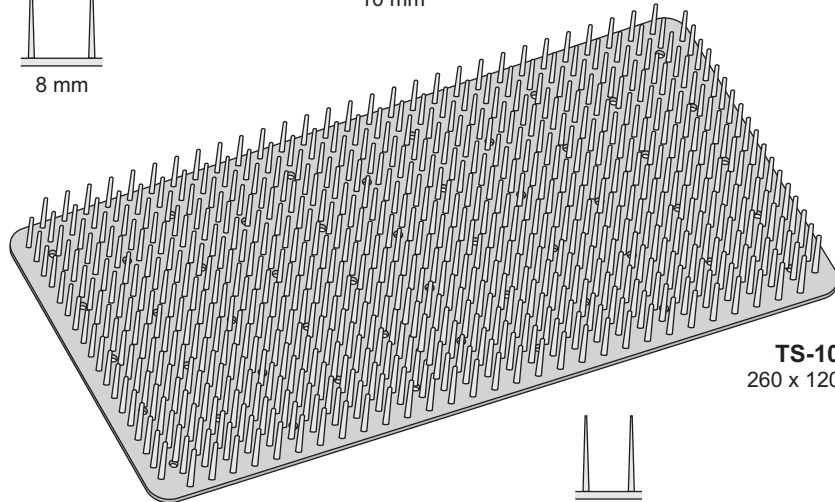
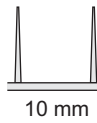

TS-103
260 x 120 mm



Silikon Matten
Matte en silicone
Tappeti in aghi di silicone
Tapete en agujas de silicona
Tapis en Silicone

Sterilisierzangen

Sterilizing forceps

Pinze per sterilizzazione

Pinzas para esterilización

Pinces à stérilisation

Sterilisierzangen zum Fassen und Halten Steriler Instrumente
Sterilizing forceps for picking up and holding of sterile instruments
Pinze per prelevare strumenti sterilizzati
Pinzas para esterilización
Pinces pour saisir les objets stérilisés



GS-02
145 mm

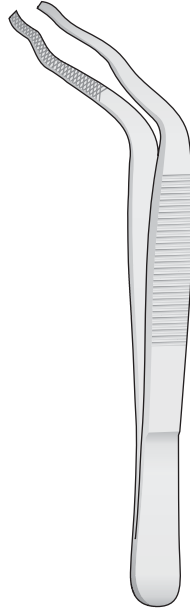

DAVIS GS-03
160 mm



DAVIS GS-04
200 mm

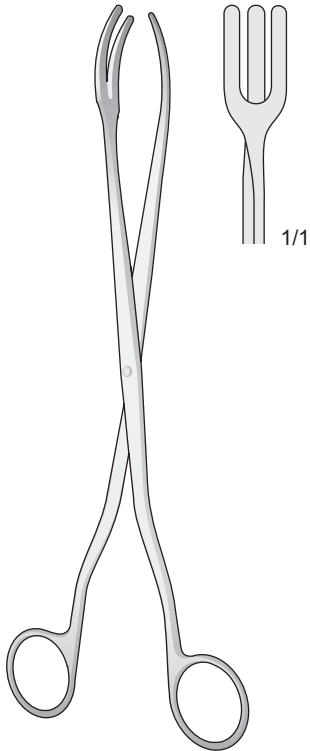

GS-10
200 mm

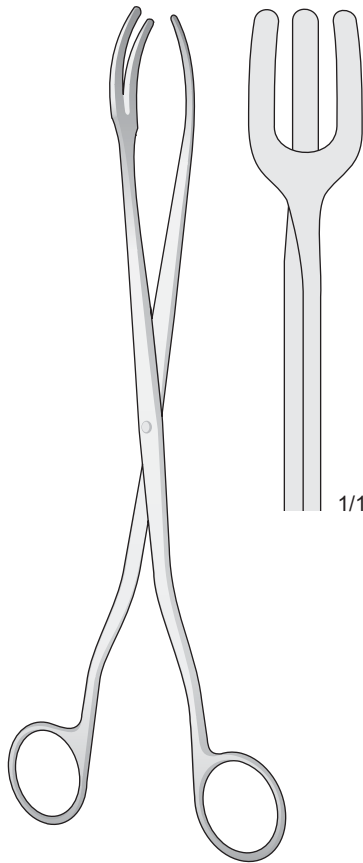

GS-11
300 mm

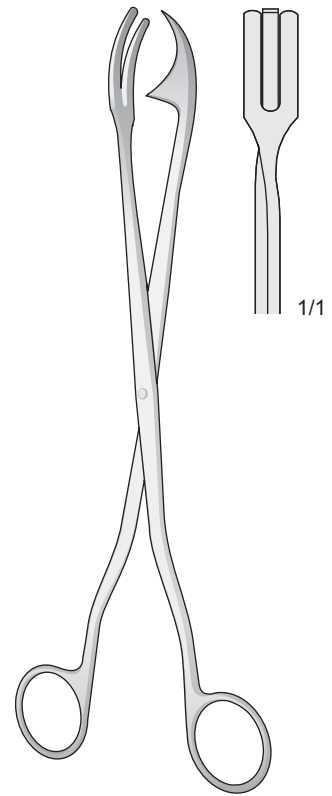

ROGGE GS-06
230 mm

Sterilisierzangen

Sterilizing forceps

Pinze per sterilizzazione

Pinzas para esterilización

Pinces à stérilisation

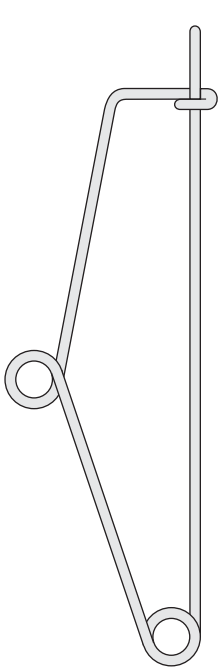

MAYO
GS-01
140 mm

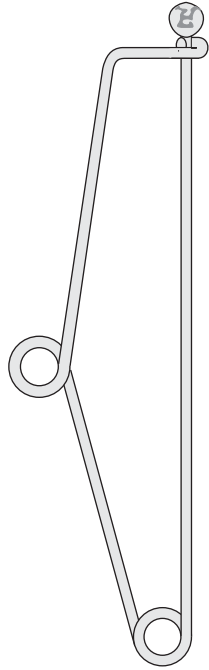

MAYO
GS-07
140 mm

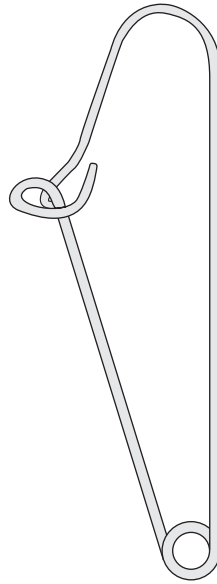

BUNT
GS-09
110 mm

Sterilisierzangen zum Fassen und Halten Steriler Instrumente
Sterilizing forceps for picking up and holding of sterile instruments
Pinze per prelevare strumenti sterilizzati
Pinzas para esterilización
Pinces pour instruments stérilisés

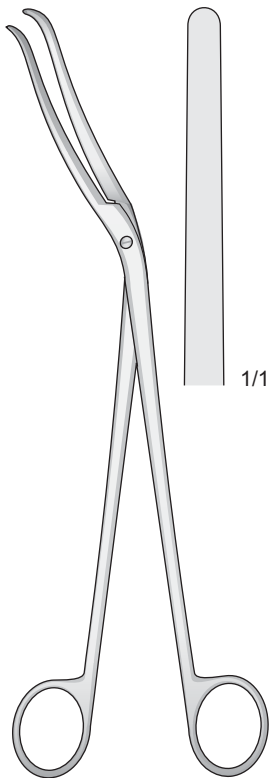

CHEATTLE
GS-05
265 mm

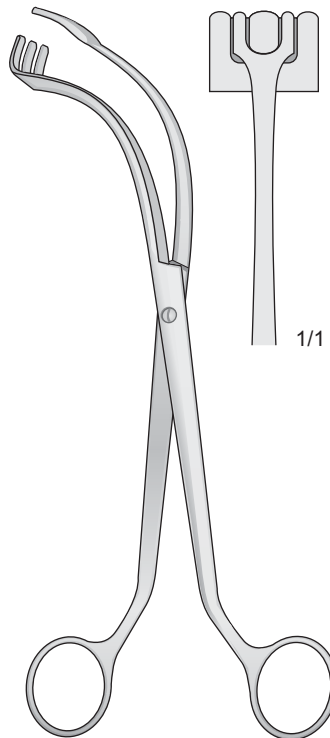

COLLIN
GS-30
250 mm

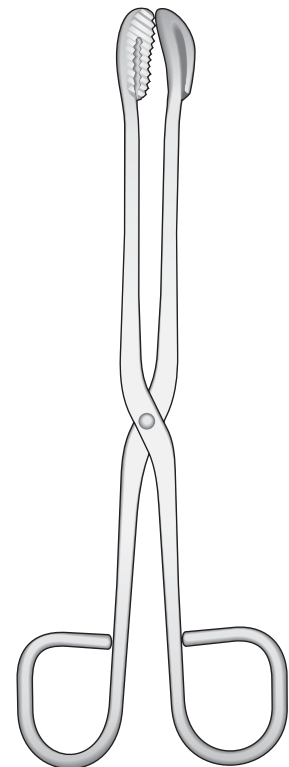

GS-13 200 mm
GS-14 300 mm

A

ADSON , Absaugkanülen	293
- Wundhaken	193
- Raspatorien	218
- Chirurgische Pinzetten	87, 88, 101, 104
ADSON-BROWN , Chirurgische Pinzetten	87, 88
ALDERDYCE , Raspatorien	209
ALLIS , Gewebe Fasszange	110
ALM , Wundspreizer	191
Mundsperrer	165 - 168
ARKANSAS , Schleifesteine	310
ARRUGA , Nadelhalter	154
ASCH , Rhinologie	282
AUFRIECHT , Wundspreizer	170, 197
- Knochenfeilen	257
AUFRIECHT-WALTER , Wundspreizer	170
AUSTIN , Chirurgische Pinzetten	86
AXENFELD , Wundspreizer	176
AYERS , Mikro Pinzetten	99

B

BABBUSH , Elevators	209
BABY-ADSON , Arterienklemmen und Ligaturklemmen	127
BABY-ALLIS , Gewebe Fasszange	110
BABY-CRILE , Arterienklemmen	120
BABY-CRILE-WOOD , Nadelhalter	147
BABY-METZENBAUM , Feine Scheren	34
BABY-MIXTER , Arterienklemmen und Ligaturklemmen	127
BACKHAUS , Tuckklemmen	112
BALLENGER , Osteotome	225
- Skalpelle	12
- Rhinologie	238
BALLENGER-HAYEK , Raspatorien	211
BARON , Absaugkanülen	291
BARRAQUER , Wundhaken	174
- Mikro Nadelhalter	134, 136
- Cilienpinzetten	106
BARTH , Sharfe Löffel	261
BEASLEY-BACOCK , Chirurgische Pinzetten	87
BEAUPRE , Cilienpinzetten	106
BECKMANN , Nasen Spekula	200
BEER , Cilienpinzetten	106
BELLUCCI , Absaugkanülen	291
- Mikro Ohrzängchen	158
BENGOLEA , Arterienklemmen	126
BERGMANN , Chirurgische Hämmer	249
BEYER , Hohlmeißelzange	273
BIEMER , Approximatoren	157
- Gefäß Clips	155
BIEMER-MÜLLER , Approximatoren	157
BIRCHER-GANSKE , Hohlmeißelzange	276
BIRKETT , Arterienklemmen	126
BIRO , Feine Scheren	22
BISHOP-HARMON , Mikro Pinzetten	100
Skalpelle	6 - 12
BLUMENTHAL , Hohlmeißelzange	270
BÖHLER , Hohlmeißelzange	275
BOIES , Rhinologie	283
BONN , Mikro Pinzetten	100
BONNEY , Chirurgische Pinzetten	102
BOYNTON , Nadelhalter	154
BOWMANN , Sonden	160
BRAUN , Arterienklemmen	114
BROCK , Mikro Scheren	17
- Mikro Pinzetten	81
- Mikro Nadelhalter	133
BRÜNINGS , Skalpelle	12
BRUNS , Sharfe Löffel	264
BUCKLEY , Osteotome	224
BUNT , Sterilisierzange	316

C

Absaugkanülen	287 - 302
----------------------	-----------

CAPLAN , Knochensplitterscheren	47
- Rhinologie	283
CARTER , Raspatorien	212
CASPAR , Scalpellgriffe	9
CASTROVIEJO , Mikro Nadelhalter	136, 137
- Nadelhalter	138, 140
- Meßinstrumente	4
CHADWICK , Feine Scheren	22
CHEATTLE , Sterilisierzange	316
CINELLI , Feine Scheren	34
- Rhinologie	233
COLLIN , Sterilisierzange	316
CONVERSE , Skalpelle	11
- Wundspreizer	172
- Knochenfeilen	254
- Nadelhalter	145
CONWAY , Wundspreizer	179
CORN , Chirurgische Pinzetten	86
CORONAL , Wundspreizer	190
COTTLE , Skalpelle	11
- Wundspreizer	172, 175, 177, 179
- Chirurgische Scheren	23, 46, 64
- Knochenfeilen	257
- Chirurgische Hämmer	249
- Mikro Pinzetten	99
- Osteotome	230, 236, 237
- Raspatorien	210, 211, 212
- Rhinologie	201
- Knorpelquetsche	175
COTTLE-KNAPP , Feine Scissors	24
COTTLE-MASING , Feine Scissors	22
COTTLE-NEIVERT , Wundspreizer	175
COTTLE-WALSHAM , Rhinologie	282
CRAIG , Rhinologie	283
CRILE , Arterienklemmen	119, 120
CRILE-MURRAY , Nadelhalter	141
CRILE-WOOD , Nadelhalter	141, 147, 153
Sharfe Löffel	261 - 265
CUSHING , Wundspreizer	178, 181, 182
- Periostotome	218
- Chirurgische Pinzetten	93, 102
CUSHING-KOCHER , Wundspreizer	182

D

DANDY , Arterienklemmen	119
DAVIS , Wundhaken	206
- Sterilisierzange	315
DAVIS-BOYLE , Mundsperrer	166
DEAN , Chirurgische Scheren	45
DEAVER , Chirurgische Scheren	32
- Wundhaken	184
DERF , Nadelhalter	141, 145
DESMARRES , Wundhaken	179
- Wundhaken Isoliert	130
- Mikro Pinzetten	99
DE BAKEY , Atraumatische Pinzetten	96, 97, 98
- Chirurgische Pinzetten	103
- Nadelhalter	150
DE MARTEL , Feine Arterienklemmen	111
DIEFFENBACH , Gefäßclips	155
DIETRICH , Nadelhalter	138
DINGMANN , Mundsperrer	167
- Hohlmeißelzange	276
- Knochenfeilen	256
Dissektoren	205 - 208
Wundhaken	172 - 197
DIXON-LOVELACE , Arterienklemmen	126
DUNN-DAUTREY , Wundhaken	171
DUPLAY , Nasen Spekula	3

E

ELSCHNIG , Chirurgische Pinzetten	100
EPKER , Osteotome	235

F

FACE-LIFT , Chirurgische Scheren	67, 69
- Wellenschliff Scheren	70
FAGER , Dissektoren - Separatores	206
FARABEUF , Wundhaken	180
- Periostotome	219
FARABEUF-COLLIN , Raspatorien	219
FAULKNER , Rhinologie	232
FAURE , Tuchklemmen	112
FEICHENFELD , Splitterpinzetten	106
FERGUSSON , Absaugkanülen	290
FERRIS-SMITH-CUSHING , Knochensplitterscheren	274
FINSEN , Wundhaken	191
FOERSTER-BALLENGER , Tamponzangen	115
FOMON , Skalpelle	11
- Wundhaken	175
- Chirurgische Scheren	45, 46, 64
- Feine Scheren	34
- Knochenfeilen	255, 259
- Periostotome	213
- Rhinologie	233
Scheren	15 - 75
FOSTER-GILLIES , Nadelhalter	144
FOX , Scharfe Löffel	263
FRAZIER , Absaugkanülen	290, 293
FREEMAN , Wundhaken	190
- Chirurgische Scheren	66, 71
- Wellenschliff Scheren	72
FREEMAN-GORNEY , Chirurgische Scheren	66, 71
FREEMAN-KAYE , Chirurgische Scheren	66, 67, 73
FREER , Osteotome	223
- Skalpelle	12
- Mikro Wundhaken	175
- Periostotome	209, 212, 213, 216
FRIEDMANN , Hohlmeißelzangen	270, 271

G

GALLAHER , Knochenfeilen	256
GEMINI , Arterienklemmen	129
GERALD , Chirurgische Pinzetten	95, 104
GERALD-BROWN , Chirurgische Pinzetten	95
GIDEF , Feine Arterienklemmen	118
GIESSEN , Wundhaken	180
GILLIES , Mikro Wundhaken	173
- Atraumatische Pinzetten	98
- Nadelhalter	144, 148
GIUNTA-NASAL , Wellenschliff Scheren	70
GLASSMAN , Chirurgische Scheren	27
GOLDMANN , Rhinologie	283
GOLDMAN-FOX , Chirurgische Scheren	25, 49, 53
- Feine Scheren	25
GOOD , Tonsillenschere	43
GORNEY , Absaugkanülen	289
- Wundhaken	190
- Chirurgische Scheren	43, 73
- Hohlmeißelzange	47
- Wellenschliff Scheren	67, 68, 70, 72
GRAEFE , Feine Scheren	22
- Mikro Pinzetten	99
- Chirurgischen Pinzetten	86, 100
GREEN , Mikro Pinzetten	99
GREENBERG-PAR , Nasal Scheren	48, 54
GREGORY , Chirurgische Scheren	69
GROSS , Tamponzange	115
GRUENWALD , Chirurgische Pinzetten	105
GUILLIEN , Absaugkanülen	289
GUTHRIE , Mikro Wundhaken	173, 174

H

HABERER , Wundhaken	168
HALSEY , Nadelhalter	141, 145
HALSTED , Arterienklemmen	120
- Feine Arterienklemmen	118

HALSTED-MOSQUITO , Arterienklemmen	120
- Feine Arterienklemmen	117
HARRINGTON , Wundhaken	185
HARTMANN , Zungendrucker	169
- Absaugkanülen	294
- Rhinologie	198, 199
- Spekula für Erwachsene	3
HARTMANN-BABY-MOSQUITO , Feine Arterienklemmen	117
HEANEY(HEGAR) , Nadelhalter	142
HEGAR , Nadelhalter	142, 146
HEGAR-MAYO-STILLE , Nadelhalter	153
HEISS , Arterienklemmen	126
HENAHAN , Periostotome	218
HEYMANN , Chirurgische Scheren	46
HEYMANN-KNIGHT , Chirurgische Scheren	45
HOUSE , Absaugkanülen	292
- Wundhaken	178
HOWARD , Knochenfeilen	253
HOWARTH , Periostotome	211
HUNT , Mikro Pinzetten	99
HUNTER , Splitterpinzetten	106

I

IRIS , Chirurgische Scheren	50, 53
- Feine Scheren	20
- Links Scheren	52
- Wellenschliff Scheren	65

J

JACOBSON , Sharfe Löffel	261
- Mikro Scheren	16
- Mikro Nadelhalter	135
- Nadelhalter	139
JACOBSON-MICRO , Feine Arterienklemmen	111
JAEGER , Mikro Wundhaken	174
JAMESON , Chirurgische Scheren	23
JAMESON-WERBER , Chirurgische Scheren	23
JANSEN , Sharfe Löffel	261
- Hohlmeißelzange	272
- Chirurgische Pinzetten	105
- Raspatorien	219
JONES , Tuchklemmen	112, 114
JOSEPH , Skalpelle	11, 12
- Wundhaken	175
- Chirurgische Scheren	33, 64
- Knochenfeilen	256
- Periostotome	212, 213, 218
- Rhinologie	258

K

KAHN , Chirurgische Scheren	44
KAYE , Feine Scheren	19
KAYE-FACE-LIFT , Chirurgische Scheren	71
KELLY , Chirurgische Scheren	28, 54
- Arterienklemmen	123
KERPEL , Sharfe Löffel	263
KERSCHNER , Mikro Wundhaken	173
KEYES , Rhinologie	263
KILLIAN , Osteotome	225
- Absaugkanülen	295
- Periostotome	211
- Rhinologie	198, 199, 283
KILLIAN-KLAUS , Osteotome	225
KILNER , Wundhaken	172
- Chirurgische Scheren	23, 27, 48, 54
- Wellenschliff Scheren	70
KILNER-DOUGHTY , Mundsperrer	165
KIRBY , Wundhaken	175, 179
KLAR-EVATEUR , Wundhaken	179
KLEINERT-KUTZ , Hohlmeißelzange	273
KNAPP , Mikro Wundhaken	174
KOCHER , Wundhaken	182
- Arterienklemmen	121, 123, 125

Alphabetisches Inhaltsverzeichnis	Alphabetical index	Indice alfabetico	Indice alfabetico	Index alphabétiques
KOCHER-OCHSNER , Arterienklemmen		122	MILLER , Knochenfeilen	253
KÖNIG , Elevatorien		205	MILLIGAN , Dissektorien - Separatoren	206
KRESSNER , Rhinologie		282	MINI-FRIEDMANN , Hohlmeißelzange	269, 270
KUHNT , Chirurgische Pinzetten		100	MINI-GILLIES , Nadelhalter	144, 148
L			MINI-LAMBOTTE , Osteotome	229
LA GRANGE , Feine Scheren	25, 49		MINI-LEXER , Osteotome	244
LAMBERT , Mikro Pinzetten	99		MINI-MALTZ , Knochenfeilen	259
LAMBOTTE , Periostotome - Raspatorien	242		MINI-OLSEN-HEGAR , Nadelhalter	143
LANGENBECK , Periostotome	209, 219		MINI-ROUX , Wundhaken	181
Laryngoskope	3		MOD. MARTIN , Watterträger	161
LEMPERT , Hohlmeißelzange	271		MODELL WIEN , Nasen Spekula	200
LERICHE , Arterienklemmen	119		MOLT , Mundsperrerr	218
LEXER , Osteotome	245		MÜLLER , Approximatoren	157
- Chirurgische Scheren	41, 62		N	
LEWIS , Knochenfeilen	257		NEIVERT , Wundhaken	177
LICHTENBERG , Nadelhalter	154		NELSON-METZENBAUM , Chirurgische Scheren	37
LIEBERMANN-TENNANT , Mikro Wundhaken	173		NEWS , Wundhaken	178
Knochenfeilen	253 - 260		NOYES , Mikro Scheren	15
LISTER , Arterienklemmen	114		NUBOER , Absaugkanülen	288
LISTON , Hohlmeißelzange	275		O	
LITTAUER , Cilienpinzetten	106		OBWEGESER , Ligaturnadel	159
LITTLER , Feine Scheren	34		- Wundhaken	170, 183
LOCKLIN , Chirurgische Scheren	24, 28		- Osteotome	247
LOCKLIN MOD. , Chirurgische Scheren	24		- Periostotome	215, 217
LOGAN , Wundhaken	191		O'BRIEN , Ligatur Scheren	74
LORNA , Tuchklemmen	113		O'CONNOR , Mikro Wundhaken	174
LOVE , Wundhaken	178		OLIVECRONA , Dissektorien	207
LUCAE , Chirurgische Hämmer	248		- Hohlmeißelzange	272
- Chirurgische Pinzetten	105		OLSEN-HEGAR , Nadelhalter	143, 149
LUENEBURG , Elevatorien	205		OMBREDANNE , Chirurgische Hämmer	249
LUER , Wundhaken	178		Osteotome	223 - 248
- Hohlmeißelzange	272		ORINGER , Mundsperrerr	169
M			OVERHOLT , Arterienklemmen	128
MacCOLLUM-DINGMAN , Dissektorien	189		OVERHOLT-GEISSENDORFER , Arterienklemmen	128
MAGILL , Absaugkanülen	295		P	
MAIER , Tamponzange	116		PARKER-LANGENBECK , Wundhaken	180
MALINIAC , Wundhaken	197		PAR-TYPE , Chirurgische Scheren	54
MALTZ , Skalpelle	12		PARTSCH , Osteotome - Hohlmeißel	227, 228
- Knochenfeilen	259		PAPAVERO-HARTMANN , Rhinologie	201
- Rhinologie	260		PAUL , Wundhaken	176
MARTINI , Sharfe Löffel	261		PEAN , Arterienklemmen	121, 124
Chirurgische Hämmer	249 - 250		- Feine Arterienklemmen	118
MASING , Skalpelle	12		PEAN-MURPHY , Arterienklemmen	114
- Periostotome	210, 212		PECK-JOSEPH , Chirurgische Scheren	53
- Rhinologie	233		PEET , Feine Arterienklemmen	111
MATHIEU , Nadelhalter	154		PENFIELD , Wundhaken	208
MAYO , Chirurgische Scheren	39, 40, 51, 63		PENNINGTON , Periostotome	211
- Sterilisierzange	316		Periostotome	209 - 219
MAYO-HEGAR , Nadelhalter	142, 146		PERRY , Chirurgische Pinzetten	85
MAYO-HEGAR-FINO , Nadelhalter	147		PIERCE , Periostotome	211
MAYO-HEGAR-HEANEY , Nadelhalter	146		Arterienklemmen	109 - 130
MAYO-LEXER , Chirurgische Scheren	63		Pinzetten	79 - 106
MAYO-NOBLE , Chirurgische Scheren	39		PITANGUI , Markator	109
MAYO-STILLE , Chirurgische Scheren	42, 62		PLESTER , Absaugkanülen	290
MC DONALD , Periostotome	216		- Wundhaken	194
MC INDOE , Rhinologie	232		Nadelhalter	133 - 154
- Atraumatische Pinzetten	98		POTTS-SMITH , Chirurgische Pinzetten	92, 102
MC INTOSH , Set Laryngoskope	3		POTTS-YASARGIL , Mikro Scheren	16
MC IVOR , Mundsperrerr	166		Q	
MC KENTY , Periostotome	211, 213		QUINBY , Feine Scheren	22
MC PHERSON , Chirurgische Pinzetten	100		QUINKE , Nadel für Biopsie	303
MEAD , Chirurgische Hämmer	248		R	
- Periostotome	209		RADOLF , Handchirurgie	280
- Hohlmeißelzange	270		RAGNELL , Wundhaken	180
MEDHORN , Gefäßclips	155		R	
METZENBAUM , Chirurgische Scheren	33, 35, 36, 48, 50, 58		QUINBY , Feine Scheren	22
- Wellenschliff Scheren	65		QUINKE , Nadel für Biopsie	303
METZENBAUM-FINO , Chirurgische Scheren	35, 36, 53, 59, 60, 61		R	
MICRO-HALSTED , Feine Arterienklemmen	117		RADOLF , Handchirurgie	280
MICRO-IRIS , Feine Scheren	20		RAGNELL , Wundhaken	180
MICRO-RYDER , Nadelhalter	151, 152		R	
MICRO-VASCULAR , Nadelhalter	150		RADOLF , Handchirurgie	280
MILLARD , Wundhaken	172, 190		RAGNELL , Wundhaken	180

- Mikro Feine Scheren	19
RAGNELL-DAVIS , Wundhaken	180
RAMPLEY , Tamponzange	116
RANKIN , Arterienklemmen	123
REYNOLDS , Feine Scheren	26
Rhinologie	198 - 201
ROCHESTER-PEAN , Arterienklemmen	122, 129
ROGER , Periostotome	211
ROGGE , Sterilisierzange	315
ROLLET , Mikro Wundhaken	174
ROWE , Knochen Chirurgie	281
ROSE , Wundhaken	178
ROSTKOWSKI , Wundhaken	179
ROUX , Wundhaken	181
ROUX-MAGNUS , Wundhaken	181
RUBIN , Rhinologie	234, 282
RUSKIN , Hohlmeißelzange	273
RUSKIN-LISTON , Hohlmeißelzange	275
RUSKIN-STILLE , Hohlmeißelzange	273
RYDER , Nadelhalter	152

S

SAALFELD , Sharfe Löffel	262
SACHS , Dissektoren - Separatoren	206
SALZBURG , Periostotome	210
SAROT , Nadelhalter	149
SAUG-RASPATORIUM , Absaugkanülen	289
SCHAEDEL , Tuchklemmen	112
SCHEDE , Sharfe Löffel	264
SCHNEIDER , Periostotome	219
SCHNEIDER-SAUERBRUCH , Periostotome - Raspatorien	242
SCHWECKENDIEK , Tonsillenscheren	43
SCOVILLE , Wundhaken	182
SEDILLOT , Periostotome	214, 219
SEMKEN , Chirurgische Pinzetten	87, 92, 101
SENN-GREEN , Wundhaken	180
SENN-MILLER , Wundhaken	177
SEWALL , Periostotome	212
SHEA , Chirurgische Scheren	33
SHEEHAN , Osteotome	226
SILVER , Rhinologie	232
SIMON , Wundhaken	184
SPENCER , Ligaturschere	74
STACKE , Sonden	160
STEINHÄUSER , Periostotome	217
STELLA , Chirurgische Scheren	68
STELLBRINK , Hohlmeißelzange	269, 271
STEVENS , Feine Scheren	19, 26, 48
STILLE , Chirurgische Scheren	42
- Anatomische Pinzetten	90
STITCH , Feine Scheren	19
Meßinstrumente	4 - 5
SWEDESH MOD. , Nadelhalter	149

T

TAKAHASHI , Hohlmeißelzange	274
TAYLOR , Chirurgische Pinzetten	102
TENNANT , Chirurgische Pinzetten	100
TESSIER , Osteotome	239, 241
THOREK , Chirurgische Scheren	38
TIECK-HALLE , Nasen Spekula	200
TOBOLD , Zungendrucker	169
TOENNIS , Chirurgische Scheren	38
TOENNIS-ADSON , Chirurgische Scheren	38, 64
TROELTSCH , Chirurgische Pinzetten	105
TUFFIER , Wundhaken	168
TUOHY , Biopsie Kanülen	303

U

UNIVERSAL , Watterträger	161
UNNA , Sharfe Löffel	262

V

VANNAS , Mikro Scheren	15
VARADY , Haken Stripper	195
VERESS , Biopsie Nadel	303
VIDAL , Sharfe Löffel	263
WISE , Mikro Pinzetten	79
VOLKMANN , Sharfe Löffel	262, 265

W

WALTER , Osteotome	231
WALTON , Feine Scheren	19, 34
- Periostotome	213
WANGENSTEEN , Chirurgische Pinzetten	102
WARWICK-JAMES , Eckenzangen	306
WEBSTER , Nadelhalter	145
WEIL-BLAKESLEY , Hohlmeißelzange	274
WEITLANER , Wundhaken	192, 193
WERTHEIMER , Absaugkanülen	293
WEST , Osteotome - Hohlmeißel	228
WESTCOTT , Mikro Scheren	15
WHITEHEAD-JENNINGS , Mundsperrer	165
WIEDER , Zungencrücker	169
WIENER , Mikro Wundhaken	174
WILLIGER , Sharfe Löffel	261, 265
- Elevatoren	205
- Chirurgische Hämmer	248
WILMER , Feine Scheren	22
WULLSTEIN , Wundhaken	192
- Mikro Ohrzängchen	158

Y

YANCOSKIE , Wundhaken	190
YANKAUER , Dissektoren	206
- Drahtumführungsnadel	159
YASARGIL , Mikro Scheren	16

Z

ZAUFAL-JANSEN , Hohlmeißelzangen	273
---	-----

A

ADSON , Suctions tubes	293
- Retractor	193
- Periosteal	218
- Tissue Forceps	87, 88, 101, 104
ADSON-BROWN , Tissue Forceps	87, 88
ALDERDYCE , Periosteal	209
ALLIS , Gum and Tissue Forceps	110
ALM , Retractors	191
Mouth Gags	165 - 168
ARKANSAS , Accessories for re-sharpening	310
ARRUGA , Needle holders	154
ASCH , Rhinology	282
AUFRIEHT , Retractors	170, 197
- Bone files	257
AUFRIEHT-WALTER , Retractors	170
AUSTIN , Tissue Forceps	86
AXENFELD , Retractors	176
AYERS , Delicate Forceps	99

B

BABBUSH , Periosteal	209
BABY-ADSON , Hemostatic Forceps and Ligature	127
BABY-ALLIS , Gum and Tissue Forceps	110
BABY-CRILE , Hemostatic Forceps	120
BABY-CRILE-WOOD , Needle Holders	147
BABY-METZENBAUM , Delicate Scissors	34
BABY-MIXTER , Hemostatic Forceps and Ligature	127
BACKHAUS , Towel Clamps	112
BALLENGER , Osteotome	225
- Knives	12
- Rhinology	238
BALLENGER-HAYEK , Periosteal	211
BARON , Suction Tubes	291
BARRAQUER , Retractors	174
- Micro Needle Holders	134, 136
- Cilia Forceps	106
BARTH , Curettes	261
BEASLEY-BACOCK , Tissue Forceps	87
BEAUPRE , Cilia Forceps	106
BECKMANN , Nasal Specula	200
BEER , Cilia Forceps	106
BELLUCCI , Suction Tubes	291
- Micro Ear forceps	158
BENGOLEA , Hemostatic Forceps	126
BERGMANN , Surgical Mallets	249
BEYER , Bone cutting Forceps	273
BIEMER , Approssimator	157
- Vascular Clamps	155
BIEMER-MÜLLER , Approssimator	157
BIRCHER-GANSKE , Bone surgery	276
BIRKETT , Hemostatic Forceps	126
BIRO , Delicate Scissors	22
BISHOP-HARMON , Micro forceps	100
Knives	6 - 12
BLUMENTHAL , Bone cutting Forceps	270
BÖHLER , Bone cutting Forceps	275
BOIES , Rhinology	283
BONN , Micro Forceps	100
BONNEY , Tissue Forceps	102
BOYNTON , Needle Holders	154
BOWMANN , Probes	160
BRAUN , Hemostatic Forceps	114
BROCK , Micro Scissors	17
- Micro Forceps	81
- Micro Needle Holders	133
BRÜNINGS , Scalpel	12
BRUNS , Curettes	264
BUCKLEY , Osteotome	224
BUNT , Sterilizing Instruments	316

C

Suction tubes	287 - 302
----------------------	-----------

CAPLAN , Bone Cutting Scissors	47
- Rhinology	283
CARTER , Periosteal	212
CASPAR , Scalpel handles	9
CASTROVIEJO , Micro Needle Holders	136, 137
- Needle Holders	138, 140
- Measuring Instruments	4
CHADWICK , Delicate Scissors	22
CHEATTLE , Sterilizing Instruments	316
CINELLI , Delicate Scissors	34
- Rhinology	233
COLLIN , Sterilizing Instruments	316
CONVERSE , Scalpel	11
- Retractors	172
- Bone Files	254
- Needle Holders	145
CONWAY , Retractors	179
CORN , Tissue Forceps	86
CORONAL , Retractor	190
COTTLE , Knives	11
- Retractors	172, 175, 177, 179
- Tissue Forceps	23, 46, 64
- Bone files	257
- Surgical Mallets	249
- Micro Forceps	99
- Osteotome	230, 236, 237
- Periosteal	210, 211, 212
- Rhinology	201
- Bone crusher	175
COTTLE-KNAPP , Delicate Scissors	24
COTTLE-MASING , Delicate Scissors	22
COTTLE-NEIVERT , Retractors	175
COTTLE-WALSHAM , Rhinology	282
CRAIG , Rhinology	283
CRILE , Hemostatic Forceps	119, 120
CRILE-MURRAY , Micro Needle Holders	141
CRILE-WOOD , Needle Holders	141, 147, 153
Curettes	261 - 265
CUSHING , Retractors	178, 181, 182
- Periosteal	218
- Tissue Forceps	93, 102
CUSHING-KOCHER , Retractors	182

D

DANDY , Operating Scissors	119
DAVIS , Retractors	206
- Sterilizing Instruments	315
DAVIS-BOYLE , Mouth gags	166
DEAN , Serrated Scissors	45
DEAVER , Operating Scissors	32
- Retractors	184
DERF , Needle Holders	141, 145
DESMARRES , Retractors	179
- Isolated Retractor	130
- Micro Forceps	99
DE BAKEY , Atraumatic Forceps	96, 97, 98
- Tissue Forceps	103
- Needle Holders	150
DE MARTEL , Delicate Hemostatic Forceps	111
DIEFFENBACH , Clamps	155
DIETRICH , Needle Holders	138
DINGMANN , Mouth gags	167
- Bone surgery	276
- Bone files	256
Dissector	205 - 208
Retractors	172 - 197
DIXON-LOVELACE , Hemostatic Forceps	126
DOCKHORN , Retractors	171
DUPLAY , Nasal specula	3

E

ELSCHNIG , Tissue Forceps	100
EPKER , Osteotome	235

F

FACE-LIFT , Operating Scissors	67, 69
- Wellenschliff Scissors	70
FAGER , Retractors	206
FARABEUF , Retractors	180
- Periosteal	219
FARABEUF-COLLIN , Raspatories	219
FAULKNER , Rhinology	232
FAURE , Towel Clamps	112
FEICHENFELD , Splinter Forceps	106
FERGUSSON , Suction Tubes	290
FERRIS-SMITH-CUSHING , Bone cutting Forceps	274
FINSEN , Retractors	191
FOERSTER-BALLENGER , Sponge and Dressing Forceps	115
FOMON , Scalpel	11
- Retractors	175
- Operating Scissors	45, 46, 64
- Delicate Scissors	34
- Bone files	255, 259
- Periosteal	213
- Rhinology	233
Scissors	15 - 75
FOSTER-GILLIES , Needle Holders	144
FOX , Curettes	263
FRAZIER , Suction Tubes	290, 293
FREEMAN , Retractors	190
- Operating Scissors	66, 71
- Wellenschliff Scissors	72
FREEMAN-GORNEY , Operating Scissors	66, 71
FREEMAN-KAYE , Operating Scissors	66, 67, 73
FREER , Osteotome	223
- Knives	12
- Micro Retractors	175
- Periosteal	209, 212, 213, 216
FRIEDMANN , Bone cutting Forceps	270, 271

G

GALLAHER , Bone files	256
GEMINI , Hemostatic Forceps	129
GERALD , Tissue Forceps	95, 104
GERALD-BROWN , Tissue Forceps	95
GIDEF , Delicate Hemostatic Forceps	118
GIESSEN , Retractors	180
GILLIES , Micro Retractors	173
- Atraumatic Forceps	98
- Needle Holders	144, 148
GIUNTA-NASAL , Wellenschliff Scissors	70
GLASSMAN , Operating Scissors	27
GOLDMANN , Rhinology	283
GOLDMAN-FOX , Operating Scissors	25, 49, 53
- Delicate Scissors	25
GOOD , Tonsil Scissors	43
GORNEY , Suction Tubes	289
- Retractor	190
- Operating Scissors	43, 73
- Bone Cutting Scissors	47
- Wellenschliff Scissors	67, 68, 70, 72
GRAEFE , Delicate Scissors	22
- Micro Forceps	99
- Tissue Forceps	86, 100
GREEN , Micro Forceps	99
GREENBERG-PAR , Nasal Scissors	48, 54
GREGORY , Operating Scissors	69
GROSS , Hemostatic Forceps	115
GRUENWALD , Ear Forceps	105
GULLIEN , Suction Tubes	289
GUTHRIE , Micro Retractors	173, 174

H

HABERER , Retractors	168
HALSEY , Needle Holders	141, 145
HALSTED , Hemostatic Forceps	120
- Delicate Hemostatic Forceps	118

HALSTED-MOSQUITO , Hemostatic Forceps	120
- Delicate Hemostatic Forceps	117
HARRINGTON , Retractors	185
HARTMANN , Tongue Forceps	169
- Suction Tubes	294
- Rhinology	198, 199
- Adult Specula	3
HARTMANN-BABY-MOSQUITO , Delicate Hemostatic Forceps	117
HEANEY(HEGAR) , Needle Holders	142
HEGAR , Needle Holders	142, 146
HEGAR-MAYO-SEELEY , Needle Holders	153
HEISS , Hemostatic Forceps	126
HENAHAN , Periosteal	218
HEYMANN , Operating Scissors	46
HEYMANN-KNIGHT , Operating Scissors	45
HOUSE , Suction Tubes	292
- Retractor	178
HOWARD , Bone files	253
HOWART , Periosteal	211
HUNT , Micro Forceps	99
HUNTER , Splinter Forceps	106

I

IRIS , Operating Scissors	50, 53
- Delicate Scissors	20
- Left Scissors	52
- Wellenschliff Scissors	65

J

JACOBSON , Curettes	261
- Micro Scissors	16
- Micro Needle Holders	135
- Needle Holders	139
JACOBSON-MICRO , Delicate Hemostatic Forceps	111
JAEGER , Micro Retractors	174
JAMESON , Operating Scissors	23
JAMESON-WERBER , Operating Scissors	23
JANSEN , Curettes	261
- Bone cutting Forceps	272
- Tissue Forceps	105
- Raspatories	219
JONES , Towel Clamps	112, 114
JOSEPH , Knives	11, 12
- Retractors	175
- Operating Scissors	33, 64
- Bone files	256
- Periosteal	212, 213, 218
- Rhinology	258

K

KAHN , Operating Scissors	44
KAYE , Delicate Scissors	19
KAYE-FACE-LIFT , Operating Scissors	71
KELLY , Operating Scissors	28, 54
- Hemostatic Forceps	123
KERPEL , Curettes	263
KERSCHNER , Micro Retractors	173
KEYES , Rhinology	263
KILLIAN , Osteotome	225
- Suction Tubes	295
- Periosteal	211
- Rhinology	198, 199, 283
KILLIAN-KLAUS , Osteotome	225
KILNER , Retractors	172
- Operating Scissors	23, 27, 48, 54
- Wellenschliff Scissors	70
KILNER-DOUGHTY , Mouth gags	165
KIRBY , Retractors	175, 179
KLAR-EVATEUR , Retractors	179
KLEINERT-KUTZ , Bone cutting Forceps	273
KNAPP , Micro Retractors	174
KOCHER , Retractors	182
- Hemostatic Forceps	121, 123, 125

Alphabetisches Inhaltsverzeichnis	Alphabetical index	Indice alfabetico	Indice alfabetico	Index alphabétiques
KOCHER-OCHSNER , Hemostatic Forceps		122	MILLER , Bone files	253
KÖNIG , Elevator		205	MILLIGAN , Retractors	206
KRESSNER , Rhinology		282	MINI-FRIEDMANN , Bone cutting Forceps	269, 270
KUHNT , Tissue Forceps		100	MINI-GILLIES , Needle Holders	144, 148
L			MINI-LAMBOTTE , Osteotome	229
LA GRANGE , Delicate Scissors	25, 49		MINI-LEXER , Osteotome	244
LAMBERT , Micro Forceps	99		MINI-MALTZ , Bone Files	259
LAMBOTTE , Periosteal - Raspatories	242		MINI-OLSEN-HEGAR , Needle Holders	143
LANGENBECK , Periosteal	209, 219		MINI-ROUX , Retractors	181
Laryngoscopes	3		MOD. MARTIN , Cotton Applicators	161
LEMPERT , Bone cutting Forceps	271		MODELL WIEN , Nasal Specula	200
LERICHE , Hemostatic Forceps	119		MOLT , Periosteal	218
LEXER , Osteotome	245		MÜLLER , Approssimator	157
- Operating Scissors	41, 62		N	
LEWIS , Bone files	257		NEIVERT , Retractors	177
LICHTENBERG , Needle Holders	154		NELSON-METZENBAUM , Operating Scissors	37
LIEBERMANN-TENNANT , Micro Retractors	173		NEWS , Retractor	178
Bone files	253 - 260		NOYES , Micro Scissors	15
LISTER , Hemostatic Forceps	114		NUBOER , Suction Tubes	288
LISTON , Bone cutting Forceps	275		O	
LITTAUER , Cilia Forceps	106		OBWEGESER , Ligature Needle	159
LITTLER , Delicate Scissors	34		- Retractors	170, 183
LOCKLIN , Operating Scissors	24, 28		- Osteotome	247
LOCKLIN MOD. , Operating Scissors	24		- Periosteal	215, 217
LOGAN , Retractors	191		O'BRIEN , Suturing Scissors	74
LORNA , Towel clamps	113		O'CONNOR , Micro Retractors	174
LOVE , Retractors	178		OLIVECRONA , Dissectors	207
LUCAE , Surgical Mallets	248		- Bone cutting Forceps	272
- Tissue Forceps	105		OLSEN-HEGAR , Needle Holder	143, 149
LUENEBURG , Elevator	205		OMBREDANNE , Surgical Mallets	249
LUER , Bone cutting Forceps	178		Osteotome	223 - 248
- Bone Cutting Forceps	272		ORINGER , Mouth gags	169
M			OVERHOLT , Hemostatic Forceps	128
MacCOLLUM-DINGMAN , Dissector	189		OVERHOLT-GEISSENDORFER , Hemostatic Forceps	128
MAGILL , Suction Tubes	295		P	
MAIER , Towel Clamps	116		PARKER-LANGENBECK , Retractors	180
MALINIAC , Nasal Retractor	197		PAR-TYPE , Nasal Scissors	54
MALTZ , Knives	12		PARTSCH , Osteotome - Gouges	227, 228
- Bone Files	259		PAPAVERO-HARTMANN , Rhinology	201
- Rhinology	260		PAUL , Retractors	176
MARTINI , Curettes	261		PEAN , Hemostatic Forceps	121, 124
Surgical Mallets	249 - 250		- Delicate Hemostatic Forceps	118
MASING , Knives	12		PEAN-MURPHY , Hemostatic Forceps	114
- Periosteal	210, 212		PECK-JOSEPH , Operating Scissors	53
- Rhinology	233		PEET , Delicate Hemostatic Forceps	111
MATHIEU , Needle Holders	154		PENFIELD , Retractors	208
MAYO , Operating Scissors	39, 40, 51, 63		PENNINGTON , Periosteal	211
- Sterilizing Instruments	316		Periosteal	209 - 219
MAYO-HEGAR , Needle Holders	142, 146		PERRY , Tissue Forceps	85
MAYO-HEGAR-FINO , Needle Holders	147		PIERCE , Periosteal	211
MAYO-HEGAR-HEANEY , Needle Holders	146		Emostatic Forceps	109 - 130
MAYO-LEXER , Operating Scissors	63		Forceps	79 - 106
MAYO-NOBLE , Operating Scissors	39		PITANGUI , Marker	109
MAYO-STILLE , Operating Scissors	42, 62		PLESTER , Suction Tubes	290
MC DONALD , Periosteal	216		- Retractors	194
MC INDOE , Rhinology	232		Needle Holders	133 - 154
- Atraumatic Forceps	98		POTTS-SMITH , Tissue Forceps	92, 102
MC INTOSH , Set Laryngoscopes	3		POTTS-YASARGIL , Micro Scissors	16
MC IVOR , Mouth gags	166		Q	
MC KENTY , Periosteal	211, 213		QUINBY , Delicate Scissors	22
MC PHERSON , Tissue Forceps	100		QUINKE , Biopsy Needle	303
MEAD , Surgical Mallets	248		R	
- Periosteal	209		RADOLF , Nail Extracting Forceps	280
- Bone cutting Forceps	270		RAGNELL , Retractors	180
MEDHORN , Vascular Clamps	155			
METZENBAUM , Operating Scissors	33, 35, 36, 48, 50, 58			
- Wellenschliff Scissors	65			
METZENBAUM-FINO , Operating Scissors	35, 36, 53, 59, 60, 61			
MICRO-HALSTED , Delicate Hemostatic Forceps	117			
MICRO-IRIS , Delicate Scissors	20			
MICRO-RYDER , Needle Holders	151, 152			
MICRO-VASCULAR , Needle Holders	150			
MILLARD , Retractors	172, 190			

- Micro Delicate Scissors	19
RAGNELL-DAVIS , Retractors	180
RAMPLEY , Sponge and Dressing Forceps	116
RANKIN , Hemostatic Forceps	123
REYNOLDS , Delicate Scissors	26
Rhinology	198 - 201
ROCHESTER-PEAN , Hemostatic Forceps	122, 129
ROGER , Periosteal	211
ROGGE , Sterilizing Instruments	315
ROLLET , Micro Retractors	174
ROWE , Bone surgery	281
ROSE , Retractor	178
ROSTKOWSKI , Retractors	179
ROUX , Retractors	181
ROUX-MAGNUS , Retractors	181
RUBIN , Rhinology	234, 282
RUSKIN , Bone cutting Forceps	273
RUSKIN-LISTON , Bone cutting Forceps	275
RUSKIN-STILLE , Bone cutting Forceps	273
RYDER , Needle Holders	152

S

SAALFELD , Curettes	262
SACHS , Dissectors	206
SALZBURG , Periosteal	210
SAROT , Needle Holders	149
SAUG-RASPATORIUM , Suction Tubes	289
SCHAEDEL , Towel clamps	112
SCHUDE , Curettes	264
SCHNEIDER , Periosteal	219
SCHNEIDER-SAUERBRUCH , Periosteal - Raspatories	242
SCHWACKENDIEK , Tonsil Scissors	43
SCOVILLE , Retractors	182
SEDILLOT , Periosteal	214, 219
SEMKEN , Tissue Forceps	87, 92, 101
SENN-GREEN , Retractors	180
SENN-MILLER , Retractors	177
SEWALL , Periosteal	212
SHEA , Operating Scissors	33
SHEEHAN , Osteotomes	226
SILVER , Rhinology	232
SIMON , Retractors	184
SPENCER , Ligature Scissors	74
STACKE , Probes	160
STEINHÄUSER , Periosteal	217
STELLA , Operating Scissors	68
STELLBRINK , Bone cutting Forceps	269, 271
STEVENS , Delicate Scissors	19, 26, 48
STILLE , Operating Scissors	42
- Dressing Forceps	90
STITCH , Delicate Scissors	19
Measuring Instruments	4 - 5
SWEDESH MOD. , Needle Holders	149

T

TAKAHASHI , Bone Cutting Forceps	274
TAYLOR , Tissue Forceps	102
TENNANT , Tissue Forceps	100
TESSIER , Osteotome	239, 241
THOREK , Operating Scissors	38
TIECK-HALLE , Nasal Specula	200
TOBOLD , Tongue Forceps	169
TOENNIS , Operating Scissors	38
TOENNIS-ADSON , Operating Scissors	38, 64
TROELTSH , Tissue Forceps	105
TUFFIER , Retractors	168
TUOHY , Biopsy Needle	303

U

UNIVERSAL , Cotton Applicators	161
UNNA , Curettes	262

V

VANNAS , Micro Scissors	15
VARADY , Vein Stripper	195
VERESS , Biopsy Needles	303
VIDAL , Curettes	263
WISE , Micro Forceps	79
VOLKMANN , Curettes	262, 265

W

WALTER , Osteotome	231
WALTON , Delicate Scissors	19, 34
- Periosteal	213
WANGESTEEN , Tissue Forceps	102
WARWICK-JAMES , Nail Scissors	306
WEBSTER , Needle Holders	145
WEIL-BLAKESLEY , Bone cutting Forceps	274
WEITLANER , Retractors	192, 193
WERTHEIMER , Suction Tubes	293
WEST , Osteotome - Gouges	228
WESTCOTT , Micro Scissors	15
WHITEHEAD-JENNINGS , Mouth gags	165
WIEDER , Tongue Forceps	169
WIENER , Micro Retractors	174
WILLIGER , Curettes	261, 265
- Elevator	205
- Surgical Mallets	248
WILMER , Forbici delicate	22
WULLSTEIN , Retractors	192
- Micro Ear forceps	158

Y

YANCOSKIE , Retractor	190
YANKAUER , Dissector	206
- Wire Guides	159
YASARGIL , Micro Scissors	16

Z

ZAUFAL-JANSEN , Bone cutting Forceps	273
---	-----

A

ADSON , Cannule per aspirazione	293
- Divaricatore	193
- Periostotomo	218
- Pinzette chirurgiche	87, 88, 101, 104
ADSON-BROWN , Pinzette chirurgiche	87, 88
ALDERDYCE , Periostotomi	209
ALLIS , Pinze per tessuti	110
ALM , Divaricatori	191
Apribocca	165 - 168
ARKANSAS , Pietre ed accessori	310
ARRUGA , Port'aghi	154
ASCH , Rinologia	282
AUFRIEHT , Divaricatori	170, 197
- Lime per osso	257
AUFRIEHT-WALTER , Divaricatori	170
AUSTIN , Pinzette chirurgiche	86
AXENFELD , Divaricatori	176
AYERS , Micro Pinzette	99

B

BABBUSH , Periostotomi	209
BABY-ADSON , Pinze emostatiche per preparazione e legature	127
BABY-ALLIS , Pinze per tessuti	110
BABY-CRILE , Pinze emostatiche	120
BABY-CRILE-WOOD , Port'aghi	147
BABY-METZENBAUM , Forbici delicate	34
BABY-MIXTER , Pinze emostatiche per preparazione e legature	127
BACKHAUS , Fissateli	112
BALLENGER , Osteotomo	225
- Bisturi	12
- Rinologia	238
BALLENGER-HAYEK , Periostotomo	211
BARON , Cannule per aspirazione	291
BARRAQUER , Divaricatore	174
- Micro Port'aghi	134, 136
- Pinzette depilatorie	106
BARTH , Curette	261
BEASLEY-BACOCK , Pinzetta chirurgica	87
BEAUPRE , Pinzette depilatorie	106
BECKMANN , Speculum nasale	200
BEER , Pinzette depilatorie	106
BELLUCCI , Cannule per aspirazione	291
- Micro Pinze auricolari	158
BENGOLEA , Pinze emostatiche	126
BERGMANN , Martello chirurgico	249
BEYER , Pinze ossivore	273
BIEMER , Approssimatori	157
- Clamps vascolari	155
BIEMER-MÜLLER , Approssimatori	157
BIRCHER-GANSKE , Chirurgia ossea	276
BIRKETT , Pinze emostatiche	126
BIRO , Forbici delicate	22
BISHOP-HARMON , Micro Pinzette	100
Bisturi	6 - 12
BLUMENTHAL , Pinze ossivore	270
BÖHLER , Pinze ossivore	275
BOIES , Rinologia	283
BONN , Micro Pinzette	100
BONNEY , Pinzette chirurgiche	102
BOYNTON , Port'aghi	154
BOWMANN , Sonde bottonute	160
BRAUN , Pinza emostatica	114
BROCK , Micro Forbici	17
- Micro Pinzette	81
- Micro Port'aghi	133
BRÜNINGS , Bisturi	12
BRUNS , Curette	264
BUCKLEY , Osteotomo	224
BUNT , Pinze per sterilizzazione	316

C

Cannule d'aspirazione	287 - 302
------------------------------	-----------

CAPLAN , Forbici ossivore	47
- Rinologia	283
CARTER , Periostotomo	212
CASPAR , Manico per bisturi	9
CASTROVIEJO , Micro Port'aghi	136, 137
- Port'aghi	138, 140
- Strumenti per misurazione	4
CHADWICK , Forbici delicate	22
CHEATTLE , Pinze per sterilizzazione	316
CINELLI , Forbici delicate	34
- Rinologia	233
COLLIN , Pinze per sterilizzazione	316
CONVERSE , Bisturi	11
- Divaricatori	172
- Lime per osso	254
- Port'aghi	145
CONWAY , Divaricatori	179
CORN , Pinzette chirurgiche	86
CORONAL , Divaricatore	190
COTTLE , Bisturi	11
- Divaricatori	172, 175, 177, 179
- Forbici chirurgiche	23, 46, 64
- Lima per osso	257
- Martello chirurgico	249
- Micro Pinzette	99
- Osteotomi	230, 236, 237
- Periostotomi	210, 211, 212
- Rinologia	201
- Strumento per cartilagine	175
COTTLE-KNAPP , Forbici delicate	24
COTTLE-MASING , Forbici delicate	22
COTTLE-NEIVERT , Divaricatore	175
COTTLE-WALSHAM , Rinologia	282
CRAIG , Rinologia	283
CRILE , Pinze emostatiche	119, 120
CRILE-MURRAY , Port'aghi	141
CRILE-WOOD , Port'aghi	141, 147, 153
Curette	261 - 265
CUSHING , Divaricatori	178, 181, 182
- Periostotomo	218
- Pinzette chirurgiche	93, 102
CUSHING-KOCHER , Divaricatore	182

D

DANDY , Pinze emostatiche	119
DAVIS , Dissettori - Separatori	206
- Pinze per sterilizzazione	315
DAVIS-BOYLE , Apri bocca	166
DEAN , Forbici chirurgiche	45
DEAVER , Forbici chirurgiche	32
- Divaricatori	184
DERF , Port'aghi	141, 145
DESMARRES , Divaricatori	179
- Divaricatore isolato	130
- Micro Pinzette	99
DE BAKEY , Pinzette atraumatiche	96, 97, 98
- Pinzette chirurgiche	103
- Port'aghi	150
DE MARTEL , Pinza emostatica delicata	111
DIEFFENBACH , Clamps	155
DIETRICH , Port'aghi	138
DINGMANN , Apri bocca	167
- Chirurgia ossea	276
- Lime per osso	256
Dissettori	205 - 208
Divaricatori	172 - 197
DIXON-LOVELACE , Pinze emostatiche	126
DUNN-DAUTREY , Divaricatori	171
DUPLAY , Speculum nasale	3

E

ELSCHNIG , Pinzette chirurgiche	100
EPKER , Osteotomi	235

F

FACE-LIFT , Forbici chirurgiche	67, 69
- Forbici Wellenschliff	70
FAGER , Dissettori - Separatori	206
FARABEUF , Divaricatore	180
- Periostotomi	219
FARABEUF-COLLIN , Raspatore	219
FAULKNER , Rinologia	232
FAURE , Fissateli	112
FEICHENFELD , Pinzette per frammenti e schegge	106
FERGUSSON , Cannule per aspirazione	290
FERRIS-SMITH-CUSHING , Pinze ossivore	274
FINSEN , Divaricatori	191
FOERSTER-BALLENGER , Pinze per tamponi	115
FOMON , Bisturi	11
- Divaricatori	175
- Forbici chirurgiche	45, 46, 64
- Forbici delicate	34
- Lime per osso	255, 259
- Periostotomo	213
- Rinologia	233
Forbici	15 - 75
FOSTER-GILLIES , Port'aghi	144
FOX , Curette	263
FRAZIER , Cannule per aspirazione	290, 293
FREEMAN , Divaricatori	190
- Forbici chirurgiche	66, 71
- Forbici Wellenschliff	72
FREEMAN-GORNEY , Forbici chirurgiche	66, 71
FREEMAN-KAYE , Forbici chirurgiche	66, 67, 73
FREER , Battitori - Osteotomi	223
- Bisturi	12
- Micro Divaricatore	175
- Periostotomi	209, 212, 213, 216
FRIEDMANN , Pinze ossivore	270, 271

G

GALLAHER , Lime per osso	256
GEMINI , Pinze emostatiche	129
GERALD , Pinzette chirurgiche	95, 104
GERALD-BROWN , Pinzette chirurgiche	95
GIDEF , Pinzette emostatiche delicate	118
GIESSEN , Divaricatori	180
GILLIES , Micro divaricatori	173
- Pinzette atraumatiche	98
- Port'aghi	144, 148
GIUNTA-NASAL , Forbici Wellenschliff	70
GLASSMAN , Forbici chirurgiche	27
GOLDMANN , Rinologia	283
GOLDMAN-FOX , Forbici chirurgiche	25, 49, 53
- Forbici delicate	25
GOOD , Forbici per tonsille	43
GORNEY , Cannule per aspirazione	289
- Divaricatore	190
- Forbici chirurgiche	43, 73
- Forbici ossivore	47
- Forbici Wellenschliff	67, 68, 70, 72
GRAEFE , Forbici delicate	22
- Micro Pinzette da fissazione	99
- Pinzette chirurgiche	86, 100
GREEN , Micro Pinzette da fissazione	99
GREENBERG-PAR , Forbici nasali	48, 54
GREGORY , Forbici chirurgiche	69
GROSS , Pinze per tamponi	115
GRÜENWALD , Pinzette auricolari	105
GULLIEN , Cannule per aspirazione	289
GUTHRIE , Micro divaricatori	173, 174

H

HABERER , Divaricatori	168
HALSEY , Port'aghi	141, 145
HALSTED , Pinze emostatiche	120
- Pinze emostatiche delicate	118

HALSTED-MOSQUITO , Pinze emostatiche	120
- Pinze emostatiche delicate	117
HARRINGTON , Divaricatori	185
HARTMANN , Abbassa lingua	169
- Cannule per aspirazione	294
- Rinologia	198, 199
- Speculum per adulti	3
HARTMANN-BABY-MOSQUITO , Pinze emostatiche	117
HEANEY(HEGAR) , Port'aghi	142
HEGAR , Port'aghi	142, 146
HEGAR-MAYO-SEELEY , Port'aghi	153
HEISS , Pinze emostatiche	126
HENAHAN , Periostotomo	218
HEYMANN , Forbici chirurgiche	46
HEYMANN-KNIGHT , Forbici chirurgiche	45
HOUSE , Cannule per aspirazione	292
- Divaricatore	178
HOWARD , Lime per osso	253
HOWARTH , Periostotomo	211
HUNT , Micro pinzette	99
HUNTER , Pinzette per frammenti e schegge	106

I

IRIS , Forbici chirurgiche	50, 53
- Forbici delicate	20
- Forbici per mancini	52
- Forbici Wellenschliff	65

J

JACOBSON , Curette	261
- Micro forbici	16
- Micro Port'aghi	135
- Port'aghi	139
JACOBSON-MICRO , Pinze emostatiche delicate	111
JAEGER , Micro Divaricatori	174
JAMESON , Forbici chirurgiche	23
JAMESON-WERBER , Forbici chirurgiche	23
JANSEN , Curette	261
- Pinze ossivore	272
- Pinzette auricolari	105
- Raspatore	219
JONES , Fissateli	112, 114
JOSEPH , Bisturi	11, 12
- Divaricatore	175
- Forbici chirurgiche	33, 64
- Lime per osso	256
- Periostotomi	212, 213, 218
- Rinologia	258

K

KAHN , Forbici chirurgiche	44
KAYE , Forbici delicate	19
KAYE-FACE-LIFT , Forbici chirurgiche	71
KELLY , Forbici chirurgiche	28, 54
- Pinze emostatiche	123
KERPEL , Curette	263
KERSHNER , Micro Divaricatori	173
KEYES , Rinologia	263
KILLIAN , Osteotomo	225
- Cannule per aspirazione	295
- Periostotomo	211
- Rinologia	198, 199, 283
KILLIAN-KLAUS , Osteotomo	225
KILNER , Divaricatori	172
- Forbici chirurgiche	23, 27, 48, 54
- Forbici Wellenschliff	70
KILNER-DOUGHTY , Apri bocca	165
KIRBY , Divaricatori	175, 179
KLAR-EVATEUR , Divaricatore	179
KLEINERT-KUTZ , Pinze ossivore	273
KNAPP , Micro divaricatore	174
KOCHER , Divaricatori	182
- Pinze emostatiche	121, 123, 125

Alphabetisches Inhaltsverzeichnis	Alphabetical index	Indice alfabetico	Indice alfabetico	Index alphabétiques
KOCHER-OCHSNER , Pinze emostatiche		122	MILLER , Lime per osso	253
KÖNIG , Elevatori		205	MILLIGAN , Dissettori - Separatori	206
KRESSNER , Rinologia		282	MINI-FRIEDMANN , Pinze ossivore	269, 270
KUHNT , Pinzette Chirurgiche		100	MINI-GILLIES , Port'aghi	144, 148
L			MINI-LAMBOTTE , Osteotomi	229
LA GRANGE , Forbici delicate	25, 49		MINI-LEXER , Osteotomo	244
LAMBERT , Micro Pinzette	99		MINI-MALTZ , Lime per osso	259
LAMBOTTE , Periostotomi - Raspatori	242		MINI-OLSEN-HEGAR , Port'aghi	143
LANGENBECK , Periostotomi	209, 219		MINI-ROUX , Divaricatori	181
Laringoscopi	3		MOD. MARTIN , Porta cotone	161
LEMPERT , Pinze ossivore	271		MODELL WIEN , Speculum nasale	200
LERICHE , Pinze emostatiche	119		MOLT , Periostotomo	218
LEXER , Osteotomi	245		MÜLLER , Approssimatori	157
- Forbici chirurgiche	41, 62		N	
LEWIS , Lime per osso	257		NEIVERT , Divaricatori	177
LICHTENBERG , Port'aghi	154		NELSON-METZENBAUM , Forbici chirurgiche	37
LIEBERMANN-TENNANT , Micro Divaricatori	173		NEWS , Divaricatore	178
Lime per osso	253 - 260		NOYES , Micro forbici	15
LISTER , Pinze emostatiche	114		NUBOER , Cannule per aspirazione	288
LISTON , Pinze ossivore	275		O	
LITTAUER , Pinzette depilatorie	106		OBWEGESER , Aghi per legature	159
LITTLER , Forbici delicate	34		- Divaricatori	170, 183
LOCKLIN , Forbici chirurgiche	24, 28		- Osteotomi	247
LOCKLIN MOD. , Forbici chirurgiche	24		- Periostotomi	215, 217
LOGAN , Divaricatori	191		O'BRIEN , Forbici per suture	74
LORNA , Fissateli	113		O'CONNOR , Divaricatori	174
LOVE , Divaricatori	178		OLIVECRONA , Dissettori - Separatori	207
LUCAE , Martello chirurgico	248		- Pinze ossivore	272
- Pinzette auricolari	105		OLSEN-HEGAR , Port'aghi	143, 149
LUENEBURG , Elevatori	205		OMBREDANNE , Martello chirurgico	249
LUER , Divaricatore	178		Osteotomi	223 - 248
- Pinze ossivore	272		ORINGER , Apri bocca	169
M			OVERHOLT , Pinze emostatiche	128
MacCOLLUM-DINGMAN , Dissettori	189		OVERHOLT-GEISSENDORFER , Pinze emostatiche	128
MAGILL , Cannule per aspirazione	295		P	
MAIER , Pinze per tamponi	116		PARKER-LANGENBECK , Divaricatore	180
MALINIAC , Retrattore nasale	197		PAR-TYPE , Forbici nasali	54
MALTZ , Bisturi	12		PARTSCH , Osteotomi - Scalpelli	227, 228
- Lime per osso	259		PAPAVERO-HARTMANN , Rinologia	201
- Rinologia	260		PAUL , Divaricatori	176
MARTINI , Curette	261		PEAN , Pinze emostatiche	121, 124
Martelli chirurgici	249 - 250		- Pinze emostatiche delicate	118
MASING , Bisturi	12		PEAN-MURPHY , Pinze emostatiche	114
- Periostotomi	210, 212		PECK-JOSEPH , Forbici chirurgiche	53
- Rinologia	233		PEET , Pinze emostatiche delicate	111
MATHIEU , Port'aghi	154		PENFIELD , Dissettori	208
MAYO , Forbici chirurgiche	39, 40, 51, 63		PENNINGTON , Periostotomo	211
- Pinze per sterilizzazione	316		Periostotomi	209 - 219
MAYO-HEGAR , Port'aghi	142, 146		PERRY , Pinzette per dissezione	85
MAYO-HEGAR-FINO , Port'aghi	147		PIERCE , Periostotomo	211
MAYO-HEGAR-HEANEY , Port'aghi	146		Pinze emostatiche	109 - 130
MAYO-LEXER , Forbici chirurgiche	63		Pinzette	79 - 106
MAYO-NOBLE , Forbici chirurgiche	39		PITANGUI , Marcatore	109
MAYO-STILLE , Forbici chirurgiche	42, 62		PLESTER , Cannule per aspirazione	290
MC DONALD , Periostotomo	216		- Divaricatori	194
MC INDOE , Rinologia	232		Port'aghi	133 - 154
- Pinze atraumatiche	98		POTTS-SMITH , Pinzette chirurgiche	92, 102
MC INTOSH , Set laringoscopi	3		POTTS-YASARGIL , Micro forbici	16
MC IVOR , Apri bocca	166		Q	
MC KENTY , Periostotomi	211, 213		QUINBY , Forbici delicate	22
MC PHERSON , Pinzette chirurgiche	100		QUINKE , Aghi da biopsia	303
MEAD , Martello chirurgico	248		R	
- Periostotomo	209		RADOLF , Chirurgia della mano	280
- Pinze ossivore	270		RAGNELL , Divaricatori	180
MEDHORN , Clamps vascolari	155			
METZENBAUM , Forbici chirurgiche	33, 35, 36, 48, 50, 58			
- Forbici Wellenschliff	65			
METZENBAUM-FINO , Forbici chirurgiche	35, 36, 53, 59, 60, 61			
MICRO-HALSTED , Pinze emostatiche delicate	117			
MICRO-IRIS , Forbici delicate	20			
MICRO-RYDER , Port'aghi	151, 152			
MICRO-VASCULAR , Port'aghi	150			
MILLARD , Divaricatori	172, 190			

- Micro Forbici delicate	19
RAGNELL-DAVIS , Divaricatori	180
RAMPLEY , Pinze per tamponi	116
RANKIN , Pinze emostatiche	123
REYNOLDS , Forbici delicate	26
Rinologia	198 - 201
ROCHESTER-PEAN , Pinze emostatiche	122, 129
ROGER , Periostotomo	211
ROGGE , Pinze per sterilizzazione	315
ROLLET , Micro Divaricatori	174
ROWE , Pinze per riposizione	281
ROSE , Divaricatore	178
ROSTKOWSKI , Divaricatori	179
ROUX , Divaricatori	181
ROUX-MAGNUS , Divaricatori	181
RUBIN , Rinologia	234, 282
RUSKIN , Pinze ossivore	273
RUSKIN-LISTON , Pinze ossivore	275
RUSKIN-STILLE , Pinze ossivore	273
RYDER , Port'aghi	152

S

SAALFELD , Schiaccia comedoni	262
SACHS , Dissettori - Separatori	206
SALZBURG , Periostotomi	210
SAROT , Port'aghi	149
SAUG-RASPATORIUM , Cannule per aspirazione	289
SCHAEDEL , Fissateli	112
SCHEDE , Curette	264
SCHNEIDER , Periostotomo	219
SCHNEIDER-SAUERBRUCH , Periostotomi - Raspatori	242
SCHWACKENDIEK , Forbici per tonsille	43
SCOVILLE , Divaricatori	182
SEDILLOT , Periostotomo	214, 219
SEMKEN , Pinzette chirurgiche	87, 92, 101
SENN-GREEN , Divaricatori	180
SENN-MILLER , Divaricatori	177
SEWALL , Periostotomo	212
SHEA , Forbici chirurgiche	33
SHEEHAN , Osteotomi	226
SILVER , Rinologia	232
SIMON , Divaricatore	184
SPENCER , Forbici per suture	74
STACKE , Sonde bottonute	160
STEINHÄUSER , Periostotomi	217
STELLA , Forbici chirurgiche	68
STELLBRINK , Pinze ossivore	269, 271
STEVENS , Forbici delicate	19, 26, 48
STILLE , Forbici chirurgiche	42
- Pinzette anatomiche	90
STITCH , Forbici delicate	19
Strumenti per misurazione	4 - 5
SWEDESH MOD. , Port'aghi	149

T

TAKAHASHI , Pinze ossivore	274
TAYLOR , Pinzette chirurgiche	102
TENNANT , Pinzette chirurgiche	100
TESSIER , Osteotomi	239, 241
THOREK , Forbici chirurgiche	38
TIECK-HALLE , Speculum nasale	200
TOBOLD , Abbassalingua	169
TOENNIS , Forbici chirurgiche	38
TOENNIS-ADSON , Forbici chirurgiche	38, 64
TROELTSH , Pinzette auricolari	105
TUFFIER , Divaricatori	168
TUOHY , Aghi da biopsia	303

U

UNIVERSAL , Porta cotone	161
UNNA , Schiaccia comedoni	262

V

VANNAS , Micro forbici	15
VARADY , Uncini per vene	195
VERESS , Aghi da biopsia	303
VIDAL , Curette	263
WISE , Micro Pinzette	79
VOLKMANN , Curette	262, 265

W

WALTER , Osteotomi	231
WALTON , Forbici delicate	19, 34
- Periostotomo	213
WANGESTEEN , Pinzette chirurgiche	102
WARWICK-JAMES , Tronchesi per unghie	306
WEBSTER , Port'aghi	145
WEIL-BLAKESLEY , Pinze ossivore	274
WEITLANER , Divaricatori	192, 193
WERTHEIMER , Cannule per aspirazione	293
WEST , Osteotomi - Scalpelli	228
WESTCOTT , Micro forbici	15
WHITEHEAD-JENNINGS , Apri bocca	165
WIEDER , Abbassalingua	169
WIENER , Micro divaricatori	174
WILLIGER , Curette	261, 265
- Elevatori	205
- Martello chirurgico	248
WILMER , Forbici delicate	22
WULLSTEIN , Divaricatori	192
- Micro Pinze auricolari	158

Y

YANCOSKIE , Divaricatore	190
YANKAUER , Dissetto	206
- Passafili	159
YASARGIL , Micro forbici	16

Z

ZAUFAL-JANSEN , Pinze ossivore	273
---------------------------------------	-----

Alphabetisches Inhaltsverzeichnis	Alphabetical index	Indice alfabetico	Indice alfabetico	Index alphabétiques
A				
ADSON , Cànulas aspiradoras	293			
- Separadores	193			
- Periostotomos	218			
- Pinzas quirùrgicas	87, 88, 101, 104			
ADSON-BROWN , Pinzas quirùrgicas	87, 88			
ALDERDYCE , Periostotomos	209			
ALLIS , Pinzas para coger las encias	110			
ALM , Separadores	191			
Abrebocas	165 - 168			
ARKANSAS , Accesorios para el reafilado	310			
ARRUGA , Portaagujas	154			
ASCH , Rinologìa	282			
AUFRIEHT , Separadores	170, 197			
- Limas para huesos	257			
AUFRIEHT-WALTER , Separadores	170			
AUSTIN , Pinzas quirùrgicas	86			
AXENFELD , Separadores	176			
AYERS , Pinzas finos	99			
B				
BABBUSH , Periostotomos	209			
BABY-ADSON , Pinzas hemostàticas y para ligadura	127			
BABY-ALLIS , Pinzas para coger las encias	110			
BABY-CRILE , Pinzas hemostàticas	120			
BABY-CRILE-WOOD , Portaagujas	147			
BABY-METZENBAUM , Tijeras finas	34			
BABY-MIXTER , Pinzas hemostàticas y para ligadura	127			
BACKHAUS , Pinzas de campo	112			
BALLENGER , Batidor - Osteòtomos	225			
- Bisturies	12			
- Rinologìa	238			
BALLENGER-HAYEK , Periostotomos	211			
BARON , Cànulas aspiradoras	291			
BARRAQUER , Separadores	174			
- Micro portaagujas	134, 136			
- Pinzas depilatorie	106			
BARTH , Cucharillas cortantes	261			
BEASLEY-BACOCK , Pinzas quirùrgicas	87			
BEAUPRE , Pinzas depilatorie	106			
BECKMANN , Espèculos nasales	200			
BEER , Pinzas depilatorie	106			
BELLUCCI , Cànulas aspiradoras	291			
- Pinzas auricolares finas	158			
BENGOLEA , Pinzas hemostàticas	126			
BERGMANN , Martillos quirùrgicos	249			
BEYER , Pinzas para huesos	273			
BIEMER , Aproximatores	157			
- Clamps vasculares	155			
BIEMER-MÜLLER , Aproximatores	157			
BIRCHER-GANSKE , Pinzas para Cirugia ósea	276			
BIRKETT , Pinzas hemostàticas	126			
BIRO , Tijeras finas	22			
BISHOP-HARMON , Micro Pinzas	100			
Bisturies	6 - 12			
BLUMENTHAL , Pinzas para huesos	270			
BÖHLER , Pinzas para huesos	275			
BOIES , Rinologìa	283			
BONN , Micro Pinzas	100			
BONNEY , Pinzas quirùrgicas	102			
BOYNTON , Portaagujas	154			
BOWMANN , Estiletes	160			
BRAUN , Pinzas hemostàticas	114			
BROCK , Micro Tijeras	17			
- Micro Pinzas	81			
- Micro Portaagujas	133			
BRÜNINGS , Bisturies	12			
BRUNS , Cucharillas cortantes	264			
BUCKLEY , Osteòtomos	224			
BUNT , Pinzas para esterilizaciòn	316			
C				
Cànulas aspiradoras	287 - 302			
CAPLAN , Tijeras para huesos	47			
- Rinologìa	283			
CARTER , Periostotomos	212			
CASPAR , Mango de bisturies	9			
CASTROVIEJO , Micro portaagujas	136, 137			
- Portaagujas	138, 140			
- Instrumentos para medir	4			
CHADWICK , Tijeras finas	22			
CHEATTLE , Pinzas para esterilizaciòn	316			
CINELLI , Tijeras finas	34			
- Rinologìa	233			
COLLIN , Pinzas para esterilizaciòn	316			
CONVERSE , Bisturies	11			
- Separadores	172			
- Limas para huesos	254			
- Portaagujas	145			
CONWAY , Separadores	179			
CORN , Pinzas quirùrgicas	86			
CORONAL , Separadores	190			
COTTLE , Bisturies	11			
- Separadores	172, 175, 177, 179			
- Tijeras quirùrgicas	23, 46, 64			
- Limas para huesos	257			
- Martillos quirùrgicos	249			
- Micro Pinzas	99			
- Osteòtomos	230, 236, 237			
- Periostotomos	210, 211, 212			
- Rinologìa	201			
- Instrumentos para magullar cartilagos	175			
COTTLE-KNAPP , Tijeras finas	24			
COTTLE-MASING , Tijeras finas	22			
COTTLE-NEIVERT , Separadores	175			
COTTLE-WALSHAM , Rinologìa	282			
CRAIG , Rinologìa	283			
CRILE , Pinzas hemostàticas	119, 120			
CRILE-MURRAY , Portaagujas	141			
CRILE-WOOD , Portaagujas	141, 147, 153			
Cucharillas cortantes	261 - 265			
CUSHING , Separadores	178, 181, 182			
- Periostotomos	218			
- Pinzas quirùrgicas	93, 102			
CUSHING-KOCHER , Separadores	182			
D				
DANDY , Pinzas hemostàticas	119			
DAVIS , Disecadores - Descoladores	206			
- Pinzas pala sterilizaciòn	315			
DAVIS-BOYLE , Abrebocas	166			
DEAN , Tijeras quirùrgicas	45			
DEAVER , Tijeras quirùrgicas	32			
- Separadores	184			
DERF , Portaagujas	141, 145			
DESMARRES , Separadores	179			
- Separadores isolado	130			
- Micro Pinzas	99			
DE BAKEY , Pinzas atraumàticas	96, 97, 98			
- Pinzas quirùrgicas	103			
- Portaagujas	150			
DE MARTEL , Pinzas hemostàticas finas	111			
DIEFFENBACH , Clamps vasculares	155			
DIETRICH , Portaagujas	138			
DINGMANN , Abrebocas	167			
- Pinzas para Cirugia ósea	276			
- Limas para huesos	256			
Disecadores	205 - 208			
Separadores	172 - 197			
DIXON-LOVELACE , Pinzas hemostàticas	126			
DUNN-DAUTREY , Separadores	171			
DUPLAY , Espèculos nasales	3			
E				
ELSCHNIG , Pinzas quirùrgicas	100			
EPKER , Osteòtomos	235			

F

FACE-LIFT , Tijeras quirúrgicas	67, 69
- Tijeras Wellenschliff	70
FAGER , Disecadores - Descoladores	206
FARABEUF , Separadores	180
- Periostotomos	219
FARABEUF-COLLIN , Descoladores	219
FAULKNER , Rinología	232
FAURE , Pinzas de campo	112
FEICHENFELD , Pinzas para espinas	106
FERGUSSON , Cánulas aspiradoras	290
FERRIS-SMITH-CUSHING , Pinzas para huesos	274
FINSEN , Separadores	191
FOERSTER-BALLENGER , Pinzas para tampones	115
FOMON , Bisturíes	11
- Separadores	175
- Tijeras quirúrgicas	45, 46, 64
- Tijeras finas	34
- Limas para huesos	255, 259
- Periostotomos	213
- Rinología	233
Tijeras	15 - 75
FOSTER-GILLIES , Portaagujas	144
FOX , Cucharillas cortantes	263
FRAZIER , Cánulas aspiradoras	290, 293
FREEMAN , Separadores	190
- Tijeras quirúrgicas	66, 71
- Tijeras Wellenschliff	72
FREEMAN-GORNEY , Tijeras quirúrgicas	66, 71
FREEMAN-KAYE , Tijeras quirúrgicas	66, 67, 73
FREER , Batidor - Osteótomos	223
- Bisturíes	12
- Micro Separadores	175
- Periostotomos	209, 212, 213, 216
FRIEDMANN , Pinzas para huesos	270, 271

G

GALLAHER , Limas para huesos	256
GEMINI , Pinzas hemostáticas	129
GERALD , Pinzas quirúrgicas	95, 104
GERALD-BROWN , Pinzas quirúrgicas	95
GIDEF , Pinzas hemostáticas finas	118
GIESSEN , Separadores	180
GILLIES , Micro Separadores	173
- Pinzas Atraumáticas	98
- Portaagujas	144, 148
GIUNTA-NASAL , Tijeras Wellenschliff	70
GLASSMAN , Tijeras quirúrgicas	27
GOLDMANN , Rinología	283
GOLDMAN-FOX , Tijeras quirúrgicas	25, 49, 53
- Tijeras finas	25
GOOD , Tijeras para amígdalas	43
GORNEY , Cánulas aspiradoras	289
- Separadores	190
- Tijeras quirúrgicas	43, 73
- Tijeras para huesos	47
- Tijeras Wellenschliff	67, 68, 70, 72
GRAEFE , Tijeras finas	22
- Micro Pinzas	99
- Pinzas quirúrgicas	86, 100
GREEN , Micro Pinzas	99
GREENBERG-PAR , Tijeras	48, 54
GREGORY , Tijeras quirúrgicas	69
GROSS , Pinzas para tampones	115
GRUENWALD , Pinzas auriculares	105
GUILLIEN , Cánulas aspiradoras	289
GUTHRIE , Micro separadores	173, 174

H

HABERER , Separadores	168
HALSEY , Portaagujas	141, 145
HALSTED , Pinzas hemostáticas	120
- Pinzas hemostáticas finas	118

HALSTED-MOSQUITO , Pinzas hemostáticas	120
- Pinzas hemostáticas finas	117
HARRINGTON , Separadores	185
HARTMANN , Bejalenguas	169
- Cánulas aspiradoras	294
- Rinología	198, 199
- Espéculos para adultos	3
HARTMANN-BABY-MOSQUITO , Pinzas hemostáticas	117
HEANEY(HEGAR) , Portaagujas	142
HEGAR , Portaagujas	142, 146
HEGAR-MAYO-SEELEY , Portaagujas	153
HEISS , Pinzas hemostáticas	126
HENAHAN , Periostotomos	218
HEYMANN , Tijeras quirúrgicas	46
HEYMANN-KNIGHT , Tijeras quirúrgicas	45
HOUSE , Cánulas aspiradoras	292
- Separadores	178
HOWARD , Limas para huesos	253
HOWARTH , Periostotomos	211
HUNT , Micro Pinzas	99
HUNTER , Pinzas para espinas	106

I

IRIS , Tijeras quirúrgicas	50, 53
- Tijeras finas	20
- Tijeras para zurdos	52
- Tijeras Wellenschliff	65

J

JACOBSON , Cucharillas cortante	261
- Micro Tijeras	16
- Micro Portaagujas	135
- Portaagujas	139
JACOBSON-MICRO , Pinzas hemostáticas finas	111
JAEGER , Micro Separadores	174
JAMESON , Tijeras quirúrgicas	23
JAMESON-WERBER , Tijeras quirúrgicas	23
JANSEN , Cucharillos cortantes	261
- Pinzas para huesos	272
- Pinzas auriculares	105
- Descoladores	219
JONES , Pinzas de campo	112, 114
JOSEPH , Bisturíes	11, 12
- Separadores	175
- Tijeras quirúrgicas	33, 64
- Limas para huesos	256
- Periostotomos	212, 213, 218
- Rinología	258

K

KAHN , Tijeras quirúrgicas	44
KAYE , Tijeras finas	19
KAYE-FACE-LIFT , Tijeras quirúrgicas	71
KELLY , Tijeras quirúrgicas	28, 54
- Pinzas hemostáticas	123
KERPEL , Cucharillos cortantes	263
KERSCHNER , Micro Separadores	173
KEYES , Rinología	263
KILLIAN , Osteótomos	225
- Cánulas aspiradoras	295
- Periostotomos	211
- Rinología	198, 199, 283
KILLIAN-KLAUS , Osteótomos	225
KILNER , Separadores	172
- Tijeras quirúrgicas	23, 27, 48, 54
- Tijeras Wellenschliff	70
KILNER-DOUGHTY , Abrebocas	165
KIRBY , Separadores	175, 179
KLAR-EVATEUR , Separadores	179
KLEINERT-KUTZ , Pinzas para huesos	273
KNAPP , Micro Separadores	174
KOCHER , Separadores	182
- Pinzas hemostáticas	121, 123, 125

Alphabetisches Inhaltsverzeichnis	Alphabetical index	Indice alfabetico	Indice alfabetico	Index alphabétiques
KOCHER-OCHSNER , Pinzas hemostáticas		122	MILLER , Limas para huesos	253
KÖNIG , Elevadores		205	MILLIGAN , Disecadores - Descoladores	206
KRESSNER , Rinología		282	MINI-FRIEDMANN , Pinzas para huesos	269, 270
KUHNT , Pinzas quirúrgicas		100	MINI-GILLIES , Portaagujas	144, 148
L				
LA GRANGE , Tijeras finas		25, 49	MINI-LAMBOTTE , Osteòtomos	229
LAMBERT , Micro Pinzas		99	MINI-LEXER , Osteòtomos	244
LAMBOTTE , Periostotomos		242	MINI-MALTZ , Limas para huesos	259
LANGENBECK , Periostotomos		209, 219	MINI-OLSEN-HEGAR , Portaagujas	143
Laringoscopios		3	MINI-ROUX , Separadores	181
LEMPERT , Pinzas para huesos		271	MOD. MARTIN , Porta-algodòn	161
LERICHE , Pinzas hemostáticas		119	MODELL WIEN , Espéculos nasales	200
LEXER , Osteòtomos		245	MOLT , Periostòtomos	218
- Tijeras quirúrgicas		41, 62	MÜLLER , Aproximadores	157
LEWIS , Limas para huesos		257	N	
LICHTENBERG , Portaagujas		154	NEIVERT , Separadores	177
LIEBERMANN-TENNANT , Micro Separadores		173	NELSON-METZENBAUM , Tijeras quirúrgicas	37
Limas para huesos		253 - 260	NEWS , Separadores	178
LISTER , Pinzas hemostáticas		114	NOYES , Micro Tijeras	15
LISTON , Pinzas para huesos		275	NUBOER , Cànulas aspiradoras	288
LITTAUER , Pinzas depilatorie		106	O	
LITTLER , Tijeras finas		34	OBWEGESER , Agujas para ligaduras	159
LOCKLIN , Tijeras quirúrgicas		24, 28	- Separadores	170, 183
LOCKLIN MOD. , Tijeras quirúrgicas		24	- Osteotòmos	247
LOGAN , Separadores		191	- Periostòtomos	215, 217
LORNA , Pinzas de campo		113	O'BRIEN , Tijeras para sutura	74
LOVE , Separadores		178	O'CONNOR , Micro Separadores	174
LUCAE , Martillos quirúrgicos		248	OLIVECRONA , Disecadores - Descoladores	207
- Pinzas auricolares		105	- Pinzas para huesos	272
LUENEBURG , Elevadores		205	OLSEN-HEGAR , Portaagujas	143, 149
LUER , Separadores		178	OMBREDANNE , Martillos quirúrgicos	249
- Pinzas para huesos		272	Osteòtomos	223 - 248
M				
MacCOLLUM-DINGMAN , Disecadores		189	ORINGER , Abrebocas	169
MAGILL , Cànulas aspiradoras		295	OVERHOLT , Pinzas hemostáticas	128
MAIER , Pinzas para tampones		116	OVERHOLT-GEISSENDORFER , Pinzas hemostáticas	128
MALINIAC , Separadores		197	P	
MALTZ , Bisturies		12	PARKER-LANGENBECK , Separadores	180
- Limas para huesos		259	PAR-TYPE , Tijeras nasal	54
- Rinología		260	PARTSCH , Osteòtomos	227, 228
MARTINI , Cucharillo cortantes		261	PAPAVERO-HARTMANN , Espéculos nasale	201
Martillos quirúrgicos		249 - 250	PAUL , Separadores	176
MASING , Bisturies		12	PEAN , Pinzas hemostáticas	121, 124
- Periostotomos		210, 212	- Pinzas hemostáticas finas	118
- Rinología		233	PEAN-MURPHY , Pinzas hemostáticas	114
MATHIEU , Portaagujas		154	PECK-JOSEPH , Tijeras quirúrgicas	53
MAYO , Tijeras quirúrgicas		39, 40, 51, 63	PEET , Pinzas hemostáticas finas	111
- Pinzas para esterilizaciòn		316	PENFIELD , Disecadores	208
MAYO-HEGAR , Portaagujas		142, 146	PENNINGTON , Periostòtomos	211
MAYO-HEGAR-FINO , Portaagujas		147	Periostòtomos	209 - 219
MAYO-HEGAR-HEANEY , Portaagujas		146	PERRY , Pinzas para disecion	85
MAYO-LEXER , Tijeras quirúrgicas		63	PIERCE , Periostòtomos	211
MAYO-NOBLE , Tijeras quirúrgicas		39	Pinzas hemostáticas	109 - 130
MAYO-STILLE , Tijeras quirúrgicas		42, 62	Pinzas	79 - 106
MC DONALD , Periostotomos		216	PITANGUI , Marcador	109
MC INDOE , Rinología		232	PLESTER , Cànulas aspiradoras	290
- Pinzas Atraumaticas		98	- Separadores	194
MC INTOSH , Set Laringoscopios		3	Portaagujas	133 - 154
MC IVOR , Abrebocas		166	POTTS-SMITH , Pinzas quirúrgicas	92, 102
MC KENTY , Periostotomos		211, 213	POTTS-YASARGIL , Micro Tijeras	16
MC PHERSON , Pinzas quirúrgicas		100	Q	
MEAD , Martillos quirúrgicos		248	QUINBY , Tijeras finas	22
- Periostotomos		209	QUINKE , Agujas para biopsia	303
- Pinzas para huesos		270	R	
MEDHORN , Clamps Vasculares		155	RADOLF , Pinza para arrancar uñas	280
METZENBAUM , Tijeras quirúrgicas		33, 35, 36, 48, 50, 58	RAGNELL , Separadores	180
- Tijeras Wellenschliff		65		
METZENBAUM-FINO , Tijeras quirúrgicas		35, 36, 53, 59, 60, 61		
MICRO-HALSTED , Pinzas hemostáticas finas		117		
MICRO-IRIS , Tijeras finas		20		
MICRO-RYDER , Portaagujas		151, 152		
MICRO-VASCULAR , Portaagujas		150		
MILLARD , Separadores		172, 190		

Alphabetisches Inhaltsverzeichnis	Alphabetical index	Indice alfabetico	Indice alfabetico	Index alphabétiques
- Micro Tijeras finas		19		
RAGNELL-DAVIS , Separadores		180		
RAMPLEY , Pinzas para tampones		116		
RANKIN , Pinzas hemostáticas		123		
REYNOLDS , Tijeras finas		26		
Rinología		198 - 201		
ROCHESTER-PEAN , Pinzas hemostáticas		122, 129		
ROGER , Periostótomos		211		
ROGGE , Pinzas para esterilización		315		
ROLLET , Micro Separadores		174		
ROWE , Pinza para huesos		281		
ROSE , Separadores		178		
ROSTKOWSKI , Separadores		179		
ROUX , Separadores		181		
ROUX-MAGNUS , Separadores		181		
RUBIN , Rinología		234, 282		
RUSKIN , Pinzas para huesos		273		
RUSKIN-LISTON , Pinzas para huesos		275		
RUSKIN-STILLE , Pinzas para huesos		273		
RYDER , Portaagujas		152		

S

SAALFELD , Cucharillos cortantes		262		
SACHS , Disecadores - Descoladores		206		
SALZBURG , Periostótomos		210		
SAROT , Portaagujas		149		
SAUG-RASPIORIUM , Cánulas aspiradoras		289		
SCHAEDEL , Pinzas de campo		112		
SCHAEDE , Cucharillos cortantes		264		
SCHNEIDER , Periostótomos		219		
SCHNEIDER-SAUERBRUCH , Periostótomos		242		
SCHWACKENDIEK , Tijeras para amigdales		43		
SCOVILLE , Separadores		182		
SEDILLOT , Periostótomos		214, 219		
SEMKEN , Pinzas quirúrgicas		87, 92, 101		
SENN-GREEN , Separadores		180		
SENN-MILLER , Separadores		177		
SEWALL , Periostótomos		212		
SHEA , Tijeras quirúrgicas		33		
SHEEHAN , Osteotomos		226		
SILVER , Rinología		232		
SIMON , Separadores		184		
SPENCER , Tijeras para ligadura		74		
STACKE , Estiletes		160		
STEINHÄUSER , Periostótomos		217		
STELLA , Tijeras quirúrgicas		68		
STELLBRINK , Pinzas para huesos		269, 271		
STEVENS , Tijeras finas		19, 26, 48		
STILLE , Tijeras quirúrgicas		42		
- Pinzas anatomica		90		
STITCH , Tijeras finas		19		
Instrumentos para medir		4 - 5		
SWEDESH MOD. , Portaagujas		149		

T

TAKAHASHI , Pinzas para huesos		274		
TAYLOR , Pinzas quirúrgicas		102		
TENNANT , Pinzas quirúrgicas		100		
TESSIER , Osteotomos		239, 241		
THOREK , Tijeras quirúrgicas		38		
TIECK-HALLE , Espéculos nasales		200		
TOBOLD , Bejalenguas		169		
TOENNIS , Tijeras quirúrgicas		38		
TOENNIS-ADSON , Tijeras quirúrgicas		38, 64		
TROELTSH , Pinzas auriculares		105		
TUFFIER , Separadores		168		
TUOHY , Agujas para biopsia		303		

U

UNIVERSAL , Porta-algodón		161		
UNNA , cucharillos cortantes		262		

V

VANNAS , Micro Tijeras		15		
VARADY , Instrumentos para vârices		195		
VERESS , Agujas para biopsia		303		
VIDAL , Cucharillos cortantes		263		
WISE , Micro Pinzas		79		
VOLKMANN , Cucharillos cortantes		262, 265		

W

WALTER , Osteotomos		231		
WALTON , Tijeras finas		19, 34		
- Periostótomos		213		
WANGESTEEN , Pinzas quirúrgicas		102		
WARWICK-JAMES , Instrumentos para pedicure		306		
WEBSTER , Portaagujas		145		
WEIL-BLAKESLEY , Pinzas para huesos		274		
WEITLANER , Separadores		192, 193		
WERTHEIMER , Cánulas aspiradoras		293		
WEST , Osteotomos		228		
WESTCOTT , Micro Tijeras		15		
WHITEHEAD-JENNINGS , Abrebocas		165		
WIEDER , Bejalenguas		169		
WIENER , Micro Separadores		174		
WILLIGER , Cucharillos cortantes		261, 265		
- Elevadores		205		
- Martillos quirúrgicos		248		
WILMER , Tijeras finas		22		
WULLSTEIN , Separadores		192		
- Pinzas auriculares finas		158		

Y

YANCOSKIE , Separadores		190		
YANKAUER , Disecadores		206		
- Agujas para ligaduras		159		
YASARGIL , Micro Tijeras		16		

Z

ZAUFAL-JANSEN , Pinzas para huesos		273		
---	--	-----	--	--

A

ADSON , Canules aspiratrices	293
- Ecarteur	193
- Rugines	218
- Pincés chirurgiques	87, 88, 101, 104
ADSON-BROWN , Pincés chirurgiques	87, 88
ALDERDYCE , Rugines	209
ALLIS , Pincés pour saisir les tissue	110
ALM , Ecarteurs	191
Ecarteurs buccal	165 - 168
ARKANSAS , Pierres d'affutage	310
ARRUGA , Porte aiguilles	154
ASCH , Rhinologie	282
AUFRIEHT , Ecarteurs	170, 197
- Limes à os	257
AUFRIEHT-WALTER , Ecarteurs	170
AUSTIN , Pincés chirurgiques	86
AXENFELD , Ecarteurs	176
AYERS , Micro pincés	99

B

BABBUSH , Rugines	209
BABY-ADSON , Pincés hemostatiques et à ligatures	127
BABY-ALLIS , Pincés pour saisir les tissue	110
BABY-CRILE , Pincés hemostatiques	120
BABY-CRILE-WOOD , Porte aiguilles	147
BABY-METZENBAUM , Ciseaux délicate	34
BABY-MIXTER , Pincés hemostatiques et à ligatures	127
BACKHAUS , Pincés pour fixer les compresses	112
BALLENGER , Ostéotomes	225
- Bistouris	12
- Rhinologie	238
BALLENGER-HAYEK , Rugines	211
BARON , Canules aspiratrices	291
BARRAQUER , Ecarteurs	174
- Micro porte aiguilles	134, 136
- Pincés à épiler	106
BARTH , Curettes	261
BEASLEY-BACOCK , Pincés chirurgiques	87
BEAUPRE , Pincés à épiler	106
BECKMANN , Spéculums nasaux	200
BEER , Pincés à épiler	106
BELLUCCI , Canules aspiratrices	291
- Micro Pincés auriculaires	158
BENGOLEA , Pincés hemostatiques	126
BERGMANN , Maillets chirurgiques	249
BEYER , Pincés à os	273
BIEMER , Approximateurs	157
- Clamps vasculaires	155
BIEMER-MÜLLER , Approximateurs	157
BIRCHER-GANSKE , Pincés pour chirurgie osseuse	276
BIRKETT , Pincés hemostatiques	126
BIRO , Ciseaux délicate	22
BISHOP-HARMON , Micro Pincés	100
Bistouris	6 - 12
BLUMENTHAL , Pincés à os	270
BÖHLER , Pincés à os	275
BOIES , Rhinologie	283
BONN , Micro Pincés	100
BONNEY , Pincés chirurgiques	102
BOYNTON , Porte aiguilles	154
BOWMANN , Sondes	160
BRAUN , Pincés hemostatiques	114
BROCK , Micro Ciseaux	17
- Micro Pincés	81
- Micro Porte aiguilles	133
BRÜNINGS , Bistouris	12
BRUNS , Curettes tranchantes	264
BUCKLEY , Ostéotomes	224
BUNT , Pincés à stérilisation	316

C

Canules aspiratrices	287 - 302
-----------------------------	-----------

CAPLAN , Ciseaux à os	47
- Rhinologie	283
CARTER , Rugines	212
CASPAR , Manche de bistouris	9
CASTROVIEJO , Micro porte aiguilles	136, 137
- Porte aiguilles	138, 140
- Instruments à mesurer	4
CHADWICK , Ciseaux délicate	22
CHEATTLE , Pincés à stérilisation	316
CINELLI , Ciseaux délicate	34
- Rhinologie	233
COLLIN , Pincés à stérilisation	316
CONVERSE , Bistouris	11
- Ecarteurs	172
- Lime à os	254
- Porte aiguilles	145
CONWAY , Ecarteurs	179
CORN , Pincés chirurgiques	86
CORONAL , Ecarteur	190
COTTLE , Bistouris	11
- Ecarteurs	172, 175, 177, 179
- Ciseaux chirurgiques	23, 46, 64
- Limes à os	257
- Maillets chirurgiques	249
- Micro pincés	99
- Osteotomes	230, 236, 237
- Rugines	210, 211, 212
- Rhinologie	201
- Instruments à écraser le cartilage	175
COTTLE-KNAPP , Ciseaux délicate	24
COTTLE-MASING , Ciseaux délicate	22
COTTLE-NEIVERT , Ecarteurs	175
COTTLE-WALSHAM , Rhinologie	282
CRAIG , Rhinologie	283
CRILE , Pincés hemostatiques	119, 120
CRILE-MURRAY , Porte aiguilles	141
CRILE-WOOD , Porte aiguilles	141, 147, 153
Curettes	261 - 265
CUSHING , Ecarteurs	178, 181, 182
- Rugines	218
- Pincés chirurgiques	93, 102
CUSHING-KOCHER , Ecarteurs	182

D

DANDY , Pincés hemostatiques	119
DAVIS , Dissecteurs - Separateurs	206
- Pincés à stérilisation	315
DAVIS-BOYLE , Ecarteur buccal	166
DEAN , Ciseaux chirurgiques	45
DEAVER , Ciseaux chirurgiques	32
- Ecarteurs	184
DERF , Porte aiguilles	141, 145
DESMARRES , Ecarteurs	179
- Ecarteur à enduit plastique isolant	130
- Micro Pincés	99
DE BAKEY , Pincés atraumatiques	96, 97, 98
- Pincés chirurgiques	103
- Porte aiguilles	150
DE MARTEL , Pincés hemostatiques	111
DIEFFENBACH , Clamps	155
DIETRICH , Porte aiguilles	138
DINGMANN , Ecarteur buccal	167
- Pincés pour chirurgie osseuse	276
- Limes à os	256
Dissecteurs	205 - 208
Ecarteurs	172 - 197
DIXON-LOVELACE , Pincés hemostatiques	126
DUNN-DAUTREY , Ecarteurs	171
DUPLAY , Spéculums nasaux	3

E

ELSCHNIG , Pincés chirurgiques	100
EPKER , Osteotomes	235

F

FACE-LIFT , Ciseaux chirurgiques	67, 69
- Ciseaux Wellenschliff	70
FAGER , Dissecteur - Separateurs	206
FARABEUF , Ecarteurs	180
- Rugines	219
FARABEUF-COLLIN , Rugines	219
FAULKNER , Rhinologie	232
FAURE , Pincés pour fixer les compresses	112
FEICHENFELD , Pincés à échardes	106
FERGUSSON , Canules aspiratrices	290
FERRIS-SMITH-CUSHING , Pincés à os	274
FINSEN , Ecarteurs	191
FOERSTER-BALLENGER , Pincés à tampons	115
FOMON , Bistouris	11
- Ecarteurs	175
- Ciseaux chirurgiques	45, 46, 64
- Ciseaux délicate	34
- Limes à os	255, 259
- Rugines	213
- Rhinologie	233
Ciseaux	15 - 75
FOSTER-GILLIES , Porte aiguilles	144
FOX , Curettes	263
FRAZIER , Canules aspiratrices	290, 293
FREEMAN , Ecarteurs	190
- Ciseaux chirurgiques	66, 71
- Ciseaux Wellenschliff	72
FREEMAN-GORNEY , Ciseaux chirurgiques	66, 71
FREEMAN-KAYE , Ciseaux chirurgiques	66, 67, 73
FREER , Pylons - Ostéotomes	223
- Bistouris	12
- Micro Ecarteurs	175
- Rugines	209, 212, 213, 216
FRIEDMANN , Pincés à os	270, 271

G

GALLAHER , Limes à os	256
GEMINI , Pincés hémostatiques	129
GERALD , Pincés chirurgiques	95, 104
GERALD-BROWN , Pincés chirurgiques	95
GIDEF , Pincés hémostatiques délicate	118
GIESSEN , Ecarteurs	180
GILLIES , Micro ecarteurs	173
- Pincés atraumatiques	98
- Porte aiguilles	144, 148
GIUNTA-NASAL , Ciseaux Wellenschliff	70
GLASSMAN , Ciseaux chirurgiques	27
GOLDMANN , Rhinologie	283
GOLDMAN-FOX , Ciseaux chirurgiques	25, 49, 53
- Ciseaux délicate	25
GOOD , Ciseaux pour les amygdales	43
GORNEY , Canules aspiratrices	289
- Ecarteur	190
- Ciseaux chirurgiques	43, 73
- Ciseaux à os	47
- Ciseaux Wellenschliff	67, 68, 70, 72
GRAEFE , Ciseaux délicate	22
- Micro Pincés	99
- Pincés chirurgiques	86, 100
GREEN , Micro Pincés	99
GREENBERG-PAR , Ciseaux nasaux	48, 54
GREGORY , Ciseaux chirurgiques	69
GROSS , Pincés à tampons	115
GRUENWALD , Pincés auriculaires	105
GUILLIEN , Canules aspiratrices	289
GUTHRIE , Micro ecarteurs	173, 174

H

HABERER , Ecarteurs	168
HALSEY , Porte aiguilles	141, 145
HALSTED , Pincés hémostatiques	120
- Pincés hémostatiques délicate	118

HALSTED-MOSQUITO , Pincés hémostatiques	120
- Pincés hémostatiques délicate	117
HARRINGTON , Ecarteurs	185
HARTMANN , Abaisse langue	169
- Canules aspiratrices	294
- Rhinologie	198, 199
- Spéculums pour adultes	3
HARTMANN-BABY-MOSQUITO , Pincés hémostatiques	117
HEANEY(HEGAR) , Porte aiguilles	142
HEGAR , Porte aiguilles	142, 146
HEGAR-MAYO-SEELEY , Porte aiguilles	153
HEISS , Pincés hémostatiques	126
HENAHAN , Rugines	218
HEYMANN , Ciseaux chirurgiques	46
HEYMANN-KNIGHT , Ciseaux chirurgiques	45
HOUSE , Canules aspiratrices	292
- Ecarteur	178
HOWARD , Limes à os	253
HOWARTH , Rugines	211
HUNT , Micro pincés	99
HUNTER , Pincés à échardes	106

I

IRIS , Ciseaux chirurgiques	50, 53
- Ciseaux délicate	20
- Gauche Ciseaux	52
- Ciseaux Wellenschliff	65

J

JACOBSON , Curettes tranchantes	261
- Micro Ciseaux	16
- Micro porte aiguilles	135
- Porte aiguilles	139
JACOBSON-MICRO , Pincés hémostatiques délicate	111
JAEGER , Micro Ecarteurs	174
JAMESON , Ciseaux chirurgiques	23
JAMESON-WERBER , Ciseaux chirurgiques	23
JANSEN , Curettes tranchantes	261
- Pincés à os	272
- Pincés auriculaires	105
- Rugines	219
JONES , Pincés pour fixer les compresses	112, 114
JOSEPH , Bistouris	11, 12
- Ecarteurs	175
- Ciseaux chirurgiques	33, 64
- Limes à os	256
- Rugines	212, 213, 218
- Rhinologie	258

K

KAHN , Ciseaux chirurgiques	44
KAYE , Ciseaux délicate	19
KAYE-FACELIFT , Ciseaux chirurgiques	71
KELLY , Ciseaux chirurgiques	28, 54
- Pincés hémostatiques	123
KERPEL , Curettes tranchantes	263
KERSCHNER , Micro Ecarteurs	173
KEYES , Rhinologie	263
KILLIAN , Ostéotomes	225
- Canules aspiratrices	295
- Rugines	211
- Rhinologie	198, 199, 283
KILLIAN-KLAUS , Ostéotomes	225
KILNER , Ecarteurs	172
- Ciseaux chirurgiques	23, 27, 48, 54
- Ciseaux Wellenschliff	70
KILNER-DOUGHTY , Ecarteur buccal	165
KIRBY , Ecarteurs	175, 179
KLAR-EVATEUR , Ecarteurs	179
KLEINERT-KUTZ , Pincés à os	273
KNAPP , Micro ecarteurs	174
KOCHER , Ecarteurs	182
- Pincés hémostatiques	121, 123, 125

Alphabetisches Inhaltsverzeichnis	Alphabetical index	Indice alfabetico	Indice alfabetico	Index alphabétiques
KOCHER-OCHSNER , Pincés hemostátiques		122		
KÖNIG , Elevateur		205		
KRESSNER , Rhinologie		282		
KUHNT , Pincés chirurgiques		100		
L				
LA GRANGE , Ciseaux délicate		25, 49		
LAMBERT , Micro Pincés		99		
LAMBOTTE , Rugines à periostomie		242		
LANGENBECK , Rugines		209, 219		
Laryngoscopes		3		
LEMPERT , Pincés à os		271		
LERICHE , Pincés hemostátiques		119		
LEXER , Ostéotomes		245		
- Ciseaux chirurgiques		41, 62		
LEWIS , Limes à os		257		
LICHTENBERG , Porte aiguilles		154		
LIEBERMANN-TENNANT , Micro Ecarteurs		173		
Lime à os		253 - 260		
LISTER , Pincés hemostátiques		114		
LISTON , Pincés à os		275		
LITTAUER , Pincés à épiler		106		
LITTLER , Ciseaux délicate		34		
LOCKLIN , Ciseaux chirurgiques		24, 28		
LOCKLIN MOD. , Ciseaux chirurgiques		24		
LOGAN , Ecarteurs		191		
LORNA , Pincés pour fixer les compresses		113		
LOVE , Ecarteurs		178		
LUCAE , Maillets chirurgiques		248		
- Pincés auriculaires		105		
LUENEURG , Elevateur		205		
LUER , Ecarteur		178		
- Pincés à os		272		
M				
MacCOLLUM-DINGMAN , Dissecteur		189		
MAGILL , Canules aspiratrices		295		
MAIER , Pincés à tampons		116		
MALINIAC , Ecarteurs nasaux		197		
MALTZ , Bistouris		12		
- Lime à os		259		
- Rhinologie		260		
MARTINI , Curettes tranchantes		261		
Maillets chirurgiques		249 - 250		
MASING , Bistouris		12		
- Rugines		210, 212		
- Rhinologie		233		
MATHIEU , Porte aiguilles		154		
MAYO , Ciseaux chirurgiques		39, 40, 51, 63		
- Pincés à stérilisation		316		
MAYO-HEGAR , Porte aiguilles		142, 146		
MAYO-HEGAR-FINO , Porte aiguilles		147		
MAYO-HEGAR-HEANEY , Porte aiguilles		146		
MAYO-LEXER , Ciseaux chirurgiques		63		
MAYO-NOBLE , Ciseaux chirurgiques		39		
MAYO-STILLE , Ciseaux chirurgiques		42, 62		
MC DONALD , Rugines		216		
MC INDOE , Rhinologie		232		
- Pincés Atramaatiques		98		
MC INTOSH , Set Laryngoscopes		3		
MC IVOR , Ecarteur buccal		166		
MC KENTY , Rugines		211, 213		
MC PHERSON , Pincés chirurgiques		100		
MEAD , Maillets chirurgiques		248		
- Rugines		209		
- Pincés à os		270		
MEDHORN , Clamps vasculaires		155		
METZENBAUM , Ciseaux chirurgiques		33, 35, 36, 48, 50, 58		
- Ciseaux Wellenschliff		65		
METZENBAUM-FINO , Ciseaux chirurgiques		35, 36, 53, 59, 60, 61		
MICRO-HALSTED , Pincés hemostátiques délicate		117		
MICRO-IRIS , Ciseaux délicate		20		
MICRO-RYDER , Porte aiguilles		151, 152		
MICRO-VASCULAR , Porte aiguilles		150		
MILLARD , Ecarteurs		172, 190		
MILLER , Limes à os		253		
MILLIGAN , Dissecteur - Separateur		206		
MINI-FRIEDMANN , Pincés à os		269, 270		
MINI-GILLIES , Porte aiguilles		144, 148		
MINI-LAMBOTTE , Ostéotomes		229		
MINI-LEXER , Ostéotomes		244		
MINI-MALTZ , Lime à os		259		
MINI-OLSEN-HEGAR , Porte aiguilles		143		
MINI-ROUX , Ecarteurs		181		
MOD. MARTIN , Porte coton		161		
MODELL WIEN , Spéculums nasaux		200		
MOLT , Rugines		218		
MÜLLER , Approximateur		157		
N				
NEIVERT , Ecarteurs		177		
NELSON-METZENBAUM , Ciseaux chirurgiques		37		
NEWS , Ecarteur		178		
NOYES , Micro Ciseaux		15		
NUBOER , Canules aspiratrices		288		
O				
OBWEGESER , Aiguilles pour ligatures		159		
- Ecarteurs		170, 183		
- Ostéotomes		247		
- Rugines		215, 217		
O'BRIEN , Ciseaux à ligatures		74		
O'CONNOR , Micro Ecarteurs		174		
OLIVECRONA , Dissecteur - Separateur		207		
- Pincés à os		272		
OLSEN-HEGAR , Porte aiguilles		143, 149		
OMBREDANNE , Maillets chirurgiques		249		
Ostéotomes		223 - 248		
ORINGER , Ecarteur buccal		169		
OVERHOLT , Pincés hemostátiques		128		
OVERHOLT-GEISSENDORFER , Pincés hemostátiques		128		
P				
PARKER-LANGENBECK , Ecarteurs		180		
PAR-TYPE , Ciseaux nasaux		54		
PARTSCH , Ostéotomes - Scalpel		227, 228		
PAPAVERO-HARTMANN , Rhinologie		201		
PAUL , Ecarteurs		176		
PEAN , Pincés hemostátiques		121, 124		
- Pincés hemostátiques délicate		118		
PEAN-MURPHY , Pincés hemostátiques		114		
PECK-JOSEPH , Ciseaux chirurgiques		53		
PEET , Pincés hemostátiques délicate		111		
PENFIELD , Ecarteurs		208		
PENNINGTON , Rugines		211		
Rugines		209 - 219		
PERRY , Pincés chirurgiques		85		
PIERCE , Rugines		211		
Pincés hemostátiques		109 - 130		
Pincés		79 - 106		
PITANGUI , Marcateur		109		
PLESTER , Canules aspiratrices		290		
- Ecarteurs		194		
Porte Aiguilles		133 - 154		
POTTS-SMITH , Pincés chirurgiques		92, 102		
POTTS-YASARGIL , Micro Ciseaux		16		
Q				
QUINBY , Ciseaux délicate		22		
QUINKE , Aiguilles à biopsie		303		
R				
RADOLF , Pincés pour extraire les ongles		280		
RAGNELL , Ecarteurs		180		

- Micro Ciseaux délicate	19
RAGNELL-DAVIS , Ecarteurs	180
RAMPLEY , Pincés à tampons	116
RANKIN , Pincés hémostatiques	123
REYNOLDS , Ciseaux délicate	26
Rhinologie	198 - 201
ROCHESTER-PEAN , Pincés hémostatiques	122, 129
ROGER , Rugines	211
ROGGE , Pincés à stérilisation	315
ROLLET , Micro Ecarteurs	174
ROWE , Pincés à riposition	281
ROSE , Ecarteur	178
ROSTKOWSKI , Ecarteurs	179
ROUX , Ecarteurs	181
ROUX-MAGNUS , Ecarteurs	181
RUBIN , Rhinologie	234, 282
RUSKIN , Rhinologie	273
RUSKIN-LISTON , Pincés à os	275
RUSKIN-STILLE , Pincés à os	273
RYDER , Porte aiguilles	152

S

SAALFELD , Curettes tranchantes	262
SACHS , Dissecteur - Separateur	206
SALZBURG , Rugines	210
SAROT , Porte aiguilles	149
SAUG-RASPATORIUM , Canules aspiratrices	289
SCHAEDEL , Pincés pour fixer les compresses	112
SCHAEDE , Curettes tranchantes	264
SCHNEIDER , Rugines	219
SCHNEIDER-SAUERBRUCH , Rugines à périostomie	242
SCHWACKENDIEK , Ciseaux pour les amygdales	43
SCOVILLE , Ecarteurs	182
SEDILLOT , Rugines	214, 219
SEMKEN , Pincés chirurgiques	87, 92, 101
SENN-GREEN , Ecarteurs	180
SENN-MILLER , Ecarteurs	177
SEWALL , Rugines	212
SHEA , Ciseaux chirurgiques	33
SHEEHAN , Ostéotomes	226
SILVER , Rhinologie	232
SIMON , Ecarteurs	184
SPENCER , Ciseaux à ligatures	74
STACKE , Sondes	160
STEINHÄUSER , Rugines	217
STELLA , Ciseaux chirurgiques	68
STELLBRINK , Pincés à os	269, 271
STEVENS , Ciseaux délicate	19, 26, 48
STILLE , Ciseaux chirurgiques	42
- Pincés anatomiques	90
STITCH , Ciseaux délicate	19
Instruments à mesurer	4 - 5
SWEDESH MOD. , Porte aiguilles	149

T

TAKAHASHI , Pincés à os	274
TAYLOR , Pincés chirurgiques	102
TENNANT , Pincés chirurgiques	100
TESSIER , Ostéotomes	239, 241
THOREK , Ciseaux chirurgiques	38
TIECK-HALLE , Spéculums nasaux	200
TOBOLD , Abaisse langue	169
TOENNIS , Ciseaux chirurgiques	38
TOENNIS-ADSON , Ciseaux chirurgiques	38, 64
TROELTSH , Pincés auriculaires	105
TUFFIER , Ecarteurs	168
TUOHY , Aiguilles à biopsie	303

U

UNIVERSAL , Porte-coton	161
UNNA , Curettes tranchantes	262

V

VANNAS , Micro Ciseaux	15
VARADY , Stripper à anneau	195
VERESS , Aiguilles à biopsie	303
VIDAL , Curettes tranchantes	263
WISE , Micro Pincés	79
VOLKMANN , Curettes tranchantes	262, 265

W

WALTER , Ostéotomes	231
WALTON , Ciseaux délicate	19, 34
- Rugines	213
WANGESTEEN , Pincés chirurgiques	102
WARWICK-JAMES , Pincés à ongles	306
WEBSTER , Porte aiguilles	145
WEIL-BLAKESLEY , Pincés à os	274
WEITLANER , Ecarteurs	192, 193
WERTHEIMER , Canules aspiratrices	293
WEST , Ostéotomes - Scalpel	228
WESTCOTT , Micro Ciseaux	15
WHITEHEAD-JENNINGS , Ecarteur buccal	165
WIEDER , Abaisse langue	169
WIENER , Micro Ecarteurs	174
WILLIGER , Curettes tranchantes	261, 265
- Elevateur	205
- Maillets chirurgiques	248
WILMER , Ciseaux délicate	22
WULLSTEIN , Ecarteurs	192
- Micro Pincés auriculaires	158

Y

YANCOSKIE , Ecarteur	190
YANKAUER , Dissecteur	206
- Aiguilles passe-fils	159
YASARGIL , Micro ciseaux	16

Z

ZAUFAL-JANSEN , Pincés à os	273
------------------------------------	-----

Nummernverzeichnis		Alphanumerical index		Indice alfanumerico		Indice alfanumerico		Index alphanumériques	
Articolo	Pagina	Articolo	Pagina	Articolo	Pagina	Articolo	Pagina	Articolo	Pagina
712-18	212	BD-57	86	BD-124	89	BD-213	101		
		BD-58	86	BD-126	89	BD-214	101		
718-24G	209	BD-59	86	BD-127	91	BD-215	101		
		BD-60	84	BD-128	93	BD-216	101		
AA-S104	3	BD-60T	104	BD-129	93	BD-217	101		
AA-S503	3	BD-61	90	BD-130	99	BD-218	102		
		BD-62	84	BD-131	99	BD-219	102		
AB-04	3	BD-62T	104	BD-132	99	BD-220	102		
AB-05	3	BD-63	90	BD-133	93	BD-221	103		
AB-06	3	BD-64	84	BD-134	93	BD-222	103		
AB-07	3	BD-65	90	BD-135	99	BD-223	103		
AB-09	3	BD-66	84	BD-136	99	BD-224	103		
AB-32R	3	BD-67	90	BD-138	94	BD-225	103		
AB-41R	3	BD-68	84	BD-139	94	BD-226	102		
		BD-70	88	BD-140	99	BD-227	102		
BB-36	9	BD-71	88	BD-141	88	BD-228	102		
BB-46	9	BD-72	88	BD-144	91	BD-229	103		
BB-48	9	BD-73	88	BD-145	87	BD-230	101		
BB-50	9	BD-74	89	BD-146	105	BD-231	101		
BB-52	9	BD-75	89	BD-147	105	BD-232	102		
		BD-75T	104	BD-148	90	BD-233	102		
BD-04	86	BD-76	89	BD-149	94	BD-234	102		
BD-05	85	BD-78	89	BD-160	96	BD-235	79		
BD-06	85	BD-79	89	BD-160T	103	BD-236	79		
BD-07	86	BD-80	96	BD-161	96	BD-237	79		
BD-09	93	BD-80T	103	BD-161T	103	BD-238	86		
BD-09T	104	BD-81	96	BD-162	96	BD-239	86		
BD-10	89	BD-81T	103	BD-162T	103	BD-240	90		
BD-10IS	130	BD-82	96	BD-163	96	BD-241	90		
BD-14	92	BD-83	96	BD-163T	103	BD-242	90		
BD-15	92	BD-84	96	BD-164	96	BD-243	90		
BD-16	90	BD-84T	103	BD-165	97	BD-244	90		
BD-18	93	BD-85	96	BD-166	97	BD-245	90		
BD-19	93	BD-86	96	BD-167	97	BD-246	90		
BD-20	93	BD-86T	103	BD-168	97	BD-247	90		
BD-20IS	130	BD-87	96	BD-169	97	BD-248	90		
BD-21	92	BD-88	96	BD-170	97	BD-249	90		
BD-22	105	BD-89	96	BD-171	97	BD-250	101		
BD-23	89	BD-90	88	BD-172	97	BD-251	101		
BD-23IS	130	BD-91	92	BD-173	97	BD-252	102		
BD-24	89	BD-92	88	BD-174	106	BD-255	100		
BD-24IS	130	BD-93	88	BD-177	88	BD-256	100		
BD-25	89	BD-95	92	BD-178	88	BD-260	99		
BD-26	89	BD-96	86	BD-179	105	BD-261	99		
BD-30	88	BD-97	89	BD-180	93	BD-263	99		
BD-30T	104	BD-98	89	BD-181	93	BD-271	91		
BD-31	88	BD-99	89	BD-182	93	BD-272	91		
BD-31T	104	BD-100	89	BD-183	93	BD-273	91		
BD-32	85	BD-101	105	BD-186	98	BD-273IS	130		
BD-33	85	BD-102	105	BD-190	98	BD-274	91		
BD-34	85	BD-104	93	BD-191	98	BD-275	91		
BD-35	85	BD-105	89	BD-192	98	BD-276	91		
BD-36	85	BD-106	94	BD-193	105	BD-277	91		
BD-38	93	BD-107	94	BD-194	86	BD-277IS	130		
BD-39	93	BD-108	94	BD-194IS	130	BD-278	91		
BD-40	85	BD-109	91	BD-195	86	BD-279	98		
BD-41	85	BD-110	91	BD-196	86	BD-280	98		
BD-42	85	BD-111	91	BD-200	84	BD-281	92		
BD-42T	104	BD-112	91	BD-201	84	BD-282	92		
BD-43	85	BD-113	91	BD-202	84	BD-287	92		
BD-43T	104	BD-114	91	BD-203	84	BD-288	92		
BD-44	87	BD-115	94	BD-205	84	BD-289	92		
BD-45	87	BD-116	94	BD-206	84	BD-290	92		
BD-46	87	BD-117	94	BD-207	87	BD-291	92		
BD-47	87	BD-118	94	BD-208	87	BD-292	92		
BD-51	87	BD-119	94	BD-209	87	BD-300	101		
BD-53	92	BD-120	106	BD-210	101	BD-333	99		
BD-54	92	BD-122	106	BD-211	101	BD-334	99		
BD-56	86	BD-123	106	BD-212	101	BD-342	172		

Nummernverzeichnis		Alphanumerical index		Indice alfanumerico		Indice alfanumerico		Index alphanumériques	
Articolo	Pagina	Articolo	Pagina	Articolo	Pagina	Articolo	Pagina	Articolo	Pagina
BD-343	172	BS-28	312	BT-160	184	BT-401	181		
		BS-30	312	BT-162	184	BT-402	181		
BF-01	116	BS-40	312	BT-163	184	BT-403	181		
BF-02	116	BS-41	312	BT-167	184	BT-404	181		
BF-05	116	BS-42	312	BT-190	177	BT-405	181		
BF-06	116	BS-43	313	BT-191	177	BT-406	181		
BF-07	116	BS-59	313	BT-192	177	BT-490	130		
BF-08	116	BS-60	313	BT-193	177	BT-491	130		
BF-11	115	BS-61	313	BT-194	177	BT-492	130		
BF-13	115			BT-195	177	BT-493	130		
BF-14	115	BT-05	218	BT-196	172	BT-500	186		
BF-15	115	BT-06	218	BT-197	172	BT-501	186		
BF-20	114	BT-07	218	BT-198	172	BT-501R	186		
BF-24	114	BT-09	179	BT-199	172	BT-502	186		
BF-26	114	BT-15	173	BT-200	175	BT-502R	186		
BF-30	116	BT-16	173	BT-203	173	BT-503	187		
BF-31	116	BT-18	177	BT-204	173	BT-503R	187		
BF-38	112	BT-19	177	BT-207	173	BT-504	187		
BF-40	112	BT-20	180	BT-208	173	BT-504R	187		
BF-41	112	BT-22	172	BT-210	175				
BF-42	112	BT-25	180	BT-211	175	BV-07	192		
BF-43	112	BT-26	180	BT-212	175	BV-08	191		
BF-44	112	BT-27	180	BT-213	175	BV-09	192		
BF-45	112	BT-28	179	BT-214	175	BV-10	191		
BF-46	112	BT-37	214	BT-215	175	BV-12	191		
BF-48	112	BT-38	177	BT-216	175	BV-20	193		
BF-50	113	BT-39	177	BT-217	175	BV-21	193		
BF-52	113	BT-40	177	BT-218	175	BV-22	193		
BF-58	114	BT-41	177	BT-226	172	BV-23	193		
BF-74	113	BT-42	177	BT-228	184	BV-36	191		
BF-75	113	BT-44	177	BT-229	184	BV-37	191		
BF-76	113	BT-45	177	BT-230	174	BV-38	191		
BF-77	113	BT-46	177	BT-231	174	BV-39	191		
BF-78	115	BT-48	180	BT-232	174	BV-45	191		
BF-79	115	BT-49	180	BT-233	174	BV-47	191		
BF-94	115	BT-50	176	BT-234	174	BV-48	191		
BF-95	115	BT-51	176	BT-235	174	BV-49	191		
		BT-52	176	BT-236	174	BV-51	191		
BM-01	149	BT-54	176	BT-237	174	BV-68	193		
BM-02	149	BT-55	176	BT-238	176	BV-70	193		
BM-03	149	BT-56	176	BT-239	176	BV-90	194		
BM-04	149	BT-57	175	BT-240	176	BV-91	194		
BM-28	159	BT-70	179	BT-241	176	BV-92	194		
BM-61	143	BT-71	179	BT-242	176	BV-93	194		
BM-62	143	BT-72	179	BT-243	175	BV-111	192		
BM-63	143	BT-73	179	BT-244	179	BV-112	192		
BM-64	143	BT-74	179	BT-245	179				
BM-74	159	BT-75	179	BT-273	172	CH-11	216		
BM-87	155	BT-76	179	BT-282	181	CH-12	216		
BM-88	155	BT-77	179	BT-283	181	CH-13	216		
BM-89	155	BT-79	179	BT-284	181	CH-14	216		
BM-90	155	BT-92	183	BT-285	181				
BM-96	155	BT-93	183	BT-286	181	CS-01	311		
BM-97	155	BT-94	183	BT-287	181	CS-02	311		
BM-98	155	BT-95	183	BT-288	181	CS-03	311		
BM-99	155	BT-96	183	BT-289	181	CS-04	311		
BM-100	155	BT-100	183	BT-291	180	CS-05	311		
BM-101	155	BT-113	182	BT-296	178	CS-06	311		
BM-140	155	BT-114	182	BT-297	178	CS-32	313		
BM-141	155	BT-115	182	BT-298	178	CS-33	313		
BM-142	155	BT-116	182	BT-299	178	CS-34	313		
BM-151	159	BT-117	182	BT-312	182	CS-51	311		
		BT-118	182	BT-341	185	CS-52	311		
BR-20	311	BT-152	183	BT-342	185	CS-55	311		
BR-25	311	BT-153	183	BT-381	170	CS-80	311		
BR-28	311	BT-154	183	BT-382	177	CS-81	311		
		BT-155	183	BT-383	177	CS-82	311		
BS-23	312	BT-156	183	BT-387	170	CS-83	311		
BS-27	312	BT-157	183	BT-388	170				

Nummernverzeichnis		Alphanumerical index		Indice alfanumerico		Indice alfanumerico		Index alphanumériques	
Articolo	Pagina	Articolo	Pagina	Articolo	Pagina	Articolo	Pagina	Articolo	Pagina
DA-07	86	DO-74	258	DO-178	257	DS-33	263		
		DO-75	257	DO-179	259			ES-01	302
DB-1L	309	DO-76	257	DO-180	235	ES-03	302	ES-05	296
DB-4	310	DO-79	259	DO-181	235	ES-06	296	ES-07	296
DB-6A	310	DO-80	259	DO-182	235	ES-08	296	ES-09	296
DB-22A	310	DO-81	259	DO-183	235	ES-14	266	ES-15	266
DB-50M	309	DO-82	259	DO-184	235	ES-16	266	ES-17	266
DB-86	158	DO-83	259	DO-185	235	ES-18	266	ES-19	266
DB-91	158	DO-84	234	DO-189	258	ES-34	296	ES-35	296
DB-93	158	DO-85	234	DO-190	240	ES-36	296	ES-39	301
DB-96	310	DO-87	258	DO-191	240	ES-41	297	ES-45	106
DB-101	274	DO-91	225	DO-192	240	ES-46	106	ES-48	106
DB-102	274	DO-92	225	DO-193	240	ES-49	301	ES-50	301
DB-106	158	DO-94	171	DO-194	240	ES-51	297	ES-52	297
DB-205	158	DO-95	171	DO-195	240	ES-53	297	ES-54	297
DB-215	158	DO-96	171	DO-196	240	ES-55	297	ES-56	297
DB-299	310	DO-97	171	DO-197	240	ES-57	297	ES-58	297
DB-OL	310	DO-101	217	DO-200	197	ES-59	297	ES-59	297
DB-OLR	309	DO-102	217	DO-211	212	ES-60	298	ES-61	298
		DO-103	217	DO-213	178	ES-62	298	ES-62	298
DL-20	306	DO-106	217	DO-214	178	ES-63	299	ES-63	299
		DO-107	217	DO-215	178	ES-64	106	ES-64	106
DEAN	45	DO-109	258	DO-216	232	ES-65	106	ES-65	106
		DO-111	210	DO-217	232	ES-66	299	ES-66	299
DO-1	253	DO-118	234	DO-218	232	ES-67	299	ES-67	299
DO-2	253	DO-119	234	DO-225	236	ES-68	298	ES-68	298
DO-3	253	DO-125	214	DO-226	236	ES-69	298	ES-69	298
DO-4	253	DO-126	214	DO-227	236	ES-70	298	ES-70	298
DO-5	253	DO-130	230	DO-240	210	ES-71	298	ES-71	298
DO-08	169	DO-131	230	DO-241	210	ES-72	300	ES-72	300
DO-09	169	DO-132	230	DO-244	210	ES-73	300	ES-73	300
DO-10	281	DO-133	230	DO-245	256	ES-74	300	ES-74	300
DO-11	281	DO-138	217	DO-246	256	ES-75	300	ES-75	300
DO-12	281	DO-139	217	DO-259	172	ES-76	299	ES-76	299
DO-13	281	DO-140	230	DO-264	172	ES-77	298	ES-77	298
DO-14	281	DO-141	230	DO-288	283	ES-78	300	ES-78	300
DO-15	281	DO-142	170	DO-289	283	ES-79	299	ES-79	299
DO-20	233	DO-143	230	DO-292	213	ES-80	300	ES-80	300
DO-21	233	DO-144	225	DO-293	213	ES-81	299	ES-81	299
DO-22	233	DO-145	225	DO-294	213	ES-82	298	ES-82	298
DO-23	233	DO-146	225	DO-295	213	ES-83	299	ES-83	299
DO-24	233	DO-147	282	DO-296	213	ES-84	299	ES-84	299
DO-25	233	DO-148	282	DO-301	260	ES-85	299	ES-85	299
DO-26	233	DO-149	282	DO-302	260	ES-92	301	ES-92	301
DO-27	233	DO-150	236	DO-303	260	ES-102	301	ES-102	301
DO-30	159	DO-151	237	DO-304	260	ES-111	302	ES-111	302
DO-31	159	DO-152	237	DO-305	260	ES-112	302	ES-112	302
DO-34	232	DO-153	237	DO-312	260	ES-120	190	ES-120	190
DO-35	232	DO-154	237	DO-315	260	ES-121	190	ES-121	190
DO-36	232	DO-155	237	DO-401	197	ES-122	190	ES-122	190
DO-40	170	DO-156	237			ES-123	190	ES-123	190
DO-41	170	DO-157	282	DP-09	280, 306	ES-124	190	ES-124	190
DO-47	210	DO-158	236	DP-90	278				
DO-48	197	DO-159	233	DP-120	278				
DO-50	238	DO-160	231						
DO-51	238	DO-161	231	DR-40	111				
DO-52	238	DO-162	231						
DO-53	238	DO-163	231	DS-15	178				
DO-54	238	DO-164	231	DS-16	178				
DO-55	238	DO-165	231	DS-19	178				
DO-59	215	DO-166	231	DS-20	178				
DO-60	210	DO-167	231	DS-25	263				
DO-63	215	DO-168	255	DS-26	262				
DO-65	215	DO-169	255	DS-27	262				
DO-67	215	DO-170	234	DS-28	262				
DO-70	257	DO-171	234	DS-29	262				
DO-71	257	DO-172	234	DS-30	263				
DO-72	258	DO-173	232	DS-31	263				
DO-73	258	DO-177	259	DS-32	263				

Nummernverzeichnis		Alphanumerical index		Indice alfanumerico		Indice alfanumerico		Index alphanumériques	
Articolo	Pagina	Articolo	Pagina	Articolo	Pagina	Articolo	Pagina	Articolo	Pagina
ES-125	190	FD-105	134	FE-30	156	FG-41	45		
ES-126	190	FD-106	134	FE-31	156	FG-43	34		
ES-127	190	FD-107	134	FE-32	156	FG-44	34		
ES-128	190	FD-108	134	FE-33	156	FG-45	38		
ES-131	188	FD-113	134	FE-34	156	FG-46	38		
ES-132	188	FD-114	134	FE-35	156	FG-47	32		
ES-133	188	FD-115	134	FE-36	156	FG-48	32		
ES-134	188	FD-116	134	FE-37	156	FG-49	32		
ES-135	188	FD-117	106	FE-38	156	FG-50	26		
ES-140	189	FD-128	138	FE-39	156	FG-51	26		
ES-141	189	FD-137	16	FE-40	156	FG-52	26		
ES-142	189	FD-138	16	FE-41	156	FG-53	26		
ES-143	188	FD-148	139	FE-42	156	FG-54	26		
ES-145	188	FD-149	139	FE-43	156	FG-55	26		
ES-150	195	FD-152	136	FE-44	156	FG-56	26		
ES-151	195	FD-153	136	FE-45	156	FG-57	26		
ES-152	195	FD-172	140	FE-46	156	FG-58	23		
ES-153	195	FD-173	140	FE-47	156	FG-59	23		
ES-200	109	FD-186	16	FE-48	156	FG-60	38		
ES-201	109	FD-187	16	FE-49	156	FG-61	38		
ES-202	109	FD-191	16	FE-50	156	FG-63	64		
		FD-201	81	FE-51	156	FG-64	64		
FB-107	195	FD-202	81	FE-52	156	FG-65	38		
FB-108	195	FD-203	81, 133	FE-53	156	FG-66	27		
FB-109	195	FD-204	81, 133	FE-54	156	FG-67	27		
FB-120	111	FD-211	133	FE-55	156	FG-68	27		
FB-390	196	FD-213	133	FE-56	156	FG-69	27		
FB-392	196	FD-218	139	FE-57	156	FG-73	38		
FB-394	196	FD-219	139	FE-58	156	FG-74	38		
FB-395	196	FD-221	17	FE-59	156	FG-75	38		
FB-396	196	FD-223	17	FE-60	156	FG-90	33		
FB-397	196	FD-246	135			FG-91	33		
FB-398	196	FD-247	135	FF-70	274	FG-92	53		
FB-400	196	FD-248	135			FG-93	34		
		FD-249	135	FG-1	20	FG-94	22		
FD-06	15	FD-306	17	FG-1SC	50	FG-95	34		
FD-08	15	FD-307	17	FG-1TC	53	FG-98	53		
FD-10	15	FD-310	17	FG-2	20	FG-99	45		
FD-12	15	FD-311	17	FG-2SC	50	FG-100	34		
FD-13	15	FD-500	155	FG-2TC	53	FG-101	21		
FD-14	136	FD-501	155	FG-3	22	FG-102	21		
FD-16	136	FD-502	155	FG-4	20	FG-103	21		
FD-17	136	FD-503	155	FG-5	20	FG-104	20		
FD-18	136	FD-504	155	FG-6C	27	FG-105	21		
FD-19	136	FD-505	155	FG-6R	27	FG-108	22		
FD-20	136	FD-506	155	FG-7	46	FG-109	22		
FD-21	137	FD-507	157	FG-8	46	FG-110	47		
FD-22	137	FD-508	157	FG-9	46	FG-112	24		
FD-23	137	FD-509	157	FG-10	43	FG-113	24		
FD-24	134	FD-510	157	FG-11L	52	FG-116	44		
FD-25	137	FD-511	157	FG-12L	52	FG-117	32		
FD-27	138	FD-512	157	FG-13	20	FG-122	22		
FD-28	137	FD-513	157	FG-14	36	FG-123	23		
FD-29	137	FD-514	157	FG-15	20	FG-124	23		
FD-30	139	FD-515	157	FG-16	32	FG-125	43		
FD-31	140	FD-517	157	FG-17	32	FG-126	43		
FD-32	139	FD-518	157	FG-18	32	FG-127	43		
FD-33	138	FD-519	157	FG-19C	27	FG-128	43		
FD-34	140	FD-520	157	FG-19R	27	FG-135	43		
FD-35	138			FG-21	23	FG-136	43		
FD-36	140	FE-21	156	FG-22	23	FG-146	34		
FD-37	140	FE-22	156	FG-23	21	FG-147	33		
FD-39	138	FE-23	156	FG-24	21	FG-148	33		
FD-45	15	FE-24	156	FG-28	36	FG-151	74		
FD-46	15	FE-25	156	FG-30	22	FG-153	64		
FD-63	135	FE-26	156	FG-36	23	FG-154	64		
FD-79	15	FE-27	156	FG-37	23	FG-156	24		
FD-80	15	FE-28	156	FG-38	22	FG-157	24		
FD-81	15	FE-29	156	FG-39	22	FG-158	24		

Nummernverzeichnis		Alphanumerical index		Indice alfanumerico		Indice alfanumerico		Index alphanumériques	
Articolo	Pagina	Articolo	Pagina	Articolo	Pagina	Articolo	Pagina	Articolo	Pagina
FG-159	24	FK-110	264	FL-23	227	FL-267	229		
FG-165	64	FK-111	264	FL-24	227	FL-268	229		
FG-166	64	FK-112	264	FL-32	229	FL-269	229		
FG-167	53	FK-113	264	FL-40	227	FL-272	245		
FG-168	53	FK-114	264	FL-53	229	FL-280	246		
FG-182	44	FK-115	264	FL-54	229	FL-281	246		
FG-183	44	FK-116	264	FL-58	229	FL-282	246		
FG-184	44	FK-120	264	FL-59	244	FL-283	246		
FG-185	44	FK-121	264	FL-60	244	FL-307	241		
FG-186	44	FK-122	264	FL-61	244	FL-308	241		
FG-187	44	FK-123	264	FL-62	244	FL-309	241		
FG-200	18	FK-124	264	FL-104	249	FL-310	241		
FG-201	18	FK-125	264	FL-105	249	FL-311	241		
FG-202	18	FK-126	264	FL-108	249	FL-312	241		
FG-203	18	FK-136	263	FL-114	227	FL-334	247		
FG-204	18	FK-137	263	FL-115	227	FL-335	247		
FG-205	18	FK-138	263	FL-116	227	FL-336	247		
FG-206	18	FK-139	263	FL-118	227	FL-337	247		
FG-207	18	FK-174	254	FL-126	227	FL-380	226		
FG-208	18	FK-175	255	FL-127	227	FL-381	226		
FG-209	19	FK-177	262	FL-132	227	FL-382	226		
FG-210	19	FK-178	262	FL-133	228	FL-383	226		
FG-211	19	FK-193	256	FL-134	228	FL-384	226		
FG-212	19	FK-194	256	FL-135	227	FL-385	226		
FG-215	19	FK-195	256	FL-136	227	FL-386	226		
FG-216	19	FK-196	256	FL-138	227	FL-387	226		
FG-217	19	FK-197	265	FL-141	224	FL-388	226		
FG-218	19	FK-198	265	FL-142	224	FL-401	239		
FG-219	19	FK-230	243	FL-143	224	FL-402	239		
		FK-232	243	FL-144	224	FL-403	239		
FK-1	28	FK-234	243	FL-150	263	FL-404	239		
FK-1TC	54	FK-247	219	FL-151	263	FL-405	239		
FK-2	28	FK-248	219	FL-152	263	FL-410	239		
FK-2TC	54	FK-249	219	FL-153	263	FL-411	239		
FK-10	28	FK-250	219	FL-154	263	FL-412	239		
FK-12	209	FK-251	219	FL-155	263				
FK-15	242	FK-252	218	FL-156	263	FM-1	35		
FK-16	242	FK-253	219	FL-157	263	FM-1F	35		
FK-17	242	FK-254	219	FL-158	263	FM-1SC	50		
FK-60	265	FK-255	219	FL-159	263	FM-2	35		
FK-61	265	FK-256	219	FL-177	228	FM-2F	35		
FK-62	265	FK-257	219	FL-179	228	FM-2SC	50		
FK-63	265	FK-258	219	FL-181	228	FM-3	35		
FK-64	265	FK-259	242	FL-185	228	FM-3F	35		
FK-65	265	FK-260	218	FL-186	228	FM-3SC	50		
FK-66	265	FK-261	218	FL-187	228	FM-4	35		
FK-67	265	FK-262	218	FL-210	245	FM-4F	35		
FK-68	265	FK-263	218	FL-211	245	FM-4SC	50		
FK-69	265	FK-264	213	FL-212	245	FM-5	39		
FK-70	261	FK-265	213	FL-213	245	FM-5SC	51		
FK-71	261			FL-214	245	FM-6	39		
FK-72	262	FL-01	248	FL-215	245	FM-6SC	51		
FK-73	262	FL-02	248	FL-216	245	FM-7	31		
FK-74	262	FL-03	227	FL-220	245	FM-7L	52		
FK-75	261	FL-04	227	FL-221	245	FM-8	31		
FK-76	261	FL-05	227	FL-222	245	FM-8L	52		
FK-77	261	FL-09	248	FL-223	245	FM-9	29		
FK-78	261	FL-09R	248	FL-224	245	FM-9L	52		
FK-79	262	FL-10M	248	FL-225	245	FM-10	29		
FK-80	218	FL-11	248	FL-226	245	FM-10L	52		
FK-82	212, 218	FL-11R	248	FL-230	244	FM-11	37		
FK-83	261	FL-12	248	FL-231	244	FM-12	33		
FK-84	261	FL-12R	248	FL-232	244	FM-13	37		
FK-87	28	FL-13	227	FL-233	244	FM-24	39		
FK-88	28	FL-14	227	FL-234	244	FM-24SC	51		
FK-96	254	FL-15	227	FL-263	229	FM-25	39		
FK-97	254	FL-16	229	FL-264	229	FM-25SC	51		
FK-98	254	FL-17	229	FL-265	229	FM-27	30		
FK-99	254	FL-18	229	FL-266	229	FM-28	30		

Nummernverzeichnis		Alphanumerical index		Indice alfanumerico		Indice alfanumerico		Index alphanumériques	
Articolo	Pagina	Articolo	Pagina	Articolo	Pagina	Articolo	Pagina	Articolo	Pagina
FM-29	30	FM-98	61	FM-300	48	FO-146	275		
FM-29L	52	FM-99	61	FM-301	48	FO-156	273		
FM-29SC	51	FM-100	65	FM-305	70	FO-157	273		
FM-30	30	FM-102	65	FM-306	71	FO-159	280		
FM-30L	52	FM-104	65	FM-307	71	FO-180	274		
FM-30SC	51	FM-109	33	FM-310	71	FO-190	47		
FM-31	30	FM-110	42	FM-311	66	FO-218	276		
FM-32	30	FM-111	42	FM-312	67	FO-219	276		
FM-33	30	FM-112	37	FM-316	54	FO-220	269		
FM-34	30	FM-113	37	FM-317	54	FO-299	280		
FM-35	29	FM-114	37	FM-320	68	FO-300	280		
FM-36	29	FM-115	37	FM-321	68	FO-490	283		
FM-37	29	FM-116	37	FM-323	68				
FM-38	29	FM-117	37	FM-324	73	FR-10	205		
FM-39	29	FM-118	54	FM-325	66	FR-11	12		
FM-40	29	FM-119	54	FM-326	66	FR-12	11		
FM-41	31	FM-120	36	FM-328	72	FR-15	209		
FM-42	31	FM-121	36	FM-329	72	FR-18	12		
FM-43	31	FM-122	36	FM-330	71	FR-19	12		
FM-44	31	FM-126	33	FM-331	72	FR-48	11		
FM-45	31	FM-127	33	FM-334	66	FR-49	12		
FM-46	31	FM-130	62	FM-335	67	FR-64	213		
FM-47	34	FM-131	62	FM-336	73	FR-65	213		
FM-48	34	FM-132	62	FM-337	73	FR-66	212		
FM-49	30	FM-133	62	FM-338	67	FR-67	212		
FM-50	55	FM-134	62	FM-339	69	FR-100	216		
FM-51	55	FM-135	62	FM-340	69	FR-166	216		
FM-52	55	FM-136	62	FM-341	68	FR-167	216		
FM-53	55	FM-137	62	FM-342	69	FR-168	12		
FM-54	56	FM-139	63	FM-343	70	FR-169	12		
FM-55	56	FM-140	63	FM-344	70	FR-175	12		
FM-56	56	FM-141	63	FM-350	54	FR-176	11		
FM-57	56	FM-142	63	FM-351	70	FR-177	12		
FM-58	57	FM-143	63						
FM-59	57	FM-145	57	FO-15	270	FREER	209		
FM-60	57	FM-146	57	FO-16	271				
FM-61	57	FM-147	57	FO-17	270	GF-20	288		
FM-62	30	FM-148	55	FO-18	272	GF-40	303		
FM-63	30	FM-149	55	FO-19	270	GF-41	293		
FM-66	58	FM-150	55	FO-20	273	GF-42	293		
FM-67	58	FM-151	56	FO-21	270	GF-43	291		
FM-68	58	FM-152	56	FO-22	269	GF-45	291		
FM-69	58	FM-153	56	FO-23	269	GF-47	291		
FM-70	36	FM-160	58	FO-24	269	GF-48	289		
FM-71	36	FM-161	58	FO-25	271	GF-49	289		
FM-72	31	FM-162	58	FO-34	273	GF-50	289		
FM-73	31	FM-163	58	FO-35	273	GF-53	292		
FM-74	36	FM-180	41	FO-37	272	GF-55	292		
FM-75	36	FM-181	41	FO-39	272	GF-56	292		
FM-76	42	FM-188	39	FO-43	271	GF-57	292		
FM-77	42	FM-189	39	FO-45	272	GF-58	292		
FM-78	42	FM-201	59	FO-47	276	GF-59	292		
FM-79	42	FM-202	60	FO-58	275	GF-60	293		
FM-80	40	FM-203	59	FO-59	275	GF-61	293		
FM-81	40	FM-204	60	FO-60	275	GF-63	291		
FM-82	40	FM-205	59	FO-61	275	GF-65	291		
FM-83	40	FM-206	60	FO-63	47	GF-67	291		
FM-84	40	FM-207	59	FO-87	271	GF-69	293		
FM-85	40	FM-208	60	FO-88	269	GF-70	293		
FM-86	41	FM-209	59	FO-89	269	GF-71	289		
FM-87	41	FM-210	60	FO-108	275	GF-72	289		
FM-88	41	FM-211	59	FO-130	276	GF-73	289		
FM-89	41	FM-212	60	FO-131	276	GF-74	289		
FM-90	61	FM-294	48	FO-138	273	GF-75	287		
FM-91	61	FM-295	48	FO-139	273	GF-76	287		
FM-92	61	FM-296	48	FO-141	282	GF-77	287		
FM-94	61	FM-297	48	FO-142	282	GF-85	295		
FM-96	53, 61	FM-298	48	FO-143	283	GF-86	295		
FM-97	61	FM-299	48	FO-144	47, 283	GF-87	295		

Nummernverzeichnis		Alphanumerical index		Indice alfanumerico		Indice alfanumerico		Index alphanumériques	
Articolo	Pagina	Articolo	Pagina	Articolo	Pagina	Articolo	Pagina	Articolo	Pagina
GF-88	295	GS-21	304	KO-71	213	MF-102T	104		
GF-89	303	GS-22	306	KO-72	213	MF-103	95		
GF-90	303	GS-23	75			MF-104	95		
GF-92	294	GS-24	75	LB-10	7	MF-105	95		
GF-93	294	GS-25	75	LB-11	7	MF-110	80		
GF-94	294	GS-26	75	LB-12	7	MF-111	80		
GF-96	294	GS-27	75	LB-13	7	MF-112	80		
GF-97	294	GS-28	75	LB-15	7	MF-113	80		
GF-98	288	GS-29	75	LB-20	8	MF-114	80		
GF-99	288	GS-30	316	LB-21	8	MF-115	80		
GF-100	295	GS-32	305	LB-22	8	MF-124	82		
GF-101	295	GS-34	305	LB-23	8	MF-125	82		
GF-102	295	GS-35	305	LB-25	8	MF-126	82		
GF-103	295	GS-36	305	LB-40	10	MF-127	82		
GF-104	288	GS-37	305	LB-361	9	MF-128	82		
GF-110	288	GS-38	305	LB-362	9	MF-129	82		
GF-111	294	GS-40	306	LB-363	9	MF-142T	82		
GF-112	294	GS-41	304	LB-364	9	MF-143T	82		
GF-113	294	GS-42	304	LB-365	9	MF-148	82		
GF-140	290	GS-43	304	LB-366	9	MF-149	82		
GF-141	290	GS-44	304	LB-367	9	MF-150	100		
GF-142	290	GS-45	304	LB-368	9	MF-175	100		
GF-143	290	GS-46	305	LB-369	9	MF-176	100		
GF-144	290	GS-48	305			MF-177	100		
GF-150	290	GS-50	306	LG-1	25	MF-178	100		
GF-151	290			LG-1SC	49	MF-179	100		
GF-152	290	KO-1	205	LG-2SC	49	MF-180	100		
GF-153	290	KO-2	205			MF-181	100		
GF-154	290	KO-11	211	LK-1	24	MF-182	100		
GF-188	303	KO-12	211	LK-2	28	MF-230	100		
GF-200	303	KO-13	211	LK-3	24	MF-235	100		
GF-232	291	KO-14	207	LK-4	28	MF-342T	82		
GF-240	290	KO-15	207			MF-343T	82		
GF-241	290	KO-16	207	LS-04	5	MF-354T	83		
GF-242	290	KO-17	207	LS-06	5	MF-355T	83		
GF-243	290	KO-18	206	LS-07	5	MF-356T	83		
GF-244	290	KO-19	206	LS-08	5	MF-357T	83		
GF-256	295	KO-20	209	LS-09	5	MF-358T	83		
GF-257	295	KO-21	206			MF-359T	83		
		KO-24	206	LX-102	277	MF-362T	83		
GFC	25	KO-25	206	LX-103	277	MF-363T	83		
GFC-S	21	KO-26	206	LX-109	275	MF-364T	83		
GFC-SC	49	KO-27	206	LX-125	278	MF-365T	83		
GFC-TC	53	KO-28	206	LX-138	279				
		KO-29	206	LX-139	279	MO-15	218		
GFR	25	KO-30	211	LX-140	279				
GFR-S	21	KO-38	216	LX-141	279	NK-1	9		
GFR-SC	49	KO-39	209			NK-2	9		
GFR-TC	53	KO-40	208	MA-B1	6	NK-12	10		
		KO-41	208	MA-B2	7	NK-80	174		
GFS	25	KO-42	208	MA-B3	6	NK-82	174		
GFS-SC	49	KO-43	208	MA-B3M	6	NK-83	174		
		KO-44	208	MA-B4	8	NK-84	174		
GS-01	316	KO-46	211	MA-B7	6	NK-86	174		
GS-02	315	KO-47	207	MA-B7K	6	NK-100	11		
GS-03	315	KO-48	207	MA-B8	7	NK-101	11		
GS-04	315	KO-49	207	MA-B9	7	NK-102	11		
GS-05	316	KO-50	207	MA-B10	8	NK-144	179		
GS-06	315	KO-54	206			NK-145	179		
GS-07	316	KO-61	211	MEAD	209	NK-251	180		
GS-09	316	KO-62	211			NK-420	173		
GS-10	315	KO-63	211	MF-04	79	NK-421	173		
GS-11	315	KO-64	211	MF-81	79	NK-422	173		
GS-13	316	KO-65	211	MF-82	79	NK-430	11		
GS-14	316	KO-66	211	MF-93	79	NK-431	11		
GS-16	10	KO-67	212	MF-94	79	NK-432	11		
GS-18	10	KO-68	212	MF-101	95	NK-433	11		
GS-19	306	KO-69	212	MF-101T	104				
GS-20	305	KO-70	213	MF-102	95	OL-01	302		

Nummernverzeichnis		Alphanumerical index		Indice alfanumerico		Indice alfanumerico		Index alphanumériques	
Articolo	Pagina	Articolo	Pagina	Articolo	Pagina	Articolo	Pagina	Articolo	Pagina
OL-02	302	OM-145	166	P-66	126	P-200	126		
OL-03	302	OM-146	166	P-67	126	P-205	126		
OL-04	302	OM-160	165	P-68	118	P-206	126		
OL-05	302	OM-161	165	P-69	118	P-207	111		
OL-41	303	OM-162	165	P-70	125	P-208	126		
OL-42	303	OM-163	165	P-71	125	P-209	126		
OL-43	303	OM-164	165	P-72	125	P-210	129		
OL-44	303	OM-170	166	P-73	125	P-215	129		
OL-45	303	OM-171	166	P-74	125	P-216	129		
OL-46	303	OM-172	166	P-75	125	P-217	129		
OL-47	303	OM-173	166	P-76	125	P-221	122		
OL-48	303	OM-174	166	P-77	125	P-230	120		
OL-49	303			P-79	123	P-231	120		
		OR-11	4	P-81	119	P-232	120		
OM-06	169	OR-13	4	P-82	119	P-233	120		
OM-08	169	OR-15	4	P-84	123	P-234	120		
OM-20	198	OR-17	4	P-85	123	P-235	120		
OM-21	198	OR-19	4	P-86	119	P-236	120		
OM-22	198	OR-40	5	P-87	119	P-237	120		
OM-23	198	OR-45	5	P-89	123	P-238	120		
OM-24	198			P-91	118	P-239	120		
OM-25	201	P-08	114	P-92	118	P-240	120		
OM-26	198	P-09	114	P-93	118	P-241	120		
OM-27	201	P-15	127	P-94	118	P-242	120		
OM-28	201	P-16	119	P-95	117	P-243	120		
OM-29	201	P-17	118	P-96	117	P-244	120		
OM-31	198	P-18	122	P-97	117	P-245	120		
OM-32	199	P-19	122	P-98	117	P-246	123		
OM-34	199	P-20	124	P-100	110	P-247	123		
OM-36	199	P-21	124	P-101	117	P-248	126		
OM-38	199	P-22	124	P-102	117	P-249	126		
OM-39	201	P-23	124	P-115	110	P-250	121		
OM-48	200	P-24	124	P-118	110	P-251	121		
OM-49	200	P-25	124	P-119	110	P-252	121		
OM-51	200	P-26	124	P-120	117	P-253	121		
OM-53	200	P-28	122	P-121	117	P-254	121		
OM-54	200	P-29	122	P-122	119	P-255	121		
OM-56	200	P-30	124	P-132	110	P-256	121		
OM-57	200	P-31	124	P-133	110	P-257	121		
OM-59	200	P-32	124	P-134	110	P-258	121		
OM-74	169	P-33	124	P-135	117	P-259	121		
OM-75	169	P-34	124	P-136	127	P-260	121		
OM-76	169	P-35	124	P-137	127	P-261	121		
OM-77	169	P-36	124	P-138	127	P-262	121		
OM-80	168	P-38	122	P-139	127	P-263	121		
OM-81	168	P-39	122	P-142	128	P-266	111		
OM-82	168	P-40	125	P-143	128	P-267	111		
OM-85	168	P-41	125	P-144	128				
OM-87	168	P-42	125	P-145	128	PF-7	160		
OM-88	168	P-43	125	P-146	128	PF-14	160		
OM-99	168	P-44	125	P-147	128	PF-15	160		
OM-101	168	P-45	125	P-148	128	PF-20	160		
OM-102	168	P-46	125	P-160	128	PF-21	160		
OM-103	168	P-47	125	P-161	128	PF-22	160		
OM-104	168	P-49	123	P-162	128	PF-23	160		
OM-110	167	P-50	110	P-163	128	PF-25	160		
OM-111	167	P-51	110	P-164	128	PF-26	160		
OM-112	167	P-53	110	P-165	128	PF-27	160		
OM-113	167	P-54	123	P-166	128	PF-28	160		
OM-114	167	P-55	123	P-170	127	PF-29	160		
OM-136	165	P-56	122	P-171	127	PF-30	160		
OM-137	165	P-57	122	P-172	127	PF-31	160		
OM-138	165	P-58	122	P-173	127	PF-32	160		
OM-139	165	P-59	122	P-191	129	PF-33	160		
OM-140	166	P-61	119	P-192	129	PF-34	160		
OM-141	166	P-62	119	P-193	129	PF-35	160		
OM-142	166	P-63	119	P-194	129	PF-36	160		
OM-143	166	P-64	119	P-195	129	PF-37	160		
OM-144	166	P-65	126	P-196	129	PF-38	160		

Nummernverzeichnis		Alphanumerical index		Indice alfanumerico		Indice alfanumerico		Index alphanumériques	
Articolo	Pagina	Articolo	Pagina	Articolo	Pagina	Articolo	Pagina	Articolo	Pagina
PF-40	161	PH-112	150						
PF-41	161	PH-113	150	VS-20	311				
PF-43	161	PH-114	150	VS-26	311				
PF-44	160	PH-120	146	VS-30	311				
PF-46	161	PH-121	146						
PF-48	161	PH-122	146	WG-10	205				
PF-49	161	PH-123	146	WG-12	205				
PF-50	161	PH-124	146	WG-14	205				
PF-51	161	PH-125	146						
PF-52	161	PH-127	147						
PF-62	161	PH-128	147						
PF-63	161	PH-129	147						
PF-64	161	PH-130	153						
		PH-132	149						
PH-38	141	PH-133	149						
PH-39	141	PH-134	149						
PH-40	142	PH-140	151						
PH-41	142	PH-141	151						
PH-42	142	PH-142	151						
PH-43	142	PH-143	151						
PH-44	142	PH-144	151						
PH-45	142	PH-145	151						
PH-48	141								
PH-52	142	PO-50	154						
PH-53	145	PO-51	154						
PH-54	147	PO-52	154						
PH-58	153	PO-55	154						
PH-59	146	PO-56	154						
PH-61	141	PO-59	144						
PH-62	141	PO-85	154						
PH-63	141	PO-86	154						
PH-64	141	PO-87	154						
PH-65	145	PO-89	144						
PH-66	145	PO-97	148						
PH-67	145	PO-97L	148						
PH-68	145	PO-99	148						
PH-69	145	PO-99L	148						
PH-70	142	PO-104	144						
PH-71	147	PO-105	144						
PH-72	146								
PH-73	145	SC-1	74						
PH-74	142	SC-2	74						
PH-75	146	SC-5	74						
PH-76	146	SC-9	74						
PH-77	147	SC-12	74						
PH-78	142								
PH-79	147	TG-10	223						
PH-80	152	TG-11	212, 223						
PH-81	152	TG-12	223						
PH-82	152	TG-20	223						
PH-83	152	TG-21	223						
PH-84	152	TG-22	223						
PH-85	147	TG-23	212, 223						
PH-90	147	TG-30	224						
PH-95	146	TG-31	224						
PH-96	146	TG-32	224						
PH-97	146	TG-40	224						
PH-99	153	TG-41	224						
PH-100	153								
PH-101	150	TS-50	294						
PH-102	150	TS-101	314						
PH-103	150	TS-102	314						
PH-104	150	TS-103	314						
PH-106	149	TS-104	314						
PH-107	149								
PH-108	149	VH-20	279						
PH-109	150	VH-21	279						
PH-110	150	VH-23	279						
PH-111	150	VH-40	278						

Bontempi[®]
Chirurgische Instrumente

BONTEMPI
CHIRURGISCHE INSTRUMENTE

BMED Srl - Via Mincio, 166
47842 San Giovanni in Marignano RN

T +39 0541 1799990
F +39 0541 1794330
bmedsurgery.it / info@bmedsurgery.it